



ADMINISTRATION REPORT **REZONING & PLAN AMENDMENT** GARNEAU



Recommendation: That Bylaw 19766 the Garneau Area Redevelopment Plan and Charter Bylaw 19767 to amend the Zoning Bylaw from (RA7) Low Rise Apartment Zone to (DC2) Site Specific Development Control Provision be APPROVED.

Administration is in **SUPPORT** of this application because:

- proposes a moderate increase in building mass on a site zoned for low rise apartment buildings;
- it increases residential density within a Major Node as identified in City Plan;
- respects the height transition in the Garneau Area Redevelopment Plan; and
- locates a mid rise building near to the University of Alberta and local amenities.

Report Summary

This land use amendment application was submitted by Green Space Alliance on November 23, 2020 on behalf of Pinto Properties. This application proposes to change the designation of a large corner lot from the (RA7) Low Rise Apartment Zone to a (DC2) Site Specific Development Control Provision to allow for:

- A maximum height of 23.0 metres (approximately 6 storeys);
- A maximum Floor Area Ratio of 3.7;
- Up to 96 residential dwellings; and
- Ground oriented dwellings fronting 86 Avenue and 108 Street.

This proposal is in alignment with the applicable policies of CityPlan by promoting compact, mixed use development within a major node.

The proposal also generally aligns with the Garneau Area Redevelopment Plan which designates the site as appropriate for medium density housing. However, an amendment to Policy 2.1 and the area of application of the medium rise apartments within the plan is required to allow for 6 storey development on this site. Amendments to three land use maps are also required as part of this application.

The Application

1. BYLAW 19766 to amend Policy 2.1 and the "area of application" for medium rise apartments in the Garneau Area Redevelopment Plan. Policy 2.1 of the Garneau Area Redevelopment Plan currently limits development within Sub-Area 2 of the plan to Apartments with a maximum height of 4 storeys, and stacked row housing. This policy is proposed to be amended to allow for development of up to 6 storeys at 10742 - 86 Avenue NW.

Three maps are also proposed to be amended to reflect the change in zoning as follows:

- Schedule C, General Land Uses, would redesignate the site from "Special Public Service" to "Medium Rise Apartments;"
 - Schedule J, Detailed Land Use Sub Area 2, would redesignate the site from "Low Rise Apartment" to "Medium Rise Apartment;" and
 - Schedule Q, Proposed Zoning, would redesignate the site from the (RA7) Low Rise Apartment Zone to the (RA8) Medium Rise Apartment Zone.
2. CHARTER BYLAW 19766 to change the zoning from the (RA7) Low Rise Apartment Zone to a (DC2) Site Specific Development Control Provision. The proposed (DC2) Site Specific Development Control Provision would allow for a building with the following characteristics:
 - A maximum height of 23.0 metres (approximately 6 storeys);
 - A maximum Floor Area Ratio of 3.7;
 - Up to 96 residential dwellings; and
 - Ground oriented dwellings fronting 86 Avenue and 108 Street.

Site and Surrounding Area

The site consists of a large corner lot located north of 86 Avenue and east of 108 Street NW within the Garneau neighborhood. Abutted by road right-of-ways on the north, south and west, only one property, a 4 storey apartment building, is directly adjacent to this site to the east. The north west corner of this site is transected by an underground utility easement which supports EPCOR infrastructure that is located deep underground (see figure in Planning Analysis below).

The surrounding area is predominantly zoned (RA7) Low Rise Apartment Zone and consists primarily of low rise apartments and single detached houses with high rise towers located a block to the north on Saskatchewan Drive, zoned (RA9) High Rise Apartment Zone and (DC2) Site Specific Development Control Provisions. Across the lane to the north east of the site is a future park space, zoned (AP) Public Parks Zone, which is scheduled to be constructed as part of the Garneau Neighbourhood Renewal which commenced this summer.

High frequency transit is accessible from both 109 Street NW, approximately 200 metres to the west, and Whyte Avenue just over 400 metres to the south. On street bike lanes, connected to the broader City bike network, are located a block to the south on 85 Avenue NW.



AERIAL VIEW OF APPLICATION AREA

SUBJECT SITE	<ul style="list-style-type: none"> • (RA7) Low Rise Apartment Zone 	<ul style="list-style-type: none"> • Vacant lot (previously three single detached homes)
CONTEXT		
North	<ul style="list-style-type: none"> • (RA7) Low Rise Apartment Zone • (AP) Public Parks Zone 	<ul style="list-style-type: none"> • 4-storey residential apartment building • Future public park
East	<ul style="list-style-type: none"> • (RA7) Low Rise Apartment Zone 	<ul style="list-style-type: none"> • Three single detached dwellings & the Granite Curling Club
South	<ul style="list-style-type: none"> • (RA7) Low Rise Apartment Zone 	<ul style="list-style-type: none"> • 3-storey residential apartment building, single detached housing, and the Muslim Community of Edmonton Mosque
West	<ul style="list-style-type: none"> • (RA7) Low Rise Apartment Zone 	<ul style="list-style-type: none"> • 4 and 3 storey residential apartment buildings



VIEW OF SITE FROM THE SOUTH WEST SHOWING THE SINGLE DETACHED HOUSES WHICH WERE DEMOLISHED IN 2020.

Planning Analysis

This application proposes to allow for a larger mid-rise building on a site which is located within an area that allows for the development of low rise apartment buildings. While this application represents an increase in development intensity on a site within the neighbourhood, rather than on the edge, the site context and proposed DC2 Provision represent a development which is contextually sensitive and appropriate at this location.

LAND USE COMPATIBILITY

The site and surrounding area is currently zoned (RA7) Low Rise Apartment Zone which allows for residential development up to 16.0 m in height, or approximately 4 storeys. This is reflected in the majority of surrounding buildings which are generally low rise apartments.

The proposed DC2 Provision would allow for the development of a 6 storey, 3.7 Floor Area Ratio (FAR), residential apartment building with five row-house style units at grade, fronting both 86 Avenue and 108 Street. Commitment has been made to ensure that there is a mix of dwellings in this building by requiring a minimum of 25% of dwellings to have 2 or more bedrooms, and at least 9 dwellings to have a floor area greater than 100 m². Of these dwellings, five will be required to be family oriented dwellings providing certainty that this building will provide a variety of unit types and sizes.

The design of the building is intended to allow for the core of each floor to provide common amenity areas for residents in addition to a large rooftop amenity area. The DC2 Provision requires a minimum of 200 m² common indoor amenity area with at least 50 m² that is specifically designed for children. This provision of amenity within the building is the primary factor which has resulted in a larger floorplate being proposed than is typical for a 6 storey building.

While a building of this size is a notable increase in building mass and scale at this site, it is not incompatible with the surrounding development as the DC2 provision provides appropriate setbacks and stepbacks from adjacent buildings. A summary of the current RA7 zone, the comparable (RA8) Medium Rise Apartment Zone and the proposed DC2 Provision can be found in the *Zoning Comparison* section below.



MASSING MODEL OF THE PROPOSED DC2 PROVISION SHOWING THE DEVELOPMENT TO SCALE WITH EXISTING BUILDINGS FROM THE SOUTH WEST (RIGHT) AND SOUTH EAST (LEFT)

The building mass from a 6 storey building will produce additional impacts on these properties in the form of a larger shadow and reduced privacy due to increased opportunities for overlook from the proposed building. That being said, it is important to note that these impacts would be present should the site be redeveloped under the current zoning where a 4 storey building could be constructed. Separation between properties from existing road right-of-ways, and the proposed setbacks and stepbacks of the DC2 Provision mitigate much of the impact of the proposed increase in density at this location. Appendix 1 shows potential shadows on equinoxes, the winter solstice, and summer solstice in comparison to the current RA7 Zone.

While the scale and intensity of development proposed by this DC2 Provision is more in line with what would be expected on a major corridor, such as 109 Street to the west, the site is unique in that there is a utility easement which somewhat inhibits development. This easement, transecting the north west corner of the site, is located at what would be the minimum rear setback of the RA7 or RA8 zones. Development in the RA7 or RA8 would require a building constructed with greater setbacks in this corner to manage the requirements of this easement.

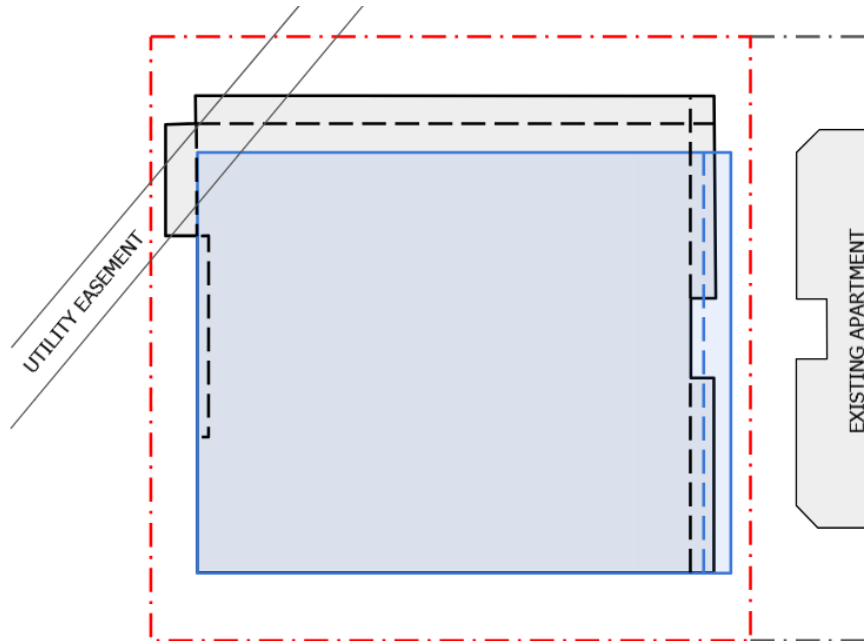

A COMPARISON OF SETBACKS, AND STEPBACKS WITH DASHED LINES, OF THE PROPOSED DC2 PROVISION (IN GREY) AND THE RA7 AND RA8 ZONES (IN BLUE) IN RELATION TO THE UNDERGROUND UTILITY EASEMENT AND THE ADJACENT APARTMENT BUILDING TO THE EAST.

As the north property line abuts a lane, which creates separation between the site and the building to the north, the DC2 provision proposes a reduction in rear setback to allow for the building to straddle this easement. This allows for the building to locate footings on either side of the easement to ensure the underground pipe is not disturbed or damaged, as well as create a more efficient building design. The reduction in rear setback does result in the proposed building being located closer to the apartment across the lane to the north, however; this building is oriented primarily towards 108 Street NW and presents limited openings and balconies to the south mitigating the potential impacts of this reduction. Even with this reduction in rear setback, the facades of both buildings will still be 11 metres apart from one another.

A reduction in setback, compared to the RA7 and RA8 zones, is also required to the west to appropriately manage the easement. A portion of the building would be allowed to be located 1.0 metre from the property line, but only for the lower floors of the building as the setback increases to the expected 3.0 metres above 7.0 metres in height.

The most sensitive interface of this building is the east facade where an existing 4 storey apartment building is located next door. The RA7 and RA8 Zones would allow for the development of a building which is 1.2 metres from that property line with a setback increasing this to 3.0 metres at 10.0 metres in height. The DC2 Provision improves on this interface through a larger setback of 2.5 metres which increases to 4.5 metres above 13 metres in height. In addition to these increased setbacks, balconies are not permitted to project into the 2.5 metre setback to maintain separation between the buildings, windows are required to be located away from the neighbouring property's windows, and the portion of the building which is directly across from the neighbouring building's balconies has a greater setback. To ensure privacy of both the existing building and the proposed development, a landscaped buffer is also required in this setback. In general, this interface has been substantially improved compared to that of the standard zones in the Zoning Bylaw.



SOUTH (RIGHT) AND EAST (LEFT) ELEVATIONS OF THE DC2 PROVISION SHOWING THE RESTRICTIONS ON BALCONIES AND OPENINGS ON THE LOWER 13 METRES OF THE EAST FACADE FACING THE NEIGHBOURING BUILDING

On the whole, this application represents an appropriate increase in development rights while respecting surrounding properties. The increase in mass and reductions in setback requirements for this DC1 Provision are offset by the context of the property and appropriate efforts to improve its interface to its most impacted neighbour have been made.

ZONING COMPARISON SUMMARY

	RA7 Zone <i>Current</i>	RA8 Zone <i>Comparable</i>	DC2 Provision <i>Proposed</i>
Maximum Height	14.5 m flat roof/ 16.0 m pitched roof	23.0 m	23.0 m
Maximum Floor Area Ratio (FAR)	2.5 ^x	3.3 ^x	3.7
Maximum Density	No maximum	No maximum	96 Dwellings

Minimum Setbacks and Stepbacks			
Lane / North	7.5 m	7.5 m	4.0 m 5.5 m above 15.0 m
108 St / West	3.0 m	3.0 m	1.0 - 3.0 m ^Y 3.0 m above 7.0 m
86 Ave / South	4.5 m	4.5 m	4.5 m
East	1.2 m 3.0 m above 10.0 m	1.2 m 3.0 m above 10.0 m	2.5 - 4.5m ^Z 4.5 m above 13 m
Commercial Uses	Limited Commercial Uses at Grade	Limited Commercial Uses at Grade	None
Notes:			
<p>^X FARs shown are permitted when a minimum of 10% of dwellings in the building are greater than 100 m² and the average number of bedrooms in these dwellings is at least three. As the proposed DC2 Provision proposes similar requirements, these bonuses FARs are appropriate comparables.</p> <p>^Y The west setback is reduced to 1.0 m for the northern portion of the west facade in order to straddle the underground easement which crosses the site.</p> <p>^Z The east setback is increased from 2.5 to 4.5 metres for a portion of the east facade which is located directly across from the balconies of the adjacent apartment building to the east.</p>			

PLANS IN EFFECT

Garneau Area Redevelopment Plan

The overall development concept of the Garneau Area Redevelopment Plan (ARP), adopted in 1982, is designed to accommodate city growth through redevelopment while ensuring it is compatible with the existing residential character of the neighbourhood. The general policies of the ARP manage this growth by restricting high rise development to the north and east edges of the neighbourhood (Policy G.3) and managing an appropriate transition from high rise to low rise apartment buildings. This is reflected through Policy G.4 which graphically shows the intended transition in height below.

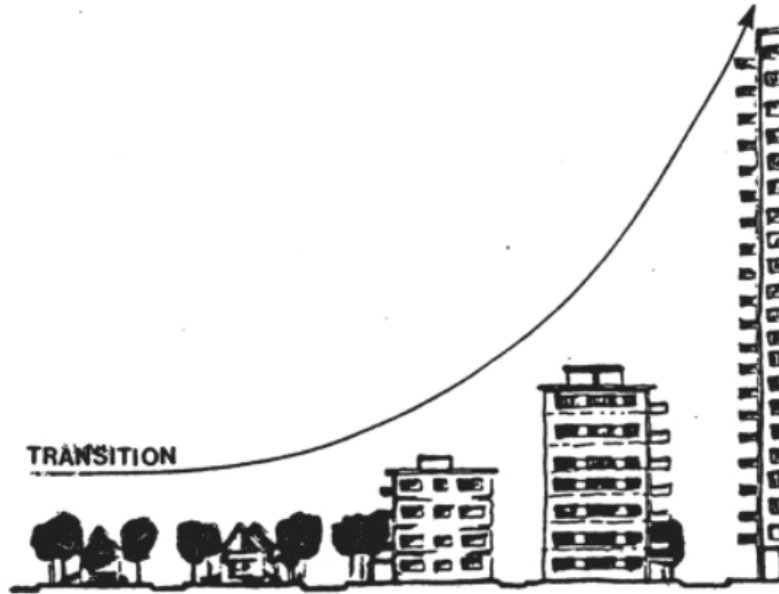

IMAGE FROM THE GARNEAU ARP SHOWING APPROPRIATE TRANSITION IN HEIGHTS

While this site does not share a property line with a high rise tower, the general intent of this transition policy is maintained due to the property's proximity to tower development, just north of the rail right-of-way, and the surrounding RA7 zoning.

This site is located within Sub-Area 2 of the ARP which is described as "primarily a medium density residential zone" where "walk up apartment buildings predominate with pockets of single family dwellings interspersed among them." This sub-area has high rise apartment buildings located north on Saskatchewan Drive overlooking the river valley (See Appendix 2 for Context Map).

The plan describes this area as appropriate for medium density development, and encourages diversity in housing, but the policies which govern this sub-area restrict development to 4 storey apartments or stacked row housing. The (RA7) Low Rise Apartment Zone is applied to the majority of the properties within Sub-Area 2. This is demonstrative of the more modest definition of "medium density development" when the Garneau ARP was written compared to current expectations of medium density.

This application does propose to amend policy 2.1 to allow for 6 storey development; however, it is important to note that the general residential policies of the ARP would still be maintained. This site is located approximately 50 metres from the rail right-of-way which is intended to be a break between high rise buildings located on Saskatchewan Drive and the interior of the neighbourhood which allows for the development of low rise apartments. As it would be unreasonable to expect a single row of RA8s to be located along this RoW, this block which is adjacent to the right-of-way should be considered the transition zone between the high rises to the north and low rise apartments in the interior of the neighbourhood. As a result, this site is an appropriate location for medium density development.

Allowing for 6 storey development on this site would meet the land use objectives of Sub Area 2 as well as be in alignment with the general policies of the Garneau ARP.

While this application conforms with the policy statements in the Garneau ARP, an amendment is required to update Schedule J to redesignate this site as a Medium Rise Apartment, and to update to land use maps (Schedules C and Q) to reflect the proposed rezoning as outlined in The Application section at the beginning of this report.

Residential Infill Guidelines

The Residential Infill Guidelines (RIG) consider buildings from five to eight storeys to be Mid Rise Apartments. According to the RIGs, Mid Rise Apartment buildings should be located in the City's key activity centres, areas adjacent to LRT Stations or at existing regional, or community level shopping centre sites. Exceptions are made for "Large Sites" that are over one hectare in size or on other sites where the specific context of the site warrants consideration of Mid Rise buildings. These would be sites that have direct access to an arterial or collector road, and are isolated from small scale residential development by other land uses such as existing medium/large scale residential development, commercial development, a large park site or natural area. This site does not align well with this locational criteria except for its proximity to the University of Alberta.

Administration recognizes that the locational criteria for Mid Rise Apartments in the Residential Infill Guidelines is likely too restrictive, when there are multiple high rise developments within a block north of the site. As such, these guidelines are not an effective reference tool in this case. Aside from locational guidelines, the proposed RA8 Zone aligns fairly well with the guidelines for parking, built form and design and site design and streetscape.

City Plan Alignment

City Plan, the new Municipal Development Plan, provides high level policy for the long term growth of Edmonton. One key piece of this plan is to accommodate all of this future growth within Edmonton's existing boundaries, with no further annexations or expansions. To do this, 50% of all new residential units are intended to be created at infill locations, focusing on key nodes and corridors.

The University-Garneau area is identified as one of six Major Nodes located across the city. While there are no specific boundaries identified for these Major Nodes, they are considered to be approximately 2 km across. Located 1.4 km from the University of Alberta Health Sciences LRT Platform, this site is considered to be within this major node.

From a high level policy perspective, it is concluded that this proposed mid-rise building is in support of the infill objectives of the City Plan.

PUBLIC CONTRIBUTIONS

C599 - Community Amenity Contributions

A minimum required contribution for this proposal of \$87,896.13 is required to comply with City Policy C599 Community Amenity contributions in Direct Control Provisions. The proposed application complies with this policy through the provision of the following amenities:

- 5 three bedroom dwellings designed to be suitable for families;
- Subsidized transit passes building occupants at a rate of 50% for a minimum of 10 years; and
- \$90,000 towards enhancements to the “Wedge Park” to the north east of the site.

Technical Review

All comments from affected City Departments and utility agencies have been addressed.

Transportation

A Transportation Demand Management (TDM) Study was submitted in support of this application. The study recommended a variety of TDM measures that are expected to heavily encourage residents to use non-vehicle modes for travel, and these have been included in the proposed DC2 Provision:

- vehicle parking will be limited to a maximum of seven stalls, of which at least two must be car share spaces;
- the owner must provide secure bicycle parking at double the rate required by the Zoning Bylaw, and must also provide a bicycle repair and maintenance station on-site; and
- the owner will be required to provide transit passes to building occupants at a subsidized rate of 50% of the purchase price for a minimum of 10 years.

Increasing the site density while restricting the on-site vehicle parking allowance to seven stalls will encourage residents to utilize non-vehicle modes of travel. Administration recognizes that this could also inadvertently lead to added pressure put on the curbside parking supply in the neighbourhood.

The City is currently undertaking a broad review of how on-street parking is managed to ensure it is aligned with the recent removal of on-site parking minimums (Open Option Parking) and the direction in ConnectEdmonton and the City Plan to begin treating on-street parking as a strategic public asset.

Garneau Neighbourhood Renewal construction began in July 2021 and is expected to be complete in 2022. The plans include measures to significantly improve the pedestrian and bicycling experience in Garneau, manage traffic speed, and enhance connections to and through the open spaces. Within the vicinity of this site, a new sidewalk will be constructed along the north side of 86 Avenue NW, and a new speed hump along the street will be installed to slow drivers. This site will also have excellent access to the Rail Trail shared-use path that will ultimately connect Gateway Boulevard to 109 Street.

Drainage

On-site stormwater management will be required to mitigate the impacts of development that would be allowed under the proposed zone. As a result, redevelopment of this site would not have a significant impact on the existing drainage infrastructure in the area.

EPCOR Drainage-owned facilities protected by URW exist within the northwest portion of the subject area. EPCOR has agreed to work with the applicant's consultant through the design, construction, and servicing process to address any issues regarding potential encroachment with EPCOR's infrastructure.

Community Engagement

<p>PRE-APPLICATION NOTIFICATION June 23, 2020</p>	<ul style="list-style-type: none"> ● Number of recipients: 89 <p><u>As reported by applicant</u></p> <ul style="list-style-type: none"> ● Number of responses: 20 ● Number of responses seeking more information: 11 ● Number of responses in non-support: 7 ● Comments included: <ul style="list-style-type: none"> ○ Concerns with height and density ○ Parking and traffic concerns ○ Impacts to drainage and wastewater systems ○ Excess of student housing in area ○ Concerns the proposal is not in character with the neighbourhood
<p>ADVANCE NOTICE January 4, 2021</p>	<ul style="list-style-type: none"> ● Number of recipients: 87 ● Number of responses with concerns: 19 ● Common comments included: <ul style="list-style-type: none"> ○ Purchased home based on 4 storey maximum height in area ○ Concern regarding increased density ○ Concern with increased building mass ○ Concern this application will set a precedent for larger buildings in area ○ The proposal is not consistent with the Garneau ARP ○ Setbacks are too small compared to existing buildings ○ Sun shadow impacts ○ Privacy and view impacts ○ Parking and traffic

	<ul style="list-style-type: none"> o Noise, garbage and crime o Concerns the proposal is not in character with the neighbourhood
<p>PUBLIC ENGAGEMENT SESSION (ENGAGED EDMONTON WEBSITE) March 22, 2021 to April 6, 2021</p>	<p>engaged.edmonton.ca/108StreetAltairus</p> <ul style="list-style-type: none"> ● Aware: 112 ● Informed: 40 ● Engaged: 8 ● Opposed: 33 ● Support: 1 ● No position:1 ● Common comments included: <ul style="list-style-type: none"> o The proposal is not consistent with the Garneau ARP o Purchased home based on 4 storey maximum height in area o General non-support of the proposal o Concerns regarding traffic and parking o Development does not propose enough parking o Sun shadow impacts o Concerns regarding number of proposals in area o Concerns the proposal is not in character with the neighbourhood ● See Appendix 3 for a full “What We Heard” Report
<p>WEBPAGE</p>	<p>edmonton.ca/garneauplanningapplications</p>

Conclusion

Administration recommends that City Council **APPROVE** this application.

APPENDICES

- 1 Sun/Shadow Analysis
- 2 Context Plan Map
- 3 “What We Heard” Public Engagement Report
- 4 Application Summary

CONTEXT PLAN MAP

Garneau

SCHEDULE J Detailed Land Use Sub Area 2

Area Redevelopment Plan

-  Low Rise Apartment
-  Medium Rise Apartment
-  High Rise Apartment
-  Urban Services
-  Public Parks
-  Mixed Use Development - Commercial and Residential
-  Special Public Service

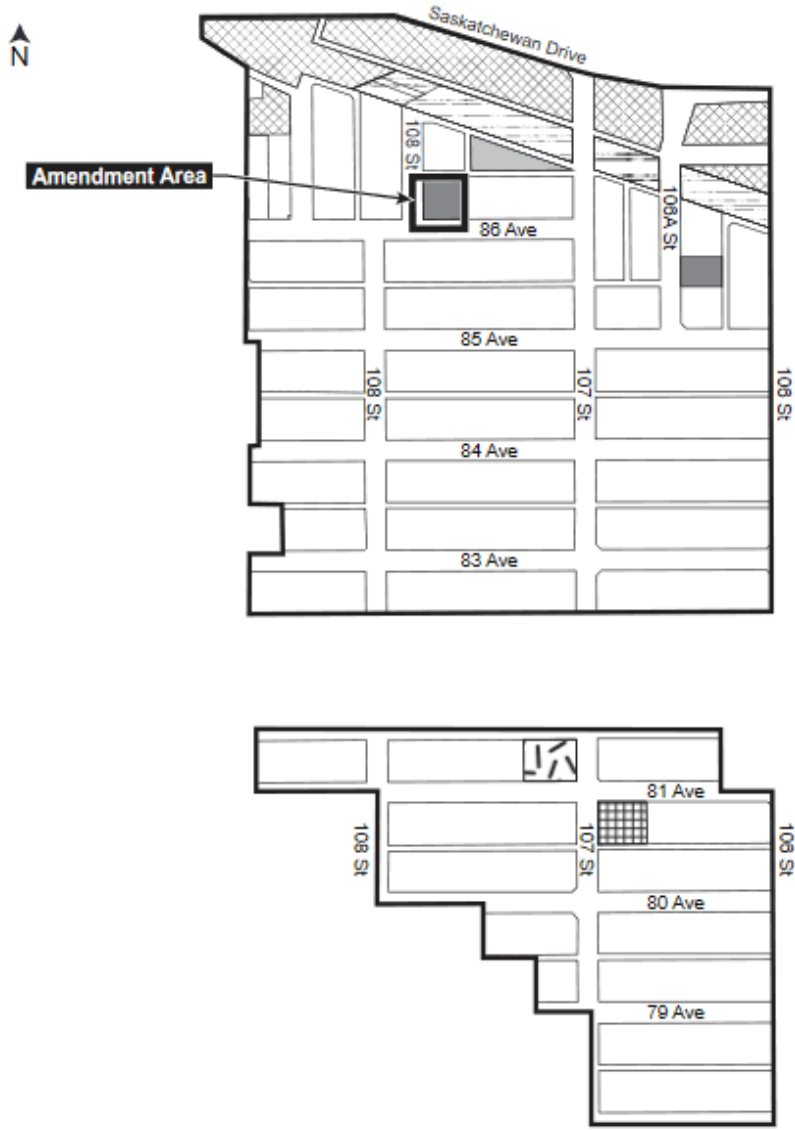

SUN SHADOW ANALYSIS

EQUINOXES - March & September

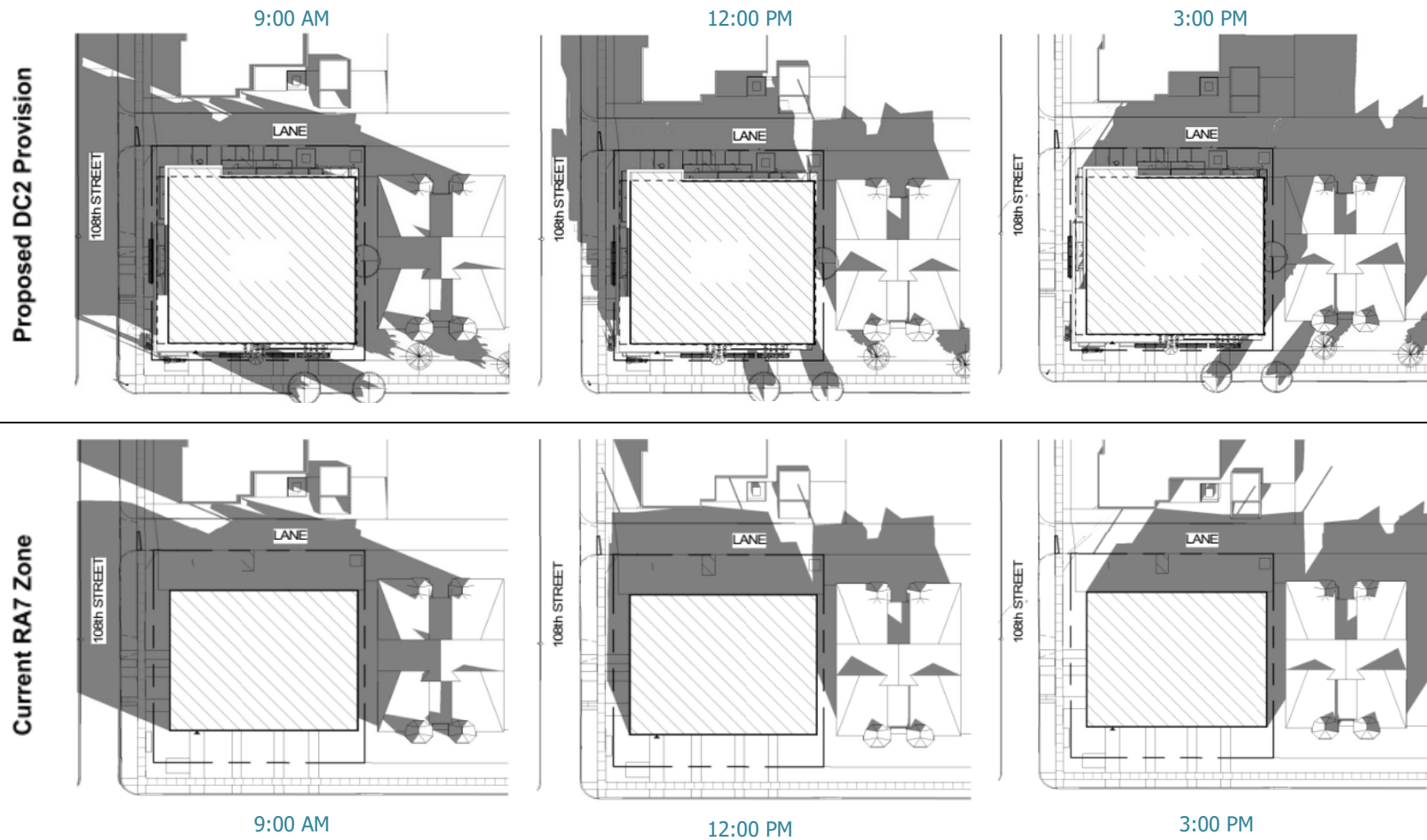

SUMMER SOLSTICE - June

Proposed DC2 Provision

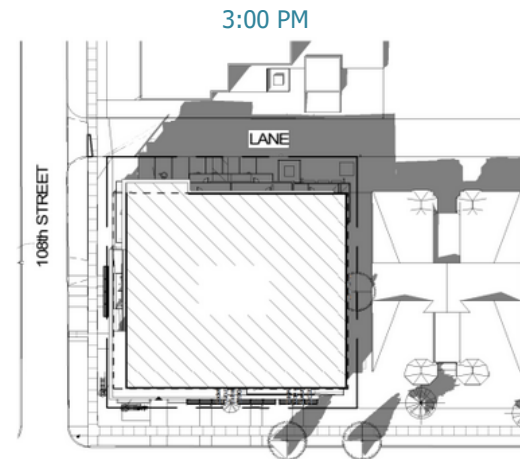
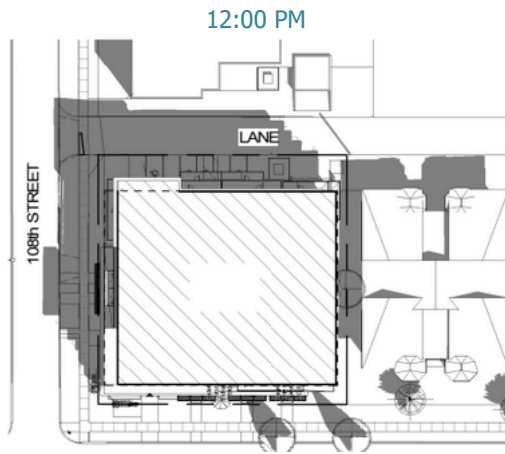
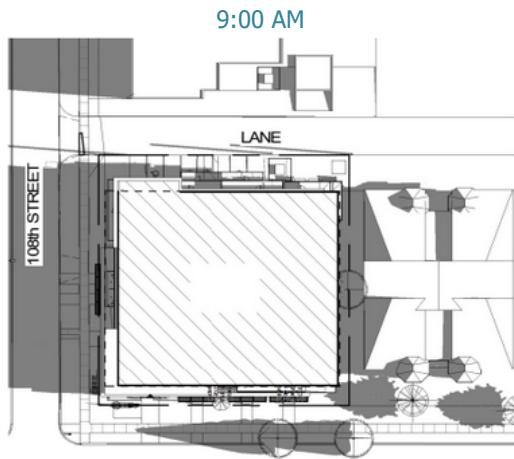

Current RA7 Zone

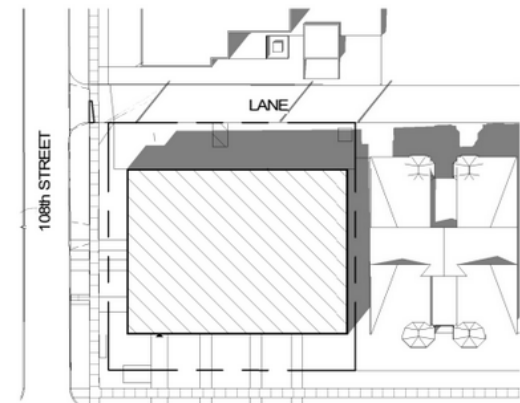
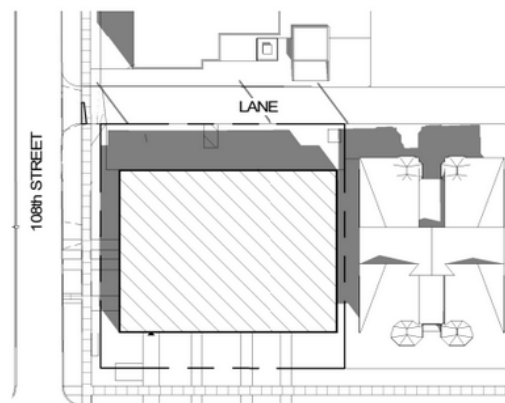
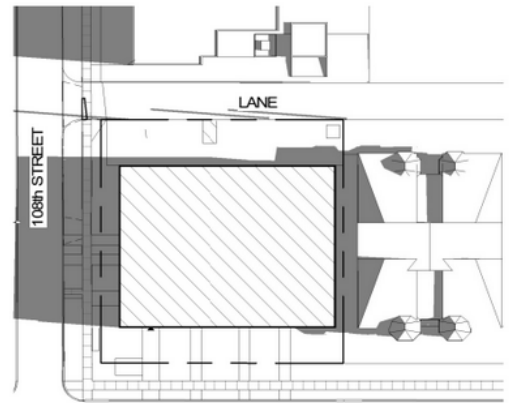

WINTER SOLSTICE - December

Proposed DC2 Provision

9:00 AM

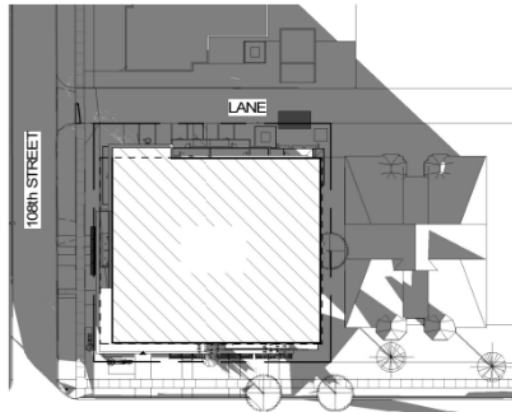

12:00 PM

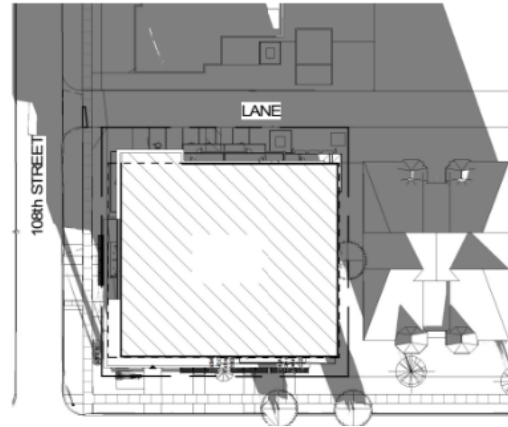

3:00 PM

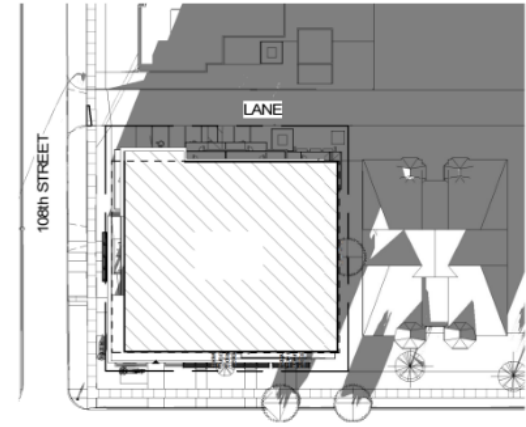

Current RA7 Zone

9:00 AM

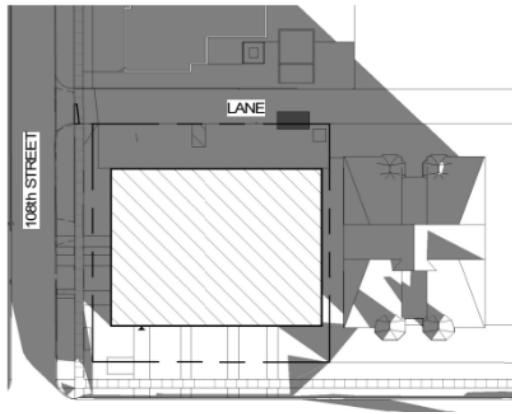

12:00 PM

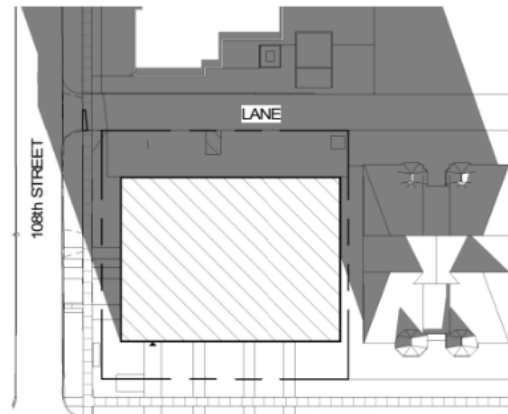

3:00 PM

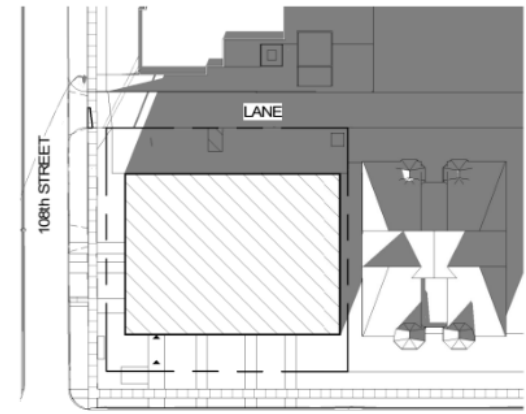

WHAT WE HEARD REPORT

Rezoning Engage Edmonton Feedback Summary

LDA20-0414 - Garneau

PROJECT ADDRESS: 10742 - 86 Avenue NW

PROJECT DESCRIPTION: The application proposes to rezone the site from the (RA7) Low Rise Apartment Zone to a (DC2) Site Specific Development Control Provision to allow for a residential apartment building with the following characteristics:

- a maximum height of 23 metres (approximately 6 storeys);
- a maximum floor Area Ratio of 3.9;
- Up to 97 residential dwellings; and
- Ground oriented dwellings fronting 86 Avenue and 108 Street.

An associated application has been made to amend the Garneau Area Redevelopment Plan (ARP) to update the land use maps to reflect the proposed zoning and add a new subpoint to Policy 2.1 to allow for development up to 6 storeys at this site.

PROJECT WEBSITE: https://www.edmonton.ca/residential_neighbourhoods/neighbourhoods/10742-86-avenue-nw.aspx

ENGAGEMENT FORMAT: Online Engagement Webpage - Engaged Edmonton engaged.edmonton.ca/108StreetAltairus

ENGAGEMENT DATES: March 22, 2021 - April 6, 2021

NUMBER OF VISITORS:

- Aware: 112
- Informed: 40
- Engaged: 8

* See “Web Page Visitor Definitions” at the end of this report for explanations of the above categories.

TYPE OF ENGAGEMENT	DATE	RESPONSES/ RECIPIENTS
Advance Notice from the City informing residents of the rezoning application	Dec 23, 2020	Recipients: 87 Responses with concerns: 26
Garneau Planning Applications Webpage	Feb 10, 2021	N/A
Public Engagement Notice from the City (Online Engaged Edmonton)	March 17, 2021	Recipients: 88
Public Engagement, City Event (Online Engaged Edmonton)	March 17, 2021 - April 6, 2021	Responses opposed: 7 Responses in support: 1 Responses in neutral position: 1

ABOUT THIS REPORT

Information in this report includes responses to the advanced notices and feedback gathered through the Engaged Edmonton platform between March 22, 2020 - April 6, 2021. This report will be shared with those who emailed the file planner, and/or provided an email address on the Engaged Edmonton website, as well as with the applicant and the Ward Councillor. Feedback will also be summarized in the report to City Council if/when the proposed rezoning advances to a future City Council Public Hearing for a decision.

A full transcript of comments is available for review at engaged.edmonton.ca/108StreetAltairus.

ENGAGEMENT FORMAT

The engagement session was an online format where attendees were able to view a website with information about the proposed development, the rezoning and planning process, and contact information for the file planner.

The comments are summarized by the main themes below with the number of times a similar comment was made by participants recorded in brackets following that comment.

WHAT WE HEARD

OVERALL SUMMARY OF 35 COMMENTS RECEIVED		
Opposed: 33	Support: 1	Neutral: 1

SUMMARY OF COMMENTS

A full transcript of comments can be found at engaged.edmonton.ca/108StreetAltairus.

General:

- General non-support of the proposal (x9)
- Purchased home based on understanding of current zoning of this property (x5)
- Concern that the applicant is identifying neighbouring properties as 5 storey buildings when it is a 4 storey building where one unit has a loft (x4)
- There are four rezoning applications nearby and this needs to be accounted for when reviewing these applications (x4)
- Concerns regarding noise from new residents (x4)
- Concern this application will set a precedent for the neighbourhood (x3)
- This building will negatively impact the quality of life for existing residents of the neighbourhood (x2)
- A six storey building will change the character of the neighbourhood (x2)
- Concerns regarding increased crime (x2)
- Insurance for existing buildings is prohibitively expensive and this proposal will make it more expensive for nearby residents
- City needs to consider a post-COVID world where work from home is common and people will need work space at home
- Developer has overpaid for land with the assumption they would get it back through rezoning
- The proposal will negatively impact the enjoyment of adjacent properties
- There is too much hardscaping/coverage shown on the site plan
- Concerns regarding garbage collection for the building
- Concern regarding duration and impact of construction

- There are no other six storey buildings in the area
- Proposal is out of context for the neighbourhood
- Proposal will block views from existing buildings
- Like proposed building aesthetics/design
- Proposal will remove recreation land

Parking and Traffic:

- General concerns regarding traffic and parking (x11)
- Development does not propose enough parking (x5)
- Parking in area is already problematic due to nearby curling club/mosque (x2)
- The adjacent lane is narrow and in poor condition (x2)
- Development should provide at least a 1 to 1 parking space to bedroom ratio
- Constructing a building without parking will make it unmarketable
- Concern regarding increases for commercial/moving trucks
- Already minimal on-street parking in the area

Height, Massing & Density:

- Concerns regarding sun-shadow impacts (x11)
- Concerns regarding the proposed increase in density (x7)
- Concerns regarding the proposed increase in height (x5)
- Concerns regarding proposed setbacks (x5)
- Proposal will put 12 units in the adjacent building into shadow
- This application is not consistent with surrounding uses
- Building is too large for the neighbourhood/street

Neighbourhood Context:

- Concern the existing City infrastructure will not be able to support this development (x2)
- Garneau is a quiet area of single detached houses and low rise apartments (x2)
- Neighbourhood is already overcrowded (x2)
- Residents here feel their homes/community are under attack by several projects in the area
- The City should be listening to existing neighbours rather than the demands of developers
- No need for gyms or yoga studios in the building due to proximity to Whyte Avenue
- There is not enough parkspace in the neighbourhood for families
- The property is not close enough to the LRT to justify it

City Policies, Guidelines & The Garneau Area Redevelopment Plan:

- Proposal is not consistent with the Garneau Area Redevelopment Plan (x14)

- Garneau Area Redevelopment Plan already provides enough opportunities for density in neighbourhood (x2)
- Garneau Area Redevelopment Plan is intended to support a mix of single detached dwellings and four storey walk ups
- Proposal is not consistent with the height transition strategy of the Garneau Area Redevelopment Plan
- Amendments to the Garneau Area Redevelopment Plan should not be approved

Web Page Visitor Definitions

Aware

An aware visitor, or a visitor that we consider to be 'aware', has made one single visit to the page, but not clicked any further than the main page.

Informed

An informed visitor has taken the 'next step' from being aware and clicking on something. We now consider the visitor to be informed about the project. This is done because a click suggests interest in the project.

Engaged

Every visitor that contributes on the page, either by asking questions or leaving a comment, is considered to be 'engaged'.

Engaged and informed are subsets of aware. That means that every engaged visitor is also always informed AND aware. In other words, a visitor cannot be engaged without also being informed AND aware. At the same time, an informed visitor is also always aware.

FUTURE STEPS:

- When the applicant is ready to take the application to Council:
 - Notice of Public Hearing date will be sent to surrounding property owners
 - Once the Council Public Hearing Agenda is posted online, you may register to speak at Council by completing the form at edmonton.ca/meetings or calling the Office of the City Clerk at 780-496-8178.
 - You may listen to the Public hearing on-line via edmonton.ca/meetings.
 - You can submit written comments to the City Clerk (city.clerk@edmonton.ca) or contact the Ward Councillor, Ben Henderson directly (ben.henderson@edmonton.ca).

IF YOU HAVE ANY QUESTIONS ABOUT THIS APPLICATION, PLEASE CONTACT:

Name: Andrew Sherstone

Email: andrew.sherstone@edmonton.ca

Phone: 780-442-0699



APPLICATION SUMMARY

INFORMATION

Application Type:	Plan Amendment, Rezoning
Bylaw & Charter Bylaw:	19766 & 19767
Location:	North of 86 Avenue NW and east of 108 Street NW
Address:	10742 - 86 Avenue NW
Legal Description(s):	Lot 10, Block 188, Plan 1922223
Site Area:	1611.888 m ²
Neighbourhood:	Garneau
Notified Community Organization(s):	The Garneau Community League of Edmonton
Applicant:	Green Space Alliance

PLANNING FRAMEWORK

Current Zone(s) and Overlay(s):	(RA7) Low Rise apartment Zone
Proposed Zone(s) and Overlay(s):	(DC2) Site Specific Development Control Provision
Plan(s) in Effect:	Garneau Area Redevelopment Plan
Historic Status:	None

Written By:	Andrew Sherstone
Approved By:	Tim Ford
Branch:	Development Services
Section:	Planning Coordination