

WASTE SERVICES UTILITY RATE FILING 2023-2024

Edmonton

CITY OF EDMONTON
NOVEMBER 2022



Page intentionally left blank

TABLE OF CONTENTS

INDIGENOUS LAND ACKNOWLEDGEMENT.....	5
EXECUTIVE SUMMARY.....	6
1. INTRODUCTION.....	8
2. ORGANIZATIONAL STRUCTURE.....	10
3. METHODOLOGY & KEY ASSUMPTIONS.....	12
4. OPERATIONAL PERFORMANCE.....	18
KEY PERFORMANCE METRICS.....	18
5. FINANCIAL RATE IMPACTS.....	19
6. FINANCIAL INDICATORS & RISK ALLOWANCE.....	21
6.1 UTILITY RATES.....	22
6.2 GENERAL COMMENTS FOR FINANCIAL INDICATORS.....	23
7. UTILITY SUMMARY SCHEDULE.....	25
8. OPERATIONS & MAINTENANCE.....	27
8.1 PERSONNEL.....	28
8.2 MATERIALS, GOODS & SUPPLIES.....	29
8.3 EXTERNAL SERVICES.....	30
8.4 FLEET SERVICES.....	32
8.5 SHARED SERVICES.....	33
8.6 INTRA-MUNICIPAL SERVICES.....	35
8.7 UTILITIES.....	36
8.8 INTRA-MUNICIPAL RECOVERIES.....	37
9. AMORTIZATION & INTEREST EXPENSE.....	38
9.1 DEFERRAL ACCOUNT BALANCES.....	40
10. REVENUE REQUIREMENT.....	42
10.1 NON-RATE REVENUE.....	43
10.2 CALCULATION OF RATE BASE.....	45
10.3 RETURN ON RATE BASE.....	46

11. CAPITAL BUDGET & FORECAST PLAN.....	47
11.1 CAPITAL PROJECT SUMMARY.....	47
11.2 CAPITAL PROJECT FINANCING SUMMARY.....	52
12. LANDFILL CLOSURE & RELATED LIABILITIES.....	53
13. SEGMENTED REPORTING - PROGRAM REVENUES & EXPENSES.....	56
13.1 REVENUES & EXPENSES BY REGULATED AND NON-REGULATED PROGRAM.....	58
13.2 REGULATED ACTIVITIES EXPENSE CHANGES.....	60
14. HISTORICAL TRENDS.....	63
APPENDIX A: OPERATING BUSINESS CASES & NEW FTE JUSTIFICATIONS.....	64
APPENDIX B: CAPITAL FUNDING REQUESTS & CAPITAL PROFILES.....	70

INDIGENOUS LAND ACKNOWLEDGEMENT

Edmonton is located within Treaty 6 Territory and within the Métis homelands and Métis Nation of Alberta Region 4. We acknowledge this land as the traditional territories of many First Nations such as the Nehiyaw (Cree), Denesuliné (Dene), Nakota Sioux (Stoney), Anishinaabe (Saulteaux) and Niitsitapi (Blackfoot).

The City of Edmonton owes its strength and vibrancy to these lands and the diverse Indigenous peoples whose ancestors' footsteps have marked this territory as well as settlers from around the world who continue to be welcomed here and call Edmonton home.

Together we call upon all our collective honoured traditions and spirits to work in building a great city for today and future generations.

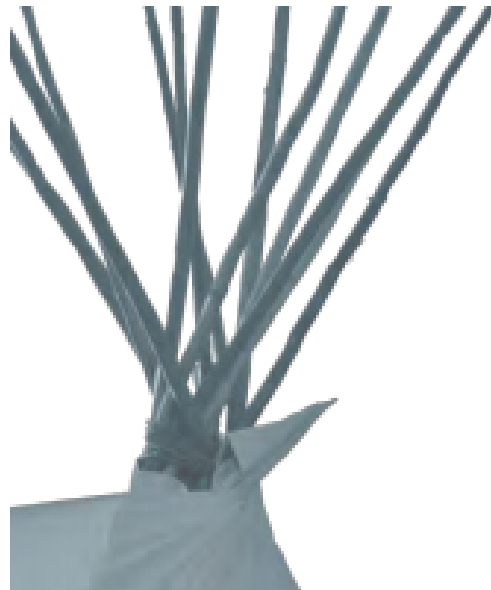

EXECUTIVE SUMMARY

The Waste Services utility is an essential part of The City Plan and key to enhancing sustainability while supporting Climate Resilience through innovation and partnership. The goal of the utility is to lead by example by focusing on waste reduction activities, waste diversion programs, and supporting and encouraging Edmontonians, businesses and institutions in their waste management practices. Programs that promote waste prevention, waste reduction, reuse of materials, and circular economy innovations through a Zero Waste Framework contribute to the City's Corporate Outcomes and the City's waste diversion goals established in the 25-year Waste Strategy.

Over the next four years, the Waste Services utility will:

- Maximize the promotion of policy, regulation, partnerships and market creation over direct practice and market entry for non-regulated business sectors;
- Manage the risk to diversion targets through balanced portfolios of insourced and outsourced activities for regulated business sectors;
- Build resident behaviour agility to meet evolving system requirements related to changes in market availability and other cost drivers.

Following these guiding principles the utility will strive to achieve the following goals:

Make Transformational Impacts: Waste Reduction and Residential Diversion

Using a Zero Waste Framework, the 25-year Waste Strategy aims to transform the waste system by focusing on waste reduction as well as committing to diversion of residential and non-residential waste from landfill.

Manage the Corporation: Stable and Consistent Utility Rates

The Waste Services utility will maintain stable and consistent utility rates, as per the Waste Services Utility Fiscal Policy C558B, through service delivery enhancements, and generating revenue through the sale of waste byproducts, such as compost and renewable natural gas.

Deliver Excellent Services: Supporting Transformation

Newly-created programming, digital support for residents and improved customer journey mapping will provide the customer support required for successful system adaptations and increased waste prevention and diversion. Continued employee safety and revised workforce training programs will enhance physical and mental well-being, as well as future role readiness.

The Waste Services utility continues to be positioned well for the changes related to the continued implementation of the 25-year Waste Strategy. As the utility has matured and rate increases have stabilized, two-year rate filings are proposed for 2023-2024 and 2025-2026, with a transition to a four-year rate filing for the following budget cycle (2027-2030). The 2023-2024 Waste Services Utility Rate Filing, recommends a 0.9 per cent annual rate increase. Stable and consistent utility rates remain a key goal, with a focus on programs and activities that promote waste prevention, waste reduction, reuse of materials, circular economy innovations and alignment to the Zero Waste Framework for all City of Edmonton sectors.

1. INTRODUCTION

The Waste Services utility is an essential part of the City Plan and supports Climate Resilience through innovation and partnerships. The utility's goal is to support and encourage Edmontonians, businesses and institutions in their waste management practices. The Waste Services utility will support Edmontonians by ensuring utility rates remain stable and consistent, and will lead by example focusing on waste reduction and increased waste diversion. These actions will be directed at the minimization of materials going to landfill to enable the utility to move towards the diversion goals set by Council.

Implementation of the 25-year Waste Strategy continued throughout 2022 with key projects being completed and approved, with work on these projects continuing over the business planning cycle.

- In April, Edmonton's Plan to Reduce Single-use Items was approved. The Single-use Items Plan prioritizes the use of reusable items and the elimination of unnecessary single-use items, regardless of the material type.
- Also in April, the Three-stream Communal Collection Business Case was approved. This will see the City phase in mandatory three-stream communal collection, where waste is disposed of in shared containers, with mandatory co-location for disposal of each waste stream to approximately 167,000 residential households at almost 3,400 properties.
- In October, the Single-use Item Reduction Charter Bylaw was unanimously approved by Council. The bylaw addresses the growing number of single-use items in the waste stream and natural environment. The bylaw will come into effect on July 1, 2023 and will require residents, businesses and organizations to make reusable alternatives their default choice. The bylaw precedes federal regulations on plastics.
- 2022 is the first full year of operation for the Edmonton Cart Rollout for over 250,000 residential households that receive curbside collection. Residents sort their waste into four streams including food scraps/organics, yard waste, recycling and garbage.

The Waste Services utility will continue to implement programs from the 25-year Waste Strategy, provide essential service to Edmontonians while maintaining full cost recovery, and improve the employee and resident experience to support adaptation of new systems. Over the next four years, the Waste Services utility plans to deliver the following:

- A residential diversion rate target of 40 per cent in 2023 and 2024.
- Further implementation of the Waste Reduction Roadmap to promote zero per cent growth in per-person residential waste generation.
- Enhancement of the Corporate Three-stream Waste Program and alignment with other corporate utility management best practices.
- A mandatory source separation program for approximately 167,000 residential households receiving communal collection. The Waste Services Bylaw will also be updated in Q1 2023 to reflect this new residential program.
- An Industrial, Commercial and Institutional sector program strategy.
- Service delivery enhancements, focusing on efficiency, effectiveness, resident experience and information technology to deliver stable and consistent utility rates.

Stable and consistent utility rates remain a key goal over the next four years. Service delivery enhancements and the ability to earn revenue from the sale of waste byproducts, such as compost and renewable natural gas, will contribute to achieve this goal. The service delivery enhancements will be achieved through technology deployment and process optimization and will improve operational efficiency. Enhanced employee engagement and a continued safety culture will improve productivity and help retain top talent.

2. ORGANIZATIONAL STRUCTURE

The organizational structure of the Waste Services utility is fully aligned to the Corporate Business Plan and consists of four sections (Figure 1).

Figure 1: Waste Services Utility Organizational Structure

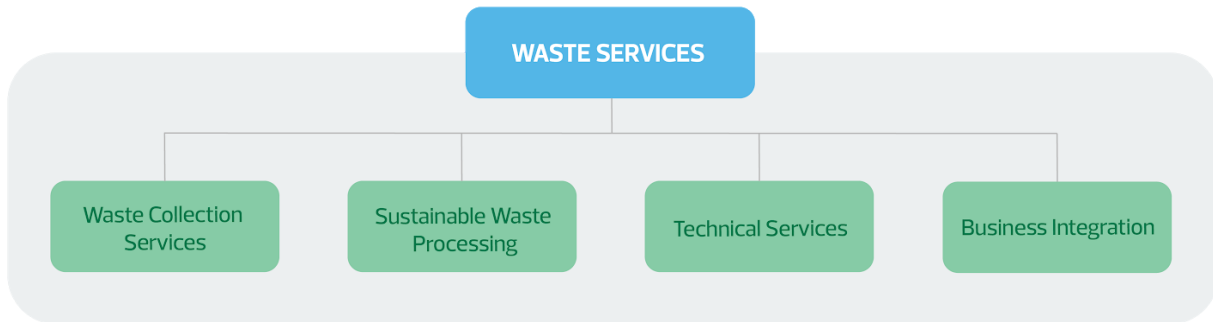

Waste Collection Services

Waste Collection Services provides efficient and effective waste collection to the residential sector including curbside collection for over 250,000 households and communal collection for approximately 167,000 households. This area also manages the Assisted Waste Collection program for residents with mobility restrictions. Residents have access to a number of facilities where various items can be dropped off for recycling or disposal including Eco Stations, Community Recycling Depots and Big Bin Events.

Sustainable Waste Processing

Sustainable Waste Processing receives and sorts residential and non-residential waste at the Edmonton Waste Management Centre, a unique collection of advanced processing and research facilities. This integrated site, located on 233 hectares in northeast Edmonton, is designed to handle more than 500,000 tonnes of waste per year. Facilities and operations are either owned and operated by the City or run on a contract basis with private industry partners. The focus of these facilities is to recover valuable resources and to minimize the amount of waste going to landfill.

Technical Services

Technical Services is dedicated to the engineering, technical support, innovation and environmental compliance of waste processing and collection operations. This area provides oversight for capital projects and large operational investments to ensure the utility's operations are compliant, effective and efficient. This section also manages environmental regulatory compliance and the Clover Bar Landfill post-closure operations.

Business Integration

Business Integration is responsible for the coordinated delivery of the 25-year Waste Strategy, facilitating operational direction, resource allocation, financial governance and alignment to corporate directives. Key areas of focus include performance management, monitoring and reporting, contract management, customer experience, sales and marketing, utility rate filing and billing. This area is also responsible for managing the Reuse Centre, communication, education, outreach and volunteer programs that keep residents engaged in sustainable waste practices and waste reduction efforts. Business Integration leads research, public engagement, business case development, program and service design, project management and change management in coordination with all other sections to guide the transformation of Edmonton's waste system to a Zero Waste Framework.

3. METHODOLOGY & KEY ASSUMPTIONS

The following subsections provide the methodology and key assumptions for the 2023-2024 Waste Services Utility Rate Filing. The Rate Filing is based on the August 31, 2022 financial forecast incorporating significant changes up to September 30, 2022. The assumptions used to develop the Rate Filing include City Council approved corporate budget guidelines and forecasts from the City's Corporate Economist.

- **Forecast Housing Starts and Consumer Price Index**

	2023	2024	2025	2026
Housing Starts	9,598	9,111	8,948	8,973
Consumer Price Index	3.30%	1.90%	2.10%	2.10%

- The following table provides a further breakdown of expected customer growth projections between curbside and communal customers based on historical averages. On October 1, 2021 all existing curbside customers transitioned to a cart-based collection system. Customer growth projections assume that the cart size distribution profile for new customers follows a similar trend to that experienced in 2022.

Housing Starts	2023	2024	2025	2026
120L Cart	554	492	483	484
240L Cart	5,269	4,678	4,594	4,608
360L Cart*	26	23	23	23
Communal	3,749	3,918	3,848	3,858
Total	9,598	9,111	8,948	8,973

*Available only to residents that meet unique requirements to qualify.

- **Employee Benefits**

The 2023-2026 Operating Budget amounts were calculated by the City of Edmonton's Capital and Operating Budget System (COBS) which allocates benefit dollars by employee. The Rate Filing includes an update for any recent changes in benefit rates for the Local Authorities Pension Plan, Canada Pension Plan, Employment Insurance, Major Medical and Dental Plan, Group Life Insurance and Health Care Spending Account.

- **Regulatory Methodology**

The revenue requirement and customer rates are based on the forecast costs required by the utility to provide its services using a cost of service methodology. The methodology and allocations used in determining the revenue requirement are based on the 2017 Cost of

Service Study completed by an independent consultant in 2018. An updated Cost of Service Study will be done in 2023 using a full year of operational and financial data from 2022 to ensure that cost allocations appropriately reflect the impacts of service delivery changes provided by the utility to its customers.

- **Cost of Debt**

Debt servicing calculations use the cost of debt rate forecast provided by the City's Corporate Accounting and Reporting section and are based on actual Government of Alberta (formerly the Alberta Capital Financing Authority) borrowing rates as of the second quarter of 2022. The rates are calculated to be mid-year estimates. An additional 0.25 per cent increment is added per year starting in 2023 with rates capped at 6.00%.

Term	2023	2024	2025	2026
10 year	4.94%	5.19%	5.44%	5.69%
15 year	5.13%	5.38%	5.63%	5.88%
20 year	5.24%	5.49%	5.74%	5.99%
25 year	5.33%	5.58%	5.83%	6.00%

Other assumptions include the following:

- Waste Services Utility Staff Vacancy - Unless otherwise stated, the typical expected staff vacancy is four per cent for all staff.
- Full-time Equivalent - A full-time equivalent (FTE) is defined as the hours (and associated personnel costs) one full time employee would work in a year. For example, if a position is funded for one year, it is equivalent to 1.0 FTE, whereas a position funded for six months is equivalent to 0.5 of an FTE. Funding for a new position may be adjusted in the first year to reflect the timing between approval of a new position and hiring, with full funding for the position beginning the following year.
- Customer Growth - The customer counts are based on historical trends and the anticipated household starts as projected by the City's Corporate Economist.
- Multi-unit Sector - The 2023-2034 Rate Filing assumes services to residential customers in this sector are provided under a fully regulated status-quo model as approved by Council in April 2022. The rate forecast incorporates capital and operating requirements starting in 2023 to support the implementation of three-stream waste separation in the multi-unit sector.

- Cart Adoption - During 2021, over 250,000 households moved to four-stream collection as part of the Edmonton Cart Rollout with separate food scraps collection, seasonal yard waste collection, blue bag recycling and garbage volume limits. After the citywide distribution of carts, curbside customers were transitioned to variable rates on October 1, 2021 based on their choice of garbage cart size. Rate revenue forecasts have been updated to include the current cart distribution as of August 31, 2022. Expected curbside customer growth was forecasted to align with the actual cart adoption. The customer base assumed in the Rate Filing to recover revenue requirement from the residential curbside and communal customers is represented in the figures below:

Service Type	2021 Actual	2022 Projected	2023 Proposed	2024 Proposed	2025 Forecast	2026 Forecast
120L Cart	23,542	22,311	22,611	22,877	23,711	25,051
240L Cart	211,185	212,322	215,176	217,710	225,645	238,392
360L Cart*	1,577	1,055	1,069	1,082	1,121	1,185
Transition - Cohort 1	6,899	7,233	7,233	7,233	-	-
Transition - Cohort 2	12,035	12,572	12,572	12,572	12,572	-
Curbside	255,238	255,493	258,661	261,474	263,049	264,628
Communal	163,312	164,038	168,705	173,463	175,547	177,637
Total	418,550	419,531	427,366	434,937	438,596	442,265

*Available only to residents that meet unique requirements to qualify.

A review of customer accounts was completed as part of the 2017 Cost of Service Study. Through this review a number of households were identified as receiving service as if they were a curbside customer but were being charged the lower communal rate. In 2019, the Waste Services Bylaw was updated to allow for customers to be charged in alignment with their service type. The utility undertook a project to review these accounts to determine the appropriate classification and service type. These households were reclassified from the communal rate to the curbside rate. To avoid rate shock for these customers, the utility received approval to adjust the rates over a five-year period. These customers are classified as Transition - Cohort 1 (customers who began the transition period in 2020) and Transition - Cohort 2 (customers who began the transition period in 2021) as noted in the table above.

- Curbside and Communal Customer Counts - The following two tables compare the budget customer counts to the actual/projected customer counts for curbside and communal customers. The tables illustrate the historical customer growth as well as the improvement in forecasting accuracy.

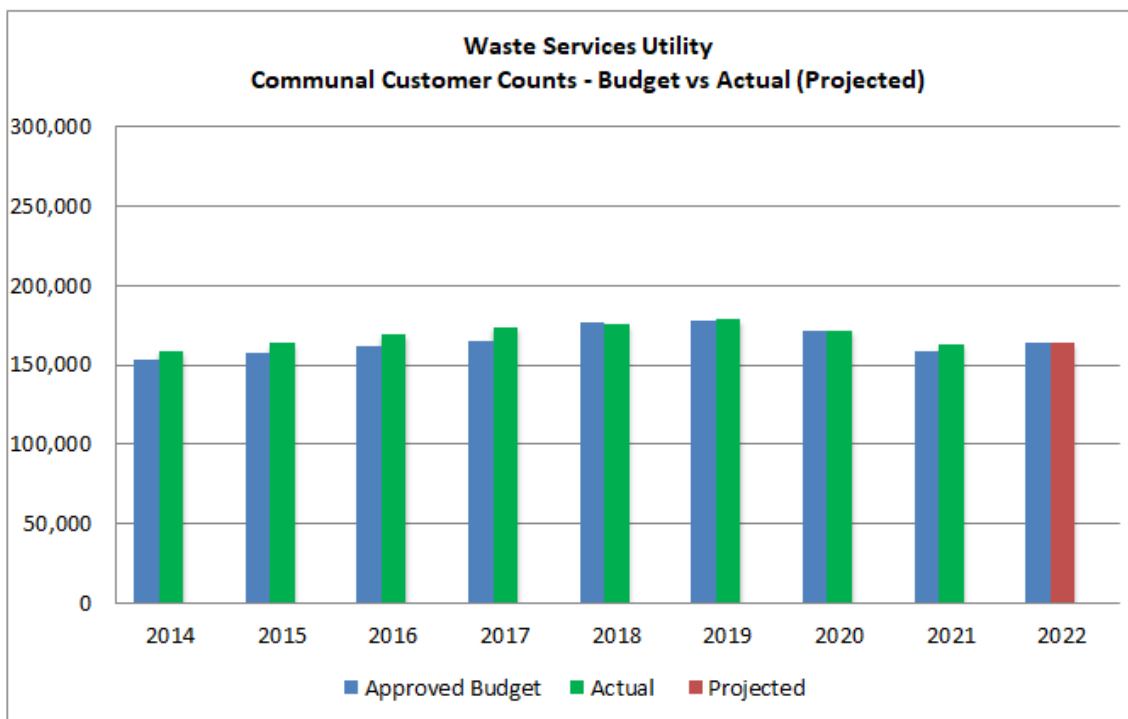
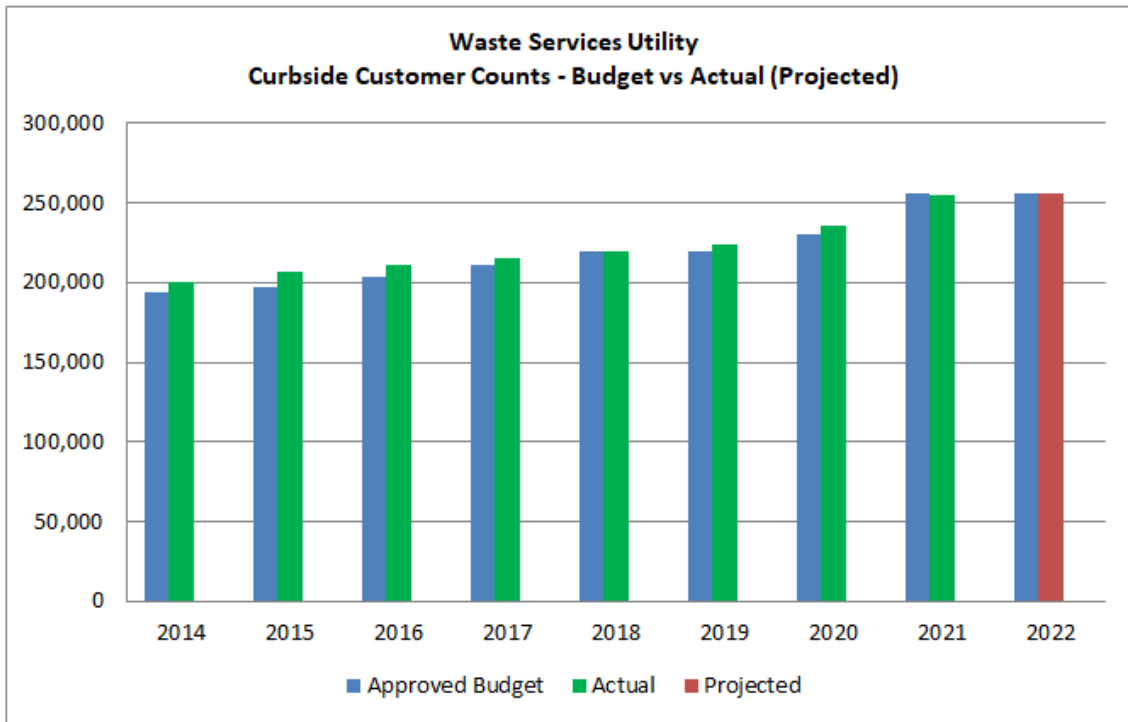

Carbon Budget

To support Edmonton's transition to a low carbon future, the City's 2023-2026 budget will be the first time a carbon budget is completed and delivered to Council in conjunction with the operating, capital and utility budgets. Use of the Carbon Budgeting and Accounting Framework will guide the organization and Council in understanding how financial investment decisions impact the achievement of emissions reductions targets or eliminate Edmonton's carbon deficit.

All budget requests have been assessed for both qualitative carbon impacts and more detailed quantitative carbon impacts where possible. The qualitative assessment links direct emissions impacts to the four pathways in the Energy Transition Strategy and indicates indirect emissions impacts.

Carbon impacts have been presented for each capital project and operating service package under consideration in the City's 2023-2026 budget in the standalone 2023-2026 Carbon Budget. The 2023-2026 Carbon Budget is scheduled to be released on November 14, 2022.

Extended Producer Responsibility

Extended Producer Responsibility is an environmental policy approach under which producers have financial and/or physical responsibility for their products, through to the post-consumer stage of the product life cycle. Extended Producer Responsibility shifts operational responsibility and the cost of managing product waste from municipalities and ratepayers to producers: manufacturers, brand owners and retailers.

On October 3, 2022, the Government of Alberta released an Extended Producer Responsibility regulation and is planning to implement this over the next few years. This will be a major shift in accountability and responsibility from the Waste Services utility to Producers for the Blue Bag program and the Hazardous and Special Products program. Producers are required to finalize a plan for servicing the entire province by April 2024, and implementation of the plan will begin in April 2025.

The City continues to work closely with the Government of Alberta and its municipal partners to ensure alignment of this initiative and preparedness for implementation. Future rate filings may be impacted by the implementation of Extended Producer Responsibility.

4. OPERATIONAL PERFORMANCE

Key Performance Metrics

The four performance goals below summarize the utility's performance measures.

GOAL	PERFORMANCE MEASURE	ACTUAL	TARGETS				
		2021 Actual	2022 Projected	2023 Proposed	2024 Proposed	2025 Forecast	2026 Forecast
Customer Excellence	Curbside Organics & Recyclables Collected	34%	55%	56%	58%	59%	60%
	Kg/Capita Residential Waste Generated	333	No increase from 2021 (363 kg)	No increase from 2022 (363 kg)	No increase from 2023 (363 kg)	No increase from 2024 (363 kg)	No increase from 2025 (363 kg)
Operational Excellence	Residential Diversion Rate ¹	27%	40%	40%	40%	40%	40%
	Number of Reportable Environmental Incidents	5	<20	<20	<20	<20	<20
Financial Accountability	Annual Net Income (\$M)	\$20.89	\$5.91	\$5.56	\$4.65	\$1.72	\$1.61
	Stable Rates	0.0%	0.0%	0.9%	0.9%	0.9%	0.9%
	Debt Service Coverage Ratio	12.2%	12.8%	12.7%	13.1%	13.5%	13.6%
	Cash Position ² (\$M)	\$83.48	\$76.46	\$45.45	\$40.87	\$28.40	\$32.76
Organizational Excellence	Employee Satisfaction Rate (Glint Survey) ³	67	68	69	70	70	70
	Number of Near Miss Incidents	232	10% more than the previous year	10% more than the previous year	10% more than the previous year	10% more than the previous year	10% more than the previous year
	Lost Time Frequency Rate (Trailing 12 Months)	2.03	3.04	2.73	2.46	2.21	2.21

¹ With the approval of the Three-stream Communal Collection Business Case, diversion rate reporting and targeting will now include both curbside and communal collection. The Residential Diversion Rate is a blended single unit and multi-unit residential diversion rate. For reference purposes, the 2021 single unit diversion rate was 34% and the multi-unit diversion rate was 10% for a combined diversion rate of 27%.

² The cash position of the utility includes cash held to fulfill obligations for the Clover Bar Landfill and Bremner Lagoon liabilities.

³ Target has been reduced from 73 to 70 reflecting current trending.

5. FINANCIAL RATE IMPACTS

The financial rate impacts below represent the incremental change to the utility rate from the previous year. The resulting rate impacts reflect the services and processes required to support the Waste Services utility's mission, values and strategic initiatives. The rate impacts have been grouped into three categories: Operating Impacts, Capital Impacts on Operating and Other Impacts.

	2021 Approved	2022 Approved	2023 Proposed	2024 Proposed	2025 Forecast	2026 Forecast
Operating Impacts	\$ 0.52	\$ 0.09	\$ 3.24	\$ 1.06	\$ 0.90	\$ 0.79
Capital Impacts on Operating	0.72	(0.63)	0.30	0.73	0.62	0.21
Other Impacts						
Non-rate revenue	0.45	0.16	(0.28)	(0.18)	0.05	(0.13)
Increase Customer Base	(0.64)	(0.85)	(0.86)	(0.83)	(0.58)	(0.59)
Rate of Return	(1.05)	1.23	(1.97)	(0.34)	(0.55)	0.17
SUBTOTAL	(1.24)	0.54	(3.11)	(1.35)	(1.08)	(0.55)
TOTAL RATE IMPACTS	\$ -	\$ -	\$ 0.43	\$ 0.44	\$ 0.44	\$ 0.45

Operating Impacts

The increase in Operating Impacts from the 2022 budget includes additional costs related to customer growth and higher inflation, additional costs associated with the increased cost for Collection contracts and for the Communal Collection Program.

With the approval of the Three-stream Communal Collection Business Case in April 2022, the City will be phasing in mandatory three-stream collection for approximately 167,000 residential households that receive communal collection at almost 3,400 properties. The program is scheduled to start in fall 2023 and continue for the next several years.

Capital Impacts

The increase in the capital impact for 2023, relative to the 2022 budget, is mainly driven by higher interest rates forecasted for borrowing and increases in capitalizations related to Fleet Asset purchases and the Materials Recovery Facility Renewal. Fleet Assets are also funded by Pay-As-You-Go (PAYG) which requires the utility to raise cash the year in advance of the projected purchases.

Other Impacts

- The non-rate revenue impact is the result of increases from other program revenue which includes revenues generated from third parties operating at the Edmonton Waste Management Centre based on agreements, such as sharing of third-party sales revenues. Also included in this category are revenues generated from environmental initiatives such as the sale of renewable natural gas.
- Based on current economic conditions and housing starts, the customer base is forecast to grow in 2023 through to 2026. This growth allows regulated revenue to be allocated over a larger base therefore controlling the per unit Residential Customer Rate increase. The greater number of residential customers will generate higher regulated revenue which will be used to offset the associated residential waste operational costs. Regulated revenue determination for curbside customers has changed from a monthly unit rate to variable cart rates based on the size of a customer's garbage cart with the implementation of the Edmonton Cart Rollout.
- Approval of the Waste Services Utility Fiscal Policy C558B in December 2020 resulted in changes to the rate revenue calculation. A requirement for PAYG funding is now included as part of the rate revenue calculation to ensure sufficient cash is generated to meet the utility's current and future capital needs. The Rate of Return is calculated to achieve a Net Income position to meet cash and/or PAYG targets. This places greater emphasis on long-term planning and the continued financial sustainability of the utility.

6.1 Utility Rates

On October 1, 2021, curbside customers transitioned to variable utility rates based on their choice of garbage cart size following the implementation of cart-based collection to all curbside residential customers. The following table outlines the proposed cart rates for 2023 and 2024 (and forecasts for 2025 and 2026) and the estimated adoption of garbage carts by curbside customers.

2023 to 2026 Curbside Monthly Utility Rates

Garbage Cart Size (in litres)	2023 Proposed	2024 Proposed	2025 Forecast	2026 Forecast	Customer Adoption
120L	\$43.75	\$44.19	\$44.63	\$45.08	9.47%
240L	\$48.75	\$49.19	\$49.63	\$50.08	90.08%
360L*	\$58.75	\$59.19	\$59.63	\$60.08	0.45%

*Available only to residents that meet unique requirements to qualify.

Variable rates provide a financial incentive for customers who embrace waste reduction and waste sorting behaviours that reduce the amount of garbage they generate to help achieve the City's waste diversion targets. For 2023 and 2024, the difference between the 120-litre rate and the 240-litre rate will be \$5 per month and the difference between the 240-litre rate and the 360-litre rate will be \$10 per month. The 360-litre cart is only available to households that meet specific criteria including large households and those generating non-hazardous home health care waste. The differential pricing allows customers to determine the amount of service they require, along with the financial flexibility associated with the variable rates. The rate for curbside collection is increasing by \$0.43 in 2023 and \$0.44 in 2024.

Most customers in multi-unit households, such as apartments and condominiums, receive communal collection, where waste is disposed of in shared containers. The rate for communal collection is increasing by \$0.28 in both 2023 and 2024.

The rate for customers who began transitioning from communal collection to curbside collection in 2020 will increase by \$3.93 in 2023 and \$3.99 in 2024. The rate for customers who began transitioning from communal collection to curbside collection in 2021 will increase by \$3.90 in 2023 and \$3.96 in 2024.

6.2 General Comments for Financial Indicators

Target: Rates Sufficient to Meet Expenditures

The proposed and forecasted years all meet the requirement of generating sufficient net income to cover operating expenses.

Target: Cash Position

The target cash position for the Waste Services utility includes capital funding to meet Pay-As-You-Go (PAYG) requirements for the future fiscal years plus a risk allowance to mitigate exposure, such as volatility of the markets for recyclable commodities, as outlined in the Waste Services Utility Fiscal Policy C558B. The PAYG requirement is expected to remain high at \$16.5 million in 2023 as higher vehicle purchases are expected in 2024 due to asset lifecycle replacement requirements after supply chain shortages due to COVID-19 and the crisis in Ukraine. The calculation of the risk exposure includes the following identified risks (in millions of dollars):

	2021 Approved	2022 Approved	2023 Proposed	2024 Proposed	2025 Forecast	2026 Forecast
Recyclable Market	\$ 0.48	\$ 0.48	\$ 0.48	\$ 0.48	\$ 0.48	\$ 0.48
Landfill gas, 3rd party	0.50	0.50	0.30	0.30	0.30	0.30
REVENUE RISKS	0.98	0.98	0.78	0.78	0.78	0.78
Anaerobic Digestion Facility	0.48	-	-	-	-	-
Operational Impacts Agreements/Strategic Changes	2.10	2.66	0.96	0.94	1.01	0.94
EXPENDITURE RISKS	2.58	2.66	0.96	0.94	1.01	0.94
TOTAL RISK ALLOWANCE	\$ 3.56	\$ 3.64	\$ 1.74	\$ 1.72	\$ 1.79	\$ 1.72

The allowance for Operational Impacts and Agreements/Strategic Changes include provision for operational risks and implementation of the Communal Collection Program. The expected risk has gone down from 2022 and will remain consistent. Over time as the utility incorporates changes to its operations based on learnings and experiences from the Source Separated Organics program this should decrease. After accounting for the PAYG requirements and risk allowance, the cash balance is positive in all years due to the significant cash reserves held for both the Landfill Post Closure Liability and the Bremner Lagoon Liability.

Target: Stable and Consistent Utility Rates

The Waste Services utility places a high priority on financial sustainability, and achieving stable and consistent utility rates remains a key goal. As defined in the Waste Services Utility Fiscal Policy C558B, utility rates are considered to be stable and consistent when the year-over-year change in rates is within $\pm 2\%$ of the Consumer Price Index for the Edmonton metropolitan region. For 2023 and 2024, the target will be achieved with a 0.9 per cent rate increase across all residential customer classes (with the exception of multi-unit transition customers). To achieve this target, the utility will focus on service delivery enhancements, opportunities to generate additional revenue through the sale of waste byproducts, enhanced asset optimization and operational efficiencies. In addition, the utility will use existing cash to reduce future borrowings and to smooth the impacts of current and expected inflation.

Target: Debt Service Coverage Ratio

Debt service coverage measures the ability of the utility to meet its debt servicing obligations using annual revenues. The debt service coverage indicator is achieved when the utility's Debt Service Coverage Ratio is not greater than 22 per cent as outlined in Waste Services Utility Fiscal Policy C558B⁴. Based on the anticipated capital financing requirements for the utility, the debt service ratio is expected to remain well below 22 per cent.

⁴ A new City of Edmonton Debt Management Fiscal Policy (C203D) has been developed and will be presented to Council in Q1 2023. The Waste Services Utility Fiscal Policy C558B will be reviewed at that time to ensure alignment to the new City policy.

7. UTILITY SUMMARY SCHEDULE

(in millions of dollars)

Line #	Reference	2021 Actual	2022 Budget	2022 Projected	2023 Proposed	2024 Proposed	2025 Forecast	2026 Forecast	
1	Operations and Maintenance	Sch. 8.0	\$ 166.72	\$ 176.35	\$ 183.55	\$ 189.04	\$ 193.38	\$ 197.40	\$ 200.90
2	Amortization of Non-Contributed Assets	Sch. 9.0	23.24	24.68	24.37	25.81	28.47	30.79	32.31
3	Debt Interest	Sch. 9.0	8.24	8.23	8.29	8.21	8.53	8.76	8.77
4	Intra-municipal Recoveries	Sch. 8.8	(1.10)	(6.99)	(6.99)	(3.54)	(3.41)	(3.40)	(3.48)
5	Amortization of Regulatory Asset	Sch. 8.0	3.91	3.91	3.91	3.91	3.91	3.91	3.25
	TOTAL EXPENSES		201.01	206.18	213.12	223.43	230.88	237.46	241.75
6	Non-Rate Revenue	Sch. 10.1	22.75	13.02	13.02	16.58	17.28	17.19	17.90
7	Rate Revenue	Sch. 10.0	199.15	205.95	206.01	212.41	218.24	221.99	225.47
	TOTAL REVENUES		221.90	218.97	219.03	228.99	235.52	239.18	243.36
	NET INCOME/(LOSS)	Sch. 13.0	\$ 20.89	\$ 12.79	\$ 5.91	\$ 5.56	\$ 4.65	\$ 1.72	\$ 1.61

Line 1 - Operations and Maintenance

The increase in operations and maintenance from the 2022 Projection primarily reflects the implementation of the Communal Collection Program with cost increases to personnel and external service costs. Other increases include higher costs on Collection Service contracts, higher than average inflation in 2023, higher natural gas prices for utilities, anticipated cost increases due to customer growth and higher fleet costs related to increased fuel prices.

Line 2 - Amortization of Non-Contributed Assets

Increases in amortization result from the commissioning of assets into service related to the Materials Recovery Facility renewal, Three-stream Communal Collection, site infrastructure and facilities projects, and mobile equipment and waste container purchases.

Line 4 - Intra-municipal Recoveries

The decrease in intra-municipal recoveries from the 2022 Projection primarily reflects the removal of the Commercial Collection program. Commercial Collection has been added to Non-rate Revenue and reflected on table 10.1. Other decreases include reduced internal aggregate sales. For additional details, refer to schedule 8.8 Intra-Municipal Recoveries.

Line 5 - Amortization of Regulatory Asset

A deferral account was approved in the 2019 Rate Filing to allow the utility to recover the expenses incurred for the Edmonton Composting Facility through customer rates over a reasonable time period to minimize the rate impact and to maintain stable and consistent rates.

Amortization of the regulatory asset represents the annual amount of the deferral account balance recovered through utility rates in a given period. There are no additions to the previously approved deferral account balances in the 2023-2024 Rate Filing. Refer to schedule 9.1 for additional details.

Line 6 - Non-Rate Revenue

Increase in non-rate revenue is related to the addition of Commercial Collection revenue which was reflected as an interdepartmental Recovery in 2022. The reduction in the Commercial Collection interdepartmental recovery is reflected on table 8.8. Other increases to Non-rate Revenue include higher Investment Earnings and Materials Recovery Facility revenue. See schedule 10.1 for additional details.

Line 7 - Rate Revenue

Increase in rate revenue is primarily driven by Pay-As-You-Go requirements to support capital, additional requirements to fund landfill liability, additional requirements to support growth in the customer base, and increased collection, processing and diversion of waste from landfill.

Further detailed analysis of proposed expenditures and revenues are provided in subsequent schedules.

8. OPERATIONS & MAINTENANCE

(in millions of dollars)

Line #	Reference	2021 Actual	2022 Budget	2022 Projected	2023 Proposed	2024 Proposed	2025 Forecast	2026 Forecast	
1	Personnel	Sch. 8.1	\$ 48.38	\$ 51.06	\$ 51.06	\$ 55.61	\$ 57.75	\$ 58.82	\$ 59.94
2	Materials, Goods & Supplies	Sch. 8.2	3.47	3.79	3.79	2.98	3.00	3.02	3.07
3	External Services	Sch. 8.3	74.25	81.14	81.14	87.23	89.52	92.12	94.13
4	Fleet Services	Sch. 8.4	13.96	15.73	15.73	16.17	15.68	15.68	15.65
5	Shared Services	Sch. 8.5	9.72	10.08	10.08	10.42	10.52	10.62	10.73
6	Intra-municipal Services	Sch. 8.6	4.54	5.74	5.74	6.42	6.48	6.48	6.52
7	Utilities	Sch. 8.7	3.61	5.18	5.18	6.38	6.59	6.79	6.93
8	Other Expenses		8.79	3.63	10.83	3.80	3.84	3.89	3.93
	TOTAL O&M EXPENSES		166.72	176.35	183.55	189.02	193.38	197.40	200.90
9	Intra-municipal Recoveries	Sch. 8.8	(1.10)	(6.99)	(6.99)	(3.54)	(3.41)	(3.40)	(3.48)
	RECOVERIES		(1.10)	(6.99)	(6.99)	(3.54)	(3.41)	(3.40)	(3.48)
10	Amortization of Non-Contributed Assets	Sch. 9.0	23.24	24.68	24.37	25.81	28.47	30.79	32.31
11	Amortization of Regulatory Asset	Sch. 9.1	3.91	3.91	3.91	3.91	3.91	3.91	3.25
12	Debt Interest	Sch. 9.0	8.24	8.23	8.29	8.21	8.53	8.76	8.77
	EXPENSES BEFORE ONE-TIMES		201.01	206.18	213.12	223.40	230.88	237.46	241.75
13	Grants		-	-	-	0.02	-	-	-
	NET EXPENSES		\$ 201.01	\$ 206.18	\$ 213.12	\$ 223.43	\$ 230.88	\$ 237.46	\$ 241.75

Line 8 - Other Expenses

Other expenses primarily include insurance premiums associated with waste collection and processing facilities at the Edmonton Waste Management Centre and Eco Stations, bad debt expense and service charges for credit/debit card processing at the Edmonton Waste Management Centre scalehouse and Eco Stations. The 2022 Projection includes a one-time non-cash adjustment to increase the post-closure liability. For further information on the post-closure liability refer to Section 12 - Landfill Closure & Related Liabilities.

8.1 PERSONNEL

(in millions of dollars)

Line #	2021 Actual	2022 Budget	2022 Projected	2023 Proposed	2024 Proposed	2025 Forecast	2026 Forecast
1 Wages	\$ 39.42	\$ 40.67	\$ 40.67	\$ 44.28	\$ 46.22	\$ 47.06	\$ 47.95
2 Overtime	1.23	1.45	1.45	1.62	1.64	1.68	1.72
3 Allowances and Benefits	7.73	8.94	8.94	9.71	9.89	10.08	10.27
TOTAL PERSONNEL	\$ 48.38	\$ 51.06	\$ 51.06	\$ 55.61	\$ 57.75	\$ 58.82	\$ 59.94

Personnel costs include Wages, Overtime, Employment Allowances and Benefits. The City of Edmonton's Capital and Operating Budget System (COBS) utilizes the City's payroll system as the source for the personnel budget for both wages and benefits, thereby providing a reliable and consistent source of information. Vacant positions are set at mid-range with family benefits. Included in the 2023 and 2024 proposed budget is an assumption of a vacancy discount of four per cent for all positions.

Line 1 - Wages

Wages are expected to increase over the 2022 Projection with the addition of 49.0 FTEs to support implementation of the Communal Collection Program, the transfer of a portion of collection services to the City of Edmonton from contractor service, increased customer outreach and support, and increased operational analytics. For more information on the FTE increases see the FTE Justifications in Appendix A.

Line 2 - Overtime

Overtime is expected to increase over the 2022 Projection primarily for Christmas Tree Collection and call volume increases in the Waste Services Customer Support Centre.

Line 3 - Allowances and Benefits

Benefits mainly consist of Local Authorities Pension Plan (LAPP), Canada Pension Plan, Employment Insurance, Major Medical and Dental Plan, Group Life Insurance and Health Care Spending Account.

8.2 MATERIALS, GOODS & SUPPLIES

(in millions of dollars)

Line #	2021 Actual	2022 Budget	2022 Projected	2023 Proposed	2024 Proposed	2025 Forecast	2026 Forecast
1 Collection Services	\$ 1.00	\$ 1.40	\$ 0.95	\$ 1.02	\$ 1.04	\$ 1.07	\$ 1.09
2 Organics	0.21	0.21	0.04	0.04	0.04	0.04	0.04
3 Integrated Processing & Transfer Operations	0.04	0.13	0.13	0.14	0.14	0.14	0.14
4 Haul and Landfill Operations	0.02	0.07	0.07	0.07	0.07	0.07	0.08
5 Other	2.20	1.98	2.60	1.71	1.71	1.70	1.72
TOTAL MATERIALS, GOODS & SUPPLIES	\$ 3.47	\$ 3.79	\$ 3.79	\$ 2.98	\$ 3.00	\$ 3.02	\$ 3.07

Line 1 - Collection Services

The increase in Collection Services from the 2022 Projection is primarily related to an increase in cart maintenance costs related to the Edmonton Cart Rollout.

Line 5 - Other

The decrease in Other from the 2022 Projection is primarily related to a decrease in hired equipment costs for various sections as equipment needs are being met internally.

8.3 EXTERNAL SERVICES

(in millions of dollars)

Line #		2021 Actual	2022 Budget	2022 Projected	2023 Proposed	2024 Proposed	2025 Forecast	2026 Forecast
1	Waste Collection Services	\$ 25.82	\$ 28.30	\$ 27.30	\$ 32.06	\$ 31.80	\$ 32.47	\$ 33.15
2	Materials Recovery Facility	9.05	8.95	7.00	7.75	8.47	8.66	8.85
3	Organics	6.25	11.79	11.79	10.89	11.17	11.60	11.84
4	Integrated Processing & Transfer Operations	7.73	8.10	8.10	11.49	13.05	13.58	13.86
5	Haul and Landfill Operations	12.20	14.62	12.02	11.37	11.08	11.58	11.83
6	Customer Billing Services	5.04	5.01	5.01	4.87	5.21	5.26	5.26
7	Other	8.16	4.37	9.92	8.80	8.74	8.98	9.33
	TOTAL EXTERNAL SERVICES	\$ 74.25	\$ 81.14	\$ 81.14	\$ 87.23	\$ 89.52	\$ 92.12	\$ 94.13

Line 1 - Waste Collection Services

Collection Services' external contracts include curbside collection of residential garbage, recycling, organics and seasonal yard waste. It also includes communal collection of residential garbage and recycling as well as costs for contracted equipment, services at the Eco Stations and other Collection Services programs. Contract work is anticipated to increase due to population growth resulting in increased waste volumes. Current contracts are adjusted annually using a cost index that includes CPI, fuel and labour to better reflect annual changes in direct operating costs. Other increases over the 2022 Projection include additional bin maintenance costs related to the Edmonton Cart Rollout and costs related to the Communal Collection Program.

Line 2 - Materials Recovery Facility

The Materials Recovery Facility sorts and processes recyclables collected through the blue bag and recycling depot programs. In 2022 the facility was shut down for planned upgrades. It is scheduled to resume processing waste in Q2 2023. An increase from the 2022 Projection is the result of higher contract fees and an increase in incoming recyclable volumes.

Line 3 - Organics

Contracted organics costs include operations and maintenance for the Anaerobic Digestion Facility allowing for approximately 40,000 tonnes per year of organic material to be processed and diverted from landfill. In addition, the projected cost in 2023 and 2024 includes the cost for processing organics under a number of distributed off-site processing contracts with the private

sector, allowing for an additional 42,000 tonnes per year to be processed and diverted from landfill for the next five years.

Line 4 - Integrated Processing and Transfer Facility (IPTF)

Feedstock for waste-to-energy applications is prepared at the Refuse Derived Fuel Facility, located within the Integrated Processing and Transfer Facility (IPTF). The utility pays contractually agreed upon fees to third-party processing facilities for the conversion of feedstock into energy. The fees include a tipping fee for the delivery of acceptable feedstock to the facilities. In 2022 the third-party facilities required less feedstock from the Refuse Derived Fuel facility than forecasted. It is anticipated that more feedstock will be required in 2023 and 2024 resulting in higher contract costs. In addition the IPTF will see additional operating and maintenance costs in 2023.

Line 5 - Haul and Landfill Operations

Hauling and Landfill Operations represents the contract fees for all of Waste Services utility operations. The decrease from the 2022 Projection is related to decreased tonnage going to landfill in 2023 and 2024.

Line 6 - Customer Billing Services

The utility has a contract with EPCOR for the provision of customer billing and collection services. A new contract took effect in 2021. The change from the 2022 Projection is for the updated contractual rates. The Waste Services utility works closely with EPCOR to ensure good value from this contract for residential customers.

Line 7 - Other

Other Contracted Costs include the Communal Collection Program, Waste Characterization Study, Household Hazardous Waste Disposal and implementation of the digital strategy. Other contract costs also include Community Relations and Program Management, Engineering Analysis, Administrative Services, and other facilities such as Edmonton Waste Management Centre Operations, Advanced Energy Research Facility, Marketing Compost Facility, Research & Development and Environmental. The reduction in costs from 2022 to 2023 are mainly due to insourcing a portion of the Communal Collection Program to approach a 50/50 split of work between internal City of Edmonton staff and external contractors.

8.4 FLEET SERVICES

(in millions of dollars)

Line #	2021 Actual	2022 Budget	2022 Projected	2023 Proposed	2024 Proposed	2025 Forecast	2026 Forecast
1 Fleet Reserve Contribution	-	\$ 0.07	\$ 0.07	-	-	-	-
2 Fuel	3.48	4.31	4.31	4.83	4.34	4.34	4.31
3 Direct Charge & Repairs	10.48	11.35	11.35	11.34	11.34	11.34	11.34
TOTAL FLEET SERVICES	\$ 13.96	\$ 15.73	\$ 15.73	\$ 16.17	\$ 15.68	\$ 15.68	\$ 15.65

Fleet Services are managed by the City of Edmonton on behalf of the Waste Services utility. As the client, the utility bases its maintenance and procurement decisions on data and information from Fleet Services. The City manages the procurement of vehicles and equipment based on communicated requirements from the utility and also handles the fuel contracts.

As Fleet Services recovers 100 per cent of branch costs, a portion of indirect branch overhead is charged to the utility. The indirect overhead is allocated through work order fees, vendor work charges and fuel surcharges. The remaining overhead costs are recovered through shop rates on shop labour hours. Indirect overhead includes administration, training, engineering, procurement, safety, client relations, and facility and equipment maintenance. Estimates for Fuel and Direct Charges & Repairs are estimated by Fleet Services in consultation with the Waste Services utility and aligned with Fleet Services' four-year operating budget for 2023 to 2026.

Funding for the utility's vehicle and equipment replacements are incorporated into the capital program instead of the Fleet Services Reserve. As older equipment purchased by Fleet Services gets replaced, the remaining reserve contribution will be exhausted. The reserve is expected to be fully consumed in 2022.

The increase in fuel from the 2022 Projection reflects an anticipated sustained increase in fuel prices for 2023 without the benefit of significant gains from the City's fuel hedging activities as experienced in 2022. Fuel prices are expected to decline starting in 2024.

8.5 SHARED SERVICES

(in millions of dollars)

Line #	2021 Actual	2022 Budget	2022 Projected	2023 Proposed	2024 Proposed	2025 Forecast	2026 Forecast
1 Corporate Allocation (Central Management)	\$ 2.00	\$ 2.16	\$ 2.16	\$ 2.07	\$ 2.09	\$ 2.11	\$ 2.13
2 Communications & Public Engagement	0.48	0.48	0.48	1.63	1.64	1.66	1.68
3 Financial Services	1.67	1.87	1.87	1.53	1.54	1.56	1.57
4 Safety	0.18	0.18	0.18	0.33	0.33	0.33	0.34
5 Customer Information Services	0.57	0.57	0.57	-	-	-	-
6 Human Resources	1.07	1.03	1.03	1.11	1.12	1.13	1.14
7 Law	0.29	0.29	0.29	0.34	0.35	0.35	0.35
8 Corporate Procurement and Supply Services	0.59	0.59	0.59	0.50	0.50	0.51	0.51
9 Information Technology	2.07	2.07	2.07	1.46	1.47	1.48	1.51
10 Real Estate & Housing	0.80	0.84	0.84	0.67	0.70	0.70	0.70
11 Service Innovation & Performance	-	-	-	0.78	0.78	0.79	0.80
TOTAL SHARED SERVICES	\$ 9.72	\$ 10.08	\$ 10.08	\$ 10.42	\$ 10.52	\$ 10.62	\$ 10.73

The City of Edmonton employs a Shared Services model whereby support services required for the operations of all City businesses are provided through centralized areas of expertise. This approach takes advantage of efficiencies gained through economies of scale and opportunities to provide more robust systems and services (e.g. technology-related services). The Waste Services Utility Fiscal Policy C558B requires that the utility operate under a full cost approach requiring the utility to pay for its portion of shared services.

In March 2021, a third-party consultant conducted a benchmarking study to validate the reasonableness of shared service costs allocated to the utility. The scope of this study included a review and comparison of cost allocations, methodologies, policies, and procedures to evaluate if the Shared Services costs allocated to the Waste Services utility are on par with comparable municipalities. The six most common service categories provided through central services were selected including: Information Technology, Human Resources, Financial Services, Communications Services, Law (Legal Services) and Procurement. Overall, the study concluded that the shared services costs allocated to the Waste Services utility were reasonable and within an acceptable range.

As part of the City of Edmonton's 2023-26 budget cycle, shared service costs were reviewed and re-evaluated to update cost requirements. The Waste Services utility worked with shared service providers to analyse and develop the shared service budget for the 2023-2024 Rate Filing.

Line 2 - Communication & Public Engagement

The increase in charges from the 2022 Projection is related to an increase in costs at the 311 call centre for higher call volume. The historical average call volume was 44,785 annually. The current call volume is, on average, in excess of 68,000 annually following the implementation of the Edmonton Cart Rollout. Also, the Customer Information Services section was moved under the Communications & Public Engagement department.

Line 5 - Customer Information Services

The decrease in charges from the 2022 Projection is related to the movement of Customer Information Services under Communication & Public Engagement.

Line 9 - Information Technology

The decrease in charges from the 2022 Projection is related to actions to reduce the number of personal computers, laptops and applications used by the utility resulting in a lower shared service cost.

Line 11 - Service Innovation & Performance

Service Innovation & Performance was created to provide data and analytical support, including data management, geographic information systems, information analysis, service design and strategic management, and corporate performance. Shared service costs for the utility will begin in 2023.

8.6 INTRA-MUNICIPAL SERVICES

(in millions of dollars)

Line #	2021 Actual	2022 Budget	2022 Projected	2023 Proposed	2024 Proposed	2025 Forecast	2026 Forecast
1 Communications & Public Engagement	\$ 2.53	\$ 0.81	\$ 0.81	\$ 0.70	\$ 0.70	\$ 0.70	\$ 0.70
2 Human Resources	0.06	0.14	0.14	0.10	0.10	0.10	0.10
3 Law	0.20	0.52	0.52	0.37	0.34	0.34	0.34
4 Corporate Procurement and Supply Services	0.33	0.33	0.33	0.33	0.33	0.33	0.33
5 Transportation Operations	0.10	0.08	0.08	0.07	0.07	0.07	0.07
6 Facilities and Landscape Infrastructure	2.19	1.85	1.85	2.34	2.41	2.38	2.41
7 Other	(0.86)	2.01	2.01	2.51	2.53	2.56	2.57
TOTAL INTRA-MUNICIPAL SERVICES	\$ 4.54	\$ 5.74	\$ 5.74	\$ 6.42	\$ 6.48	\$ 6.48	\$ 6.52

Intra-Municipal Services are charges for on-demand services provided through other City of Edmonton programs which are not incorporated in shared services charges. These are direct charges for services such as dedicated support for communication and engagement initiatives, on demand building repairs and maintenance, posting of vacant positions to job sites and security services for special events.

Line 1 - Communication & Public Engagement

The decrease in direct charges from the 2022 Projection is related to a partial decrease in embedded staff support.

Line 6 - Facilities and Landscape Infrastructure

The increase in direct charges from the 2022 Projection is related to an increase in expected maintenance at waste facilities.

Line 7 - Other

The increase in Other costs from the 2022 Projection is primarily related to an increase in safety and transit costs for bus service to the Edmonton Waste Management Centre.

8.7 UTILITIES

(in millions of dollars)

Line #	2021 Actual	2022 Budget	2022 Projected	2023 Proposed	2024 Proposed	2025 Forecast	2026 Forecast
1 Power	\$ 1.64	\$ 3.13	\$ 3.13	\$ 3.44	\$ 3.56	\$ 3.69	\$ 3.77
2 Natural Gas	1.58	1.52	1.52	2.46	2.54	2.59	2.65
3 Water	0.10	0.15	0.15	0.21	0.21	0.22	0.22
4 Other	0.29	0.38	0.38	0.27	0.28	0.29	0.29
TOTAL UTILITIES	\$ 3.61	\$ 5.18	\$ 5.18	\$ 6.38	\$ 6.59	\$ 6.79	\$ 6.93

Power, natural gas and water estimates are provided by the City's Urban Planning and Economy, Economic and Environmental Sustainability section. Estimates are based on historical consumption and future forecasted rates for current service levels. Service level changes are applied to the estimates to determine the budget numbers for each utility.

The increase from the 2022 Projection is related to expected increases in Power and Natural Gas prices. Usage is expected to remain constant.

8.8 INTRA-MUNICIPAL RECOVERIES

(in millions of dollars)

Line #	2021 Actual	2022 Budget	2022 Projected	2023 Proposed	2024 Proposed	2025 Forecast	2026 Forecast
1 Litter Collection Recovery	(0.85)	\$ (0.85)	\$ (0.85)	\$ (0.85)	\$ (0.85)	\$ (0.85)	\$ (0.85)
2 Landfill Disposal Fees	(0.79)	(1.60)	(0.20)	(0.19)	(0.19)	(0.19)	(0.19)
3 Aggregates	-	(3.38)	(3.38)	(2.48)	(2.35)	(2.33)	(2.38)
4 Commercial Collection	-	-	(1.40)	-	-	-	-
5 Charges to Capital & Other	0.55	(1.16)	(1.16)	(0.02)	(0.02)	(0.03)	(0.06)
TOTAL INTRA-MUNICIPAL RECOVERIES	\$ (1.10)	\$ (6.99)	\$ (6.99)	\$ (3.54)	\$ (3.41)	\$ (3.41)	\$ (3.48)

Intra-Municipal Recoveries are billings to other areas within the City of Edmonton for services provided by the Waste Services utility. These recoveries include direct charges such as litter collection charged to Capital City Clean Up and charges to other City of Edmonton areas for disposal of waste at the Edmonton Waste Management Centre and for the purchase of aggregates.

Line 4 - Commercial Collection

The Waste Services utility wound down the external portion of the Commercial Collection in 2021, leaving only City-owned facilities as a customer. For 2022 the budget was moved to Interdepartmental Recovery to reflect internal recoveries instead of revenue. For 2023 it has been moved back to Non-rate Revenue as invoicing remains with the City's billing provider EPCOR and the Waste Services utility continues to receive revenue. The increase in Commercial Collection revenue is reflected in Schedule 10.1.

Line 3 - Charges to Capital & Other

The change in charges to capital and other from the 2022 Projection is related to a decrease in capital recoveries. As in-house engineers work on capital projects, a portion of their time is capitalized to the projects instead of being charged to operating expenses.

9. AMORTIZATION & INTEREST EXPENSE

(in millions of dollars)

Line #		2021 Actual	2022 Budget	2022 Projected	2023 Proposed	2024 Proposed	2025 Forecast	2026 Forecast
1	Amortization of Non-Contributed Assets	\$ 23.24	\$ 24.68	\$ 24.37	\$ 25.81	\$ 28.47	\$ 30.79	\$ 32.31
2	Amortization of Contributed Assets	1.30	1.29	1.37	1.21	\$ 1.31	\$ 1.42	\$ 1.39
	TOTAL AMORTIZATION OF ASSETS	\$ 24.54	\$ 25.97	\$ 25.74	\$ 27.02	\$ 29.79	\$ 32.21	\$ 33.70
3	Long-Term Interest - Existing Borrowing	\$ 8.24	\$ 7.71	\$ 8.08	\$ 7.30	\$ 6.47	\$ 5.61	\$ 4.73
4	Long-Term Interest - Proposed Borrowing	-	0.52	0.22	0.91	\$ 2.05	\$ 3.15	\$ 4.05
	TOTAL INTEREST EXPENSE	\$ 8.24	\$ 8.23	\$ 8.29	\$ 8.21	\$ 8.53	\$ 8.76	\$ 8.77
	COST OF DEBT							
5	Long-Term Debt Principal Repayment - Existing Borrowing	\$ 18.73	\$ 19.13	\$ 19.67	\$ 20.34	\$ 20.82	\$ 21.28	\$ 21.17
6	Long-Term Debt Principal Repayment - Proposed Borrowing	-	1.08	0.10	0.58	\$ 1.43	\$ 2.29	\$ 3.08
		18.73	20.21	19.77	20.93	\$ 22.25	\$ 23.57	\$ 24.25
7	Short-Term Debt Principal Repayment	7.61	-	-	-	-	-	-
	TOTAL PRINCIPAL REPAYMENTS	\$ 26.34	\$ 20.21	\$ 19.77	\$ 20.93	\$ 22.25	\$ 23.57	\$ 24.25
8	Long-Term Debt Balance - Existing Borrowing	\$ 201.34	\$ 215.73	\$ 215.79	\$ 202.79	\$ 203.30	\$ 203.21	\$ 199.80
9	Long-Term Debt Balance - Proposed Borrowing	34.11	15.80	7.34	21.32	\$ 21.20	\$ 17.76	\$ 12.81
	TOTAL LONG-TERM DEBT BALANCE	\$ 235.45	\$ 231.53	\$ 223.13	\$ 224.13	\$ 224.49	\$ 220.97	\$ 212.61
	MID-YEAR LONG-TERM DEBT BALANCE	\$ 242.82	\$ 233.20	\$ 227.33	\$ 223.63	\$ 224.31	\$ 222.73	\$ 216.79

Amortization expense represents the amount of asset life used during a given operating period. The rate of amortization is dependent upon the asset class, each with a predetermined estimated useful life based upon historical experience. The Waste Services utility's assets are divided into 50 different classes with useful lives varying between three years and extending up to 60 years. Amortization expense is calculated using the straight-line method which incurs a half year of expenses in the first and last year of the asset's life.

Interest expense is incurred from Government of Alberta (formerly the Alberta Capital Financing Authority) debentures related to capital projects, as outlined in Schedule 11.1. Projected rates are provided by the City of Edmonton's Corporate Accounting and Reporting section and are based on recent Government of Alberta rates and economic conditions (see Section 3.0 Methodology & Key Assumptions).

Line 1 - Amortization of Non-Contributed Assets

The annual increases in amortization results from the commissioning of assets into service related to the Materials Recovery Facility renewal, Three-stream Communal Collection, HSADF Digestate Screening & Mixing System, site infrastructure and facilities projects, and vehicle and container purchases. The majority of existing assets will not reach the end of their useful life for several more years.

Line 2 - Amortization of Contributed Assets

Amortization of Contributed Assets represents the amount of benefit from assets which were received or funded by third parties. The amortization from contributed assets decreases the amount of total amortization expense for the Waste Services uUtility. This amortization includes benefits received from:

- the Advanced Energy Research Facility and the Alberta Clean Energy Technology Accelerator, both partially funded by Alberta Innovates,
- a large portion of the Edmonton Waste Management Centre Site 440 construction funded by an external third party, and
- the upcoming commissioning of the Landfill Gas to Renewable Natural Gas processing facility funded in part by Emissions Reduction Alberta.

Line 7 - Short-Term Debt Principal Repayment

To address non-regulated program losses and achieve target cash balances, the Waste Services utility was given authorization to draw on a notional short-term loan from the City of Edmonton from 2015 to 2019. On July 5, 2021, City Council approved full notional loan forgiveness for the non-regulated loan repayment, as outlined in City Operations report CO00582.

9.1 DEFERRAL ACCOUNT BALANCES

(in millions of dollars)

Line #	Recovery Period (Years)	2021	2022	2022	2023	2024	2025	2026
		Actual	Budget	Projected	Proposed	Proposed	Forecast	Forecast
1		\$ 26.67	\$ 26.05	\$ 26.05	\$ 22.15	\$ 18.24	\$ 14.33	\$ 10.43
Opening Deferral Balance (Regulatory Asset)								
Additions (Previously Approved)								
2	12	-	-	-	-	-	-	-
3	8	-	-	-	-	-	-	-
4	8	-	-	-	-	-	-	-
5	5	3.29	-	-	-	-	-	-
6		\$ 3.29	-	-	-	-	-	-
Deferral Additions During the Year								
7		\$ 29.96	\$ 26.05	\$ 26.05	\$ 22.15	\$ 18.24	\$ 14.33	\$ 10.42
Deferral Balance Including Additions								
Amortization of Regulatory Asset								
8	12	1.31	1.31	1.31	1.31	1.31	1.31	1.31
9	8	0.63	0.63	0.63	0.63	0.63	0.63	0.63
10	8	1.31	1.31	1.31	1.31	1.31	1.31	1.31
11	5	0.66	0.66	0.66	0.66	0.66	0.66	-
12		\$ 3.91	\$ 3.91	\$ 3.91	\$ 3.91	\$ 3.91	\$ 3.91	\$ 3.25
Total Amortization of Regulatory Asset								
13		\$ 26.05	\$ 22.15	\$ 22.15	\$ 18.24	\$ 14.33	\$ 10.42	\$ 7.17
Closing Deferral Balance (Regulatory Asset)								

The deferral account is a rate-regulated accounting mechanism which allows the utility to minimize rate volatility for ratepayers, by recovering approved cost from ratepayers over a period of time compared to when the costs are actually incurred. This results in the utility recording a regulatory asset for the deferral account balances, which is amortized over a reasonable time period to allow the utility to recover costs from ratepayers while ensuring rate stability. The deferral account balances are primarily related to asset write-down cost and demolition cost resulting from the structural failure of the Edmonton Composting Facility which was approved to be deferred and recovered from ratepayers in the utility's 2019 Rate Filing. For the 2023-2024 Rate Filing, there are no new additions to the previously approved deferral account balances.

Lines 2 - 5: Deferral Additions

Additions to the deferral balance included impairment of the Edmonton Composting Facility structure, equipment and deconstruction costs, identified over the span of 2017 to 2020. These decisions were based on external structural engineer reports and a review of options for repurposing the equipment which was determined to be cost prohibitive. The last impairment of \$3.3 million was recorded at the end of 2020 related to the equipment and was subsequently approved as additions to the previously approved deferral account balances through the 2021 Rate Filing to minimize impact to ratepayers.

Lines 8 - 11: Amortization of Regulatory Asset

The amortization of the regulatory asset represents the annual amount of the deferral balance recovered through utility rates. The amortization period used for the regulatory asset closely matches the remaining useful life of the original asset, and in the case of decommissioning costs a reasonable time period was selected that minimizes rate impact while balancing inter-generational equity. The utility will monitor its deferral account balances for appropriate additions or adjustments to the amortization periods.

10. REVENUE REQUIREMENT

(in millions of dollars)

Line #	Reference	2021 Actual	2022 Budget	2022 Projected	2023 Propose	2024 Proposed	2025 Forecast	2026 Forecast	
1	O&M Expenses and Grants	Sch 8.0	\$ 166.72	\$ 176.35	\$ 183.55	\$ 189.04	\$ 193.38	\$ 197.40	\$ 200.90
2	Intra-municipal Recoveries	Sch 8.0	(1.10)	(6.99)	(6.99)	(3.54)	(3.41)	(3.40)	(3.48)
	Net Operations and Maintenance Expenses		165.62	169.36	176.56	185.50	189.97	194.00	197.42
3	Amortization of Non-Contributed Assets	Sch 8.0	23.24	24.68	24.37	25.81	28.47	30.79	32.31
4	Amortization of Regulatory Asset	Sch 9.1	3.91	3.91	3.91	3.91	3.91	3.91	3.25
5	Debt Servicing - Total Interest	Sch 8.0	8.24	8.23	8.29	8.21	8.53	8.76	8.77
	Total Net Expense		201.01	206.18	213.12	223.43	230.88	237.46	241.75
6	Return on Rate Base	Sch 10.3	20.89	12.79	5.91	5.56	4.65	1.72	1.61
	Total Revenue Requirement		221.90	218.97	219.03	228.98	235.52	239.18	243.36
7	Less Non-Rate Revenues	Sch 10.1	22.75	13.02	13.02	16.58	17.28	17.18	17.90
	TOTAL RATE REVENUE REQUIRED		\$ 199.15	\$ 205.95	\$ 206.01	\$ 212.41	\$ 218.24	\$ 221.99	\$ 225.47

The Waste Services Utility Fiscal Policy C558B was adopted by City Council on December 9, 2020. As per this policy, "at a minimum, the projected total revenue generated will be equal to the projected expenses for the year. The utility is to generate positive net income and sufficient cash flow to cover current year expenses, working capital requirements, and to facilitate the funding for renewal and replacement of its capital assets." Costs associated with contributed capital, such as amortization, are excluded as these are not eligible to be funded through regulated utility rates.

10.1 NON-RATE REVENUE

(in millions of dollars)

Line #		2021 Actual	2022 Budget	2022 Projected	2023 Proposed	2024 Proposed	2025 Forecast	2026 Forecast
1	Program Revenues - Tip Fees	\$ 3.58	\$ 3.68	\$ 3.68	\$ 3.69	\$ 3.61	\$ 3.65	\$ 3.72
2	Program Revenues - C&D Waste	0.29	0.27	0.27	0.28	0.28	0.29	0.29
3	Program Revenues - Materials Recovery Facility	2.26	1.00	1.00	1.54	1.99	2.00	2.04
4	Program Revenues - Commercial Collection	2.19	-	-	2.19	2.19	2.23	2.28
5	Program Revenues - Eco Stations	3.28	3.84	3.84	3.41	3.45	3.48	3.51
6	Program Revenues - Organics Operation	0.04	-	-	-	-	-	-
7	Program Revenues - Other	2.90	3.92	3.92	3.58	4.23	3.98	4.45
8	Investment Earnings	0.14	0.31	0.31	1.49	1.53	1.56	1.60
9	Grants	8.07	-	-	0.40	-	-	-
	TOTAL NON-RATE REVENUE	\$ 22.75	\$ 13.02	\$ 13.02	\$ 16.58	\$ 17.28	\$ 17.19	\$ 17.90

Line 1 - Tip Fees Revenue

Tip Fee Revenues are generated from private haulers disposing of waste materials at the Edmonton Waste Management Centre.

Line 2 - Construction and Demolition Waste Revenue

Processing of construction and demolition waste, and operation of the Construction and Demolition Facility is provided by a third party based on the strategic direction to exit the Construction and Demolition non-regulated business line. The revenues forecasted for construction and demolition relate to royalties received from the third party operating the facility.

Line 3 - Materials Recovery Facility Revenue

Materials Recovery Facility revenue from the sale of recyclable materials are highly influenced by both the commodities market and the US exchange rate. In 2022 the facility was closed for planned upgrades and is scheduled to open in Q2 2023. Materials Recovery Facility revenues are anticipated to be higher in 2023 and 2024 as a result of an expected increase in incoming recyclable volumes and better sorting of materials.

Line 4 - Commercial Collection Revenue

Waste Services wound down the external portion of the Commercial Collection in 2021, leaving only City-owned facilities as a customer. For 2022 the budget was moved to table 8.8 Intra-Municipal Recoveries to reflect internal recoveries instead of revenue. For 2023 it has been moved back to Non-rate Revenue as invoicing remains with the City's billing provider EPCOR and the Waste Services utility continues to receive revenue. The reduction in Commercial Collection intra-municipal recovery is reflected in Schedule 8.8.

Line 5 - Eco Station Revenue

Eco Station revenue updated to reflect expected volume in 2023 and 2024.

Line 7 - Other Program Revenue

Other Program Revenue includes revenues generated from third parties operating at the Edmonton Waste Management Centre based on agreements, which includes sharing of third party sales revenues. Also included in this category are revenues generated from environmental initiatives such as aggregate crushing. The decrease from the 2022 Projection is related to a reduction in collection revenue offset by an increase in Renewable Natural Gas revenue that begins in 2024 and increases in 2025.

Line 8 - Investment Earnings

Investment earnings include interest payments received on existing cash balances. Interest earned is expected to increase due to higher interest rates in the current economic environment.

Line 9 - Grants

The forecasted increase in grant funding in 2023 is from the Alberta Clean Energy Technology Accelerator (ACETA) Program. This is a third-party grant fully offset by increases to external service costs.

10.2 CALCULATION OF RATE BASE

(in millions of dollars)

	2021 Actual	2022 Budget	2022 Projected	2023 Proposed	2024 Proposed	2025 Forecast	2026 Forecast
Investments in Tangible Capital Assets							
Gross Book Value - Non Contributed	\$ 581.65	\$ 635.88	\$ 615.35	\$ 659.72	\$ 698.80	\$ 728.60	\$ 752.79
Gross Book Value - Contributed	32.49	41.96	32.82	38.58	39.82	39.82	39.82
Gross Book Value - All Assets	614.14	677.84	648.17	698.30	738.61	768.42	792.61
Accumulated Depreciation - Non Contributed	283.59	315.02	307.98	333.79	362.26	393.05	425.35
Accumulated Depreciation - Contributed	11.38	12.73	12.76	13.97	15.28	16.70	18.09
Accumulated Depreciation - All Assets	294.98	327.75	320.73	347.75	377.54	409.75	443.44
Net Book Value - Non Contributed	298.06	320.86	307.37	325.93	336.54	335.55	327.44
Net Book Value - Contributed	21.10	29.23	20.06	24.61	24.54	23.12	21.73
Net Book Value - All Assets	\$ 319.16	\$ 350.09	\$ 327.43	\$ 350.54	\$ 361.08	\$ 358.67	\$ 349.17
Mid-Year Non-Contributed Assets	287.96	316.90	302.71	316.65	331.23	336.05	331.50
Cash Flow Requirement One Month Operations	15.83	16.21	16.78	17.39	17.89	18.34	18.67
RATE BASE AT MID YEAR	\$ 303.79	\$ 333.11	\$ 319.49	\$ 334.04	\$ 349.13	\$ 354.38	\$ 350.16

10.3 RETURN ON RATE BASE

(in millions of dollars)

Line #	2021 Actual	2022 Budget	2022 Projected	2023 Proposed	2024 Proposed	2025 Forecast	2026 Forecast
1	\$ 303.79	\$ 333.11	\$ 319.49	\$ 334.04	\$ 349.13	\$ 354.38	\$ 350.16
	Mid-Year Capital Structure						
2	75.0%	70.0%	71.8%	66.9%	64.2%	62.9%	61.9%
3	25.0%	30.0%	28.2%	33.1%	35.8%	37.1%	38.1%
	Cost Rates						
4	2.7%	2.5%	2.6%	2.5%	2.4%	2.5%	2.5%
5	6.9%	3.8%	1.8%	1.7%	1.3%	0.5%	0.5%
	Weighted Average Cost of Debt						
	3.8%	2.9%	2.4%	2.2%	2.0%	1.7%	1.7%
	Return on Rate Base						
6	8.24	8.23	8.29	8.21	8.53	8.76	8.77
7	20.89	12.79	5.91	5.57	4.65	1.72	1.61
	Total Return						
	\$ 29.13	\$ 21.02	\$ 14.20	\$ 13.77	\$ 13.17	\$ 10.49	\$ 10.38

Return on Rate Base is the net income/(loss) as a percentage of the Mid-Year Rate Base. The positive return on rate base is indicative of the high priority and focus that the Waste Services utility places on financial sustainability and the need to meet Pay-As-You-Go capital requirements.

11. CAPITAL BUDGET & FORECAST PLAN

11.1 CAPITAL PROJECT SUMMARY

As part of the 25-year Waste Strategy and business planning process, the Waste Services utility has placed greater emphasis on delivering strategic program changes through focused prioritization and realignment of the capital plan. Significant improvements have been made in the capital program over the past few years as a result of continuous improvement and in response to audit recommendations. Aligned with the City's Project Development and Delivery Model (PDDM), a comprehensive program and project management process was developed and is used from project initiation, justification (business case development), prioritization, budget development and expenditure tracking, to project delivery and close-out. Emphasis is placed on ensuring sustainability and growth in assets, and to meet the regulatory requirements through proper program planning and delivery.

In the current four-year budget cycle, a total of \$144.4 million has been allocated to 10 capital profiles. This includes funding for significant, multi-year, key profiles such as Three-stream Communal Collection, Facility and Infrastructure Construction and Upgrades, and Fleet Assets Replacement. Beyond 2027, an additional \$32.41 million has been previously approved for the Three-stream Communal Collection and Mayfield (NW) Eco Station initiatives for a total approval of \$176.85 million.

The utility will continue to follow the developed best practices that appropriately balance growth, process efficiency improvements, rehabilitation and regulatory requirements. An asset-management philosophy focused on safety, reliability and risk management has been incorporated into future capital planning by implementing a percentage of asset replacement value into the capital plan. This ensures proactive maintenance and repair based on asset condition assessment, safety, security and environmental requirements.

2023-2030 Capital Project Summary

(in millions of dollars)

Line #	Capital Projects	Proposed 4 Year Budget				2023-2026 Total	Forecast				2023-2030 Total
		2023	2024	2025	2026		2027	2028	2029	2030	
Branch-wide											
1	Waste Services Facilities, Infrastructure & Process Equipment	\$ 4.23	\$ 6.79	\$ 5.28	\$ 3.11	\$ 19.41	\$ 3.18	\$ 3.26	\$ 3.34	\$ 3.42	\$ 32.60
2	Waste Services IIS Infrastructure Planning and Design	1.08	0.89	0.18	0.12	2.27	0.13	0.13	0.13	0.13	2.79
3	Waste Services IIS Infrastructure Delivery	1.95	7.12	6.33	5.10	20.50	5.22	5.34	5.47	5.60	42.13
4		7.26	14.80	11.79	8.33	42.18	8.53	8.73	8.94	9.15	77.52
Collection Services Facilities											
5	Mayfield (NW) Eco Station	-	-	-	-	-	6.85	6.93	-	-	13.78
6		-	-	-	-	-	6.85	6.93	-	-	13.78
Sustainable Waste Processing Facilities											
7	Materials Recovery Facility (MRF) Renewal	4.61	-	-	-	4.61	-	-	-	-	4.61
8	Landfill Gas to Renewable Natural Gas (RNG)	9.67	3.32	-	-	12.99	-	-	-	-	12.99
9	HSADF Digestate Screening and Mixing System	5.80	-	-	-	5.80	-	-	-	-	5.80
10		20.08	3.32	-	-	23.40	-	-	-	-	23.40
Vehicles & Equipment											
11	Waste Containers	3.38	4.02	4.23	4.50	16.13	4.61	4.72	4.83	4.94	35.22
12	Waste Services Fleet Assets	6.74	9.76	9.57	8.18	34.25	8.37	8.57	8.77	8.98	68.94
13	Waste Services Fleet Assets (Pre-approved in Sept 2022)	5.10	5.73	-	-	10.83	-	-	-	-	10.83
14		15.22	19.51	13.80	12.68	61.21	12.98	13.29	13.60	13.92	114.99
Waste Program Changes											
15	Three-stream Communal Collection	7.32	1.52	1.55	-	10.39	-	0.10	0.09	4.66	15.24
16		7.32	1.52	1.55	-	10.39	-	0.10	0.09	4.66	15.24
Profile Pending Approval											
17	Energy Transition and Climate Resilience	0.25	1.17	2.67	3.18	7.27	3.25	3.33	3.40	3.48	20.73
18	Provision for Future Capital Projects	-	-	-	-	-	3.50	3.50	3.50	3.50	14.00
19		0.25	1.17	2.67	3.18	7.27	6.75	6.83	6.90	6.98	34.73
20	Grand Total	\$ 50.13	\$ 40.31	\$ 29.80	\$ 24.20	\$ 144.44	\$ 35.11	\$ 35.87	\$ 29.53	\$ 34.70	\$ 279.65

Line 1 - Waste Services Facilities, Infrastructure & Process Equipment Composite

This composite profile provides capital funding for planning and design and project delivery, which will be managed internally by the Waste Services utility. In the previous budget cycle, planning and design and project delivery were segregated into separate profiles, however due to the smaller values of these projects, it is more efficient to administer them within one profile while still maintaining capability to track the phased work. The scope of the Facilities, Infrastructure and Process Equipment profile includes the capital renewal and upgrade of existing assets due to new or increased waste streams, safety concerns and design improvements that increase the efficiency of the utility's operations. This also includes implementation of an asset management program to deliver and maintain optimal service levels. Projects are prioritized using a process that identifies and ranks projects based on strategic criteria such as environmental impact, health and safety, and alignment to strategy. Please refer to Appendix B1 for the Capital Funding Request to support this profile. All projects managed by IIS and some of the larger projects managed by the Waste Services utility will follow the Project Development and Delivery Model (PDDM) process.

Projects anticipated to be undertaken in this budget cycle include, but are not limited to:

- Advanced Energy Research Facility Renewal to extend the service life and reduce energy costs and GHG emissions.
- Cure Site Concrete Rehabilitation
- Edmonton Waste Management Centre Geoware Upgrades
- Coronation Eco Station Groundwater Wells
- Refuse Derived Fuel Facility Fire Protection Regulatory Upgrades

Lines 2 & 3 - Waste Services Planning and Design and Project Delivery Composite (IIS Managed)

These composite profiles provide capital funding for planning and design and for project delivery for projects managed by Integrated Infrastructure Services (IIS). The profiles provide a budget to support concept level planning for major capital initiatives in accordance with the City's Project Development and Delivery Model (PDDM). Projects have been identified and prioritized based on strategic criteria such as environmental impact, health and safety and alignment with the utility's and corporate goals. Please refer to Appendices B2 and B3 for the Capital Funding Requests to support these profiles.

Projects anticipated to be undertaken in this budget cycle include, but are not limited to:

- Wastewater Discharge Expansion to connect the Edmonton Waste Management Centre groundwater diversion system and sanitary infrastructure to the EPCOR wastewater treatment plant.
- Edmonton Waste Management Centre Water Distribution System Upgrades to meet fire flow and operational requirements.
- Organics Tip Floor cupola to allow for proper and safe removal of equipment at the organics receiving site.
- Integrated Process and Transfer Facility Additional Metal Removal System to improve system processing and performance.
- Residential Transfer Station Pad and Buildings Upgrade to support the upgrade and replacement of aging infrastructure.

Line 7 - Materials Recovery Facility Renewal

This stand-alone profile was approved by Council in October 2020 and supports the replacement of various processing equipment and building components that will extend the life, improve efficiency, and increase the capacity of the Materials Recovery Facility.

Line 8 - Landfill Gas to Renewable Natural Gas

This stand-alone profile was approved by Council in February 2021 and includes the capital required to collect, process and convert landfill gas into renewable natural gas to manage environmental liabilities associated with the Clover Bar Landfill. Grant funding from Emissions Reduction Alberta and partnership funding from Capital Power will finance the majority of this initiative. The November 25, 2022 Landfill Gas to Renewable Natural Gas Conversion Project Update Report (CO01527 - in private) will be presented along with the 2023-2024 Rate Filing to address overall project increases, including to the capital profile. A capital budget adjustment is proposed for this profile to increase the project costs, however this is net with a larger reduction to the City-funded portion as ownership of the processing facility is shared with a project partner. A copy of the capital profile is attached in Appendix B6.

Line 9 - HSADF Digestate Screening and Mixing System

The business case for this stand-alone profile was approved by Council in September 2022 for the removal of non-organic material (garbage) from compost to improve compost quality and manage litter issues at the cure site. The capital profile is attached in Appendix B7 for approval of the capital funding since this did not accompany the business case in September.

Lines 11 to 12 - Waste Containers and Waste Services Fleet Assets

These composite profiles provide capital funding for waste containers and mobile equipment. The objective of these profiles is to replace existing assets at the end of their useful lives and provide funding for growth assets to support ongoing operations. This includes the purchase of steel bins and litter baskets as well as carts required to maintain the residential Source Separated Organics Program implemented in 2021. The Fleet Assets profile supports the purchase of Collections and Sustainable Waste Processing equipment such as waste collection vehicles, trailers and loaders. Please refer to Appendices B4 and B5 for the Capital Funding Requests to support these profiles

Lines 13 - Waste Services Fleet Assets

As a result of detailed reviews of equipment replacement needs and delays in delivery lead times due to supply chain challenges, \$10.83 million of equipment required for 2023 and 2024 delivery was approved by Council in September 2022. This provided the funding necessary to expedite financial commitments for fleet assets that are required to support operations over the next budget cycle.

Line 15 - Three-stream Communal Collection

This profile was approved by Council in April 2021 and provides funding for vehicles and containers to support changes to the current waste collection program offered to households receiving communal collection for the three-stream separation of waste (garbage, recycling and organics).

Line 17 - Energy Transition and Climate Resilience

This project is a placeholder for funds required to transition the utility's assets to climate resilient infrastructure to reduce carbon emissions and support the City's environmental initiatives. This may include funding for electric vehicles, charging infrastructure, building retrofits, solar energy conversion, or other renewable energy and climate adaptation-related projects. In early 2023, the Waste Services utility will work with the Environment and Climate Resilience section and other internal stakeholders on gathering information and options analysis to define project scopes that optimally meet both corporate and the utility's goals. Once the projects are more defined, a business case for approval of the requested funding will be presented to Council in 2023.

Line 18 - Provision for Future Capital Projects

Although detailed capital plans for the period 2027 to 2030 have yet to be developed, the Waste Services utility anticipates that future additional capital outlays will be required.

11.2 CAPITAL PROJECT FINANCING SUMMARY

(in millions of dollars)

Line #	Source of Financing	Proposed 4 Year Budget					Forecast				
		2023	2024	2025	2026	2023-2026 Total	2027	2028	2029	2030	2023-2030 Total
1	Self Liquidating Debentures	\$ 21.92	\$ 22.62	\$ 20.05	\$ 15.89	\$ 80.48	\$ 15.11	\$ 13.67	\$ 2.12	\$ 22.10	\$ 133.48
2	Pay As You Go Requirement	22.45	16.46	9.75	8.30	56.96	12.00	12.20	12.41	12.60	106.17
3	Provincial Grants & Partnership Funding	5.76	1.24	-	-	7.00	-	-	-	-	7.00
	Total Capital Project Financing	\$ 50.13	\$ 40.32	\$ 29.80	\$ 24.19	\$ 144.44	\$ 35.11	\$ 35.87	\$ 29.53	\$ 34.70	\$ 279.65

Line 1 - Self Liquidating Debentures

Self Liquidating Debentures are coordinated through the City of Edmonton and drawn from the Government of Alberta (formerly the Alberta Capital Financing Authority) in accordance with the City of Edmonton's Debt Management Fiscal Policy C203C⁵. The cost of debt varies according to economic conditions and length of term (see Section 3.0). Details on debt servicing costs are provided in Schedule 9.0.

Line 2 - Pay-As-You-Go Requirement

With the approval of the Waste Services Utility Fiscal Policy C558B on December 9, 2020, Pay-As-You-Go (PAYG) requirements continue to be incorporated into the Financial Indicators calculation for Positive Cash Position as illustrated in Section 6.0 Financial Indicators. This term is used to identify the portion of a given capital project which is funded by cash (equity). The PAYG Requirement for the succeeding year is used in calculating a given year's target cash position.

Line 3 - Provincial Grants & Partnership

A significant portion of the Landfill Gas to Renewable Natural Gas project is funded by a \$7 million grant from Emissions Reduction Alberta. The full \$10 million grant is split between the City of Edmonton and its project partner.

⁵ A new City of Edmonton Debt Management Fiscal Policy (C203D) has been developed and will be presented to Council in Q1 2023. The Waste Services Utility Fiscal Policy C558B will be reviewed at that time to ensure alignment to the new City policy.

12. LANDFILL CLOSURE & RELATED LIABILITIES

The utility's landfills include a Class II and Class III landfill which are currently being prepared for complete closure and reclamation in accordance with operating approval from Alberta Environment and Parks. The Clover Bar Landfill (Class II) opened in 1975 and was Edmonton's first engineered sanitary landfill, featuring groundwater diversion, leachate treatment and environmental monitoring. The landfill, which lasted 20 years longer than expected due to recycling programs starting in 1988, reached full capacity and was closed in August 2009. The Class III landfill, originally established for the 1987 tornado debris, ceased operations in 2008 and was closed in 2022.

Pursuant to the *Alberta Environmental Protection and Enhancement Act*, the utility is required to fund the closure of the landfill and provide for post-closure care of the site. Closure and post-closure activities include the final clay cover, landscaping, surface and groundwater monitoring, leachate control, landfill gas management and visual inspection. The minimum period for post-closure care is 25 years and the landfill closure and post-closure care plans are based on engineering assessment of current ground conditions, leachate levels, geology, and various other environmental and regulatory conditions.

The costs to close and maintain solid waste landfill sites are based on estimated future expenses, adjusted for inflation and discounted to current dollars. These costs are reported as a liability on the Statement of Financial Position in accordance with Canadian Public Sector Accounting Standards (PSAS). The landfill liability is reviewed at regular intervals to ensure the balance is sufficient with the latest review performed for the 2023-2024 Rate Filing in September 2022 by an external consultant. Future events, such as changes to regulatory requirements, and/or changes in ground conditions, leachate levels, etc., may result in changes to the estimated cost and will be recognized prospectively as an adjustment to the reported liability, when applicable.

The following table summarizes the estimated liability and expected disbursements required to complete closure activities.

(in millions of dollars)

Line #	Reference	2021 Actual	2022 Projected	2023 Proposed	2024 Proposed	2025 Forecast	2026 Forecast
1	Reported Landfill Liability - Opening Balance	\$ 40.41	\$ 45.56	\$ 50.76	\$ 33.61	\$ 31.95	\$ 16.40
2	Less: Disbursements During the Year	(2.53)	(2.00)	(17.15)	(1.66)	(15.56)	(0.26)
3	Liability Balance after Disbursements	37.88	43.56	33.61	31.95	16.40	16.14
4	Liability Increase/(Decrease) Required	7.69	7.20	-	-	-	-
5	Expected Landfill Liability at Year End	45.56	50.76	33.61	31.95	16.40	16.14
6	Restricted Cash - Opening Balance	23.50	22.24	22.00	8.95	11.40	(0.06)
7	Add: Provision Collected through Rates to Fully Fund Liability	1.27	1.76	4.10	4.10	4.10	4.10
8	Less: Disbursements During the Year	(2.53)	(2.00)	(17.15)	(1.66)	(15.56)	(0.26)
9	Restricted Cash at Year End	22.24	22.00	8.95	11.40	(0.06)	3.79
10	Unfunded Liability (Line 9 minus Line 5)	(23.32)	(28.76)	(24.66)	(20.56)	(16.46)	(12.36)
11	Cash Balance after Disbursements	Sch. 6.0 83.48	76.46	45.45	40.87	28.40	32.76
12	Less: Target Cash Position (Pay As You Go + Risk)	Sch. 6.0 14.89	26.08	18.20	11.47	10.09	13.71
13	Cash Over Target	Sch. 6.0 \$ 68.59	\$ 50.38	\$ 27.25	\$ 29.40	\$ 18.31	\$ 19.05

The utility anticipates closure activities such as design and construction of stormwater management, leachate collection, landfill gas collection, final clay cover, landscaping, etc. to be completed by the end of 2025 for the Class II Clover Bar Landfill. From the time of final closure, the minimum period for post-closure care is expected to be 25 years and includes operating and maintenance activities such as (but is not limited to) final cover inspection and maintenance, landfill gas collection and flare system maintenance, and leachate monitoring, treatment and disposal. Significant changes to cost estimates in the future may result in an adjustment to the landfill liability and subsequently the annual landfill provision.

The reported liability for landfill closure and post-closure care on the Statement of Financial Position as at December 31, 2021 was \$45.6 million, per line 5. An adjustment is required in 2022 to increase the liability by \$7.2 million, per line 4. This increase is primarily associated with higher than previously anticipated costs required to construct the Class II landfill, slurry wall, and leachate system and to provide riverbank fortification. As a result, the liability is estimated to be \$50.8 million by the end of 2022, per line 5, in alignment with the September 2022 external consultant review.

The utility currently maintains \$22.2 million in restricted cash for the landfill liability, per line 9. The amount of unfunded liability that remains to be collected from ratepayers each year based on the expected liability balance and cash disbursement for planned construction activities is shown on line 10. Including the full unfunded liability balance under the utility's revenue requirement in any given

year would result in significant rate increases for ratepayers. To mitigate this, the utility, through the 2022 Rate Filing, received approval to collect \$1.8 million annually for 25 years to fully fund the landfill liability, as shown on line 7. Collecting the required sum over the full term of the post-closure period will minimize the impact to ratepayers and allow the utility to maintain stable and consistent rates while fulfilling the obligation for this liability. This provision has been increased from \$1.8 million to \$4.1 million for 2023 and 2024 to reflect the increase in the estimated liability from \$45.6 million to \$50.8 million and fund upcoming remediation activities.

The restricted cash of \$22.2 million will be used to fund closure costs up to 2025, per line 9. The restricted cash balance in 2025 is estimated to be fully depleted after accounting for the collection of \$4.1 million through rates and estimated disbursements for closure activities during the year. However, as can be observed from line 11 and line 13 of the table above, the utility's projected cash position in each year after accounting for landfill disbursements and PAYG cash required to fund capital expenditures is positive, and sufficient to fulfill the estimated landfill obligations.

13. SEGMENTED REPORTING - PROGRAM REVENUES & EXPENSES

(in millions of dollars)

WASTE COLLECTION SERVICES

Line #	2021 Actual	2022 Budget	2022 Projected	2023 Proposed	2024 Proposed	2025 Forecast	2026 Forecast
1 Personnel	\$ 28.20	\$ 27.24	\$ 27.24	\$ 29.35	\$ 31.03	\$ 31.62	\$ 32.23
2 Materials, Goods & Supplies	1.07	1.19	1.19	1.11	1.13	1.15	1.17
3 External Services	29.34	33.13	33.13	36.15	35.83	36.54	37.30
4 Fleet Services	7.43	7.32	7.32	8.72	8.65	8.56	8.56
5 Intra-municipal Services	1.94	1.96	1.96	1.96	1.96	1.96	1.96
6 Utilities	0.60	0.86	0.86	0.84	0.86	0.88	0.89
7 Other Expenses	0.69	1.39	1.39	1.50	1.51	1.55	1.58
SUBTOTAL	69.27	73.09	73.09	79.63	80.96	82.25	83.69
8 Intra-municipal Recoveries	(1.24)	(2.21)	(2.21)	(0.53)	(0.50)	(0.50)	(0.50)
TOTAL O&M EXPENSES	68.03	70.89	70.89	79.10	80.46	81.75	83.19
9 Amortization of Non-Contributed Assets	5.90	8.86	8.96	10.19	11.79	13.23	13.70
10 Debt Interest	1.28	1.92	1.40	1.44	1.62	1.86	2.06
EXPENSES BEFORE ONE-TIME	75.21	81.67	81.24	90.73	93.86	96.84	98.95
11 Grant Revenue	7.61	-	-	-	-	-	-
12 Program Revenues	5.86	4.14	4.14	5.94	6.07	6.28	6.41
13 Rate Revenues	61.74	77.53	77.10	84.79	87.79	90.56	92.53
NET INCOME/(NET LOSS)	-	-	-	-	-	-	-

Note: Program and Rate Revenues sufficient to achieve a net income of zero are transferred from Collection Services to Sustainable Waste Processing. The net income for the Waste Services Utility is therefore wholly contained within Sustainable Waste Processing.

SUSTAINABLE WASTE PROCESSING

Line #		2021 Actual	2022 Budget	2022 Projected	2023 Proposed	2024 Proposed	2025 Forecast	2026 Forecast
1	Personnel	\$ 20.18	\$ 23.82	\$ 23.82	\$ 26.27	\$ 26.73	\$ 27.20	\$ 27.71
2	Materials, Goods & Supplies	2.40	2.60	2.60	1.87	1.87	1.86	1.90
3	External Services	44.90	48.01	48.01	51.42	54.03	55.91	57.16
4	Fleet Services	6.54	8.41	8.41	7.45	7.03	7.12	7.09
5	Shared Services	9.72	10.08	10.08	10.42	10.52	10.62	10.73
6	Intra-municipal Services	2.61	3.79	3.79	4.13	4.19	4.18	4.23
7	Utilities	3.01	4.31	4.31	5.54	5.73	5.91	6.04
8	Other Expenses	8.11	2.24	9.44	2.30	2.33	2.34	2.35
	SUBTOTAL	97.46	103.26	110.46	109.40	112.42	115.16	117.21
9	Intra-municipal Recoveries	0.14	(4.78)	(4.78)	(3.01)	(2.90)	(2.90)	(2.97)
	TOTAL O&M EXPENSES	97.60	98.47	105.67	106.39	109.52	112.25	114.23
10	Amortization of Non-Contributed Assets	17.34	15.82	15.47	15.62	16.69	17.56	18.61
11	Amortization of Regulatory Asset	3.91	3.91	3.91	3.91	3.91	3.91	3.25
12	Debt Interest	6.96	6.31	6.90	6.77	6.91	6.90	6.72
	EXPENSES BEFORE ONE-TIME	125.80	124.51	131.95	132.68	137.01	140.62	142.81
13	Grant Payment	-	-	-	0.02	-	-	-
14	Grant Revenue	0.46	-	-	0.40	-	-	-
15	Program Revenues	8.82	8.87	8.87	10.24	11.21	10.92	11.49
16	Rate Revenues	137.41	128.42	128.98	127.61	130.46	131.42	132.93
	NET INCOME/(NET LOSS)	\$ 20.89	\$ 12.79	\$ 5.91	\$ 5.56	\$ 4.65	\$ 1.72	\$ 1.61

Note: Program and Rate Revenues sufficient to achieve a net income of zero are transferred from Collection Services to Sustainable Waste Processing. The net income for the Waste Services Utility is therefore wholly contained within Sustainable Waste Processing.

13.1 REVENUES & EXPENSES BY REGULATED AND NON-REGULATED PROGRAM

(in millions of dollars)

REGULATED PROGRAMS

Line #	2021 Actual	2022 Budget	2022 Projected	2023 Proposed	2024 Proposed	2025 Forecast	2026 Forecast
1 Personnel	\$ 45.39	\$ 48.92	\$ 48.92	\$ 52.57	\$ 54.67	\$ 55.68	\$ 56.73
2 Materials, Goods & Supplies	2.47	2.32	2.33	2.13	2.16	2.20	2.24
3 External Services	70.33	77.06	77.06	82.84	85.13	87.56	89.47
4 Fleet Services	12.43	14.44	14.44	15.18	14.68	14.66	14.63
5 Shared Services	9.72	10.08	10.08	10.42	10.52	10.62	10.73
6 Intra-municipal Services	6.28	5.52	5.52	6.20	6.28	6.27	6.31
7 Utilities & Others	12.19	8.59	15.79	9.95	10.16	10.39	10.57
SUBTOTAL	158.80	166.93	174.14	179.29	183.59	187.38	190.68
8 Intra-municipal Recoveries	(0.14)	(1.00)	(1.00)	0.21	0.27	0.25	0.23
O & M EXPENSES	158.66	165.94	173.14	179.50	183.86	187.63	190.91
9 Amortization of Non-Contributed Assets	20.31	23.86	23.62	25.12	27.83	30.18	31.68
10 Amortization of Regulatory Asset	3.91	3.91	3.91	3.91	3.91	3.91	3.25
11 Debt Interest	8.24	8.04	8.09	8.01	8.35	8.60	8.62
EXPENSES BEFORE ONE-TIME	191.12	201.74	208.75	216.54	223.94	230.31	234.46
12 Grant Payment	-	-	-	0.02	-	-	-
13 Grant Revenue	0.46	-	-	0.40	-	-	-
14 Program Revenues	8.23	8.54	8.54	9.32	10.47	10.26	10.82
15 Rate Revenues	199.14	205.95	206.08	212.40	218.25	221.99	225.46
NET INCOME/(LOSS)	\$ 16.71	\$ 12.75	\$ 5.87	\$ 5.59	\$ 4.78	\$ 1.94	\$ 1.83

NON-REGULATED PROGRAMS

Line #	2021 Actual	2022 Budget	2022 Projected	2023 Proposed	2024 Proposed	2025 Forecast	2026 Forecast
1 Personnel	\$ 3.00	\$ 2.14	\$ 2.14	\$ 3.04	\$ 3.08	\$ 3.14	\$ 3.21
2 Materials, Goods & Supplies	0.99	1.47	1.47	0.86	0.84	0.81	0.83
3 External Services	3.92	4.08	4.08	4.39	4.40	4.56	4.65
4 Fleet Services	1.53	1.29	1.29	0.99	0.99	1.02	1.03
5 Intra-municipal Services	(1.73)	0.22	0.22	0.23	0.20	0.21	0.21
6 Utilities	0.21	0.22	0.22	0.27	0.28	0.29	0.29
SUBTOTAL	7.92	9.42	9.42	9.77	9.78	10.03	10.21
7 Intra-municipal Recoveries	(0.96)	(5.99)	(5.99)	(3.75)	(3.67)	(3.65)	(3.71)
TOTAL O&M EXPENSES	6.97	3.42	3.42	6.02	6.11	6.37	6.51
8 Amortization of Non-Contributed Assets	2.92	0.82	0.81	0.70	0.65	0.61	0.63
9 Debt Interest	-	0.20	0.21	0.19	0.18	0.17	0.16
EXPENSES BEFORE ONE-TIME	9.89	4.44	4.44	6.91	6.94	7.15	7.29
10 Grant Revenue	7.61	-	-	-	-	-	-
11 Program Revenues	6.46	4.48	4.48	6.86	6.81	6.93	7.07
12 Rate Revenues	-	-	-	-	-	-	-
NET INCOME/(NET LOSS)	\$ 4.18	\$ 0.04	\$ 0.04	\$ (0.05)	\$ (0.13)	\$ (0.22)	\$ (0.22)

13.2 REGULATED ACTIVITIES EXPENSE CHANGES

(in millions)

Regulated Activities		2022 Projected	Customer Growth	Consumption	Inflation	New Activities (Note 1)	Activities No Longer Required (Note 2)	2023 Proposed
1	Personnel	\$ 48.92	\$ 0.25	\$ (0.36)	\$ 0.15	\$ 3.61	\$ -	\$ 52.57
2	Materials, Goods & Supplies	2.33	0.02	(0.29)	0.07	-	-	2.13
3	External Services	77.06	1.44	0.55	2.54	1.25	-	82.84
4	Fleet Services	14.44	-	0.27	0.47	-	-	15.18
5	Shared Services	10.08	-	0.07	0.25	0.08	(0.06)	10.42
6	Intra-municipal Services	5.52	-	0.55	0.18	-	(0.05)	6.20
7	Utilities & Other Expenses	15.79	-	0.84	0.52	-	(7.20)	9.95
	SUBTOTAL	174.14	1.71	1.63	4.18	4.94	(7.31)	179.29
8	Intra-municipal Recoveries	(1.00)	-	(0.95)	(0.03)	-	2.19	0.21
	O & M EXPENSES	\$ 173.14	\$ 1.71	\$ 0.68	\$ 4.15	\$ 4.94	\$ (5.12)	\$ 179.50

Regulated Activities		2023 Proposed	Customer Growth	Consumption	Inflation	New Activities (Note 1)	Activities No Longer Required (Note 2)	2024 Proposed
1	Personnel	\$ 52.57	\$ -	\$ 1.05	\$ 1.05	\$ -	\$ -	\$ 54.67
2	Materials, Goods & Supplies	2.13	0.04	(0.06)	0.05	-	-	2.16
3	External Services	82.84	1.56	(0.85)	1.58	-	-	85.13
4	Fleet Services	15.18	-	(0.50)	-	-	-	14.68
5	Shared Services	10.42	-	0.10	-	-	-	10.52
6	Intra-municipal Services	6.20	-	0.08	-	-	-	6.28
7	Utilities & Other Expenses	9.95	-	0.01	0.19	-	-	10.15
	SUBTOTAL	179.29	1.60	(0.17)	2.87	-	-	183.59
8	Intra-municipal Recoveries	0.21	-	0.06	-	-	-	0.27
	O & M EXPENSES	\$ 179.50	\$ 1.60	\$ (0.11)	\$ 2.87	\$ -	\$ -	\$ 183.86

Line 1 - Personnel

For 2023 and 2024 Inflation reflects the merit and benefit increases for current positions. In 2023 customer growth includes the addition of 3.0 FTEs for customer outreach and support and operational analytics. New activities include the addition of 46.0 FTEs for the implementation of the Communal Collection Program and the transfer of a portion of waste collection services to the City of Edmonton from contractor services. Consumption in 2023 is a correction to the four per cent wage discount as it was understated in the 2021 approved budget and in 2024 it is filling seasonal and permanent positions to support the implementation of diversion targets. For additional details on the FTE increases see Appendix A.

Line 2 - Materials Goods & Supplies

Increase reflects the increased costs related to customer growth and inflation in 2023 and 2024. In both years consumption is the reduction in hired equipment as equipment needs are being met internally.

Line 3 - External Services

Increase in consumption represents the additional costs for cart maintenance related to the Edmonton Cart Rollout and higher volume of feedstock requested from the Refuse Derived Fuel Facility. In 2024 the consumption reduction is reduced contract costs related to the transfer of waste collection from contractor services to the City of Edmonton. New activities include costs for the implementation of the Communal Collection Program.

Other contract costs include customer billing, Community Relations and Program Management, Administrative Services, and other facilities such as Eco Stations, Edmonton Waste Management Centre Operations, Advanced Energy Research Facility, Research & Development and Environmental.

Line 4 - Fleet Services

Consumption costs in 2023 reflect an increase in fuel prices without the significant gains from the City's fuel hedging activities as experienced in 2022. In 2024 fuel prices are expected to decrease and are reflected in the 2024 consumption costs.

Line 5 - Shared Services

Consumption represents increased Communication & Public Engagement costs for increased 311 costs related to the Edmonton Cart Rollout.

Line 6 - Intra-municipal Services

Consumption represents increased facilities and maintenance costs as maintenance costs are expected to increase in 2023 and 2024.

Line 7 - Utilities & Other Expenses

Consumption represents the increases to power and natural gas prices primarily associated with the Edmonton Waste Management Centre facilities such as the Integrated Processing and Transfer Facility, EWMC Site Operations and the Anaerobic Digestion Facility.

Line 8 - Intra-municipal Recoveries

Consumption costs reflect a decrease in capital recoveries in 2023 and 2024.

Note 1: New activities represent the implementation of the Communal Collection Program and the resumption of a portion of waste collection services by the City of Edmonton versus contractor services. It also includes the increase in shared service costs for the new Service Innovation & Performance branch.

Note 2: Activities no longer required represent the removal of the Shared Service for Customer Information Services. Further adjustments include a one-time adjustment to increase the post-closure liability in 2022 and a one-time adjustment to remove Commercial Collection from Intra-municipal Recoveries and move to Non-rate Revenue. For further information on the post-closure liability see Section 12 Landfill Closure & Related Liabilities.

14. HISTORICAL TRENDS

(in millions of dollars)

Line #	Reference	2017 Actual	2018 Actual	2019 Actual	2020 Actual	2021 Actual	2022 Projected	2023 Proposed	2024 Proposed	2025 Forecast	2026 Forecast	
1	Operations and Maintenance	Sch 8.0	\$ 177.15	\$ 170.90	\$ 199.36	\$ 175.12	\$ 166.72	\$ 183.55	\$ 189.03	\$ 193.38	\$ 197.40	\$ 200.90
2	Amortization of Non-Contributed Assets	Sch 9.0	20.78	22.31	21.02	21.27	23.24	24.37	25.81	28.47	30.79	32.31
3	Debt Interest	Sch 9.0	9.37	9.27	8.98	8.66	8.24	8.29	8.21	8.53	8.76	8.77
4	Intra-municipal Recoveries	Sch 8.8	(10.97)	(4.44)	(3.56)	(4.67)	(1.10)	(6.99)	(3.54)	(3.41)	(3.40)	(3.48)
5	Grants	Sch 8.0	-	1.50	3.60	1.00	-	-	0.02	-	-	-
6	Amortization of Regulatory Asset	Sch 8.0	-	-	1.31	3.25	3.91	3.91	3.91	3.91	3.91	3.25
	TOTAL EXPENSES		196.32	199.55	230.71	204.63	201.01	213.12	223.43	230.88	237.46	241.75
7	Non-Rate Revenue	Sch 10.1	35.88	39.30	30.84	19.00	22.75	13.02	16.58	17.28	17.19	17.90
8	Rate Revenue	Sch 10.0	171.22	178.38	185.86	194.70	199.15	206.01	212.41	218.24	221.99	225.47
	TOTAL REVENUES		207.10	217.68	216.70	213.70	221.90	219.03	228.99	235.52	239.18	243.36
	NET INCOME/(LOSS)	Sch 13.0	\$ 10.78	\$ 18.13	\$ (14.01)	\$ 9.07	\$ 20.89	\$ 5.91	\$ 5.56	\$ 4.65	\$ 1.72	\$ 1.61

Waste Services Utility Customer Counts

	2017 Actual	2018 Actual	2019 Actual	2020 Actual	2021 Actual	2022 Projected	2023 Proposed	2024 Proposed	2025 Forecast	2026 Forecast
Single Unit	214,900	219,973	224,129	232,643	236,304	235,688	238,856	241,669	250,477	264,628
Multi Unit	174,196	175,519	178,751	177,383	182,246	183,843	188,510	193,268	188,119	177,637
Total	389,096	395,492	402,880	410,026	418,550	419,531	427,366	434,937	438,596	442,265

Note: The table above includes the reclassification of 7,233 customers from Multi-unit (Communal) to Single Unit (Curbside) in 2020 and 12,572 in 2021. Refer to Section 3.0 for additional information.

All Customer Counts shown represent December 31 balances (estimates). For budget and forecast purposes the utility rates are calculated using a phased-in increase to Customer Counts over a given year to ensure representation of consistent growth. As a result, mid-year customer counts are used in these calculations.

APPENDIX A: OPERATING BUSINESS CASES & NEW FTE JUSTIFICATIONS

Operating Business Cases

There are no Waste Services Utility Operating Business Cases for the 2023-2024 Rate Filing.

New FTE Justifications for Additional Resources (2023-2024 Operating Budget)

- A1: Collection Services Staff
- A2: Business Integration Customer Support Centre Staff
- A3: Business Integration Communal Collection Support Staff
- A4: Business Integration Methods Analyst I

APPENDIX A1: Collection Services Staff

1. DESCRIPTION

The Waste Services utility is recommending that the addition of 14 FTEs be approved for funding in the 2023-2024 Waste Services Operating Budget at a total budget increase of \$1,194,295 (based on full year operational requirement). The following is a description of the positions requested.

2. JUSTIFICATION

Communal collection is provided by both City of Edmonton staff and contracted staff. The utility intends to transfer a portion of waste collection from contractor service to City of Edmonton staff by recruiting seven collection vehicle operators and seven swampers (a swamper is a second person on a waste collection vehicle that assists in waste collection of bins while ensuring safe operations). Returning to City-delivered waste collection will revert the distribution of City and contracted service in the multi-unit sector to an approximate 50/50 split. This is the current distribution in the Curbside collection service delivered to residents.

Increasing the vehicle fleet and staff complement provides a surety of service in the multi-unit sector, lowering risk and reducing the likelihood of the inability to deliver waste collection to contractor-served areas should a contractor fail.

The additional vehicles are forecasted to begin arriving in Q3 2023 and the proposed positions are expected to be hired just in advance of the arrival of the vehicles to allow for training. City staff will assume waste collection as soon as reasonably possible as the current contract extension allows for this opportunity.

Financial analysis has found that City staff service delivery compared to that of contractors is comparable in terms of cost to the utility.

3. RISK ASSOCIATED WITH NOT HIRING

Not hiring these positions leaves the surety of service risk to contractor served areas unmitigated. This could result in missed scheduled pickups and other service interruptions resulting in resident complaints.

The alternative to hiring these staff is to continue to use contracted service providers. By continuing to provide service in this manner, the utility will continue to experience risk related to service disruptions and incidents of missed collections.

APPENDIX A2: Business Integration Customer Support Centre Staff

1. DESCRIPTION

The Waste Services utility is recommending that the addition of two FTEs be approved for funding in the 2023-2024 Waste Services Operating Budget at a total budget increase of \$169,500 (based on full year operational requirement). The following is a description of the positions requested.

2. JUSTIFICATION

The Customer Support Team contributes to a positive customer experience for residents by handling resident inquiries and escalations in a timely manner. The team also escalates issues, such as incidents of missed collections and property damage, to the correct area through the creation of notification orders.

Prior to the implementation of the Edmonton Cart Rollout, the Customer Support Team team was expanded from 4.5 permanent FTEs to 5.5 permanent FTEs and 10 temporary FTEs in anticipation of increased inquiries. In 2021, the team saw an 82 per cent increase in inquiries and a 48 per cent increase in notification orders generated over 2020 levels.

It was expected that the volume of inquiries and escalations would decrease significantly after the cart rollout concluded; however, this has not been the case. An inquiry analysis and workload forecast conducted earlier in 2022 has shown that inquiry volumes have remained on par with 2021, while notification orders have actually increased by 40 per cent over 2021. Based on this trend, it is unlikely that a decline in workload will be seen in 2023, especially as new programs are introduced to Edmontonians (including a new bylaw on single-use items).

It should also be noted that the introduction of a new billing and customer management system in December 2020 has increased the time required by the team to process notification orders. This compounds the impact of the increased escalations received on the team's workload.

The Customer Support Team currently operates with one supervisor, 3.5 FTEs and four temporary FTEs whose terms end in November 2022 (2), January 2023 (1) and February 2023 (1). Two other permanent FTEs are on extended leave, with one anticipated to return in March 2023, and the other with no expected return date. Team members have already needed to work significant amounts of overtime to handle surges in inquiries. As well, other work required for the long-term functioning of the team, such as the updating of training materials, has been deferred in order to keep up with inquiries.

If these positions are not hired, there will be a decline in customer experience. These positions are expected to be hired in Q1, 2023, and are fully funded through the Customer Support Centre's operational budget.

3. RISK ASSOCIATED WITH NOT HIRING

Customer experience will decline if these positions are not hired. The time required to respond to inquiries and escalations will increase, and requests for overtime will increase, which contributes to staff burnout. In the past, delayed responses to escalations have also resulted in increases in councilor inquiries.

Additionally, not hiring these positions will increase overtime costs and impact the ability to complete some of the tasks required for continuous improvement, especially due to the upcoming service changes, and will further reduce the ability to log information from customers that can help with decision-making.

APPENDIX A3: Business Integration Communal Collection Support Staff

1. DESCRIPTION

The Waste Services utility is recommending that the addition of 32 FTEs be approved for funding in the 2023-2024 Waste Services Operating Budget at a total budget increase of \$2,420,159 (based on full year operational requirement). The following is a description of the positions requested.

- 14 FTEs for the collection of food scraps and recycling,
- One FTE for the delivery and maintenance of waste containers,
- Three FTEs for liaising with properties and managing contractors,
- Three FTEs for routing, development review and approvals, and liaising with developers,
- Two FTEs for customer support and addressing inquiries, and
- Nine FTEs for the design, development and delivery of educational programs to residents and property managers.

2. JUSTIFICATION

The positions requested will assist with implementing the Three-stream Communal Collection Business Case approved by Council in April 2022 (CO00581rev). The positions requested include waste collectors and inspectors, education and communication personnel, and customer support staff. It is expected that the majority of these positions would be hired in Q2 or Q3 of 2023.

The Communal Collection Program is intended to introduce mandatory, co-located, three-stream source separation of waste to all residential properties receiving communal collection. The funding for these positions has been approved by Council (CO00581rev) and will be funded through utility rates.

3. RISK ASSOCIATED WITH NOT HIRING

Not hiring these positions would result in jeopardizing the ability to implement the Communal Collection Program or greatly compromise the quality in which it is implemented.

Specific risks include, but are not limited to, delays in the implementation schedule, inability to provide the appropriate tools and support for residents, property managers, and developers to adapt to this new program, and the inability to collect three streams of waste from properties due to lack of resources.

The unsuccessful implementation of this program will pose significant reputational risk to the City and cause inequity between residents living in single unit homes and multi-unit residences.

The alternative to not approving these positions is to reconsider the Three-stream Communal Collection Business Case.

APPENDIX A4: Business Integration Methods Analyst I

1. DESCRIPTION

The Waste Services utility is recommending that the addition of one FTE be approved for funding in the 2023-2024 Waste Services Operating Budget at a total budget increase of \$80,000 (based on full year operational requirement). The following is a description of the position requested.

2. JUSTIFICATION

The position, funded by the operating budget, will be used to complete analytical tasks, including but not limited to:

- Management of Enterprise Performance Management, including oversight of key performance indicators and recommendations to senior management for action.
- Forecasting of key data, including collection and tonnage processing, used to inform resourcing decisions.
- Lead complex and detailed investigations and analysis related to residential utility billing.

The position is expected to be hired in Q1 2023.

3. RISK ASSOCIATED WITH NOT HIRING

Based on current staffing levels, the above noted action items are unable to be completed at this time. The Waste Services utility has been working closely with Department partners on actioning these items, however, a dedicated resource housed within the utility is best positioned to provide these outcomes. Without this position, less timely and specialized information would be available for management decision making which could result in reactive responses to emerging issues and trends (versus being proactive).

APPENDIX B: CAPITAL FUNDING REQUESTS & CAPITAL PROFILES

The following Capital Funding Requests and capital profiles provide additional information for budget adjustments related to initiatives noted under Schedule 11.0 Capital Budget & Forecast Plan:

- Capital Profile Report Guide

- B1: Waste Services Facilities, Infrastructure & Process Equipment Capital Funding Request
- B1a: Waste Services Facilities, Infrastructure & Process Equipment Capital Profile

- B2: Waste Services IIS Infrastructure Planning and Design Capital Funding Request
- B2a: Waste Services IIS Infrastructure Planning and Design Capital Profile

- B3: Waste Services IIS Infrastructure Delivery Capital Funding Request
- B3a: Waste Services IIS Infrastructure Delivery Capital Profile

- B4: Waste Containers Composite Capital Funding Request
- B4a: Waste Containers Capital Profile

- B5: Waste Services Fleet Assets Composite Capital Funding Request
- B5a: Waste Services Fleet Assets Capital Profile

- B6: Landfill Gas to Renewable Natural Gas Capital Profile
 - The cashflow shown in this profile does not reflect the actual timing of spend within the 2023-2026 Capital Budget from Schedule 11, however the total budget remains the same. Due to budgeting reporting requirements, the cashflow must follow the original schedule in the capital profile, however the unspent budget will be carried forward to future years.

- B7: HSADF Digestate Screening and Mixing System Capital Profile

- B8: Cure Site Land Use & Development Capital Profile
 - The remaining \$6.2 million approved budget in the Cure Site Land Use & Development profile originating from the 2015-2018 budget cycle has been removed from the capital schedule due to changes in organics processing strategies. Budget cancellation has been proposed and justified in Council report CO01380.

- B9: Mayfield Eco Station Capital Profile

- B10: Three-stream Communal Collection Capital Profile

CAPITAL PROFILE REPORT GUIDE

RECOMMENDED: This is a new capital profile that has a budget request to be approved by City Council.

RECOMMENDED	
PROFILE STAGE:	Council Review
PROFILE TYPE:	Standalone
LEAD MANAGER:	Lead Branch Manager
PARTNER MANAGER:	Partner branch Manager
ESTIMATED START:	January, 2023
ESTIMATED COMPLETION:	December, 2026
Project Initiative:	
PREVIOUSLY APPROVED:	-
BUDGET REQUEST:	69,000
TOTAL PROFILE BUDGET:	69,000

This is the budget amount that is being requested in this budget cycle.

RECOMMEND FUNDED: This is a profile that is previously approved by City Council which has a budget request.

RECOMMENDED FUNDED	
PROFILE STAGE:	Approved
PROFILE TYPE:	Composite
LEAD MANAGER:	Lead Branch Manager
PARTNER MANAGER:	Partner Branch Manager
ESTIMATED START:	January, 2023
ESTIMATED COMPLETION:	December, 2026
Project Initiative:	
PREVIOUSLY APPROVED:	26,698
BUDGET REQUEST:	69,414
TOTAL PROFILE BUDGET:	96,112

This is the amount approved by Council in the prior year capital budget cycle.
Note: Previously approved composite profiles with no approved budget in 2023/beyond will show as zero/blank.

This is the budget amount that is being requested in this capital budget cycle

This is the total profile budget if the budget request is approved by Council

FUNDED: This is a profile that was previously approved by City Council which does not have a budget request. However, the profile has a budget in the forecast years of the proposed capital budget cycle. This stage is also known as “Approved.”

FUNDED	
PROFILE STAGE:	Approved
PROFILE TYPE:	Standalone
LEAD MANAGER:	Craig Walbaum
PARTNER MANAGER:	Gord Cebryk
ESTIMATED START:	May, 2019
ESTIMATED COMPLETION:	December, 2022
or Initiative: Great Neighbourhoods	
PREVIOUSLY APPROVED:	53,436
BUDGET REQUEST:	-
TOTAL PROFILE BUDGET:	53,436

This amount is approved by City Council in the prior year/budget cycle.

No budget request in this budget cycle.

UNFUNDED: This is a profile that has not been approved by City Council and is not recommended in the proposed budget cycle. This stage is also known as “Unapproved.”

UNFUNDED	
PROFILE STAGE:	Entry - Create Profile
PROFILE TYPE:	Standalone
LEAD MANAGER:	Lead Branch Manager
PARTNER MANAGER:	Partner branch Manager
ESTIMATED START:	January, 2023
ESTIMATED COMPLETION:	December, 2026
or Initiative:	
PREVIOUSLY APPROVED:	-
BUDGET REQUEST:	69,000
TOTAL PROFILE BUDGET:	69,000

Other Definitions

CAPITAL BUDGET AND FUNDING SOURCES (000's):

This table consists of three pieces of information. The APPROVED BUDGET line identifies the Capital Budget as approved by City Council previously (if applicable), adjusted for any subsequently approved budget adjustments. The BUDGET REQUEST line reflects any requested changes to the existing budget approval. This would include requests for increases or reductions in budget approval of the annual expenditures. The REVISED BUDGET (IF APPROVED) is the sum of the first two lines and will reflect the amount and timing of capital expenditures as proposed by the department/branch for each profile.

GROWTH:

Investment in new infrastructure that increases the size of the infrastructure portfolio.

Note: Any upgrade of an infrastructure asset before the end of its expected useful life is considered growth. For example, moving from a leased building to a new City-owned building would be considered growth.

RENEWAL:

Investment in existing infrastructure to restore to its former condition, thereby extending its service life. This may include replacement or rehabilitation of individual components as they age or become obsolete. Capital investment in renewal extends the period of service potential and does not increase the size of the infrastructure asset portfolio.

LEAD BRANCH/LEAD BRANCH MANAGER:

This is the branch and the branch manager that is responsible for the construction/project management of until the completion of the profile. This field will be populated if the Profile Manager is different from the Project Manager. For example, the Community & Recreation Facilities branch may "own" the budget to build a recreation centre, however, when the capital budget is approved, Integrated Infrastructure Services may "project-manage" the construction of the new recreation centre.

OPERATING IMPACT OF CAPITAL:

This section identifies the operating budget impacts of this capital profile and must be consistent with the information in the operating budget. Where applicable, it includes an estimate of Full-Time Equivalent human resources.

PROFILE NAME:

The unique descriptive name given to each profile.

PROFILE NUMBER:

A unique profile number is assigned to each profile and remains with that profile until project completion. The profile number consists of three components as follows; the approximate year in which the project begins, the asset category and an individual four-digit number. For example:

<u>Year</u>	<u>Asset Category</u>	<u>No.</u>
23	30	9999

Note: If the “year” shows a “CM” instead of a number, it signifies that the profile is a composite, as opposed to a standalone.

PROFILE TYPE - STANDALONE:

Includes both renewal (> \$5 million) and/or growth (> \$2 million) profiles that are completed over two or more years and have potential access to external funding. Standalone Profile budget approval is for the duration of the project even if the budget goes beyond the current Budget Cycle.

PROFILE TYPE - COMPOSITE:

A Composite profile is a collection of individual projects that fit within a common theme, typically within a larger program initiative such as the Neighbourhood Renewal Program, Arterial Overlay Program, etc. Within the composite profile are individual projects representing different locations where the work will take place, and are less than \$5 million in value individually (if a renewal composite), or \$2 million in value (if a growth composite). Each individual project within a composite is expected to be completed over a two year construction window. Composite Profile budget approval is for the Budget Cycle only (i.e. a maximum of four years).

PROJECT LIST - PERCENTAGE FUNDED

The project list that accompanies each composite capital profile includes a “percentage funded” column. This figure represents how much of the project is estimated to be funded based on available funding in the budget cycle. In most cases, the projects listed as funded on the project lists represent 80 per cent of the total profile value. At this point in the Project Development and Delivery Model (PDDM) process cost estimates for projects in composite profiles have a high degree of uncertainty. As more clarity is obtained through the PDDM process, project estimates are updated. Leaving 20 per cent of each composite profile's total approved budgets as unallocated provides funding to compensate for adjustments to cost estimates, or to fund additional priorities within the overall composite program.

CAPITAL PROFILE REPORT

PROFILE NAME: SAMPLE BASIC PROFILE	RECOMMENDED
PROFILE NUMBER: 12-34-5678	PROFILE STAGE: Council Review
DEPARTMENT: ZZ - Uncategorized	PROFILE TYPE: Standalone
LEAD BRANCH: Uncategorized	LEAD MANAGER: Lead Branch Manager
PARTNER: Uncategorized	PARTNER MANAGER: Partner branch Manager
BUDGET CYCLE: 2023-2026	ESTIMATED START: January, 2023
	ESTIMATED COMPLETION: December, 2026

Service Category: Protection	Major Initiative:
-------------------------------------	--------------------------

GROWTH	RENEWAL	PREVIOUSLY APPROVED:	-
80	20	BUDGET REQUEST:	69,000
		TOTAL PROFILE BUDGET:	69,000

PROFILE DESCRIPTION

This section describes the history leading up to the current state of affairs giving rise to or relating to the general business problem or opportunity that is the subject of the business case. It provides a brief description of the business problem or opportunity that the initiative is trying to address. (5,000 characters)

PROFILE BACKGROUND

Provides a summarized description and context for the initiative. This section briefly describes the initiative and defines parameters of the initiative. Specifically, it describes the timeframes, department/organization, function and technology (if applicable). Explains items that are specifically excluded from the initiative. (1,200 characters)

PROFILE JUSTIFICATION

Provides a summarized rationale for the initiative. This section briefly describes the justification of the initiative. It outlines what the initiative will accomplish, in clear and measurable terms within a specified time frame. These objectives can be used in a post-implementation review to assess the success of the initiative. The objectives should be formulated broadly enough so that meaningful alternatives are not ruled out and narrowly enough so that only relevant alternatives are considered and that costs and benefits can be formulated. (5,000 characters)

STRATEGIC ALIGNMENT

This section describes how the initiative aligns with and contributes to the Council Goals and strategic alignment/outcomes, and to corporate and/or departmental business plans. (600 characters)

ALTERNATIVES CONSIDERED

The section provides the reader with an outline of the realm of possibilities that are available to address the problem or opportunity. It provides the reader with rationale to why some have been eliminated as viable alternatives. (1,000 characters)

COST BENEFITS

This section identifies overall value contribution and costs incurred to realize the proposed initiative. Provides a summary of tangible/intangible benefits; summarized listing of costs to achieve the desired benefits. States assumptions and provides a degree of accuracy for the cost estimates. (500 characters)

KEY RISKS & MITIGATING STRATEGY

Some initiatives will have risks that will significantly limit or prevent the business owner from achieving their objectives. Note significant risks, for each viable alternative, with an identified mitigating strategy. (800 characters)

RESOURCES

Outlines the resourcing options for each alternative (internal and/or external) and provides justification. This is subject to approved corporate standards outlined in Administrative Directive A1439B Purchasing Goods Services & Construction. (300 characters)

CONCLUSIONS AND RECOMMENDATIONS

This section will recap the key elements of the business case and identify the proposed solution from the identified alternatives, and will make a specific recommendation on proceeding with the initiative. (800 characters)

CHANGES TO APPROVED PROFILE

(BUDGET OFFICE USE) This section only appears is there is a change request to an approved budget and is used to explain any project changes, other than project scope, which have occurred since the project was last approved. Changes to be covered include description of any budget increase/decrease which occur as a result of a change in project scope (i.e. tender price lower or higher, material cost fluctuation, transfers of funds to or from one project to another, etc.), or any shift in the mix of the funding sources originally identified. Changes may also be due to receipt of unanticipated alternative funding sources, a change in eligibility for grant funding, or the maximization of grants eligibility.

CAPITAL PROFILE REPORT

PROFILE NAME: **Sample Basic Profile**

RECOMMENDED

PROFILE NUMBER: **12-34-5678**

PROFILE TYPE: **Standalone**

BRANCH: **Uncategorized**

CAPITAL BUDGET AND FUNDING SOURCES (000's)

APPROVED BUDGET		Prior Years	2022	2023	2024	2025	2026	2027	2028	2029	2030	Beyond 2030	Total
	Approved Budget												
Original Budget Approved		-	-	-	-	-	-	-	-	-	-	-	-
Current Approved Budget		-	-	-	-	-	-	-	-	-	-	-	-

BUDGET REQUEST	Budget Request	-	-	23,000	24,000	22,000	-	-	-	-	-	-	69,000
	Revised Funding Sources (if approved)												
	Basic Grants	-	-	23,000	24,000	22,000	-	-	-	-	-	-	69,000
Requested Funding Source													

REVISED BUDGET (IF APPROVED)	Revised Budget (if Approved)	-	-	23,000	24,000	22,000	-	-	-	-	-	-	69,000
	Requested Funding Source												
	Basic Grants	-	-	23,000	24,000	22,000	-	-	-	-	-	-	69,000
Requested Funding Source													

CAPITAL BUDGET BY ACTIVITY TYPE (000's)

REVISED BUDGET (IF APPROVED)	Activity Type	Prior Years	2022	2023	2024	2025	2026	2027	2028	2029	2030	Beyond 2030	Total
	Construction		-	-	23,000	24,000	22,000	-	-	-	-	-	-
Total		-	-	23,000	24,000	22,000	-	-	-	-	-	-	69,000

OPERATING IMPACT OF CAPITAL

Type of Impact:

Branch:	2025				2026				2027				2028			
	Rev	Exp	Net	FTE	Rev	Exp	Net	FTE	Rev	Exp	Net	FTE	Rev	Exp	Net	FTE
Fleet and Facility Services	-	-	-	-	-	-	-	1.0	-	-	-	-	-	-	-	-
Parks and Roads Services	-	-	-	2.0	-	-	-	-	-	-	-	-	-	-	-	-
Total Operating Impact	-	-	-	2.0	-	-	-	1.0	-	-	-	-	-	-	-	-

CAPITAL PROFILE REPORT

PROFILE NAME: Sample Basic Profile			
PROFILE NUMBER: 12-34-5678			
BUDGET CYCLE: 2023-2026			
Project Number	Project Name	Description	Percentage Funded
230001	ABC Research Facility Renewal	This initiative will fund design and construction for the ABC Research Facility Renewal	100
230002	Site Concrete Rehabilitation	Rehabilitation of concrete as indicated in condition assessment.	100
230004	Eco Station Groundwater Wells	Installation of eco station groundwater monitoring wells to meet regulatory requirements	100
230005	Fire Protection Regulatory Upgrades	Upgrades required in accordance with fire safety standards	100



Waste Services Facilities, Infrastructure and Process Equipment - Composite

Capital Funding Request

City Operations | Waste Services

City of Edmonton

Capital Profile: CM-81-2047

Project Number: Various

Profile Owner: Krista Berezowski

Profile Sponsor: Denis Jubinville

Version #: 2.0

Date published: August 31, 2022

page intentionally left blank

TABLE OF CONTENTS

Change History	5
Document Approval	5
Indigenous Acknowledgement	6
Executive Summary	7
Waste Services Facilities, Infrastructure and Process Equipment Composite Upgrade/Renewal	7
Background	7
Problem / Opportunity	8
Current Situation	8
Initiative Description	9
Initiative Description	9
Urgency of Need	9
Anticipated Outcomes	9
Scope	10
Out of Scope	10
Critical Success Factors	10
Strategic Alignment	10
Context Analysis	12
Organizational Change Impact	13
Stakeholder Impact	13
Business and Operational Impact	14
Benefits / Costs	14
Tangible Benefits	14
Intangible Benefits	14
Costs	15
Assumptions	15
Resourcing	15
Key Risk(s) and Mitigation Strategy	16
Conclusion and Recommendations	16
Conclusion	16
Recommendations	16
Project Responsibility and Accountability	16
Implementation Approach	17
Review and Approval Process	18
Appendices	19

Appendix A: Asset Replacement Value based on 2021 Annual Infrastructure Inventory	20
Appendix B: Waste Services Internal Project Planning and Prioritization Process	22
Appendix C: List of Projects	23
Appendix D: Financial Analysis Summary	27

Change History

Version #	Date	Author	Description
1.0	08/05/22	Lena Aitken	First draft of the Capital Funding Request
2.0	08/17/22	Lena Aitken	Second draft of Capital Funding Request



SUBMITTED BY:

Version #	Submitter Name	Title	Submission Date
2.0	Lena Aitken	Senior Project Engineer	August 17, 2022

REVIEWED BY:

Version #	Reviewer Name and Title	Signature	Signing Date
2.0	Neil Kjelland Director, Sustainable Waste Processing	Neil Kjelland	Aug 22, 2022
2.0	Chris Fowler Director, Collections Services	Chris Fowler	8/17/22
2.0	Jodi Goebel Director, Business Integration	Jodi Goebel	Sept 11, 2022
2.0	Keith Knoblauch Operational Controller, Business Financial Analytics	Keith Knoblauch	Sep 09, 2022
2.0	Crystal Wood Communications Advisor	Crystal Wood	Aug 19, 2022

APPROVED BY:

Version #	Approver Name and Title	Signature	Signing Date
2.0	Krista Berezowski Director, Technical Services		Sept 12, 2022
2.0	Denis Jubinville Branch Manager, Waste Services		September 13, 2022

Indigenous Acknowledgement

Edmonton is located within Treaty 6 Territory and within the Métis homelands and Métis Nation of Alberta Region 4. We acknowledge this land as the traditional territories of many First Nations such as the Nehiyaw (Cree), Denesuliné (Dene), Nakota Sioux (Stoney), Anishinaabe (Saulteaux) and Niitsitapi (Blackfoot).

The City of Edmonton owes its strength and vibrancy to these lands and the diverse Indigenous peoples whose ancestors' footsteps have marked this territory as well as settlers from around the world who continue to be welcomed here and call Edmonton home.

Together we call upon all our collective honoured traditions and spirits to work in building a great city for today and future generations.



1. Executive Summary

1.1. Waste Services Facilities, Infrastructure and Process Equipment Composite Upgrade/Renewal

Composite Profile CM-81-2047 provides capital funding for capital renewal, upgrade, and improvement projects for Waste Services valued at less than \$5 million. Waste Services assets include a number of facilities such as Eco Stations, employee workspaces, equipment facilities, administration buildings, waste processing facilities, and research and development facilities. These facilities contain heating, cooling, ventilation, fire protection systems, plumbing, electrical distribution, and other building systems. In addition to these systems, Waste Services owns and operates a series of specialized waste processing equipment required to meet the branch mandate of efficient and environmentally sound waste management operations. Waste Services also manages a variety of infrastructure including roads, drainage, and buried utilities for operating industrial processes at the Edmonton Waste Management Centre (EWMC) and other locations in the city.

To deliver sustainable waste management services, maintain optimal service levels, and have a sustainable and efficient asset management program, capital funds are required to carry out capital renewal, growth, modifications, improvements, and upgrades of Waste Services assets. This will result in safer and more reliable assets while maintaining high levels of customer service. Without this funding in place, facilities, process equipment, and infrastructure will be at increased risk of failure as the waste collection and processing systems age. Emergency situations caused by unforeseen failures can result in expensive unplanned repairs, safety issues for staff and public, and interruption to operations.

Waste Services manages these renewal and growth projects in collaboration with its partners such as Integrated Infrastructure Services (IIS), Fleet and Facility Services, and operation and maintenance contractors. This profile contains projects that have high integration with plant operations, are specific to waste processing, or are smaller than the IIS project thresholds, and therefore can be managed effectively by Waste Services. This requires funding of approximately \$19.4 million between 2023 and 2026.

To ensure adequate levels of funding are available for this capital profile, Waste Services has adopted a planning and prioritization approach that builds on understanding project drivers (need) and criticality (risk), which is closely aligned with the City's Corporate Risk-based Infrastructure Management System (RIMS) and Capital Budgeting Framework¹. This approach informs overall required capital investment in the improvement, renewal, and upgrade of the aforementioned assets, and is combined with the implementation of formalized asset condition assessment, preventative maintenance programs, safety and environmental improvements, and process improvement needs.

2. Background

Waste Services has an extensive infrastructure inventory which include facilities such as Eco

¹ Overview of the Budget Planning Processes, August 11, 2021, Budget Planning and Development, Financial and Corporate Services

Stations, employee workspaces, equipment facilities, administration buildings, waste processing facilities, and research and development facilities. These facilities contain mechanical, electrical, fire protection, other building systems, and specialized equipment. Infrastructure includes the Edmonton Waste Management Centre and Kennedale site utilities, roadways, drainage, communications, transaction data collection hardware and software, and specialized systems like odour monitoring.

The asset condition, functionality, expected life cycle, replacement value and other information are updated and tracked in the Corporate Risk-based Infrastructure Management System (RIMS). RIMS is a tool used to assist in ranking rehabilitation needs and allocation of renewal funds across various infrastructure assets to ensure long-term value. RIMS provides information on replacement value, average age, life expectancy and condition of City of Edmonton assets including those of Waste Services.

As of December 2021, the replacement value of Waste Services assets, captured through the Annual Infrastructure Inventory, is about \$369 million. (Appendix A - Asset Replacement Values). These assets require regular maintenance, upgrade, renewal, or modification for various reasons such as environmental compliance, safety enhancement, asset renewal/upgrade, process improvement, and strategic and business needs.

Throughout the 2023 - 2026 capital budget cycle, Waste Services will continue to assess asset conditions and criticality, and will implement capital projects to maintain the integrity and efficiency of the system. In addition, the planned projects will allow Waste Services to comply with regulatory requirements and audit recommendations, enhance industrial process safety, and manage its operations to meet the goals of Edmonton's 25-year Waste Strategy.

2.1. Problem / Opportunity

As Waste Services focuses on managing its assets effectively, the Utility has adopted a proactive approach to sustaining its facilities and infrastructure. This ensures that assets will be well maintained during their useful life and plans for rehabilitation, replacement, and upgrading, resulting in an overall improvement in collection and processing efficiencies while reducing life cycle costs. Projects included in this composite profile address a number of Waste Services business needs such as renewal of assets that have reached the end of their useful life, mitigation and elimination of safety and environmental risks and opportunities for continuous improvement.

2.2. Current Situation

Waste Services has implemented proactive and integrated processes for optimizing the value of its fixed assets. These processes reflect internationally recognized asset management standards and practices. Forming a dedicated Asset Management team was a crucial step Waste Services took to solidify this transformation. The goal of this team is to ensure the business' fixed and mobile assets are safe and reliable while providing optimum value to the organization. Tactically, this has been accomplished through updating the business' asset registers followed by analyzing assets' functions and risk profiles to arrive at appropriate maintenance, upgrading, and renewal programming. Projects are proposed based on data and information derived from this process.

To facilitate appropriate project vetting and approval, Waste Services implemented a Branch-wide project initiation, evaluation, prioritization and decision making process. This process identifies and ranks projects based on strategic criteria such as environmental impact, health and safety, and alignment to strategy. Current and future projects can be prioritized, managed and recommended for funding to align with branch and corporate goals, legislation, market demands and customer expectations.

3. Initiative Description

3.1. Initiative Description

The Waste Services Facilities, Infrastructure, and Process Equipment composite profile includes assessment of asset conditions and criticality, and proposes to implement capital projects prioritized to maintain the integrity and efficiency of the system. In addition, the planned projects will allow Waste Services to comply with regulatory requirements, enhance industrial process safety, and manage its operations to meet the goals of Edmonton’s 25-year Waste Strategy. The projects planned under this profile are relatively low value, multidisciplinary in nature, primarily industrial focused, and have high integration with plant operations, and therefore will be primarily managed through internal Waste Services engineering consultants, operation and maintenance contractors. Appendix C - List of Projects, shows the projects included in this profile.

3.2. Urgency of Need

During the initial planning process, a robust prioritization methodology was developed by Waste Services that aligns with corporate prioritization methods. The projects identified as critical or very important that cannot be deferred are included in this budget cycle. The risk of deferring these projects include potential asset and system failure, greater fire and safety risks, environmental noncompliance and inability to meet corporate and branch goals (such as diversion).

3.3. Anticipated Outcomes

The anticipated outcome of implementing the proposed projects includes asset integrity, system reliability, efficiency, enhanced safety and regulatory compliance:

Outcome /Deliverables
Better information to make capital investment decisions: Through a structured and integrated process, administration will ensure that projects identified as priorities by Waste Services receive robust evaluation of alternatives and scope identification. This will ensure stable utility rates.
Improved project schedule and budget estimates: Following City and industry best practices, a control budget and schedule is established on the basis of a completed design to ensure realistic expectations that are aligned with the Waste Services Project Management Framework prior to tendering and construction. The Waste Services Project Management Framework aligns with the IIS processes to ensure projects provide value-for-money and

demonstrate sound stewardship
Reliable facilities and infrastructure that enable sustainable waste management in a cost-effective manner.
High levels of customer service are delivered in both efficient and effective ways through leading-edge waste processing facilities that use current and emergent technology to enable high rates of diversion of waste from landfill.

3.4. Scope

The scope of this profile encompasses capital renewal and upgrade work for Waste Services facilities, process equipment, and infrastructure. This includes, but is not limited to, site improvements, new process equipment, changes in existing facilities and infrastructure, upgrades to building systems, and upgrades to the current transaction data collection systems.

3.5. Out of Scope

- Renewal projects exceeding \$5 million or growth projects over \$2 million are out of scope for this capital funding request. Any projects with a total budget that exceed these corporate thresholds are included within the Waste Services IIS managed profiles.
- Operational repair and maintenance activities.
- Vehicles and equipment. These are included in a separate capital funding request.
- Projects to be managed by Integrated Infrastructure Services.

3.6. Critical Success Factors

Critical success factors include:

- Adherence to asset management and project management frameworks.
- Proper design and documentation, following the corporate engineering practice guidelines.
- Timely execution of projects.
- Proper quality control, functional tests, and commissioning.
- Accurate and sufficient data and cost analyses to support high level budget estimates and informed decision making for the projects.
- Regular check-ins with Waste Services Leadership Team to ensure alignment with strategic direction, City and branch goals.

4. Strategic Alignment

Waste Services is committed to advancing Council's vision and goals. This capital funding request contributes to the overall strategic direction of City Council and goals of policies and corporate strategic documents listed in the table below. This contribution is made by demonstrating leadership in waste management and processing standards, and by increasing diversion of residential and non-residential waste from landfill.

<p>City of Edmonton Environmental Policy C512²</p>	<p>The policy states that “The City of Edmonton, through its planning, decision-making processes, and leadership, will promote the development of an environmentally sustainable community that functions in harmony with the natural environment.</p> <p>The City of Edmonton will exercise environmental stewardship of its operations, products and services, based on its commitment to:</p> <ul style="list-style-type: none"> ● prevent pollution; ● continually improve its environmental performance by setting and reviewing environmental objectives and targets; and ● meet or exceed applicable environmental legal requirements and other requirements to which it subscribes.”
<p>ConnectEdmonton: Vision 2050³</p>	<p>This profile aligns with the City’s Vision 2050 strategic plan by ensuring that waste is collected efficiently, processed responsibly, and the amount landfilled is minimized, Edmonton will be a healthy city, urban places will be clean, regional prosperity is increased by building a circular economy, and a low-carbon future is assured.</p>
<p>Waste Services Business Plan 2022-2025⁴</p>	<p>The Business Plan outlines how Waste Services will continue to make transformational impacts through the 25-year Waste Strategy, provide essential services to Edmontonians while maintaining full cost recovery, and improve employee and resident experience to support adaptation of new systems.</p>
<p>25-Year Waste Strategy⁵</p>	<p>Using a Zero Waste Framework, the strategy affirms Waste Services’ commitment to 90 per cent diversion of single unit residential waste from landfill. It also brings Edmonton into alignment with internationally-recognized best practices, emphasizing waste prevention and waste reduction, while redesigning services to help all Edmontonians more easily take part in Edmonton’s zero waste future.</p>

² COE Environmental Policy C512

³ ConnectEdmonton

⁴ Waste Services Business Plan 2022-2025

⁵ 25-Year Waste Strategy

Waste Services Utility Fiscal Policy C558B ⁶	<p>The purpose of this policy is to:</p> <ul style="list-style-type: none"> ● Ensure the Waste Services Utility is operated in a manner that reflects City Council’s overall vision and philosophical objectives for the Utility. ● Ensure there is a consistent approach year over year for the financial planning, budgeting, and rate setting for the City managed Utility. ● Ensure the Utility is financially sustainable over the long term.
Capital Project Governance Policy C591 ⁷	<p>Policy C591 stated the City of Edmonton is committed to achieving effective and efficient use of public funds dedicated to capital projects.</p> <p>The Waste Services Project Management Framework was developed to provide guidance and standard processes for project management practices Waste Services uses.</p> <p>The framework aligns with corporate processes outlined in Policy C591, ensuring projects provide value-for-money and demonstrate sound stewardship.</p>

5. Context Analysis

Waste Services has adopted the planning and prioritization approach that builds on understanding project drivers (need) and criticality (risk), which is closely aligned with the City’s RIMS and Capital Budgeting Framework⁸. This approach informs overall required capital investment in improvement, renewal, and upgrade of the aforementioned assets, and is combined with implementation of formalized asset condition assessments, preventative maintenance programs, safety and environmental improvements, and process improvement needs. Projects are scored based on Project Driver and Criticality, and are prioritized based on total score (Project driver score * criticality score). Projects that are critical and cannot be deferred to the next budget cycle were prioritized to be initiated this budget cycle.

The annual cash flow projections between 2023-2026 were calculated based on high level cost estimates of each individual project, on the basis of previous project costs, and on experience and judgment. Total annual projections were then checked and validated against the percentage of total asset replacement value and were found to be reasonable.

As of December 2021, Waste Services assets were valued at approximately \$369 million, excluding vehicles and equipment (Appendix A). For this budget period, the average annual

⁶ Waste Services Utility Fiscal Policy C558B

⁷ Capital Project Governance Policy C591

⁸ Overview of the Budget Planning Processes, August 11, 2021, Budget Planning and Development, Financial and Corporate Services

funding request for this profile is approximately 1.3% of asset replacement value. In addition, capital projects will also be managed through Integrated Infrastructure Services composite profiles. The combined annual funding request for both profiles is approximately 3.1% of asset value.

A list of required projects was collected from operational areas, including project scope, schedule, risks and estimates. These were evaluated, ranked and prioritized based on strategic and operational criteria, i.e., Project Driver and Project Criticality as outlined in the Waste Services Internal Project Planning and Prioritization Process (Appendix B).

Projects include a variety of process and facility improvements, site improvements, and EWMC site fire protection. Appendix C - List of Projects, shows the projects included in this profile.

Project costs used for requesting and evaluating the projects are high level estimates and will be reviewed and validated through bi-annual re-prioritization exercises for possible adjustments according to Branch priority. Planning, documentation, and approval processes for each individual project follows the approved [Waste Services Project Management Framework](#).

6. Organizational Change Impact

6.1. Stakeholder Impact

Stakeholder Impact
Stakeholder 1: City of Edmonton Waste Services Branch (primary internal)
Minimal impact to staff once upgrades of facilities and infrastructure are ongoing (e.g. relocation during construction/installation)
Stakeholder 2: City Council (primary internal)
Robust capital planning and reporting to enable effective oversight and demonstrate continued alignment to Council Policies and the strategic goals of Edmonton's 25-Year Waste Strategy
Stakeholder 3: Residents (primary external)
Effective and efficient asset management that demonstrates value and enables continued service and utility rate stability.
Stakeholder 4: Contractors within Waste Services facilities (primary external)
Minimal disruption to operations due to construction/installation.
Stakeholder 5: Customers dropping off materials at Waste Services facilities (secondary external)
Strategies to mitigate inconvenience using facilities when dropping off materials.

6.2. Business and Operational Impact

Business & Operational Impact & Description
Human Resources: Waste Services (internal)
Resources and organizational structure will be reviewed to ensure effective delivery of program
Procurement: Corporate Procurement and Supply Services (internal)
Increase in resource demand to provide procurement support
Legal Support: Law Branch (internal)
May require additional resources for legal support, review of contract for non-standard contract terms and conditions as well as review of documents to support procurement for numerous low-value projects

Moving forward, the City of Edmonton is committed to the use of Gender-Based Analysis Plus (GBA+). Waste Services will identify root causes on any issues that may arise, use an evaluation approach, consider inputs from affected stakeholders (e.g. people with disabilities, indigenous people, seniors, etc.), and develop and implement an action plan for safety, diversity and inclusivity issues using GBA+. Waste Services acknowledges that GBA+ is an equity assessment tool that allows for holistic consideration of the need for use, and impact of, this capital funding request and that staff are trained in the GBA+ process.

7. Benefits / Costs

7.1. Tangible Benefits

The following are the tangible benefits of managing assets in a more proactive and integrated way:

- Improved operational efficiency of facilities, infrastructure and process equipment.
- Reduction in safety-related incidents.
- Long term savings due to reduction in repair costs.
- Improved productivity due to better access to facilities and equipment, and increased availability due to reduced down time.

7.2. Intangible Benefits

The following are the intangible benefits of managing assets in a more proactive and integrated manner:

- Increased employee morale due to better working conditions.
- Safer working environment for staff and customers.
- Increased or maintained customer satisfaction.

7.3. Costs

Basis for Calculation of Costs for 2023-2026

Year	2023	2024	2025	2026	2023-2026 Total
Profile Cost (CM-81-2047 - Design and Delivery*)	\$4,234,731	\$6,787,824	\$5,275,075	\$3,111,032	\$19,408,662
% of Replacement Value**	1.14%	1.84%	1.43%	0.84%	1.32%

* This profile combines the design and delivery of proposed projects. Because of the nature of the projects under this profile, the majority of the projects will be managed by Waste Services through internal stakeholders such as Facility Maintenance Services, and Facility Operations and Maintenance contractors.

** Percent is based on the 2021 Annual Infrastructure Inventory value of \$368.8 million as shown in Appendix A.

Refer to the Financial Analysis Summary⁹ and 2023-2026 Waste Services Capital Planning¹⁰ for details.

7.4. Assumptions

- Project estimates are considered Class 5 and are based on conceptual plans with limited information. The accuracy of estimates are within a range of -30% to +50%.¹¹
- Pricing may be impacted by the market.
- Asset replacement cost of \$368,798,084 (value as of December 2021) was used for the budget period.

8. Resourcing

The projects will be led internally by Waste Services project managers, in collaboration with partners such as Integrated Infrastructure Services, Fleet and Facility Services, operational sections, and operations and maintenance contractors. Waste Services will use corporate processes, such as corporate procurement methods, to complete the design and construction phases.

9. Key Risk(s) and Mitigation Strategy

Risks	Impact	Mitigation Strategy
-------	--------	---------------------

⁹ Financial Analysis Summary

¹⁰ 2023-26 Waste Services Capital Planning

¹¹ Facility Design & Construction

Global supply chain issue for specialized equipment.	High	Use locally available materials and equipment to specification if possible. Allow sufficient time for equipment supply lead time.
Health and safety issues if numerous small value projects are not implemented on time.	Medium	Prioritize projects and ensure timely implementation.
Changes in processing equipment brought about by future waste initiatives to increase diversion rate.	Medium	Develop asset management strategic plan incorporating required process equipment to address future waste initiatives.

10. Conclusion and Recommendations

10.1. Conclusion

This profile will provide capital funding for capital renewal, upgrade, and improvement projects for Waste Services valued at less than \$5 million. This funding will ensure assets provide overall improvement in operating efficiency, effectiveness, safe working conditions and meet environmental compliance. The total funding requested for 2023-2026 is approximately \$19.4 million.

10.2. Recommendations

It is recommended this profile be approved to assist Waste Services to meet its commitment to deliver integrated and sustainable waste management services. This will ensure capital renewal and upgrade of assets to address safety concerns, meet environmental compliance and improve operating efficiency.

10.3. Project Responsibility and Accountability

The individual projects within this profile will be led by Waste Services Project Managers, who will be assigned based on their experience and knowledge. They will coordinate with General Supervisors of the respective facilities and infrastructure, operating and maintenance groups, Occupational Health and Safety coordinators, and other stakeholders.

The Project Sponsor is the Branch Manager of Waste Services. The overall capital program is managed by the Director of Technical Services, in collaboration with Sustainable Waste Processing Services, Collection Services, Business Integration, and Financial Services.

11. Implementation Approach

As opportunities for improvement or production issues are identified, assigned project managers for the facilities, infrastructure or system review and develop options for solutions. These are reviewed with operating and maintenance groups and Occupational Health and Safety to determine the most cost effective solution that will resolve the issue.

Solution requirements are incorporated into a public tender. Tenders are evaluated by engineering, operations, and maintenance personnel to choose a vendor that meets the conditions of the tender.

12. Review and Approval Process

The following review and approval process was followed for this capital funding request:

Review Step	Reviewer
Review 1	Team Lead of Technical Services, General Supervisor of Business Integration, General Supervisor of Collection Services, General Supervisors of Sustainable Waste Processing, General Supervisors of Technical Services, and Senior Accountant of Financial Services.
Review 2	Director of Finance, Director of Business Integration, Director of Collection Services, Director of Sustainable Waste Processing, Director of Technical Services (Final Approver) and Senior Communications Advisor.
Review 3	Branch Manager of Waste Services (Final Approver)
Review 4	Utility Advisor
Review 5	Utility Committee report presented

13. Appendices

Appendix A - Asset Replacement Value based on 2021 Annual Infrastructure Inventory

Appendix B - Waste Services Internal Project Planning and Prioritization Process

Appendix C - List of Projects

Appendix D - Financial Analysis Summary

Appendix A: Waste Services Asset Replacement Values (as of 2021)**Waste Services Infrastructure and Facilities**

Assets	Replacement Value (in thousands)
Edmonton Waste Management Centre (EWMC)	
Environmental Facilities - Landfill Systems	
Secant Wall	\$1,254
Leachate Collection System	\$4,000
Leachate Storage and Transfer	\$2,900
Groundwater Diversion System	\$17,400
Monitoring Wells	\$700
EWMC Site Common	
Fences, Gates, Security	\$400
Open Space	\$2,800
Parking Lots	\$1,660
Roads	\$4,700
Site Equipment	\$3,331
Utilities	\$5,277
Waste Processing	
Anaerobic Digestion Facility	\$65,500
Construction and Demolition Facility	\$5,150
Cure Site	\$21,300
Integrated Processing and Transfer Facility	\$70,709
Materials Recycling Facility	\$20,870
Research and Development Equipment	
Buildings	
Waste Mgmt Control Centre/Admin (Site #100)	\$2,359
Waste Mgmt Main Weigh Scales (Site #200)	\$211
Waste Mgmt Operations Centre (Site #300)	\$2,072
Waste Mgmt Research & Development (Site #310)	\$8,821

Miscellaneous Structures (i.e. trailers, quonsets)	\$1,579
Waste Mgmt IPTF Admin Building (Site #480)	\$3,756
Waste Mgmt Advanced Energy Res. Fac. (Site #306)	\$3,776
Waste Mgmt Equip. Storage & Maint. Facility (#320)	\$11,104
Waste Mgmt Facility (Site #440)	\$19,615
Waste Mgmt Composter Admin Building (Site #500)	\$3,077
Total EWMC Replacement Value	\$295,323
Collections Services	
Ambleside Eco Station	\$7,669
Ambleside Reuse Centre	\$1,378
Ambleside Eco Station Kiosks	\$115
Coronation Eco Station	\$2,361
Strathcona Eco Station	\$6,167
Eco Station Storage Garage	\$2,202
Kennedale Waste Admin Building	\$5,790
Kennedale Waste Transfer Station	\$7,748
Kennedale Waste Operations	\$10,830
Kennedale Waste Operations Bldg East	\$22,609
Kennedale Eco Station	\$5,694
Kennedale Reuse Building	\$913
Total Collections Replacement Value	\$73,475
Total EWMC and Collections Services Replacement Value	\$368,798

Source: 2021 Risk-based Infrastructure Management System (RIMS); 2021 Tririga Data

APPENDIX B: Waste Services Internal Project Planning and Prioritization Process

The following outlines the Project Prioritization process:

1. Capital project needs are identified from all sections of the Utility and listed on the [2023-26 Waste Services Capital Planning Sheet](#).
2. Each project is scored based on the Project Driver and the Project Criticality. See tables 1 and 2 below for details. Total project score for each project is calculated by multiplying the driver and criticality scores.
3. Projects are then prioritized based on the total scores.
4. Projects are recommended based on prioritization with budget estimates.
5. Waste Services Leadership Team (WSLT) reviews and approves the final list.
6. Planning, documentation, and approval process for each individual project follows the approved Waste Services Project Management Framework.
7. Re-prioritization exercises occur on a bi-annual basis for possible adjustments according to Branch priority.

Table 1: Project Driver

Project Driver (score)						
Regulatory / Compliance (5)	Safety / Environmental Enhancement (5)	Asset Renewal/ Upgrade (4)	Business Need / Growth (3)	Strategic / Corporate Goal (3)	Process / Operational Improvement (3)	Other (3)

Table 2: Project Criticality

Project Criticality (score)		
Critical - cannot be deferred (3)	Very Important - cannot be deferred (2)	Can be deferred (1)

Appendix C: List of Projects

The following table shows projects anticipated to be undertaken for this budget cycle:

Project	Description	Project Driver / Objective
Anaerobic Digestion Facility (ADF) Wet Scrubber / Biofilter Plenum Reconfiguration	Upgrade the wet scrubber/biofilters in order to adequately remove ammonia. Examine the legacy ECF infrastructure for ADF suitability.	Meet regulatory requirements
ADF COCCUS/T6 connection	Adding piping infrastructure to connect ADF coccus to T6 to allow for efficient percolate draining.	Process / Operational Improvements: Operational cost savings
ADF Control Room Upgrades	Upgrades to control room HVAC and interior finish.	Safety and environmental enhancement
ADF Fermenter instrumentation and sample ports	Adding flow meters to each fermenter for biogas monitoring.	Process / Operational Improvements
ADF H ₂ S Scrubber	Addition of H ₂ S scrubbers required for CHP operation.	Strategic / Corporate goal
ADF Miscellaneous Platforms	Install permanent access platform(s) for more efficient operations and maintenance activities and generate as-built drawings.	Process / Operational Improvements
ADF Percolate System Upgrades	Twinning the piping and/or lift station to enhance percolate system reliability.	Business need / Growth
ADF Probe Insertion Aid	Design and construct a mechanical aid to assist lifting and inserting probe.	Safety and environmental enhancement
ADF Pump House Ventilation	Improvements to pump house ventilation to reduce heat.	Safety and environmental enhancement
ADF Shutdown Rehab	Capital upgrades to be executed during the planned ADF shutdown.	Process / Operational Improvements
ADF to Materials Recovery Facility (MRF) Electrical Connection	Electrically connect the CHPs to the MRF to supply power.	Strategic / Corporate Goal
Advanced Energy Research Facility (AERF) - Renewals	Facility rehabilitation/renewal projects identified from building condition assessment reports	Asset Renewal/Upgrade: Extend the asset's service life, reduce energy cost and GHG emissions
Collections - Digitization of trucks	Tablets for collection vehicles operational needs (i.e. inspections, timesheets, vehicle defect forms, etc)	Process / Operational Improvements
Collections - Posse for workflow	Transitioning notification orders from paper to electronic entry using Posse.	Business need / Growth

Coronation Eco Station - 22-81-2055 - Concept planning	Concept planning for Coronation Eco Station expansion	Business need / Growth
Coronation Eco Station - Renewals	Facility rehabilitation/renewal projects identified from building condition assessment reports	Asset Renewal/Upgrade: Extend the asset's service life, reduce energy cost and GHG emissions
Coronation Eco station - Groundwater Wells	Installation of nine groundwater wells for environmental monitoring.	Meet regulatory requirements
Cure Site - Tarp Winders Replacement	Replacing the tarp winders at the Gore Site due to end-of-life.	Process / Operational Improvements
Cure Site Concrete Rehab	Rehabilitation of concrete as indicated in condition assessment.	Process / Operational Improvements: Infrastructure improvement
Eco Station Storage Garage - Renewals	Facility rehabilitation/renewal projects identified from building condition assessment reports	Asset Renewal/Upgrade: Extend the asset's service life, reduce energy cost and GHG emissions
EWMC - Groundwater Wells	Abandonment and installation of groundwater monitoring wells at EWMC	Meet regulatory requirements
EWMC - Geoware Upgrades	Upgrade and enhance weigh scale data collection program	Process/Operational Improvement: System requirement
EWMC - SCADA Servers Replacement	SCADA server upgrades due to the age of the equipment. This will improve relative performance, consolidation, management efficiency and reliability	Process / Operational Improvements
Integrated Process and Transfer Facility (IPTF) - Electrical instrumentation and control upgrades	Electrical instrumentation and control upgrades due to age of equipment.	Process / Operational Improvements
IPTF - HVAC Renewal	Upgrades and/or replacement of HVAC units due to inefficient operation.	Asset Renewal/Upgrade: Extend the asset's service life, reduce energy cost and GHG emissions
IPTF - Pre-processing Vacuum Engineering and Piping	Design and delivery of a vacuum system for the pre-processing area.	Process / Operational Improvements
IPTF Grizzly Replacements	Replacement of two Grizzly units due to end of life.	Asset Renewal/Upgrade: Extend the asset's service life, reduce energy cost and GHG emissions
IPTF Lifting Devices over Trommel Trunnions	Design and deliver permanent devices over IPTF trommels for future maintenance and replacement needs.	Asset Renewal/Upgrade: Extend the asset's service life, reduce energy cost and GHG emissions
Kennedale East / West locker room expansion	Locker room expansion to accommodate space requirements	Business Need / Growth
Kennedale Eco Station -	Installation of nine groundwater wells for	Meet regulatory requirements

Groundwater Wells	environmental monitoring.	
Kennedale Waste Admin - Roof Replacement	Facility rehabilitation/renewal projects identified from building condition assessment reports	Asset Renewal/Upgrade: Extend the asset's service life, reduce energy cost and GHG emissions
Kennedale Waste Operations - Renewals	Facility rehabilitation/renewal projects identified from building condition assessment reports	Asset Renewal/Upgrade: Extend the asset's service life, reduce energy cost and GHG emissions
Kennedale Waste Transfer Station - Renewals	Facility rehabilitation/renewal projects identified from building condition assessment reports	Asset Renewal/Upgrade: Extend the asset's service life, reduce energy cost and GHG emissions
MRF Infrastructure Rehab	Facility rehabilitation/renewal projects identified from building condition assessment reports	Asset Renewal/Upgrade: Extend the asset's service life, reduce energy cost and GHG emissions
North Saskatchewan River erosion control	North Saskatchewan River bank stabilization to prevent erosion adjacent to the Clover Bar Landfill.	Safety/Environmental Enhancement
Clover bar landfill - Cutoff wall	Slurry wall project to block leachate seepage from the Clover Bar landfill into the North Saskatchewan River	Environmental Enhancement
Operations Building - Renewals	Facility rehabilitation/renewal projects identified from building condition assessment reports	Asset Renewal/Upgrade: Extend the asset's service life, reduce energy cost and GHG emissions
Organics - Addition of Geoware to Conveyor Scale	Add Geoware connection to the conveyor scale to provide automation	Process / Operational Improvements
Organics Tip Floor Drainage Enhancement	Upgrades to the tip floor drainage to accommodate the SSO burden.	Process / Operational Improvements
Organics Tip Floor Source Capture (Dust)	Design and construct a dust collection system.	Process / Operational Improvements
Organics - IPTF to ADF Conveyor Extension	Conveyor system extension to reduce double handling of material with loaders.	Process / Operational Improvements
Organics/ADF - Electrical instrumentation and control upgrades	Electrical instrumentation and control upgrades.	Process / Operational Improvements
Refuse Derived Fuel (RDF) - 25 KV switchgear replacement	Decommission of the 25 KV switchgear and replace with EPCOR transformer to increase reliability	Process / Operational Improvements
RDF - 2nd Floor Awning	Install an awning over the 2nd floor that leads from the main RDF building to the load out building.	Safety/Environmental Enhancement
RDF - Electrical instrumentation and control upgrades	Electrical instrumentation and control upgrades due to age of equipment.	Process / Operational Improvements

RDF - MCC Room Positive Pressure	Design and installation of a system to create a positive pressure environment in the MCC room.	Asset Renewal/Upgrade: Extend the asset's service life, reduce energy cost and GHG emissions
RDF - Dryer Distribution Screws Maintenance Access	Structural modifications to perform maintenance on dryer distribution screws.	Asset Renewal/Upgrade: Extend the asset's service life, reduce energy cost and GHG emissions
RDF - Spare motor for Pre-shredder	Purchase of spare motor for pre-shredder (critical spare part)	Asset Renewal/Upgrade: Extend the asset's service life, reduce energy cost and GHG emissions
RDF Boiler Improvement	Improvements to the RDF boiler for emission reduction.	Safety / Environmental Enhancement
RDF Dust Collection Improvements	Phase 2 improvements to increase effectiveness of dust collection, as recommended by specialists.	Process / Operational Improvements
RDF Fire Protection Regulatory Upgrades	Upgrades required in accordance with fire safety standards.	Safety / Environmental Enhancement
RDF Vacuum	Design and delivery of a vacuum system for the RDF area.	Process / Operational Improvements

Projects will be reviewed and validated through bi-annual re-prioritization exercises for possible adjustments according to Branch priority.

Appendix D: Financial Analysis Summary¹²

Project Title:Waste Services Infrastructure, Facilities, and Process Equipment	Build Infrastructure Through Capital Funding
Total Capital Cost	(\$19,408,662)
Total Revenues	\$0
Total Operating and Maintenance Costs	(\$4,378,143)
Total Lease Costs	\$0
Project Net Inflows (Outflows)	(\$23,786,805)
WACC Discount Rate	6.28%
Project Cost (Present Value)	(\$18,038,879)

The following table and graph demonstrate the cumulative present value of the revenues that must be realized through annual rate collection to support the project costs. This includes operating and maintenance costs, interest and amortization expenses over the project lifecycle.

¹²Waste Services Infrastructure, Facilities and Process Improvement Financial Analysis

Infrastructure, Facilities, and Process Equipment Cumulative Present Value of Revenue Requirement

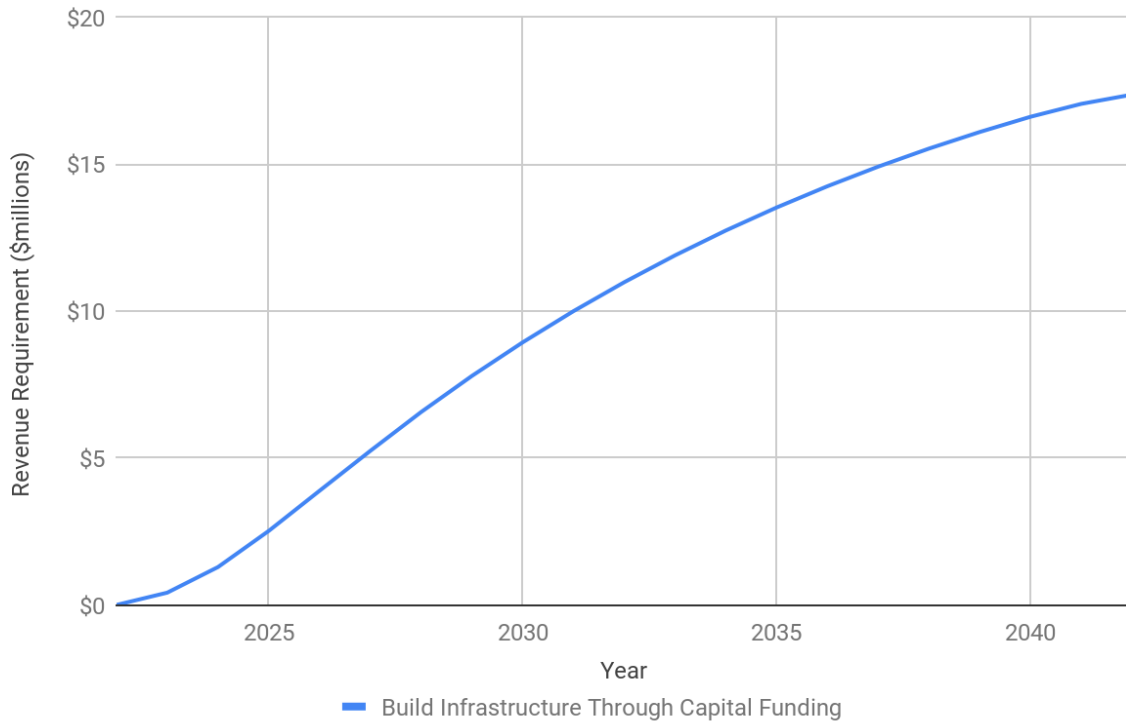

Year	Calendar Year	Build Infrastructure Through Capital Funding
0	2022	\$0
1	2023	\$417,577
2	2024	\$1,289,656
3	2025	\$2,520,451
4	2026	\$3,885,860
5	2027	\$5,243,449
6	2028	\$6,563,761
7	2029	\$7,792,403
8	2030	\$8,934,828
9	2031	\$9,996,169
10	2032	\$10,981,262
11	2033	\$11,894,655
12	2034	\$12,740,632
13	2035	\$13,523,228
14	2036	\$14,246,239
15	2037	\$14,913,239

16	2038	\$15,527,594
17	2039	\$16,092,473
18	2040	\$16,610,859
19	2041	\$17,050,354
20	2042	\$17,365,448
21	2043	\$0
22	2044	\$0
23	2045	\$0
24	2046	\$0
25	2047	\$0

CAPITAL PROFILE REPORT

PROFILE NAME:	WASTE SERVICES FACILITIES, INFRASTRUCTURE AND PROCESS EQUIPMENT	RECOMMENDED FUNDED
PROFILE NUMBER:	CM-81-2047	PROFILE STAGE: Approved
DEPARTMENT:	Utilities	PROFILE TYPE: Composite
LEAD BRANCH:	Waste Services	LEAD MANAGER: Denis Jubinville
PARTNER:		PARTNER MANAGER:
BUDGET CYCLE:	2023-2026	ESTIMATED START: January, 2023
		ESTIMATED COMPLETION: December, 2026

Service Category: Utilities		Major Initiative:	
GROWTH	RENEWAL	PREVIOUSLY APPROVED:	-
50	50	BUDGET REQUEST:	19,409
		TOTAL PROFILE BUDGET:	19,409

PROFILE DESCRIPTION

Composite Profile CM-81-2047 provides capital funding for capital renewal, upgrade, and improvement projects for Waste Services valued at less than \$5 million. Waste Services assets include a number of facilities such as Eco Stations, employee workspaces, equipment facilities, administration buildings, waste processing facilities, and research and development facilities. These facilities contain heating, cooling, ventilation, fire protection systems, plumbing, electrical distribution, and other building systems. In addition to these systems, Waste Services owns and operates a series of specialized waste processing equipment required to meet the branch mandate of efficient and environmentally sound waste management operations. Waste Services also manages a variety of infrastructure including roads, drainage, and buried utilities for operating industrial processes at the Edmonton Waste Management Centre (EWMC) and other locations in the city.

To deliver sustainable waste management services, maintain optimal service levels, and have a sustainable and efficient asset management program, capital funds are required to carry out capital renewal, growth, modifications, improvements, and upgrades of Waste Services assets. This will result in safer and more reliable assets while maintaining high levels of customer service. Without this funding in place, facilities, process equipment, and infrastructure will be at increased risk of failure as the waste collection and processing systems age. Emergency situations caused by unforeseen failures can result in expensive unplanned repairs, safety issues for staff and public, and interruption to operations.

Waste Services manages these renewal and growth projects in collaboration with its partners such as Integrated Infrastructure Services (IIS), Fleet and Facility Services, and operation and maintenance contractors. This profile contains projects that have high integration with plant operations, are specific to waste processing, or are smaller than the IIS project thresholds, and therefore can be managed effectively by Waste Services. This requires funding of approximately \$19.4 million between 2023 and 2026.

To ensure adequate levels of funding are available for this capital profile, Waste Services has adopted a planning and prioritization approach that builds on understanding project drivers (need) and criticality (risk), which is closely aligned with the City's Corporate Risk-based Infrastructure Management System (RIMS) and Capital Budgeting Framework. This approach informs overall required capital investment in the improvement, renewal, and upgrade of the aforementioned assets, and is combined with the implementation of formalized asset condition assessment, preventative maintenance programs, safety and environmental improvements, and process improvement needs.

PROFILE BACKGROUND

Waste Services has an extensive infrastructure inventory which include facilities such as Eco Stations, employee workspaces, equipment facilities, administration buildings, waste processing facilities, and research and development facilities. These facilities contain mechanical, electrical, fire protection, other building systems, and specialized equipment. Infrastructure includes the Edmonton Waste Management Centre and Kennedale site utilities, roadways, drainage, communications, transaction data collection hardware and software, and specialized systems. As of December 2021, the replacement value of Waste Services assets, captured through the Annual Infrastructure Inventory, is about \$369 million. These assets require regular maintenance, upgrade, renewal, or modification for various reasons such as environmental compliance, safety enhancement, asset renewal/upgrade, process improvement, and strategic and business needs. Waste Services will continue to assess asset conditions and criticality, and will implement capital projects to maintain the integrity and efficiency of the system.

PROFILE JUSTIFICATION

This initiative will provide funding for maintenance, renewal, upgrades, and efficiency improvements for Waste Services facilities and infrastructure. The main factors are the age of the infrastructure and facilities, existing safety issues, increasing demand and needed improvements to increase operational efficiency and effectiveness.

Urgency of Need:

During the initial planning process, a robust prioritization methodology was developed by Waste Services that aligns with corporate prioritization methods. The projects identified as critical or very important that cannot be deferred are included in this budget cycle. The risk of deferring these projects include potential asset and system failure, greater fire and safety risks, environmental noncompliance and inability to meet corporate and branch goals (such as diversion).

Anticipated Outcome:

Better information to make capital investment decisions: Through a structured and integrated process, administration will ensure that projects identified as priorities by Waste Services receive robust evaluation of alternatives and scope identification. This will ensure stable utility rates.

Improved project schedule and budget estimates: Following City and industry best practices, a control budget and schedule is established on the basis of a completed design to ensure realistic expectations that are aligned with the Waste Services Project Management Framework prior to tendering and construction. The Waste Services Project Management Framework aligns with the IIS processes to ensure projects provide value-for-money and demonstrate sound stewardship.

Reliable facilities and infrastructure that enable sustainable waste management in a cost-effective manner.

High levels of customer service are delivered in both efficient and effective ways through leading-edge waste processing facilities that use current and emergent technology to enable high rates of diversion of waste from landfill.

STRATEGIC ALIGNMENT

This capital funding request contributes to the overall strategic direction of City Council and goals of policies and corporate strategic documents listed in the table below. This contribution is made by demonstrating leadership in waste management and processing standards, and by increasing diversion of waste from landfill.

City of Edmonton Environmental Policy C512

ConnectEdmonton: Vision 2050

Waste Services Business Plan 2022-2025

25 Year Waste Strategy

Waste Services Utility Fiscal Policy C558B

Capital Project Governance Policy C591

ALTERNATIVES CONSIDERED

This is a capital funding request and does not present any alternatives for consideration. This profile is taking a status quo approach (funding capital renewal/upgrade work as required) continuing from the 2019-2022 budget cycle business case.

COST BENEFITS

Tangible:

Improved operational efficiency of facilities, infrastructure and process equipment.

Reduction in safety-related incidents.

Long term savings due to reduction in repair costs.

Improved productivity due to better access to facilities and equipment, and increased availability due to reduced down time.

Intangible:

Increased employee morale due to better working conditions.

Safer working environment for staff and customers.

Increased or maintained customer satisfaction.

KEY RISKS & MITIGATING STRATEGY

Risk: Global supply chain issue for specialized equipment.

Mitigating Strategy: Use locally available materials and equipment to specification if possible. Allow sufficient time for equipment supply lead time.

Risk: Health and safety issues if numerous small value projects are not implemented on time.

Mitigating Strategy: Prioritize projects and ensure timely implementation.

Risk: Changes in processing equipment brought about by future waste initiatives to increase diversion rate.

Mitigating Strategy: Develop asset management strategic plan incorporating required process equipment to address future waste initiatives.

RESOURCES

The projects within this profile will be led by Waste Services Project Managers. They will coordinate with General Supervisors of the respective facilities and infrastructure, operating and maintenance groups, Occupational Health and Safety coordinators, and other stakeholders.

CONCLUSIONS AND RECOMMENDATIONS

Conclusion:

This profile will provide capital funding for capital renewal, upgrade, and improvement projects for Waste Services valued at less than \$5 million. This funding will ensure assets provide overall improvement in operating efficiency, effectiveness, safe working conditions and meet environmental compliance. The total funding requested for 2023-2026 is approximately \$19.4 million.

Recommendation:

It is recommended this profile be approved to assist Waste Services to meet its commitment to deliver integrated and sustainable waste management services. This will ensure capital renewal and upgrade of assets due to new or increased waste streams, safety concerns, and design improvements that increase efficiency of Waste Services' operations.

CAPITAL PROFILE REPORT

PROFILE NAME: **Waste Services Facilities, Infrastructure and Process Equipment** **RECOMMENDED FUNDED**
 PROFILE NUMBER: **CM-81-2047** PROFILE TYPE: **Composite**
 BRANCH: **Waste Services**

CAPITAL BUDGET AND FUNDING SOURCES (000's)

APPROVED BUDGET		Prior Years	2022	2023	2024	2025	2026	2027	2028	2029	2030	Beyond 2030	Total
	Approved Budget	Original Budget Approved	-	-	-	-	-	-	-	-	-	-	-
	Current Approved Budget	-	-	-	-	-	-	-	-	-	-	-	-

BUDGET REQUEST	Budget Request	-	-	4,235	6,788	5,275	3,111	-	-	-	-	-	19,409
	Revised Funding Sources (if approved)												
	Self-Liquidating Debentures	-	-	4,235	6,788	5,275	3,111	-	-	-	-	-	19,409
	Requested Funding Source	-	-	4,235	6,788	5,275	3,111	-	-	-	-	-	19,409

REVISED BUDGET (IF APPROVED)	Revised Budget (if Approved)	-	-	4,235	6,788	5,275	3,111	-	-	-	-	-	19,409
	Requested Funding Source												
	Self-Liquidating Debentures	-	-	4,235	6,788	5,275	3,111	-	-	-	-	-	19,409
	Requested Funding Source	-	-	4,235	6,788	5,275	3,111	-	-	-	-	-	19,409

CAPITAL BUDGET BY ACTIVITY TYPE (000's)

REVISED BUDGET (IF APPROVED)	Activity Type	Prior Years	2022	2023	2024	2025	2026	2027	2028	2029	2030	Beyond 2030	Total
		Construction	-	-	4,235	6,788	5,275	3,111	-	-	-	-	-
	Total	-	-	4,235	6,788	5,275	3,111	-	-	-	-	-	19,409

OPERATING IMPACT OF CAPITAL

Type of Impact:

Branch:																
	Rev	Exp	Net	FTE	Rev	Exp	Net	FTE	Rev	Exp	Net	FTE	Rev	Exp	Net	FTE
Total Operating Impact	-	-	-	-	-	-	-	-	-	-	-	-	-	-	-	-

CAPITAL PROFILE REPORT

PROFILE NAME: Waste Services Facilities, Infrastructure and Process Equipment			
PROFILE NUMBER: CM-81-2047			
BUDGET CYCLE: 2023-2026			
Project Number	Project Name	Description	Percentage Funded
230001	Advanced Energy Research Facility Renewal	Advanced Energy Research Facility Renewal	100
230002	Cure Site Concrete Rehabilitation	Cure Site Concrete Rehabilitation	100
230003	EWMC Geoware Upgrades	EWMC Geoware Upgrades	100
230004	Coronation Eco Station Groundwater Wells	Coronation Eco Station Groundwater Wells	100
230005	RDF Fire Protection Regulatory Upgrades	RDF Fire Protection Regulatory Upgrades	100



Waste Services IIS Infrastructure Planning and Design

Composite - Capital Funding Request

City Operations | Waste Services

City of Edmonton

Capital Profile: CPP# CM-81-0005

Project Number: CP# / OP# Various

Profile Owner: Krista Berezowski

Profile Sponsor: Denis Jubinville

Version #: 2.0

Date published: August 31, 2022

page intentionally left blank

TABLE OF CONTENTS

Document Approval	5
Indigenous Acknowledgement	6
Executive Summary	8
IIS Project Development and Delivery Model (PDDM) Composite Renewal	8
Background	8
Problem / Opportunity	9
Current Situation	9
Initiative Description	9
Initiative Description	9
Urgency of Need	10
Anticipated Outcomes	10
Scope	11
Out of Scope	12
Critical Success Factors	12
Strategic Alignment	12
Context Analysis	14
Organizational Change Impact	14
Stakeholder Impact	14
Business and Operational Impact	15
Benefits / Costs	15
Tangible Benefits	15
Intangible Benefits	16
Costs	16
Assumptions	16
Resourcing	17
Key Risk(s) and Mitigation Strategy	17
Conclusion and Recommendations	18
Conclusion	18
Recommendations	18
Project Responsibility and Accountability	18
Implementation Approach	18
Review and Approval Process	19

Appendices	19
Appendix A: Waste Services Internal Project Planning and Prioritization Process	20
Appendix B: Project Descriptions -2023-2026	21
Appendix C: Financial Analysis Summary	22

Change History

Version #	Date	Author	Description
1.0	08/05/22	Lena Aitken	First draft of the Capital Funding Request
2.0	08/17/22	Lena Aitken	Second draft of the Capital Funding Request

Document Approval



SUBMITTED BY:

Version #	Submitter Name	Title	Submission Date
2.0	Lena Aitken	Senior Project Engineer	August 17, 2022

REVIEWED BY:

Version #	Reviewer Name and Title	Signature	Signing Date
2.0	Keith Knoblauch Operational Controller, Business Financial Analytics	Keith Knoblauch	Sep 10, 2022
2.0	Jodi Goebel Director, Business Integration	Jodi Goebel	Sept 11, 2022
2.0	Neil Kjelland Director, Sustainable Waste Processing	Neil Kjelland	Aug 22, 2022
2.0	Chris Fowler Director, Collections Services	Chris Fowler	9/12/22
2.0	Crystal Wood Communications Advisor	Crystal Wood	Aug 19, 2022
2.0	Shannon Fitzsimmons Director of Facility Planning		2022-09-14

APPROVED BY:

Version #	Approver Name and Title	Signature	Signing Date
3.0	Krista Berezowski Director, Technical Services		Sept 12, 2022
3.0	Denis Jubinville Branch Manager, Waste Services		Sept 15, 2022

Indigenous Acknowledgement

Edmonton is located within Treaty 6 Territory and within the Métis homelands and Métis Nation of Alberta Region 4. We acknowledge this land as the traditional territories of many First Nations such as the Nehiyaw (Cree), Denesuliné (Dene), Nakota Sioux (Stoney), Anishinaabe (Saulteaux) and Niitsitapi (Blackfoot).

The City of Edmonton owes its strength and vibrancy to these lands and the diverse Indigenous peoples whose ancestors' footsteps have marked this territory as well as settlers from around the world who continue to be welcomed here and call Edmonton home.

Together we call upon all our collective honoured traditions and spirits to work in building a great city for today and future generations.



1. Executive Summary

1.1. Waste Services IIS Infrastructure Planning and Design Composite Renewal

Composite profile CM-81-0005 supports the preliminary planning and design work completed by the Integrated Infrastructure Services (IIS) Infrastructure Planning and Design Branch for Waste Services capital projects. The Waste Services capital projects within this profile are aligned with the projects in composite profile CM-81-2045 (Waste Services IIS Infrastructure Delivery).

The approach followed for the preliminary planning and design work is consistent with Administration's implementation of the Project Development & Delivery Model (PDDM) as well as the Capital Project Governance Policy C591¹ approved by the Council in April 2017. The outcome of this profile is to provide Council with better information regarding the scope, schedule and budget of the proposed capital projects prior to full funding of the project.

Adherence to both the PDDM process as well as Policy C591 will ensure sufficient information is prepared in advance of the Capital budget process to support informed investment decisions, provide adequate resources for planning and design to ensure appropriate level of planning and design is incorporated into budget submissions for the Utility Rate Filing and provide an overall framework to guide the management of Waste Services' capital projects.

This Capital Funding Request establishes funding prioritization for Waste Services projects anticipated to enter the project planning stage, checkpoints 1, 2 and 3 (as described below), of the PDDM. This gated approach for capital projects is to ensure that projects are properly developed before they are funded for delivery.

While approval of this profile is necessary to determine the Waste Services capital budget and utility rates, approval of this profile does not indicate final budget or funding approval for any specific capital project.

The four year capital projection for this profile is approximately \$2.73 million. A high-level list of projects is listed in Appendix B.

2. Background

In 2016, the IIS Transformation program developed the PDDM which was endorsed by Council in 2017. The PDDM is a framework to manage capital infrastructure projects and represents best practices in project management from industry and comparable municipalities. It aims to achieve the following outcomes²:

- (1) Better information to make capital investment decisions.
- (2) Improved project schedule and budget estimates through increased level of design to ensure realistic expectations are set prior to project tendering and construction.
- (3) Systematic evaluation of projects against the initial project business case and scope.

¹ <https://www.edmonton.ca/documents/PoliciesDirectives/C591.pdf>

² Integrated Infrastructure Services report CR_4120

The PDDM flow chart is as below:



IIS delivers Waste Services capital projects using the PDDM process.

2.1. Problem / Opportunity

The current Council-directed approach will assist Waste Services in the management of capital projects in alignment with the PDDM process. The PDDM process offers a gated system where the budget for comprehensive planning and design can be released in advance and once complete, decisions can be made regarding investments pertaining to the delivery of the projects rather than releasing the project budget as a whole upfront. Without the additional details from a comprehensive planning and design process, the project estimates contained high-value contingencies and the accuracy of the schedule and budget estimates varied significantly. Following the PDDM process will mitigate this risk and improve project and budget management practices for Waste Services.

Projects included in this composite profile will address a number of Waste Services business needs such as the renewal of assets that have reached the end of their useful life, mitigation and elimination of safety and environmental risks and the need and opportunity for growth and continuous improvement.

2.2. Current Situation

Waste Services started using the PDDM model under the direction of Council in 2017. Under this, funding for the project design and planning will be released to IIS prior to the delivery of the project to ensure on-time and on-budget completion of the capital projects for Waste Services. Waste Services will continue to follow this process in the future.

3. Initiative Description

3.1. Initiative Description

This capital profile supports preliminary planning and design work on Waste Services infrastructure capital projects prior to budget approval. This approach is consistent with

Administration's implementation of the PDDM as well as the Capital Governance Policy approved by Council in 2017. Separate funding for the construction and delivery component of the projects (after Checkpoint 3) is under the Waste Services IIS Infrastructure Delivery composite CM-81-2045.

Funding in the profile will be used to support preliminary planning and design work for Waste Services capital initiatives planned for delivery between 2023 and 2026. These projects include, but are not limited to:

- Waste Water Discharge Expansion
- North Saskatchewan River (NSR) Erosion Control
- Cure Site Pad B, C and G Resurfacing
- Edmonton Waste Management Centre (EWMC) Water Distribution System Upgrades
- EWMC Site Paving
- Organics Transformer yard grading/drainage
- Organics Tip Floor Cupola
- Organics Staff Facilities Upgrades
- Organics Tip Floor Source Capture
- Organics Tip Floor Drainage Enhancement
- Integrated Process and Transfer Facility (IPTF) - Additional Metal Removal System
- Residential Transfer Station (RTS) Pad and Buildings Upgrades
- Compost School Refresh
- Kennedale Entrance Gates

For further details, please refer to project descriptions in Appendix B.

A list of required projects was submitted by the operational areas to Technical Services, indicating the project scope, schedule, risks and estimates. These were evaluated, ranked and prioritized based on the strategic and operational criteria (i.e. Project Driver and the Project Criticality) set by Technical Services. Appendix A - Waste Services Internal Project Planning and Prioritization Process outlines the prioritization process.

3.2. Urgency of Need

To adhere with the PDDM approach, preliminary planning and design should be completed on projects prior to the project's budget being approved in its entirety. This composite profile funds this work for Waste Services, ensuring Administration can provide Utility Committee with better information regarding the scope, schedule and budget prior to approving and funding the entire project.

3.3. Anticipated Outcomes

In alignment with the PDDM approach, Waste Services will achieve the Utility's goals through working with IIS to effectively manage the planning and design of capital projects. Waste Services envisions the following outcomes:

Outcomes / Deliverables
Better information to make capital investment decisions: Through a structured and integrated process, administration will ensure that projects identified as priorities by Waste Services receive robust evaluation of alternatives and scope identification. Through the PDDM process, project maturity is regularly assessed to ensure that projects are ready to advance to the next stage of development.
Improved project schedule and budget estimates based on enhanced design details: Early investment of capital design resources allows sufficient lead time allocated on planning of the projects, thus decreasing the possibility of project scope and budget changes. Completing design work early in a project life cycle allows the greatest ability to impact overall project outcomes.
Reliable facilities and infrastructure that enable sustainable waste management in a cost-effective manner.
High levels of customer service delivered in both an efficient and effective way through leading-edge waste processing facilities that use current and emergent technology to enable high rates of diversion of waste from landfill.
Facilities that can be operated in a safe manner, protecting employees, customers and contractors.

3.4. Scope

The scope of this Capital Funding Request includes the concept and schematic design of the PDDM approach which includes Checkpoint 1 (Project initiation), Checkpoint 2 (Authorization for Design Expenditure) and Checkpoint 3 (Approval for Capital Expenditure) documentation and review for all Capital projects being managed by IIS on behalf of Waste Services.

Checkpoint 1: Projects are reviewed for readiness to begin the design process and approve funding for concept planning. This stage includes assessment of the project for maturity, appropriate definition of scope and priority.³

Checkpoint 2: This checkpoint is to establish readiness of the project to complete the Concept Phase and begin to develop the project to an appropriate level of maturity to request capital funding. Once concept planning is complete, the project will be evaluated for priority to receive additional design funding for Development Design. Project must be at an appropriate maturity level and the scope must be confirmed.⁴

Checkpoint 3: This checkpoint is to verify the project has reached an appropriate level of maturity to request capital funding. Projects will be taken to a level of design that will yield more reliable estimates before being put forward for prioritization and inclusion in the Capital Budget.

³ Source: <https://sites.google.com/a/edmonton.ca/pmrg/pddm/checkpoint-1>

⁴ Source: <https://sites.google.com/a/edmonton.ca/pmrg/pddm/checkpoint-2>

This is often to a Class 3 (- 15% to +20%) during Design Development. The project must be developed enough to move forward and the scope must be reviewed⁵

During Checkpoint 3, the project budget has been approved (led by the IIS Planning and Design Project Manager) and the transfer from the Planning and Design Branch to Delivery Branch occurs.

3.5. Out of Scope

The project delivery phase of the PDDM is out of the scope for this Capital Funding Request. This typically includes Checkpoint 4 (Authorization for Construction expenditure) and Checkpoint 5 (Authorization for closeout) of the PDDM as these seek approval in a separate Capital Funding Request ([CM-81-2045. Waste Services IIS Infrastructure Delivery](#)).

3.6. Critical Success Factors

Critical success factors include:

- Efficient, consistent and accurate communication between Waste Services and IIS.
- Regular check-ins with the Waste Services Leadership Team to align with the strategic direction and the Utility's goals.
- Accurate and sufficient data and cost analyses to support high level budget estimates and informed decision making for the projects.
- On time, on budget delivery of capital projects within the PDDM.

4. Strategic Alignment

This initiative contributes to the overall City of Edmonton strategic direction and to corporate and departmental business plans, including Connect Edmonton: Vision 2050. This contribution is made by demonstrating leadership in waste management and processing standards, and by increasing the diversion of residential and non-residential waste from landfill. Below are strategies, business plans and policies that support this project:

⁵ Source: <https://sites.google.com/a/edmonton.ca/pmrg/pddm/checkpoint-3>

<p><i>City of Edmonton Environmental Policy C512</i></p>	<p>POLICY STATEMENT:</p> <p>The City of Edmonton, through its planning, decision-making processes, and leadership, will promote the development of an environmentally sustainable community that functions in harmony with the natural environment.</p> <p>The City of Edmonton will exercise environmental stewardship of its operations, products and services, based on its commitment to:</p> <ul style="list-style-type: none"> (a) prevent pollution (b) continually improve its environmental performance by setting and reviewing environmental objectives and targets (c) meet or exceed applicable environmental legal requirements and other requirements to which it subscribes
<p><i>Connect Edmonton: Vision 2050</i></p>	<p>This project aligns with the City’s Vision 2050 strategic plan in that by ensuring that organic/food waste is collected, processed responsibly, and the amount landfilled is minimized, Edmonton will be a healthy city, urban places will be clean, regional prosperity is increased by building a circular economy, and a low-carbon future is assured.</p>
<p><i>Waste Services Business Plan 2022-2025</i></p>	<p>The Business Plan outlines how Waste Services will continue to make transformational impacts through the 25-year Waste Strategy, provide essential service to Edmontonians while maintaining full cost recovery, and improve the employee and resident experience to support adaptation of new systems.</p>
<p><i>25-Year Waste Strategy</i></p>	<p>“The strategy adopts a broader lens to transform the system with new focus on efforts which will emphasize waste reduction in addition to affirming a commitment to 90% diversion of single-unit residential waste from landfill.”</p>
<p><i>Waste Services Utility Fiscal Policy C558B</i></p>	<p>“Customer rates will promote the efficient use of resources and be set to achieve broader social, economic, and environmental goals.”</p>

<p><i>Integrated Infrastructure Services (IIS) Vision and Mission Statements</i></p>	<p>“We inspire trust among citizens and Council in our commitment and ability to deliver quality infrastructure.”</p> <p>We are in the business of:</p> <ul style="list-style-type: none"> ● bringing ideas to reality ● innovation and excellence ● assembling expertise ● building legacy infrastructure ● helping citizens have a better life in Edmonton ● Building a Great City
--	--

5. Context Analysis

Requested funding for project planning and design work for capital projects is consistent with Administration's implementation of the PDDM as well as the Capital Governance Policy approved by Council in 2017.

6. Organizational Change Impact

Waste Services staff, reporting through the Technical Services section, work closely with IIS to plan and design capital projects. This Capital Funding Request represents the continuation of current business practice, so no additional organizational change impact is expected.

6.1. Stakeholder Impact

Stakeholder Impact
Stakeholder 1: City of Edmonton Waste Services Branch (primary internal)
<ol style="list-style-type: none"> 1. Well-defined and consistent process in alignment with rest of the City 2. Enhanced consultation, recommendation and approval for Planning and Design checkpoints for Waste Services Projects managed by IIS as part of a project team
Stakeholder 2: Integrated Infrastructure Services (primary internal)
<ol style="list-style-type: none"> 1. Enhanced Project Management for approved capital projects using input from Waste Services 2. Improved process for capital funding for projects in the composite profile for Waste Services
Stakeholder 3: City Council (primary internal)
<ol style="list-style-type: none"> 1. Increased transparency, accuracy, reliability of project schedule and budget estimates

2. Ability to provide political direction and have access to accurate project information
Stakeholder 4: City of Edmonton public (secondary external)
1. Maintenance of stable/low utility rate through the effective delivery of capital projects 2. Minimal disruption to service levels through the delivery process

6.2. Business and Operational Impact

The table below identifies the business and operational impacts for continuing to follow the PDDM model as recommended by Waste Services.

Business & Operational Impact & Description
Waste Services (primary internal)
<ul style="list-style-type: none"> • More planning required from Waste Services-allocated resources to support completing Checkpoint 1 requirements and supporting Checkpoint 2 and Checkpoint 3 documents preparation
Integrated Infrastructure Services - Infrastructure Planning & Design (primary internal)
<ul style="list-style-type: none"> • More planning required from the allocated resources to support Checkpoint 1 transition and complete the conceptual and schematic design, as well as Checkpoint 2 and Checkpoint 3 documents preparation

Moving forward, the City of Edmonton is committed to the use of Gender-Based Analysis Plus (GBA+). Waste Services will identify root causes on any issues that may arise, use an evaluation approach, consider the inputs from affected stakeholders (e.g. people with disabilities, indigenous people, seniors, etc.), and develop and implement an action plan for safety, diversity and inclusivity issues using GBA+. Waste Services acknowledges that GBA+ is an equity assessment tool that allows for holistic consideration of the need for use, and impact of, this Capital Funding Request and that staff are trained in the GBA+ process.

7. Benefits / Costs

7.1. Tangible Benefits

The following tangible benefits are expected to be realized by following this approach:

- Improved operational efficiency of facilities, infrastructure and process equipment.
- Reduction in safety-related incidents.
- Long term savings due to process and operational improvements.
- Meet or exceed environment compliance requirements.

7.2. Intangible Benefits

The following intangible benefits will be realized by following the new approach:

- Improved efficiency in project management.
- Increased adherence to budget and schedule estimates.
- Improved ability to forecast capital expenditure thus allowing for more certainty in utility rates for the budget cycle.
- Structured process to evaluate readiness, scope and prioritization.
- Increased project accountability, awareness and controls.
- Closer integration of City departments.
- Better opportunities to make major changes in project scope if problems are identified during the early planning and design phases.
- Closer integration of City departments.

7.3. Costs

REQUEST	2023	2024	2025	2026	TOTAL PROFILE BUDGET
Capital Budget Request	\$1,074,675	\$890,419	\$187,630	\$120,710	\$2,273,434

The list of projects under this profile for 2023-2026 budget cycle is attached in Appendix B.

Please refer to Appendix C for the Financial Analysis Summary. However, please note the table and graph demonstrating the revenue requirement related to these capital costs are included in the Waste Services IIS Infrastructure Delivery Capital Funding Request under Appendix C. This graph **includes both** Planning and Design and Project Delivery to show the full impact of the projects.

7.4. Assumptions

- Projects in this composite profile have allocated budget amounts that are based on high-level estimates. The actual costs of the approved capital projects in this composite profile may vary once the preliminary planning stage is completed by IIS.
- All of the proposed projects in this composite profile have been prioritized based on the approval of Waste Services' proposed program changes that are pending decisions of Utility Committee and Council.

8. Resourcing

Early investment in design by IIS will require reallocation of capital funding to planning and design efforts prior to project-specific approval from Waste Services. There is no expected additional resourcing impact on Waste Services FTE.

9. Key Risk(s) and Mitigation Strategy

RISK(S)	IMPACT	MITIGATION STRATEGY
Extended project planning time required due to additional inter-departmental coordination	Medium	<ul style="list-style-type: none"> ● Clarify and implement mutual expectations between IIS and Waste Services ● Work with IIS to fast track projects requiring Alberta Environment and Parks approval to meet the regulatory timelines
Project scope may change and a revised preliminary planning and design plan is required to ensure project deliverables are met	Medium	<ul style="list-style-type: none"> ● Rework the scope and design to fit the intended outcome ● Enhanced project communication between IIS and Waste Services ● Increased collaboration and shared decision making between IIS and Waste Services.
Scope is not fully developed during Strategy phase and requirements are not fully developed for Planning & Design or Delivery phases	Medium	<ul style="list-style-type: none"> ● Scope is revisited during Planning & Design phase to ensure that all requirements are understood and documented. Requirements that are missed in Planning & Design phase would likely have a severe or higher impact during delivery
Projects may not get approved after spending resources on concept planning and design	Low	<ul style="list-style-type: none"> ● Re-work the scope and designs to fit Councils expectations or cancel the project based on Council's decision
Projects may not proceed or may be delayed due to other Branch priorities	Low	<ul style="list-style-type: none"> ● Keep project team updated on branch priorities ● Constantly checking the branch strategy and project alignment with the Branch goals ● Change of project schedule and

		deliverables
Projects may be canceled if the project planning and design does not meet the intended outcome	Low	<ul style="list-style-type: none"> ● Rework the scope and design to fit the intended outcome ● Enhanced project communication between IIS and Waste Services ● Increased collaboration and shared decision-making between IIS and Waste Services

10. Conclusion and Recommendations

10.1. Conclusion

This Capital Funding Request evaluated the overall capital budget for preliminary planning and design work completed by IIS Infrastructure Planning and Design Branch for Waste Services for the budget period 2023-2026. Funds are required for planning and design to adhere to the PDDM, improve project schedule adherence, and improve budget estimates through an increased level of design. The four-year capital projection for this profile is approximately \$2.73 million.

10.2. Recommendations

Waste Services recommends continuing to follow the PDDM and approve funds for the project planning and design phase for all capital projects managed by IIS. This will lead to better information to make capital investment decisions, and improved project schedule and budget estimates before full budget approval is received.

10.3. Project Responsibility and Accountability

The Project Sponsor and budget owner for all approved capital projects in this composite profile is the Branch Manager of Waste Services. The overall capital program is managed by the Director of Technical Services. Individual projects are led by Project Managers that report to the General Supervisors of Technical Services.

11. Implementation Approach

IIS will complete the planning and design phase for the respective projects listed in Appendix B for Waste Services. The respective project managers from Waste Services and IIS will be responsible for accurate spending of these funds and timely completion of the projects. The estimated completion of the planning and design phase for the projects for the 2023-2026 budget cycle is four years. This profile also requests funding for projects that will be delivered in the 2027-2030 budget cycle. The planning and design for all the listed projects will be completed by 2026.

12. Review and Approval Process

The following review and approval process was followed for this Capital Funding Request:

Review Step	Reviewer
Review 1	Team Lead of Technical Services, General Supervisor of Business Integration Integration, General Supervisor of CS, General Supervisors of SWPS, General Supervisors of Technical Services, Program Manager of IIS P&D, General Supervisor of IIS P&D, General Supervisor of IIS OSPD, and Senior Accountant of Financial Services.
Review 2	Director of Finance, Director of Business Integration, Director of Technical Services (Final Approver), Director of SWPS, Director of CS, Director of IIS P&D, and Senior Communications Advisor.
Review 3	Branch Manager Waste Services (Final Approver)
Review 4	Utility Advisor
Review 5	Utility Committee report presented

13. Appendices

Appendix A: Waste Services Internal Project Planning and Prioritization Process

Appendix B: Waste Services (IIS Managed) Planning & Design Project Descriptions - 2023-2026

Appendix C: Financial Analysis Summary - Waste Services (IIS Managed) Planning & Design composite profile

Appendix A: Waste Services Internal Project Planning and Prioritization Process

The following outlines the Project Prioritization process:

1. Capital project needs are identified from all sections of the Utility and listed on the [2023-26 Waste Services Capital Planning Sheet](#).
2. Each project is scored based on the Project Driver and the Project Criticality. See tables 1 and 2 below for details. Total project score for each project is calculated by multiplying the driver and criticality scores.
3. Projects are then prioritized based on the total scores.
4. Projects are recommended based on prioritization with budget estimates.
5. Waste Services Leadership Team (WSLT) reviews and approves the final list.
6. Planning, documentation, and approval process for each individual project follows the approved [Waste Services Project Management Framework](#).
7. Re-prioritization exercises occur on a bi-annual basis for possible adjustments according to Branch priority.

Table 1: Project Driver

Project Driver (score)						
Regulatory / Compliance (5)	Safety / Environmental Enhancement (5)	Asset Renewal/Upgrade (4)	Business Need / Growth (3)	Strategic / Corporate Goal (3)	Process / Operational Improvement (3)	Other (3)

Table 2: Project Criticality

Project Criticality (score)		
Critical - cannot be deferred (3)	Very Important - cannot be deferred (2)	Can be deferred (1)

Appendix B: Waste Services (IIS Managed) Delivery Project Descriptions - 2023-2026

The following table shows projects anticipated to be undertaken for this budget cycle:

Project	Description	Project Driver / Objective
Waste Water Discharge Expansion	Design and construction of a pump station and associated gathering infrastructure to connect the EWMC groundwater diversion system and sanitary infrastructure to the EPCOR wastewater treatment plant.	Regulatory/Compliance
North Saskatchewan River (NSR) Erosion Control	Design and construction of North Saskatchewan River bank stabilization to reduce erosion and slope stability issues adjacent to the Clover Bar Landfill.	Safety/Environmental Enhancement
Cure Site Pad B, C and G Resurfacing	The project supports the renewal of the existing cure site. The current site is approaching the end of its life cycle and major capital renewal work needs to be done with regard to the site liner and site drainage.	Asset Renewal/Upgrade
EWMC Water Distribution System Upgrades	Implementation of recommended water distribution upgrades to meet fire flow and operational requirements at the EWMC.	Safety/Environmental Enhancement
EWMC Site Paving	Project supports new paving requirements throughout the EWMC.	Asset Renewal/Upgrade
Organics Transformer yard grading	Project supports civil design and construction to allow for adequate drainage in an area with high voltage electrical equipment.	Safety/Environmental Enhancement
Organics Tip Floor Cupola	Project supports modification to the Organics tip floor building allowing for proper and safe removal of the trommel screen from its drum without removing the entire trommel from its location in the process.	Asset Renewal/Upgrade
Organics Staff Facilities Upgrades	Needs analysis for ADF/Organics office, locker room and control room space, and staff walkways. Project delivery to be included.	Asset Renewal/Upgrade: Improving the staff facilities for the ADF.

Organics Tip Floor Source Capture	Needs analysis and implementation of dust collection in order to meet environmental requirements.	Safety/Environmental Enhancement
Organics Tip Floor Drainage Enhancement	Project supports needs analysis and modification to the Organics Tip Floor to allow for adequate drainage.	Business Need/Growth
IPTF - Additional metal removal system	Project will deal with the analysis of current metal removal and improvement options	Process/Ops Improvement
RTS pad and buildings upgrade	Project supports the upgrade and replacement of aging RTS buildings	Asset Renewal/Upgrade
Compost School Refresh	Develop and implement a master plan for scaled improvements to Compost School, located beside the John Janzen Nature Centre (7000 143 St NW).	Strategic / Corporate Goal
Kennedale Entrance Gates	Replacement of manual gates with automated gates to provide adequate security at the Kennedale Waste Collections Site.	Safety/Environmental Enhancement

Appendix C: Costs - Financial Analysis Summary (Waste Services Planning and Design Composite Profile)⁶:

Project Title: IIS Planning & Design	Planning & Design
Total Capital Cost	(\$2,273,434)
Total Revenues	\$0
Total Operating and Maintenance Costs	\$0
Total Lease Costs	\$0
Project Net Inflows (Outflows)	(\$2,273,434)
WACC Discount Rate	6.28%
Project Cost (Present Value)	(\$1,929,345)

Notes: Planning and Design costs have been added to the Waste Services IIS PDDM Delivery Capital Funding Request costs for revenue requirement calculation purposes in order to demonstrate the full project spending. **Please refer to Appendix C of the Waste Services IIS PDDM Delivery Capital Funding Request for the resulting analysis.**

Capital projects within this profile are presented at a concept level and as such, associated operating and maintenance costs are not identified at this time. These costs for each project will be considered and included in the individual business cases at Checkpoint 3.

⁶ [IIS Planning & Design Profile - Business Case 2023-26 - Fin Analysis v05.31.22](#)

CAPITAL PROFILE REPORT

PROFILE NAME: **WASTE SERVICES IIS INFRASTRUCTURE PLANNING AND DESIGN**

**RECOMMENDED
FUNDED**

PROFILE NUMBER: **CM-81-0005**

PROFILE STAGE: **Approved**

DEPARTMENT: **Integrated Infrastructure Services**

PROFILE TYPE: **Composite**

LEAD BRANCH: **Infrastructure Planning and Design**

LEAD MANAGER: **Pascale Ladouceur**

PARTNER: **Waste Services**

PARTNER MANAGER: **Denis Jubenville**

BUDGET CYCLE: **2023-2026**

ESTIMATED START: **January, 2023**

ESTIMATED COMPLETION: **December, 2026**

Service Category: **Utilities**

Major Initiative:

GROWTH
50

RENEWAL
50

PREVIOUSLY APPROVED: **-**

BUDGET REQUEST: **2,273**

TOTAL PROFILE BUDGET: **2,273**

PROFILE DESCRIPTION

This composite program supports preliminary planning and design work on Utility Infrastructure capital projects prior to budget approval. This approach is consistent with Administration's implementation of the Project Development & Delivery Model (PDDM), as well as the Capital Governance Policy C591 that was adopted by Council in April 2017. The outcome of this profile is to provide Council with better information regarding the scope, schedule and budget of the proposed capital projects prior to full funding of the project.

Adherence to both the PDDM process as well as Policy C591 will ensure that sufficient information is prepared in advance of the Capital budget process to support informed investment decisions, provide adequate resources for planning and design to ensure appropriate level of planning and design is incorporated into budget submissions and provide an overall framework to guide the management of the Waste Services' capital projects.

As PDDM has previously been adopted by Council, this capital funding request establishes funding prioritization for Waste Services projects anticipated to enter the project planning stage within a checkpoint system with strategic controls on budget and schedule. The PDDM approach is a gated process for capital projects to ensure that projects are properly developed before they are funded for delivery.

While approval for funding in this profile is required to establish the initial 2023-2026 capital budget and projected utility rate increases over the 4 year period, approved funding for this profile does not indicate final budget or funding for any specific capital project.

PROFILE BACKGROUND

In 2016, the Integrated Infrastructure Services (IIS) Transformation program developed the PDDM which was endorsed by Council in 2017. The PDDM is a framework to manage all capital infrastructure projects and represents the best practices in project management from the industry and comparable municipalities. It aims to achieve the following outcomes:

- Better information to make capital investment decisions
- Improved project schedule and budget estimates through increased level of design to ensure realistic expectations are set prior to project tendering and construction
- Systematic evaluation of projects against the initial project business case and scope.

PROFILE JUSTIFICATION

The current council directed approach will assist Waste Services in the management of capital projects in alignment with the PDDM process. The PDDM process offers a gated system where budget for comprehensive planning and design can be released in advance and once complete, decisions can be made regarding investments pertaining to the delivery of the projects rather than releasing the project budget as a whole upfront, as was prior practice. Without the additional details from a comprehensive planning and design process, the project estimates contained high value contingencies and the accuracy of the schedule and budget estimates varied significantly. Following the PDDM process will mitigate this risk and improve project and budget management practices for Waste Services. Projects included in this composite profile will address a number of Waste Services business needs such as the renewal of assets that have reached the end of their useful life, mitigation and elimination of safety and environmental risks and the need and opportunity for growth and continuous improvement.

STRATEGIC ALIGNMENT

Projects following the PDDM approach for Waste Services align with the following strategic goals of City of Edmonton:

Healthy City/Urban Places/Regional Prosperity/Climate Resilience

In addition to this overarching corporate alignment structure, individual projects approved within this composite profile will align with the City of Edmonton's Waste Management Policy C527 and Waste Management Utility Fiscal Policy C558A as well as the Capital Project Governance Policy C591. This profile also aligns with Waste Services integrated 25-year strategic outlook.

ALTERNATIVES CONSIDERED

This is a capital funding request and does not present any alternatives for consideration.

COST BENEFITS

Tangible:

- Accurate information to make better capital decisions
- Accurate project budget and schedule estimate
- Improved efficiency in project management

Intangible:

- Allows early investment in design to support detailed business cases
- Structured process to evaluate project readiness, scope and prioritization
- Increase opportunities to make major changes in project during planning and design
- Increased project accountability

KEY RISKS & MITIGATING STRATEGY

RISK: Extended project planning time required due to additional inter-departmental coordination

MITIGATION: Clarify and implement mutual expectations between IIS and Waste Services and work with IIS to fast track projects requiring Alberta Environment and Parks approval to meet the regulatory timelines

RISK: Projects scope may change and a revised preliminary planning and design plan is required to ensure project deliverables are met

MITIGATION: Rework the scope and design to fit the intended outcome; Enhanced project communication between IIS and Waste Services

RISK: Scope is not fully developed during Planning & Design or Delivery phases

MITIGATION: Scope is revisited during Planning & Design phase to ensure that all requirements are understood and documented.

RESOURCES

Projects will be delivered using a combination of internal and external resources. Where possible, internal forces will be used to manage and undertake the work. All procurement of external resources will follow relevant corporate procurement directives & policies.

CONCLUSIONS AND RECOMMENDATIONS

Conclusion: Funds are required for planning and design to adhere with the Project Development and Delivery Model, improve project schedule adherence and improve budget estimates through increased level of design. A capital budget of approximately \$2,273,434 million is required for the preliminary planning and design for various projects in Waste Services composite profile in the next 4 years.

Recommendation: Waste Services is recommending to continue following the PDDM proposed by IIS and release funds for project planning and design phase for all capital projects managed by IIS. This will lead to better information to make capital investment decisions, and improved project schedule and budget estimates before full budget approval is received.

CAPITAL PROFILE REPORT

PROFILE NAME: **Waste Services IIS Infrastructure Planning and Design**

RECOMMENDED FUNDED

PROFILE NUMBER: **CM-81-0005**

PROFILE TYPE: **Composite**

BRANCH: **Infrastructure Planning and Design**

CAPITAL BUDGET AND FUNDING SOURCES (000's)

APPROVED BUDGET		Prior Years	2022	2023	2024	2025	2026	2027	2028	2029	2030	Beyond 2030	Total
	Approved Budget												
	Original Budget Approved	-	-	-	-	-	-	-	-	-	-	-	-
	Current Approved Budget	-	-	-	-	-	-	-	-	-	-	-	-

BUDGET REQUEST	Budget Request	-	-	1,075	890	188	121	-	-	-	-	-	2,273
	Revised Funding Sources (if approved)												
	Waste Mgt Retained Earnings	-	-	1,075	890	188	121	-	-	-	-	-	2,273
	Requested Funding Source	-	-	1,075	890	188	121	-	-	-	-	-	2,273

REVISED BUDGET (IF APPROVED)	Revised Budget (if Approved)	-	-	1,075	890	188	121	-	-	-	-	-	2,273
	Requested Funding Source												
	Waste Mgt Retained Earnings	-	-	1,075	890	188	121	-	-	-	-	-	2,273
	Requested Funding Source	-	-	1,075	890	188	121	-	-	-	-	-	2,273

CAPITAL BUDGET BY ACTIVITY TYPE (000's)

REVISED BUDGET (IF APPROVED)	Activity Type	Prior Years	2022	2023	2024	2025	2026	2027	2028	2029	2030	Beyond 2030	Total
		Design	-	-	1,075	890	188	121	-	-	-	-	-
	Total	-	-	1,075	890	188	121	-	-	-	-	-	2,273

OPERATING IMPACT OF CAPITAL

Type of Impact:

Branch:																
	Rev	Exp	Net	FTE	Rev	Exp	Net	FTE	Rev	Exp	Net	FTE	Rev	Exp	Net	FTE
Total Operating Impact	-	-	-	-	-	-	-	-	-	-	-	-	-	-	-	-

CAPITAL PROFILE REPORT

PROFILE NAME: Waste Services IIS Infrastructure Planning and Design**PROFILE NUMBER: CM-81-0005****BUDGET CYCLE: 2023-2026**

Project Number	Project Name	Description	Percentage Funded
230001	Waste Water Discharge Expansion	Waste Water Discharge Expansion	100
230002	North Saskatchewan River (NSR) Erosion Control	North Saskatchewan River (NSR) Erosion Control	100
230003	Cure Site Pad B, C and G Resurfacing	Cure Site Pad B, C and G Resurfacing	100
230004	Edmonton Waste Management Centre (EWMC) Water Distribution System Upgrades	Edmonton Waste Management Centre (EWMC) Water Distribution System Upgrades	100
230005	EWMC Site Paving	EWMC Site Paving	100
230006	Organics Transformer yard grading/drainage	Organics Transformer yard grading/drainage	100
230007	Organics Tip Floor Cupola	Organics Tip Floor Cupola	100
230008	Organics Staff Facilities Upgrades	Organics Staff Facilities Upgrades	100
230009	Organics Tip Floor Source Capture	Organics Tip Floor Source Capture	100
230010	Organics Tip Floor Drainage Enhancement	Organics Tip Floor Drainage Enhancement	100
230011	Integrated Process and Transfer Facility (IPTF) - Additional Metal Removal System	Integrated Process and Transfer Facility (IPTF) - Additional Metal Removal System	100
230012	Residential Transfer Station (RTS) Pad and Buildings Upgrades	Residential Transfer Station (RTS) Pad and Buildings Upgrades	100
230013	Compost School Refresh	Compost School Refresh	100
230014	Kennedale Entrance Gates	Kennedale Entrance Gates	100



Waste Services IIS Infrastructure Delivery Composite Capital Funding Request

City Operations | Waste Services
City of Edmonton

Capital Profile: CPP# CM-81-2045
Project Number: CP# / OP# Various

Profile Owner: Krista Berezowski
Profile Sponsor: Denis Jubinville

Version #: 2.0

Date published: August 31, 2022

page intentionally left blank

TABLE OF CONTENTS

Change History	5
Document Approval	5
Indigenous Acknowledgement	7
Executive Summary	8
IIS Project Development and Delivery Model (PDDM) Composite Renewal	8
Background	8
Problem / Opportunity	9
Current Situation	9
Initiative Description	9
Initiative Description	9
Urgency of Need	11
Anticipated Outcomes	11
Scope	12
Out of Scope	12
Critical Success Factors	13
Strategic Alignment	13
Context Analysis	14
Organizational Change Impact	14
Stakeholder Impact	14
Business and Operational Impact	15
Benefits / Costs	16
Tangible Benefits	16
Intangible Benefits	16
Costs	16
Assumptions	16
Resourcing	17
Key Risk(s) and Mitigation Strategy	17
Conclusion and Recommendations	17
Conclusion	17
Recommendations	18
Project Responsibility and Accountability	18
Implementation Approach	18
Review and Approval Process	18
Appendices	19

Appendix A: Waste Services Internal Project Planning and Prioritization Process	20
Appendix B: Project Descriptions -2023-2026	21
Appendix C: Financial Analysis Summary	23

Change History

Version #	Date	Author	Description
1.0	08/05/2022	Lena Aitken	First draft
2.0	08/17/2022	Lena Aitken	Second draft

Document Approval



SUBMITTED BY:

Version #	Submitter Name	Title	Submission Date
2.0	Lena Aitken	Senior Project Engineer	August 17, 2022

REVIEWED BY:

Version #	Reviewer Name and Title	Signature	Signing Date
2.0	Keith Knoblauch Operational Controller, Business Financial Analytics	Keith Knoblauch	Sep 09, 2022
2.0	Jodi Goebel Director, Business Integration	Jodi Goebel	Sept 11, 2022
2.0	Neil Kjelland Director, Sustainable Waste Processing	Neil Kjelland	Aug 22, 2022
2.0	Chris Fowler Director, Collections Services	Chris Fowler	9/14/22
2.0	Crystal Wood Communications Advisor	Crystal Wood	Aug 19, 2022
2.0	Jesse Banford Director of Facility Delivery	Jesse Banford	September 9, 2022
2.0	Sam EIMohtar Director of Transportation Delivery	<i>S. El Mohtar</i>	September 13, 2022
2.0	Nicole Wolfe Director of Open Space Delivery		September 14, 2022

APPROVED BY:

Version #	Approver Name and Title	Signature	Signing Date
2.0	Krista Berezowski Director, Technical Services		Sept 12, 2022
2.0	Denis Jubinville Branch Manager, Waste Services		September 15, 2022

Indigenous Acknowledgement

Edmonton is located within Treaty 6 Territory and within the Métis homelands and Métis Nation of Alberta Region 4. We acknowledge this land as the traditional territories of many First Nations such as the Nehiyaw (Cree), Denesuliné (Dene), Nakota Sioux (Stoney), Anishinaabe (Saulteaux) and Niitsitapi (Blackfoot).

The City of Edmonton owes its strength and vibrancy to these lands and the diverse Indigenous peoples whose ancestors' footsteps have marked this territory as well as settlers from around the world who continue to be welcomed here and call Edmonton home.

Together we call upon all our collective honoured traditions and spirits to work in building a great city for today and future generations.



1. Executive Summary

1.1. Waste Services IIS Infrastructure Delivery Composite Renewal

Composite profile CM-81-2045 provides funding for Waste Services capital projects intended to be delivered by Integrated Infrastructure Services (IIS) - Infrastructure Delivery Branch in the 2023-2026 capital budget cycle. The projects within this profile are aligned with the projects in composite profile [CM-81-0005 \(Waste Services IIS Infrastructure Planning and Design\)](#). The approach is consistent with the Administration's implementation of the Project Development & Delivery Model (PDDM) as well as the Capital Project Governance Policy C591¹ approved by Council in April 2017.

Adherence to both the PDDM process and Policy C591 will ensure sufficient information is prepared in advance of the capital budget process to support informed investment decisions, provide adequate resources to ensure an appropriate level of planning and design is incorporated into budget submissions, and provide an overall framework to guide management of Waste Services' capital projects.

The outcome of this profile is to provide funding for the project delivery stage, checkpoints 3, 4 and 5 (as described below), of the PDDM. The checkpoint system provides strategic controls on budget and schedule. The PDDM is a gated process (using checkpoints) for capital projects to ensure that projects are properly developed before they are funded for delivery.

While approval of this profile is necessary to determine the Waste Services capital budget and utility rates, approval of this profile does not indicate final budget or funding approval for any specific capital project.

This Capital Funding Request provides information at a design development level that pertains to the budget for projects anticipated to be delivered during the 2023-2026 budget cycle. Details of the individual projects listed in this profile, including budget and scheduling, will be further communicated once the project has reached checkpoint 3 and a detailed business case has been developed for approval from Utility Committee and Council.

The four-year capital projection for this profile is approximately \$20.5 million. A high-level list of projects is listed in Appendix B.

2. Background

In 2016, the IIS Transformation program developed the PDDM which was endorsed by Council in 2017. The PDDM is a framework to manage capital infrastructure projects and represents best practices in project management from industry and comparable municipalities. It aims to achieve the following outcomes²:

- (1) Better information to make capital investment decisions.
- (2) Improved project schedule and budget estimates through increased level of design to ensure realistic expectations are set prior to project tendering and construction.
- (3) Systematic evaluation of projects against the initial project business case and scope.

¹ <https://www.edmonton.ca/documents/PoliciesDirectives/C591.pdf>

² Integrated Infrastructure Services Report CR_4120

The PDDM flow chart is as below:



2.1. Problem / Opportunity

The current council-directed approach directs IIS to assist Waste Services in the management of capital projects in alignment with the PDDM process.

Projects included in this composite profile will address a number of Waste Services business needs such as the renewal of assets that have reached the end of their useful life, mitigation and elimination of safety and environmental risks and the need and opportunity for growth and continuous improvement.

2.2. Current Situation

Waste Services began utilizing the PDDM under the direction of Council in 2017. Under this model, funding for project delivery is budgeted in a composite profile consisting of concept estimates for projects expected to be undertaken in the capital budget cycle.

While IIS will manage the projects, Waste Services will provide subject-matter expertise as part of a project team to inform work at all checkpoints throughout the PDDM process. Waste Services will continue to follow this approach in the future.

3. Initiative Description

3.1. Initiative Description

This capital profile establishes the 2023-2026 budget for Waste Services capital projects anticipated to reach the third checkpoint in the PDDM. Separate funding for the planning and design component of the projects is under the Waste Services IIS Infrastructure Delivery composite CM-81-0005.

In accordance with Corporate thresholds, renewal projects over \$5 million and growth projects over \$2 million will be transferred to standalone profiles. Once a capital project exceeding these thresholds reaches Checkpoint 3, a detailed project-specific business case will be developed and brought to Utility Committee and Council for approval of the capital expenditure. This approval will result in a capital budget adjustment that transfers budget from this composite profile to the newly created standalone profile. Until this transaction occurs, no funds are

authorized to be spent on the delivery of the capital project. Projects under the stated thresholds will remain in and be funded from the composite profile, and will follow Council approved approval processes.

This approach is consistent with Administration's implementation of the PDDM as well as the Capital Governance Policy C591 adopted by Council in 2017.

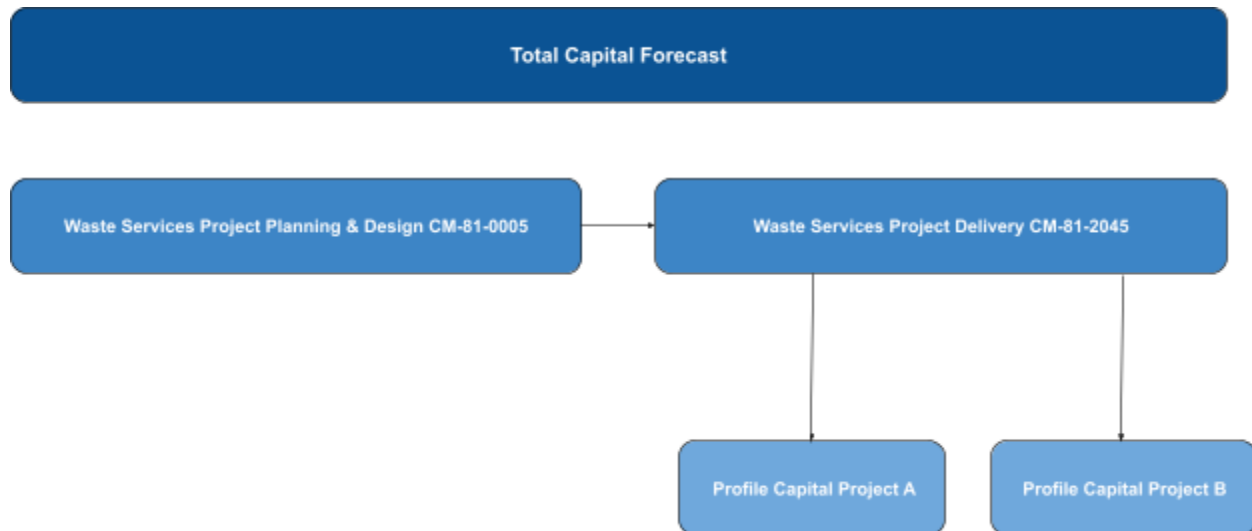

Funding in the profile will be used to support project delivery work for Waste Services' capital initiatives anticipated to be delivered in the 2023-2026 budget cycle, including but not limited to:

- Waste Water Discharge Expansion
- North Saskatchewan River (NSR) Erosion Control
- Cure Site Pad B, C and G Resurfacing
- Edmonton Waste Management Centre (EWMC) Water Distribution System Upgrades
- EWMC Site Paving
- Organics Transformer yard grading/drainage
- Organics Tip Floor Cupola
- Organics Staff Facilities Upgrades
- Organics Tip Floor Source Capture
- Organics Tip Floor Drainage Enhancement
- Integrated Process and Transfer Facility (IPTF) - Additional Metal Removal System
- Residential Transfer Station (RTS) Pad and Buildings Upgrades
- Compost School Refresh
- Kennedale Entrance Gates

For further details, please refer to project descriptions in Appendix B.

A list of required projects was submitted by the operational areas to Technical Services, indicating the project scope, schedule, risks and estimates. These were evaluated, ranked and prioritized based on the strategic and operational criteria (i.e. Project Driver and the Project Criticality) set by Technical Services. Appendix A - Waste Services Internal Project Planning and Prioritization Process outlines the prioritization process.

3.2. Urgency of Need

Effective delivery of capital projects is essential for Waste Services to achieve its commitment to providing quality sustainable waste management services to the City of Edmonton and to meet the changing needs of its customers. Projects anticipated to reach the third checkpoint in the PDDM process in this budget cycle were identified and prioritized based on strategic criteria such as environmental impact, health and safety and alignment with Branch and Corporate goals. Delivery of these concept-level projects within this profile will be fundamental to Utility operations and will help ensure continued delivery of sustainable waste collection and processing services.

As Waste Services capital budget is supported by the utility rate, business cases for both the planning and delivery phases of approved capital projects within the PDDM are required. This allows funding to be allocated to their respective composite profiles (shown below) and determine the utility rates required to support the capital budget. While approval for funding in this profile is necessary to determine capital budget and utility rates, approved funding for this profile does not indicate final budget or funding for any specific capital project.

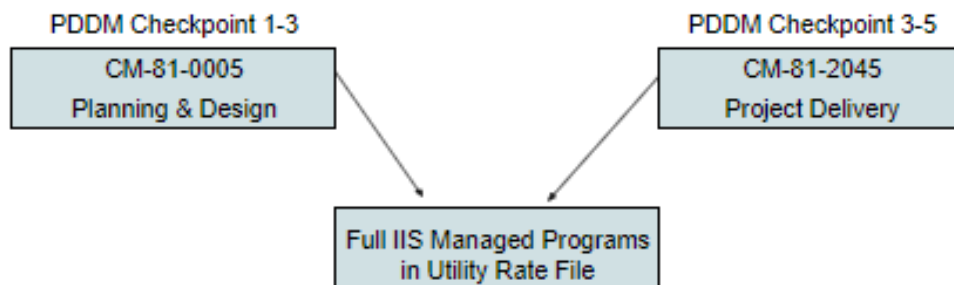

3.3. Anticipated Outcomes

In alignment with the PDDM, Waste Services will achieve the Utility’s goals through working with IIS to effectively manage the delivery of capital projects. Waste Services envisions the following outcomes:

Outcomes / Deliverables
Better information to make capital investment decisions: Through a structured and integrated process, Administration will ensure that projects identified as priorities by Waste Services receive robust evaluation of alternatives and scope identification. Through the PDDM, project maturity is regularly assessed to ensure that projects are ready to advance to the next stage of development.
Improved project schedule and budget estimates based on enhanced design details: Early investment of capital design resources allows sufficient lead time allocated on planning of the projects, thus decreasing the possibility of project scope and budget changes. Completing design work early in a project life cycle allows the greatest ability to impact overall project outcomes. Following industry best practices, a control budget and schedule will be established on the basis of a completed design to ensure realistic expectations are set prior to tendering and construction.

Systematic evaluation of project delivery against project business case and scope: Advanced project management tools support the proposed checkpoint model. Regular project status reporting and standardized documentation will further advance a system of project management accountability that builds trust in the project team's ability to effectively deliver on capital projects.

Reliable facilities and infrastructure that enable sustainable waste management in a cost-effective manner.

High levels of customer service delivered in both an efficient and effective way through leading-edge waste processing facilities that use current and emergent technology to enable high rates of diversion of waste from landfill.

Facilities that can be operated in a safe manner, protecting employees, customers and contractors.

3.4. Scope

The scope of this Capital Funding Request includes the detailed design, construction and project closeout stages, as outlined in Checkpoint 3 (Authorization for Capital Expenditure), Checkpoint 4 (Authorization for Construction expenditure), and Checkpoint 5 (Authorization for closeout) for all Capital projects led by IIS.

Checkpoint 3: This checkpoint is to verify the project has reached an appropriate level of maturity to request capital funding. Projects will be taken to a level of design that will yield more reliable estimates before being put forward for prioritization and inclusion in the Capital Budget. This is often to a Class 3 (-15% to +20%) during Design Development. The project must be developed enough to move forward and the scope must be reviewed³.

During Checkpoint 3, the project budget has been approved (led by the IIS Planning and Design Project Manager) and the transfer from the Planning and Design Branch to Delivery Branch occurs.

Checkpoint 4: Final check before the project goes to tender, to verify the project is ready to be tendered and develop a refined control budget. This will include an assessment of readiness and a final scope review. If the project is within the approved scope, schedule, and budget, an Internal Control Budget, Control Schedule and Authorization for Expenditure will result. If it is not, it will either be forwarded for a Change Request or will be sent back for revision. Approved projects are authorized to spend up to their control budget levels⁴.

Checkpoint 5: This checkpoint is to verify the project is ready for final closeout. Closeout will ensure the scope has been met satisfactorily and all closeout activities are complete⁵.

3.5. Out of Scope

The project planning and design phase of the PDDM is out of scope for this Capital Funding

³ Source: <https://sites.google.com/a/edmonton.ca/pmrg/pddm/checkpoint-3>

⁴ Source: <https://sites.google.com/a/edmonton.ca/pmrg/pddm/checkpoint-4>

⁵ Source: <https://sites.google.com/a/edmonton.ca/pmrg/pddm/checkpoint-5>

Request. The planning and design phases include Checkpoint 1 (Project initiation) and Checkpoint 2 (Authorization for Design Expenditure) and are included in a separate Capital Funding Request ([CM-81-0005, Waste Services IIS Infrastructure Planning and Design](#)).

3.6. Critical Success Factors

Critical success factors include:

- Efficient, consistent and accurate communication between Waste Services and IIS.
- Regular check-ins with the Waste Services Leadership Team to align with the strategic direction and the Utility’s goals.
- Accurate and sufficient data and cost analyses to support high level budget estimates and informed decision making for the projects.
- On time, on budget delivery of capital projects within the PDDM.

4. Strategic Alignment

This initiative contributes to the overall City of Edmonton strategic direction and to corporate and departmental business plans, including Connect Edmonton: Vision 2050. This contribution is made by demonstrating leadership in waste management and processing standards, and by increasing the diversion of residential and non-residential waste from landfill. Below are strategies, business plans and policies that support this project:

<p><i>City of Edmonton Environmental Policy C512</i></p>	<p>POLICY STATEMENT:</p> <p>The City of Edmonton, through its planning, decision-making processes, and leadership, will promote the development of an environmentally sustainable community that functions in harmony with the natural environment.</p> <p>The City of Edmonton will exercise environmental stewardship of its operations, products and services, based on its commitment to:</p> <ul style="list-style-type: none"> (a) prevent pollution; (b) continually improve its environmental performance by setting and reviewing environmental objectives and targets; and (c) meet or exceed applicable environmental legal requirements and other requirements to which it subscribes.
<p><i>Connect Edmonton: Vision 2050</i></p>	<p>This project aligns with the City’s Vision 2050 strategic plan in that by ensuring that organic/food waste is collected, processed responsibly, and the amount landfilled is minimized, Edmonton will be a healthy city, urban places will be clean, regional prosperity is increased by building a circular economy, and a low carbon future is assured.</p>

<i>Waste Services Business Plan 2022-2025</i>	The Business Plan outlines how Waste Services will continue to make transformational impacts through the 25-year Waste Strategy, provide essential service to Edmontonians while maintaining full cost recovery, and improve the employee and resident experience to support adaptation of new systems.
<i>25 Year Waste Strategy</i>	<p>“The strategy adopts a broader lens to transform the system with new focus on efforts which will emphasize waste reduction in addition to affirming a commitment to 90% diversion of single unit residential waste from landfill.”</p> <p>This project will help expand the City’s organic waste processing capabilities and contribute to the 25 Year Waste Strategy’s goal of diverting 90% of waste from landfill.</p>
<i>Waste Services Utility Fiscal Policy C558B</i>	“Customer rates will promote the efficient use of resources and be set to achieve broader social, economic, and environmental goals.”
<i>Integrated Infrastructure Services (IIS) Vision and Mission Statements</i>	<p>“We inspire trust among citizens and Council in our commitment and ability to deliver quality infrastructure.”</p> <p>We are in the business of:</p> <ul style="list-style-type: none"> ● bringing ideas to reality ● innovation and excellence ● assembling expertise ● building legacy infrastructure ● helping citizens have a better life in Edmonton ● Building a Great City

5. Context Analysis

Requested funding for project delivery for capital projects is consistent with Administration's implementation of the PDDM as well as the Capital Project Governance Policy C591 that was approved by Council in 2017.

6. Organizational Change Impact

Waste Services staff, reporting through the Technical Services section, work closely with IIS as part of a project team to plan, develop and deliver approved capital projects. No change to organization is expected.

6.1. Stakeholder Impact

Stakeholder Impact
Stakeholder 1: City of Edmonton Waste Services Branch (primary internal)
1. Well-defined and consistent process in alignment with the rest of the City

<ol style="list-style-type: none"> Enhanced consultation, recommendation and approval for Delivery checkpoints for Waste Services projects managed by IIS as part of a project team
<p>Stakeholder 2: Integrated Infrastructure Services (primary internal)</p>
<ol style="list-style-type: none"> Enhanced Project Management role for approved capital projects using input from Waste Services Improved process for capital funding for projects in the composite profile for Waste Services
<p>Stakeholder 3: City Council (primary internal)</p>
<ol style="list-style-type: none"> Increased transparency, accuracy, reliability of project schedule and budget estimates Ability to provide political direction and have access to accurate project information
<p>Stakeholder 4: City of Edmonton public (secondary external)</p>
<ol style="list-style-type: none"> Maintenance of stable/low utility rate through the effective delivery of capital projects Minimal disruption to service levels through the delivery process

6.2. Business and Operational Impact

The table below identifies the business and operational impacts for continuing to follow as recommended by Waste Services.

Business & Operational Impact & Description
<p>Waste Services (Internal)</p> <ul style="list-style-type: none"> Longer process with the addition of multiple checkpoints. Dedicated project management resources as part of a project team.
<p>Integrated Infrastructure Services, Infrastructure Delivery (internal)</p> <ul style="list-style-type: none"> Allocated resources (Project Management team) for the detailed design, construction and project closeout. Checkpoint 3/4/5 documents

Moving forward, the City of Edmonton is committed to the use of Gender-Based Analysis Plus (GBA+). Waste Services will identify root causes on any issues that may arise, use an evaluation approach, consider the inputs from affected stakeholders (e.g. people with disabilities, indigenous people, seniors, etc.), and develop and implement an action plan for safety, diversity and inclusivity issues using GBA+. Waste Services acknowledges that GBA+ is an equity assessment tool that allows for holistic consideration of the need for use, and impact of, this Capital Funding Request and that staff are trained in the GBA+ process.

7. Benefits / Costs

7.1. Tangible Benefits

The following tangible benefits will be realized by following this approach:

- Improved operational efficiency of facilities, infrastructure and process equipment.
- Reduction in safety-related incidents.
- Long term savings due to process and operational improvements.
- Meet or exceed environment compliance requirements.

7.2. Intangible Benefits

The following intangible benefits will be realized by following this approach:

- Improved efficiency in project management.
- Increased adherence to budget and schedule estimates.
- Improved ability to forecast capital expenditure thus allowing for more certainty in utility rates for the budget cycle.
- Structured process to evaluate readiness, scope and prioritization.
- Increased project accountability, awareness and controls.
- Closer integration of City departments.

7.3. Costs

REQUEST	2023	2024	2025	2026	TOTAL PROFILE BUDGET
Capital Budget Request	\$1,950,330	\$7,123,355	\$6,325,801	\$5,102,751	\$20,502,237

Note that the above costs do not include planning and design, which are requested in a separate Capital Funding Request (Waste Services IIS Infrastructure Planning and Design Composite Capital Funding Request). For a listing of the projects included under the above estimates, please refer to Appendix B.

Please refer to Appendix C for the Financial Analysis Summary. The table and graph demonstrating the revenue requirement related to these capital costs **include both** planning and design and project delivery to show the full impact of the projects.

7.4. Assumptions

- Projects in this composite profile have allocated budget amounts that are based on high-level project estimates. The actual costs of the approved capital projects may vary once the design stage is completed by IIS.
- All of the proposed projects in this composite profile have been prioritized based on the approval of Waste Services proposed program changes pending decision of Utility Committee and Council.
- Projects listed in this Capital Funding Request are at a concept level only. The individual

project details, budget and schedule will be outlined in a full business case to be presented to Utility Committee and Council for funding.

- Projects within this profile will only proceed with approved funding available for the planning and design phase under composite CM-81-0005.

8. Resourcing

All capital projects in this composite profile will be managed by the Infrastructure Delivery Branch within IIS. Where outside resources are required, the tender process and external vendor relationship will be managed by IIS. Subject-matter expertise will be contributed by Waste Services and Engineering Services to the project teams; there will be no addition to the current approved Waste Services FTE complement.

9. Key Risk(s) and Mitigation Strategy

RISK(S)	IMPACT	MITIGATION STRATEGY
Projects scheduled for delivery may be changed or canceled after the checkpoint 3 business case if the project planning and design does not meet the intended outcome.	Low	<ul style="list-style-type: none"> • Enhanced project communication between IIS and Waste Services at Planning and Development level; increased collaboration and shared decision-making between IIS and Waste Services.
Emerging priorities may cause delays for projects scheduled to proceed to delivery stage	Low	<ul style="list-style-type: none"> • Profile project list is concept level only, allowing for allocation changes, however in order to foster continuity of information, project team will be informed of updated Branch priorities • Waste Services and IIS through project teams will have regular meetings to ensure integration and implementation of planned projects as well as responding to emergent projects.

10. Conclusion and Recommendations

10.1. Conclusion

This capital funding request outlines the overall capital budget requirement for capital projects anticipated to move into the Project Delivery phase of the PDDM for the 2023-2026 budget cycle. These capital projects are proposed to receive a budget under the composite profile, Waste Services Project Delivery (IIS Managed) CM-81-2045, for a total capital budget of approximately \$20.5 million.

Projects moving into the delivery phase will be allocated budget through a detailed project level

business case and a formal Checkpoint 3 request pending approval from Utility Committee and Council. In accordance with Corporate thresholds, renewal projects over \$5 million and growth projects over \$2 million will be transferred to standalone profiles. Projects under these thresholds will remain in the composite profile. Adherence with the PDDM is expected to improve project schedule adherence and improve budget estimates through an increased level of design to ensure realistic expectations are set prior to project tendering and construction.

10.2. Recommendations

Waste Services recommends continuing to follow the PDDM and approve funds for the project delivery phase for capital projects managed by IIS. This will lead to control on the project scope, schedule, budget and delivery in alignment with IIS PDDM.

10.3. Project Responsibility and Accountability

The project sponsor and budget owner for all approved capital projects in this composite profile is the Branch Manager of Waste Services. The delivery of capital projects within this composite and all standalone profiles will be overseen by the Branch Manager of Infrastructure Delivery, IIS. Individual projects are led by Project Managers within Infrastructure Delivery.

11. Implementation Approach

This composite capital profile (CM-81-2045) sets the 2023-2026 capital budget for Waste Services for capital projects that are anticipated to reach the third checkpoint in the PDDM process within the budget cycle. Once a capital project reaches Checkpoint 3, a detailed project-specific business case will be developed and brought to Utility Committee and Council for approval.

This approval will result in a capital budget adjustment that transfers budget from this profile to the newly created standalone profile.

From that point, respective project managers from IIS will use approved funds in the standalone profiles for project execution, which will be governed by the gated project management system within the PDDM.

12. Review and Approval Process

The following review and approval process was followed for this business case:

Review Step	Reviewer
Review 1	Team Lead of Technical Services, General Supervisor of Business Integration Integration, General Supervisor of CS, General Supervisors of SWPS, General Supervisors of Technical Services, Program Manager of IIS FID, General Supervisor of IIS FID, and Senior Accountant of Financial Services
Review 2	Director of Finance, Director of Business Integration, Director of CS, Director of Technical Services (Final Approver), Director of SWPS, and Director of IIS FID

Review 3	Branch Manager Waste Services (Final Approver)
Review 4	Utility Advisor
Review 5	Utility Committee report presented

13. Appendices

Appendix A: Waste Services Internal Project Planning and Prioritization Process

Appendix B: Waste Services (IIS Managed) Delivery Project Descriptions - 2023-2026

Appendix C: Financial Analysis Summary - Waste Services (IIS Managed) Delivery composite profile

Appendix A: Waste Services Internal Project Planning and Prioritization Process

The following outlines the Project Prioritization process:

1. Capital project needs are identified from all sections of the Utility and listed on the [2023-26 Waste Services Capital Planning Sheet](#).
2. Each project is scored based on the Project Driver and the Project Criticality. See tables 1 and 2 below for details. Total project score for each project is calculated by multiplying the driver and criticality scores.
3. Projects are then prioritized based on the total scores.
4. Projects are recommended based on prioritization with budget estimates.
5. Waste Services Leadership Team (WSLT) reviews and approves the final list.
6. Planning, documentation, and approval process for each individual project follows the approved [Waste Services Project Management Framework](#).
7. Re-prioritization exercises occur on a bi-annual basis for possible adjustments according to Branch priority.

Table 1: Project Driver

Project Driver (score)						
Regulatory / Compliance (5)	Safety / Environmental Enhancement (5)	Asset Renewal/Up grade (4)	Business Need / Growth (3)	Strategic / Corporate Goal (3)	Process / Operational Improvement (3)	Other (3)

Table 2: Project Criticality

Project Criticality (score)		
Critical - cannot be deferred (3)	Very Important - cannot be deferred (2)	Can be deferred (1)

Appendix B: Waste Services (IIS Managed) Delivery Project Descriptions - 2023-2026

The following table shows projects anticipated to be undertaken for this budget cycle:

Project	Description	Project Driver / Objective
Waste Water Discharge Expansion	Design and construction of a pump station and associated gathering infrastructure to connect the EWMC groundwater diversion system and sanitary infrastructure to the EPCOR wastewater treatment plant.	Regulatory/Compliance
North Saskatchewan River (NSR) Erosion Control	Design and construction of North Saskatchewan River bank stabilization to reduce erosion and slope stability issues adjacent to the Clover Bar Landfill.	Safety/Environmental Enhancement
Cure Site Pad B, C and G Resurfacing	The project supports the renewal of the existing cure site. The current site is approaching the end of its life cycle and major capital renewal work needs to be done with regard to the site liner and site drainage.	Asset Renewal/Upgrade
EWMC Water Distribution System Upgrades	Implementation of recommended water distribution upgrades to meet fire flow and operational requirements at the EWMC.	Safety/Environmental Enhancement
EWMC Site Paving	Project supports new paving requirements throughout the EWMC.	Asset Renewal/Upgrade
Organics Transformer Yard Grading	Project supports civil design and construction to allow for adequate drainage in an area with high voltage electrical equipment.	Safety/Environmental Enhancement
Organics Tip Floor Cupola	Project supports modification to the Organics tip floor building allowing for proper and safe removal of the trommel screen from its drum without removing the entire trommel from its location in the process.	Asset Renewal/Upgrade
Organics Staff Facilities Upgrades	Needs analysis for ADF/Organics office, locker room and control room space, and staff walkways. Project delivery to be included.	Asset Renewal/Upgrade: Improving the staff facilities for the ADF.
Organics Tip Floor Source Capture	Needs analysis and implementation of dust collection in order to meet environmental requirements.	Safety/Environmental Enhancement

Organics Tip Floor Drainage Enhancement	Project supports needs analysis and modification to the Organics Tip Floor to allow for adequate drainage.	Business Need/Growth
IPTF - Additional metal removal system	Project will deal with the analysis of current metal removal and improvement options	Process/Ops Improvement
RTS pad and buildings upgrade	Project supports the upgrade and replacement of aging RTS buildings	Asset Renewal/Upgrade
Compost School Refresh	Develop and implement a master plan for scaled improvements to Compost School, located beside the John Janzen Nature Centre (7000 143 St NW).	Strategic / Corporate Goal
Kennedale Entrance Gates	Replacement of manual gates with automated gates to provide adequate security at the Kennedale Waste Collections Site.	Safety/Environmental Enhancement

Appendix C: Financial Analysis Summary - Waste Services (IIS Managed) Design and Delivery composite profiles

Project Title: IIS Project Delivery	Follow PDDM for Design and Delivery
Total Capital Cost	(\$20,502,238)
Total Revenues	\$0
Total Operating and Maintenance Costs	\$0
Total Lease Costs	\$0
Project Net Inflows (Outflows)	(\$20,502,238)
WACC Discount Rate	6.28%
Project Costs (Present Value)	(\$16,382,962)

Note: Capital projects within this profile are presented at a concept level and as such, associated operating and maintenance costs are not identified at this time. These costs for each project will be considered and included in the individual business cases at Checkpoint 3.

The following table and graph demonstrate the cumulative present value of the revenues that must be realized through annual rate collection to support the project costs. This includes interest and amortization expenses over the project lifecycle. Please note that these costs **include** the IIS managed Planning and Design in order to demonstrate the full project spending for revenue requirement calculation purposes.

Project Title: IIS Planning & Design and Project Delivery
Cumulative Present Value of Revenue Requirement

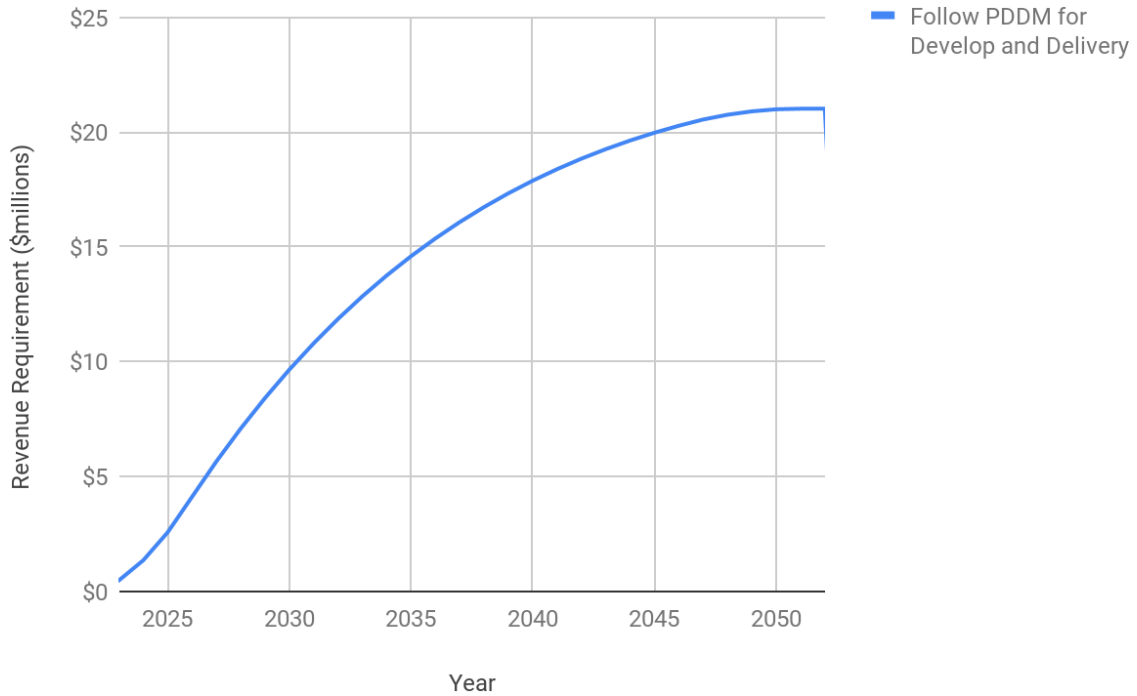

Year	Calendar Year	Follow PDDM for Develop and Delivery
0	2022	\$0
1	2023	\$464,644
2	2024	\$1,340,801
3	2025	\$2,554,621
4	2026	\$4,099,414
5	2027	\$5,641,775
6	2028	\$7,075,872
7	2029	\$8,408,254
8	2030	\$9,645,081
9	2031	\$10,792,148
10	2032	\$11,854,908
11	2033	\$12,838,487

12	2034	\$13,747,711
13	2035	\$14,587,116
14	2036	\$15,360,971
15	2037	\$16,073,292
16	2038	\$16,727,854
17	2039	\$17,328,210
18	2040	\$17,877,701
19	2041	\$18,379,470
20	2042	\$18,836,471
21	2043	\$19,251,485
22	2044	\$19,627,127
23	2045	\$19,965,855
24	2046	\$20,269,981
25	2047	\$20,541,681
26	2048	\$20,750,185
27	2049	\$20,897,523
28	2050	\$20,987,530
29	2051	\$21,012,147
30	2052	\$21,012,147

CAPITAL PROFILE REPORT

PROFILE NAME: **WASTE SERVICES IIS INFRASTRUCTURE DELIVERY**

**RECOMMENDED
FUNDED**

PROFILE NUMBER: **CM-81-2045**

PROFILE STAGE: **Approved**

DEPARTMENT: **Integrated Infrastructure Services**

PROFILE TYPE: **Composite**

LEAD BRANCH: **Infrastructure Planning and Design**

LEAD MANAGER: **Pascale Ladouceur**

PARTNER: **Waste Services**

PARTNER MANAGER: **Denis Jubenville**

BUDGET CYCLE: **2023-2026**

ESTIMATED START: **January, 2023**

ESTIMATED COMPLETION: **December, 2026**

Service Category: **Utilities**

Major Initiative:

GROWTH
50

RENEWAL
50

PREVIOUSLY APPROVED:	-
BUDGET REQUEST:	20,502
TOTAL PROFILE BUDGET:	20,502

PROFILE DESCRIPTION

The composite profile CM-81-2045 provides a level of funding for Waste Services capital projects that are intended to be delivered by Integrated Infrastructure Services - Infrastructure Delivery Branch in the 2019 - 2022 capital budget cycle. The approach is consistent with Administration's implementation of the Project Development & Delivery Model (PDDM) as well as the Capital Project Governance Policy C591 that was adopted by Council in April 2017.

Adherence to both the PDDM process and Policy C591 will ensure that sufficient information is prepared in advance of the capital budget process to support informed investment decisions, provide adequate resources for planning and design to ensure appropriate level of planning and design is incorporated into budget submissions and provide an overall framework to guide the management of Waste Services' capital projects.

As PDDM has previously been adopted by Council, this capital funding request establishes funding prioritization for Waste Services projects anticipated to enter the project delivery stage within a checkpoint system with strategic controls on budget and schedule. The PDDM approach is a gated process for capital projects to ensure that projects are properly developed before they are funded for delivery.

While approval for funding in this profile is required to establish the initial 2023-2026 capital budget and projected utility rate increases over the 4 year period, approved funding for this profile does not indicate final budget or funding for any specific capital project.

This capital funding request provides information at a concept level that pertains to the budget for projects that are anticipated to be delivered during the 2023-2026 budget cycle. Details of the individual projects listed in this profile, including budget and scheduling will be further disclosed once the project has reached checkpoint 3 and a detailed business case has been developed for approval from Utility Committee and Council.

This profile requires funding for Waste Services capital projects that are intended to be delivered by Integrated Infrastructure Services - Infrastructure Delivery Branch in the 2023-2026 capital budget cycle. The four year capital projection for this profile is approximately \$96 million. A high level list of projects and estimated budget allocations is listed in Appendix A.

PROFILE BACKGROUND

The PDDM is a framework to manage all capital infrastructure projects and represents the best practices in project management from the industry and comparable municipalities. It aims to achieve the following outcomes:

- (1) Better information to make capital investment decisions
- (2) Improved project schedule and budget estimates through increased level of design to ensure realistic expectations are set prior to project tendering and construction
- (3) Systematic evaluation of projects against the initial project business case and scope.

This profile sets the 2023-2026 budget for Waste Services for projects that are anticipated to reach checkpoint 3 in the PDDM process. Once a project reaches this stage, a detailed standalone business case will be developed and brought to Utility Committee and Council for approval.

This approval will result in a capital budget adjustment that transfers budget from this profile to the newly created standalone profile. Until this transaction occurs, no funds are authorized to be spent on the delivery of a capital project.

PROFILE JUSTIFICATION

Urgency of Need

The need to effectively deliver capital projects is essential for Waste Services to achieve its commitment to deliver quality sustainable waste management services to the City of Edmonton as well as effectively meet the changing needs of its customers. Projects that are anticipated to reach the third checkpoint in the PDDM process within this budget cycle have been identified and prioritized based on strategic criteria such as environmental impact, health and safety and alignment with Branch and Corporate goals. Delivery of these concept level projects within this profile will be fundamental to Branch operations and will help to ensure continued delivery of sustainable waste collection and processing services.

As Waste Services capital budget is supported by the utility rate, business cases for both planning and delivery phases of approved capital projects within the PDDM approach are required in order to have funds allocated to the composite profile and determine the utility rates required to support the capital budget. While approval for funding in this profile is necessary to determine capital budget and utility rates, approved funding for this profile does not indicate final budget or funding for any specific capital project.

Anticipated Outcomes

In alignment with the PDDM approach, Waste Services will realize the achievement of branch goals through working with Integrated Infrastructure Services to effectively manage the delivery of capital projects. Effective asset management will ensure that Waste Services has the resources to achieve its objectives by aligning its vision, mission and strategic plan with daily activities to achieve its goals. Waste Services envisions the following outcomes:

Better information to make capital investment decisions: Through a structured and integrated process, administration will ensure that projects identified as priorities by Waste Services receive robust evaluation of alternatives and scope identification. Through the PDDM process, project maturity is regularly assessed to ensure that projects are ready to advance to the next stage of development.

Improved project schedule and budget estimates: Following industry best practices, a control budget and schedule is established on the basis of a completed design to ensure realistic expectations are set with IIS prior to tendering and construction.

Reliable facilities and infrastructure that enable sustainable waste management in a cost effective manner.

High levels of customer service delivered in both an efficient and effective way through leading-edge waste processing facilities that use current and emergent technology to enable high rates of diversion of waste from landfill.

Facilities that can be operated in a safe manner, protecting employees, customers and contractors.

Capitalize on opportunities to reduce cost to operate and process waste in an environmentally and fiscally responsible way.

Scope

The scope of this business case includes the detailed design, construction and project closeout stages, which subsumes work after completing Checkpoint 3 through Checkpoint 4 (Authorization for Construction expenditure) and Checkpoint 5 (Authorization for closeout) for all authorized Capital projects being led by IIS on behalf of Waste Services.

Checkpoint 4: Final check before the project goes to tender, to verify the project is ready to be tendered and develop a refined control budget. This will include an assessment of readiness and a final scope review. If the project is within the approved scope, schedule, and budget, an Internal Control Budget, Control Schedule and Authorization for Expenditure will result. If it is not, it will either be forwarded for a Change Request or will be sent back for revision. Approved projects are authorized to spend up to their control budget levels.

Checkpoint 5: This checkpoint is to verify that the project is ready for the final closeout within Integrated Infrastructure Services. Closeout will ensure that the scope has been met satisfactorily and that all closeout activities have been completed.

Out of Scope

Project planning and design phase of the PDDM approach is out of scope for this business case. (This includes Checkpoint 1 (Project initiation), Checkpoint 2 (Authorization for Design Expenditure) and Checkpoint 3 (Approval for Capital Budget) of the PDDM approach.

Critical Success Factors

Critical success factors include:

Efficient, consistent and accurate communication between Waste Services and IIS

Regular check-ins with the Waste Services Branch Leadership team to align with the strategic direction and branch goals

Accurate and sufficient data and cost analyses to support high level budget estimate and informed decision makings for the projects

On time, on budget delivery of capital projects within the PDDM approach.

STRATEGIC ALIGNMENT

Projects following the PDDM approach for Waste Services align with the following strategic goals of City of Edmonton:

Healthy City/Urban Places/Regional Prosperity/Climate Resilience

City of Edmonton's Waste Management Policy C527 and Waste Management Utility Fiscal Policy C558A as well as the Capital Project Governance Policy C591. This profile also aligns with Waste Services integrated 25-year strategic outlook that will help to ensure Edmontonians receive maximum economic and environmental benefits while minimizing the cost increases of managing solid waste.

ALTERNATIVES CONSIDERED

This is a capital funding request and does not present any alternatives for consideration. In this process, multiple checkpoints occur prior to the budget approval for the delivery of a single project, including a detailed business case, ensuring that budget and schedule adjustments may be made prior to the tender process.

COST BENEFITS

Tangible: Improved efficiency in project management Increased adherence to budget and schedule estimates Improved ability to forecast capital expenditure thus allowing for more certainty in utility rates Intangible: Structured process to evaluate readiness, scope and prioritization Increased project accountability Increased project awareness and controls Closer integration of City departments More efficient and consistent procurement process.

KEY RISKS & MITIGATING STRATEGY

RISK- PDDM is a gated process and the additional steps required in this new process may increase timelines or compromise scheduled completion dates

MITIGATION- Waste Services will work closely on the project team with IIS and other parties to ensure project planning process is started in advance, timely review and approval is occurring and schedules are adhered to.

RISK-Emerging priorities may cause delay

MITIGATION-The conceptual project list can be changed. Regular project team meetings will ensure integration & implementation of planned projects & respond to emergent projects.

RESOURCES

Projects will be managed by the Infrastructure Delivery Branch. Where outside resources are required the tender process will be managed by IIS. Subject matter expertise will be contributed by Waste Services from current staff complement. There will be no addition to the current approved FTE required.

CONCLUSIONS AND RECOMMENDATIONS

The capital funding request outlines the overall budget requirement for projects anticipated to move into the Project Delivery phase for the 2023 -2026 budget cycle for a total of approximately \$20,502,237. Projects moving into the delivery phase will have detailed business cases and budget adjustment will be requested from Utility Committee and Council. Waste Services recommends continuing to follow the PDDM approach and release funds for project delivery phase for all capital projects handled by IIS. This will lead to higher control on the scope, schedule, budget and delivery.

CAPITAL PROFILE REPORT

PROFILE NAME: **Waste Services IIS Infrastructure Delivery**
 PROFILE NUMBER: **CM-81-2045**
 BRANCH: **Infrastructure Planning and Design**

RECOMMENDED FUNDED

PROFILE TYPE: **Composite**

CAPITAL BUDGET AND FUNDING SOURCES (000's)

APPROVED BUDGET		Prior Years	2022	2023	2024	2025	2026	2027	2028	2029	2030	Beyond 2030	Total
	Approved Budget												
	Original Budget Approved	-	-	-	-	-	-	-	-	-	-	-	-
	Current Approved Budget	-	-	-	-	-	-	-	-	-	-	-	-

BUDGET REQUEST	Budget Request	-	-	1,950	7,123	6,326	5,103	-	-	-	-	-	20,502
	Revised Funding Sources (if approved)												
	Self-Liquidating Debentures	-	-	1,950	7,123	6,326	5,103	-	-	-	-	-	20,502
	Requested Funding Source	-	-	1,950	7,123	6,326	5,103	-	-	-	-	-	20,502

REVISED BUDGET (IF APPROVED)	Revised Budget (if Approved)	-	-	1,950	7,123	6,326	5,103	-	-	-	-	-	20,502
	Requested Funding Source												
	Self-Liquidating Debentures	-	-	1,950	7,123	6,326	5,103	-	-	-	-	-	20,502
	Requested Funding Source	-	-	1,950	7,123	6,326	5,103	-	-	-	-	-	20,502

CAPITAL BUDGET BY ACTIVITY TYPE (000's)

REVISED BUDGET (IF APPROVED)	Activity Type	Prior Years	2022	2023	2024	2025	2026	2027	2028	2029	2030	Beyond 2030	Total
		Construction	-	-	1,950	7,123	6,326	5,103	-	-	-	-	-
	Total	-	-	1,950	7,123	6,326	5,103	-	-	-	-	-	20,502

OPERATING IMPACT OF CAPITAL

Type of Impact:

Branch:																
	Rev	Exp	Net	FTE	Rev	Exp	Net	FTE	Rev	Exp	Net	FTE	Rev	Exp	Net	FTE
Total Operating Impact	-	-	-	-	-	-	-	-	-	-	-	-	-	-	-	-

CAPITAL PROFILE REPORT

PROFILE NAME: Waste Services IIS Infrastructure Delivery

PROFILE NUMBER: CM-81-2045

BUDGET CYCLE: 2023-2026

Project Number	Project Name	Description	Percentage Funded
230001	Waste Water Discharge Expansion	Waste Water Discharge Expansion	100
230002	North Saskatchewan River (NSR) Erosion Control	North Saskatchewan River (NSR) Erosion Control	100
230003	Cure Site Pad B, C and G Resurfacing	Cure Site Pad B, C and G Resurfacing	100
230004	Edmonton Waste Management Centre (EWMC) Water Distribution System Upgrades	Edmonton Waste Management Centre (EWMC) Water Distribution System Upgrades	100
230005	EWMC Site Paving	EWMC Site Paving	100
230006	Organics Transformer yard grading/drainage	Organics Transformer yard grading/drainage	100
230007	Organics Tip Floor Cupola	Organics Tip Floor Cupola	100
230008	Organics Staff Facilities Upgrades	Organics Staff Facilities Upgrades	100
230009	Organics Tip Floor Source Capture	Organics Tip Floor Source Capture	100
230010	Organics Tip Floor Drainage Enhancement	Organics Tip Floor Drainage Enhancement	100
230011	Integrated Process and Transfer Facility (IPTF) - Additional Metal Removal System	Integrated Process and Transfer Facility (IPTF) - Additional Metal Removal System	100
230012	Residential Transfer Station (RTS) Pad and Buildings Upgrades	Residential Transfer Station (RTS) Pad and Buildings Upgrades	100
230013	Compost School Refresh	Compost School Refresh	100
230014	Kennedale Entrance Gates	Kennedale Entrance Gates	100



Waste Services Waste Containers Composite Capital Funding Request 2023-2026

City Operations | Waste Services
City of Edmonton

Capital Profile: CPP#: CM-81-2005

Project Number: CP# / OP#: TBD

Profile Owner: Krista Berezowski

Profile Sponsor: Denis Jubinville

Version #: 2.0

Date published: August 31, 2022

page intentionally left blank

TABLE OF CONTENTS

Change History	5
Document Approval	5
Indigenous Acknowledgement	7
Executive Summary	8
Waste Services Waste Container Composite	8
Background	8
Problem / Opportunity	8
Current Situation	8
Initiative Description	9
Initiative Description	9
Urgency of Need	9
Anticipated Outcomes	9
Scope	10
Out of Scope	10
Critical Success Factors	10
Strategic Alignment	10
Context Analysis	12
Organizational Change Impact	13
Stakeholder Impact	13
Business and Operational Impact	14
Benefits / Costs	14
Tangible Benefits	14
Intangible Benefits	14
Costs	15
Assumptions	15
Resourcing	15
Key Risk(s) and Mitigation Strategy	15
Conclusion and Recommendations	16
Conclusion	16
Recommendations	16
Project Responsibility and Accountability	16
Implementation Approach	16
Review and Approval Process	16
Appendices	17

Appendix A: Financial Analysis Summary	18
Appendix B: Waste Container Type and Budget	20

Change History

Version #	Date	Author	Description
1.0	08/17/22	Lena Aitken	First Draft
2.0	08/31/22	Lena Aitken	Second Draft

Document Approval



SUBMITTED BY:

Version #	Submitter Name	Title	Submission Date
2.0	Lena Aitken	Senior Project Engineer	August 31, 2022

REVIEWED BY:

Version #	Reviewer Name and Title	Signature	Signing Date
2.0	Neil Kjelland Director, Sustainable Waste Processing	Neil Kjelland	Sep 12, 2022
2.0	Chris Fowler Director, Collections Services	Chris Fowler	Sept 2, 2022
2.0	Jodi Goebel Director, Business Integration	Jodi Goebel	Sept 9, 2022
2.0	Keith Knoblauch Operational Controller, Business Financial Analytics	Keith Knoblauch	Sep 13, 2022
2.0	Crystal Wood Communications Advisor	Crystal Wood	Aug 31, 2022

APPROVED BY:

Version #	Approver Name and Title	Signature	Signing Date
2.0	Krista Berezowski Director, Technical Services		Sept 13, 2022
2.0	Denis Jubinville Branch Manager, Waste Services		Sept 15, 2022

Indigenous Acknowledgement

Edmonton is located within Treaty 6 Territory and within the Métis homelands and Métis Nation of Alberta Region 4. We acknowledge this land as the traditional territories of many First Nations such as the Nehiyaw (Cree), Denesuliné (Dene), Nakota Sioux (Stoney), Anishinaabe (Saulteaux) and Niitsitapi (Blackfoot).

The City of Edmonton owes its strength and vibrancy to these lands and the diverse Indigenous peoples whose ancestors' footsteps have marked this territory as well as settlers from around the world who continue to be welcomed here and call Edmonton home.

Together we call upon all our collective honoured traditions and spirits to work in building a great city for today and future generations.



Executive Summary

1.1. Waste Services Waste Container Composite

The Waste Services Waste Container Capital Profile CM-81-2005 recommends funding for the purchase of steel bins (front load, side load, and roll-off waste containers), litter baskets, plastic bins, curbside carts, and associated accessories used in Waste Services' waste collection and drop-off programs. The purchase of waste containers supports Edmonton's urban growth as well as the replacement of waste containers that have reached the end of their service life or are beyond economically feasible repair. This profile will also support the growth of the curbside Source Separated Organics (SSO) program (i.e. curbside carts).

The four-year total capital projection is approximately \$16.1 million.

2. Background

Waste Services has an inventory of over 540,000 waste containers (bins and carts) that requires replacement at the end of life cycle. Table 1 provides a breakdown of the container types. In addition, new containers are required to meet the growth demands for various waste collection and drop-off programs across the City. Waste containers for both replacement and growth need to be purchased on a regular basis to maintain an adequate inventory and availability of stock to meet demand.

2.1. Problem / Opportunity

As Waste Services plans for future growth and replacement of older or damaged waste containers, there is an opportunity to adopt a proactive, long-term purchase planning approach to mitigate external risk factors. Waste containers are subject to significant purchase risk, including global supply chain risks, uncertainty in the price of raw materials (steel, plastics, etc.) to build containers, and potential for changes to existing international trade agreements. Access to the required capital through the capital planning horizon enables mitigation of these risks and a level of certainty in the planning and purchase of waste containers.

2.2. Current Situation

Waste Services provides waste collection and drop-off services in Edmonton. Part of this service includes the provision of waste containers, which are used to temporarily store garbage, food scraps, or recycling waste at various locations such as residences, Eco-Stations, Recycling Depots, the Edmonton Waste Management Centre (EWMC), etc. Waste Services currently has the following container asset inventory, inclusive of those currently in use and in storage:

Table 1: Waste Container Inventory

Waste Containers Type	Approximate total number of bins and carts (in use and in storage), as of August 2022 ¹	Programs
Steel Bins (front load, side load, roll-off containers)	11,500	Multi-Family refuse and recycling collection programs, Community recycling depot, Eco Stations, Big bin events, and EWMC
Litter Baskets	1900	Public Space Waste Container Program
Plastic Bins	270	Multi-family refuse and recycling programs
Curbside carts (for example Green and Black Carts)	530,000	Curbside Collection Program (started in 2019. Has 530,000 in inventory as of 2022)

Waste Services operates a waste container maintenance program that receives containers for service, minor repairs, replacement of parts and accessories, and painting when required. Older containers that are deemed to be structurally sound are repaired to extend their service life. Containers that are severely damaged or have structural failures require replacement. Waste containers have an average expected asset life of 15 years. The average age of the existing waste containers, except the curbside carts recently put into service through the Edmonton Cart Rollout, will be 13 years at the end of 2022. Regular repairs is considered to be an operating expense and is not included in the scope of this capital funding request.

3. Initiative Description

3.1. Initiative Description

The purchase of new waste containers and associated accessories is required for continued waste collection in Edmonton. The City owns different types of waste containers for various collection and drop-off services as listed in Table 1. New waste containers are required for the replacement of in-service containers that have either reached the end of their useful life (capital expense) or are damaged beyond economically feasible repair (operating expense), and also for new developments throughout the budget cycle.

Containers are purchased each year to ensure an even expenditure pattern and maintain the desired service level of containers. The expected outcome is to continue to provide efficient

¹ Waste Container Inventory

collection service to Edmontonians in a safe, environmentally and economically sustainable manner.

The \$16.1 million requested in this profile considers forecasted demand for replacement and planned urban growth, including impacts related to global supply chain issues and resulting increases in commodity pricing. It also includes approximately \$4.6 million of curbside containers that were previously included under the Source Separated Organics standalone profile in 2019-2022.

3.2. Urgency of Need

Waste Services retains a limited quantity of new containers in stock to meet urgent demands and ensure uninterrupted operation, however, this capital funding profile is used to purchase the required inventory to account for forecasted growth and lifecycle replacement of container assets.

Without support for this composite profile, container availability would be severely undersupplied leading to negative impacts on the environment and Waste Services programs and targets. The Utility would also experience higher risk of failure and maintenance costs of existing containers beyond their useful lives, leading to inefficiencies in waste collection services and potential safety issues. It is critical that this profile is approved to ensure continuity of container and accessory replacement and availability of stock.

3.3. Anticipated Outcomes

The anticipated outcomes of the purchase of new waste containers include asset integrity, system reliability, efficiency, and enhanced safety:

Outcomes / Deliverables
Maintain high levels of customer service and realize process efficiencies through the use of sector-appropriate waste containers.
Maintain an adequate inventory of waste containers to meet the service demands for growth and replacement of containers at or near the end of their life cycle.
Capitalize on opportunities to reduce operational costs.

3.4. Scope

The scope of this business case includes the purchase of waste containers for both replacement of inventory stock and forecasted growth in the 2023-2026 capital budget cycle. Included in this are the following types of waste containers:

1. Front load steel containers
2. Front load plastic containers
3. Side load steel containers
4. Roll-off steel containers

5. Litter baskets
6. Curbside carts

3.5. Out of Scope

The following containers are out of scope for this business case:

1. Private sector containers
2. Edmonton Transit Services waste containers/baskets
3. Parks and Roads Services waste containers/baskets
4. Eco Station containers which are provided by on-site contractors
5. Additional waste containers required for the source separation collection program for multi-unit residents receiving communal bin collection. These containers needed in 2023-2026 will be included in a separate stand-alone profile.

3.6. Critical Success Factors

Critical success factors include:

- Timely acquisition of required containers to ensure an adequate stock of waste containers and maintain existing service levels.
- Timely procurement process to mitigate risks associated with purchase of waste containers. The majority of containers are fabricated metal or plastic products, which are directly impacted by local labour rates, global metal/plastic prices, global supply chain challenges, and global trade tariffs.
- Adherence to container maintenance program plan.

4. Strategic Alignment

Waste Services is committed to advancing Council's vision and goals. This capital funding request contributes to the overall strategic direction of City Council and the goals and policies of the corporate strategic documents listed in the table below. This contribution is made by demonstrating leadership in waste management and waste collection standards, and by increasing the diversion of residential and non-residential waste from landfill.

<p>City of Edmonton Environmental Policy C512²</p>	<p>POLICY STATEMENT:</p> <p>The City of Edmonton, through its planning, decision-making processes, and leadership, will promote the development of an environmentally sustainable community that functions in harmony with the natural environment.</p> <p>The City of Edmonton will exercise environmental stewardship of its operations, products and services, based on its commitment to:</p> <ul style="list-style-type: none"> (a) prevent pollution; (b) continually improve its environmental performance by setting and reviewing environmental objectives and targets; and (c) meet or exceed applicable environmental legal requirements and other requirements to which it subscribes.
<p>Connect Edmonton: Vision 2050³</p>	<p>This project aligns with the City’s Vision 2050 strategic plan in that, along with other Waste Services initiatives, waste is collected, processed responsibly, and the amount landfilled is minimized. Edmonton will be a healthy city, urban places will be clean, regional prosperity is increased by contributing to a circular economy, and a low carbon future is assured.</p>
<p>Waste Services Business Plan 2022-2025⁴</p>	<p>The Business Plan outlines how Waste Services will continue to make transformational impacts through the 25-Year Waste Strategy, provide essential service to Edmontonians while maintaining full cost recovery, and improve the employee and resident experience to support adaptation of new systems.</p>
<p>25-Year Waste Strategy⁵</p>	<p>“The strategy adopts a broader lens to transform the system with new focus on efforts which will emphasize waste reduction in addition to affirming a commitment to 90% diversion of single unit residential waste from landfill.”</p> <p>This project will enable the efficient collection of waste, while supporting the City’s organic waste processing capabilities and contribute to the 25-Year Waste Strategy’s goal of diverting 90% of waste from landfill.</p>

² COE Environmental Policy C512

³ ConnectEdmonton

⁴ Waste Services Business Plan 2022-2025

⁵ 25-Year Waste Strategy

Waste Services Utility Fiscal Policy C558B ⁶	<p>“Customer rates will promote the efficient use of resources and be set to achieve broader social, economic, and environmental goals.”</p> <p>This project will help to achieve broader social, economic, and environmental goals by enabling the efficient collection of waste.</p>
---	--

5. Context Analysis

The City of Edmonton is unique in its approach to multi-unit waste services in North America. In the majority of Canadian municipalities, multi-unit residential waste is treated as Industrial, Commercial and Institutional (ICI) Waste and collection services are provided by the private sector. The City of Edmonton includes multi-unit waste residences in its residential collection program and administers the distribution of containers to collect waste from various streams (namely garbage and recycling) for all multi-unit residential building sites. The collection work is split between the City forces and contracted forces under the Waste Services' administration.

City Council approved a demonstration Cart rollout project in late 2018 and approved Waste Services' 25-year strategy in October 2019. Changes to the waste container profile to support these decisions are listed below:

- In 2019, Waste Services provided 16,000 garbage and food scraps carts to 8,000 homes for demonstration of the new curbside collection program, which separated food scraps and yard waste from garbage at the curb for increased diversion from landfills. In 2021, this new curbside collection program was expanded to all curbside collection units. As of August 2022, over 250,000 single-unit and multi-unit residents are receiving the program with 530,000 City owned curbside carts. The 16,000 carts purchased in the demonstration phase in 2019 were funded from the Waste Container profile. The 500,000+ carts purchased in 2021 and 2022 were funded in the standalone Cart Rollout profile 20-81-2041. The Cart Rollout project will be completed in 2022, and from 2023, additional carts required for new homes (growth) will be included in the Waste Container profile.
- Waste Services has started winding down the commercial collection from late 2019. Waste containers will no longer be purchased for this discontinued program.

In April 2022, City Council approved a business case for Residential Communal Collection to implement three stream mandatory source separation for all multi-unit properties receiving communal collection. All additional waste containers required for implementing this project will be included in a standalone profile for this project, which is expected to be completed in 2028.

Waste Services currently operates a container maintenance program where slightly damaged containers are repaired to working condition. Under this program, residents or Waste Services collection crews report the presence of damaged waste containers. The reported damage is inspected by Waste Services or a contractor and container repairs are carried out by a container maintenance crew. If the container maintenance crew can not repair the container on-site, it is

⁶ Waste Services Utility Fiscal Policy C558B

replaced and brought back to the yard for further assessment. If the damage is too extensive and deemed not economically feasible to repair, the container is salvaged for any usable items and scrapped or recycled. Container accessories are serviced on an as-needed basis.

6. Organizational Change Impact

6.1. Stakeholder Impact

Stakeholder Impact
Stakeholder 1: City of Edmonton Waste Services Branch (primary internal)
Maintain adequate container inventory to enable growth and replacement of containers at or near the end of service life or beyond economically feasible repair.
Stakeholder 2: Single-unit and multi-unit residents (primary external)
Maintain service levels for residential waste collection.
Stakeholder 3: Waste Containers Contractors (external)
Maintain service levels and decrease service disruption.

6.2. Business and Operational Impact

Business & Operational Impact & Description
Human Resources: Waste Services (Internal)
Resources and organizational structure will be reviewed to ensure effective delivery of program
Procurement: Corporate Procurement and Supply Services (internal)
Increase in resource demand to provide procurement support
Legal Support: Law Branch (internal)
May require additional resources for legal support, review of contract for non-standard contract terms and conditions as well as review of documents to support procurement

The 25-year Waste Strategy recognizes the importance of customer service and support being integral to the Strategy's success. The learnings from adoption of the Edmonton Cart Rollout will continue to ensure that Waste Services programs are responsive and adjusted as required. More work is being done to understand how customers interact with the various services and

ensure support and education programs, including new digital programs, are responsive to customer needs.

Moving forward, the City of Edmonton is committed to the use of Gender-Based Analysis Plus (GBA+). Waste Services will identify root causes on any issues that may arise, use an evaluation approach, consider the inputs from affected stakeholders (e.g. people with disabilities, indigenous people, seniors, etc.), and develop and implement an action plan for safety, diversity and inclusivity issues using GBA+. Waste Services acknowledges that GBA+ is an equity assessment tool that allows for holistic consideration of the need for use, and impact of, this capital funding request and that staff are trained in the GBA+ process.

7. Benefits / Costs

7.1. Tangible Benefits

The following tangible benefits are anticipated to be realized:

- Adequate waste container stock to meet service demands of growth
- Adequate waste container stock to replace containers at or near end of service life
- Predictable purchase pattern

7.2. Intangible Benefits

The following intangible benefits are anticipated to be realized:

- Mitigated purchase risks through ability to plan for purchases of waste containers and a predictable purchase pattern
- Better inventory management practices in place to enhance business area's accountability

7.3. Costs

The financial costs for the 2023-2026 budget cycle are based on forecasted demand for steel and plastic bins, litter baskets, curbside carts and accessories.

Year	2023 (\$)	2024 (\$)	2025 (\$)	2026 (\$)	2023-2026 Total (\$)
Capital Funding Requested	\$3,382,704	\$4,015,709	\$4,232,036	\$4,500,760	\$16,131,209
Operating Cost	\$285,850	\$331,993	\$365,142	\$396,142	\$1,379,128

For further details of the capital required in this request, please refer to Appendix B for a breakdown of container type and budget.

7.4. Assumptions

- Costs are based on market available prices.
- Pricing may be impacted by market and commodity prices, like steel and plastics. Based on the latest contractor quotes, this has influenced the rate of escalation incorporated into the estimates above, ranging from 2.35% for plastic bins to an initial hike of 32% for steel bins.
- All containers have a 15-year useful life.
- Forecasted annual demands of the containers during the 2023-26 budget cycle have been estimated by needs assessment performed by Waste Services. The primary factors considered for the needs assessment are - lifecycle replacement, growth, operational needs, and program changes.

8. Resourcing

Corporate procurement methods will be used to purchase required waste containers and associated accessories.

9. Key Risk(s) and Mitigation Strategy

RISK	IMPACT	MITIGATION STRATEGY
Escalation in container pricing	Medium	<ul style="list-style-type: none"> • Open and transparent competitive tendering process to attain lowest feasible cost for replacement
Limited numbers of manufacturing companies to provide containers	Medium	<ul style="list-style-type: none"> • Work with Corporate Procurement and Supply Services to optimize tendering strategies to ensure specifications and timelines are managed
Delay in issuing tender and getting contract signed	Medium	<ul style="list-style-type: none"> • Work with Corporate Procurement and Supply Services to optimize tendering strategies to ensure specifications and timelines are managed

10. Conclusion and Recommendations

10.1. Conclusion

This profile will provide capital funding for the purchase of new and replacement waste containers and associated accessories to ensure Waste Service has an adequate supply through 2023-2026. This funding will ensure waste containers are available to enable and

support growth as well as the replacement of waste containers that have reached the end of their service life.

10.2. Recommendations

It is recommended that this profile with funding of \$16.1 million be approved to assist Waste Services to meet its commitment of delivering integrated and sustainable waste management services.

10.3. Project Responsibility and Accountability

The Project Sponsor is the Branch Manager of Waste Services. The overall capital program is managed by the Director of Technical Services, in collaboration with Sustainable Waste Processing Services, Collection Services, Business Integration and Waste Strategy, and Financial Services.

11. Implementation Approach

When containers are required and funding is secured, purchases of new containers are made through existing contracts. Containers will be purchased on time to maintain the inventory needed to provide current and future demands.

The General Supervisor of Collection Services, reporting to the Director of Collection Services, is responsible for inspection, maintenance and procurement of containers. Waste Services is currently working on improving its inventory management system to incorporate best industry practices for tracking, managing and reporting on waste containers in the future. This will enable the branch to purchase containers on time and maintain an appropriate level of inventory. This will also help Waste Services to measure the performance of the container program by measuring if adequate inventory is in place and the timeliness of container inspection and the procurement process.

12. Review and Approval Process

The following review and approval process was followed for this capital funding request:

Review Step	Reviewer
Review 1	Team Lead of Technical Services, General Supervisor of Business Integration, General Supervisor of Collection Services, General Supervisors of Sustainable Waste Processing, General Supervisors of Technical Services, and Senior Accountant of Financial Services.
Review 2	Director of Finance, Director of Business Integration, Director of Collection Services, Director of Sustainable Waste Processing, Director of Technical Services (Final Approver) and Senior Communications Advisor.

Review 3	Branch Manager Waste Services (Final Approver)
Review 4	Utility Advisor
Review 5	Utility Committee report presented

13. Appendices

Appendix A: Financial Analysis Summary

Appendix B: Waste Container Type and Budget

Appendix A: Financial Analysis Summary

Project Title: Waste Services Containers	Procure Containers, Status Quo
Total Capital Cost	(\$16,131,209)
Total Revenues	\$0
Total Operating and Maintenance Costs	(\$3,557,910)
Total Lease Costs	\$0
Project Net Inflows (Outflows)	(\$19,689,118)
WACC Discount Rate	6.28%
Project Cost (Present Value)	(15,221,104)

The following table and graph demonstrate the cumulative present value of the revenues that must be realized through annual rate collection to support the project costs. This includes operating and maintenance costs, interest and amortization expenses over the project lifecycle.

**Project Title: Waste Services Containers
Cumulative Present Value of Revenue Requirement**

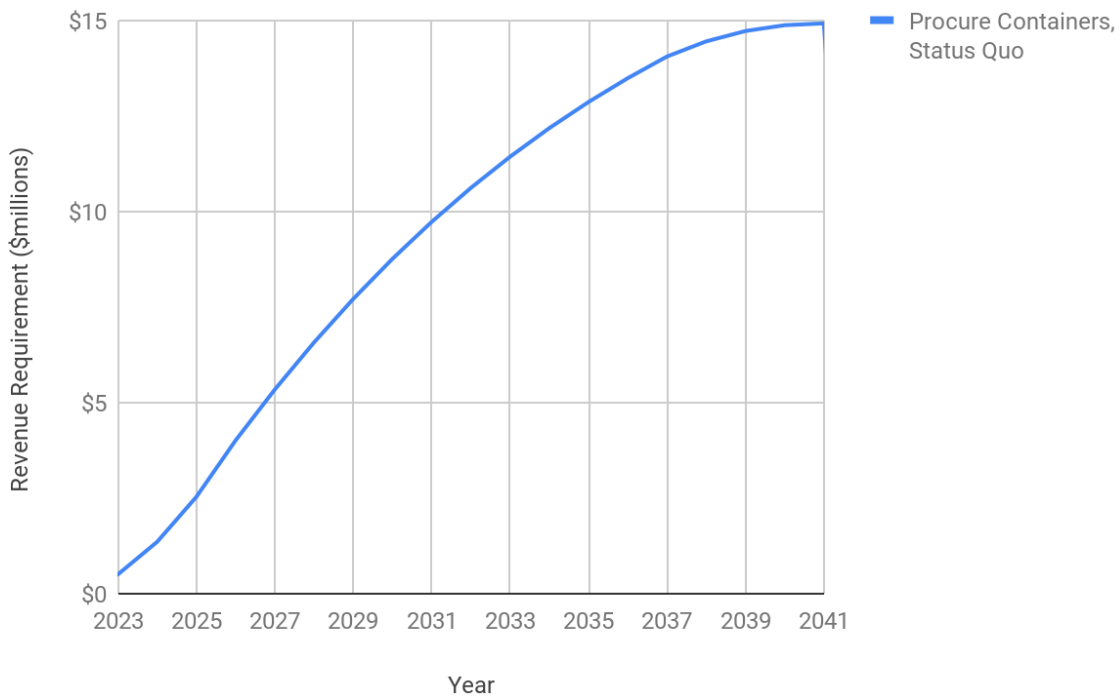

Year	Calendar Year	Procure Containers, Status Quo
0	2022	\$0
1	2023	\$493,705
2	2024	\$1,344,918
3	2025	\$2,523,269
4	2026	\$3,999,859
5	2027	\$5,332,205
6	2028	\$6,564,458
7	2029	\$7,702,723
8	2030	\$8,752,740
9	2031	\$9,719,910
10	2032	\$10,609,314
11	2033	\$11,425,730
12	2034	\$12,173,653
13	2035	\$12,857,310
14	2036	\$13,480,676
15	2037	\$14,047,492
16	2038	\$14,443,932
17	2039	\$14,714,385
18	2040	\$14,867,066
19	2041	\$14,914,248

***Note:** calculation up to 2041 as last year of budget cycle is 2026 + 15 years useful life

Appendix B: Waste Container Type and Budget

Waste Container Type	Justification & Basis for Budget Estimates	2023 Estimate	2024 Estimate	2025 Estimate	2026 Estimate	Total
Steel Bins (Includes front load bins, side load bins, roll off containers)	Life cycle replacement and Growth	\$2,354,504	\$2,529,193	\$2,655,653	\$2,788,436	\$10,327,786
Litter Baskets	Life cycle replacement and Growth	\$36,715	\$40,387	\$41,336	\$42,308	\$160,746
Plastic Front Load Bins	Life cycle replacement and Growth	\$35,260	\$300,735	\$246,242	\$252,028	\$834,265
Curbside Carts	Primarily growth	\$937,330	\$1,079,983	\$1,221,857	\$1,349,467	\$4,588,637
Accessories (casters, lids, liners etc)	As required	\$18,895	\$65,411	\$66,948	\$68,521	\$219,775
TOTAL		\$3,382,704	\$4,015,709	\$4,232,036	\$4,500,760	\$16,131,209

CAPITAL PROFILE REPORT

PROFILE NAME: **WASTE CONTAINERS**
PROFILE NUMBER: **CM-81-2005**
DEPARTMENT: **Utilities**
LEAD BRANCH: **Waste Services**
PARTNER:
BUDGET CYCLE: **2023-2026**

RECOMMENDED FUNDED

PROFILE STAGE:	Approved
PROFILE TYPE:	Composite
LEAD MANAGER:	Denis Jubinville
PARTNER MANAGER:	
ESTIMATED START:	January, 2023
ESTIMATED COMPLETION:	December, 2026

Service Category:	Utilities	Major Initiative:	
GROWTH	RENEWAL	PREVIOUSLY APPROVED:	-
40	60	BUDGET REQUEST:	16,131
		TOTAL PROFILE BUDGET:	16,131

PROFILE DESCRIPTION

The Waste Services Waste Container Capital Profile CM-81-2005 recommends funding for the purchase of steel bins (front load, side load, and roll-off waste containers), litter baskets, plastic bins, curbside carts, and associated accessories used in Waste Services' waste collection and drop-off programs. The purchase of waste containers supports Edmonton's urban growth as well as the replacement of waste containers that have reached the end of their service life or are beyond economically feasible repair. This profile will also support the growth of the curbside Source Separated Organics (SSO) program (i.e. curbside carts).

The four-year total capital projection is approximately \$16.1 million.

Containers are purchased each year to ensure an even expenditure pattern and maintain the desired service level of containers. The expected outcome is to continue to provide efficient collection service to Edmontonians in a safe, environmentally and economically sustainable manner.

The \$16.1 million requested in this profile considers forecasted demand for replacement and planned urban growth, including impacts related to global supply chain issues and resulting increases in commodity pricing. It also includes approximately \$4.6 million of curbside containers that were previously included under the Source Separated Organics standalone profile in 2019-2022.

PROFILE BACKGROUND

Waste Services has an inventory of over 500,000 waste containers each with an average service life of fifteen years, that require replacement at the end of their service life. New containers are required to meet growth demands for various waste collection and drop-off programs across the City. Waste containers for both replacement and growth need to be purchased on a regular basis to maintain an adequate inventory and availability of stock to meet demand. As Waste Services plans for future growth and replacement of older or damaged waste containers, there is an opportunity to adopt a proactive, long-term purchase planning approach to mitigate external risk factors, including global supply chain risks, uncertainty in the price of raw materials (steel, plastics, etc.) to build containers, and potential for changes to existing international trade agreements. Access to the required capital through the capital planning horizon enables mitigation of these risks and a level of certainty in the planning and purchase of waste containers.

PROFILE JUSTIFICATION

Waste Services retains a limited quantity of new containers in stock to meet urgent demands and ensure uninterrupted operation, however, this capital funding profile is used to purchase the required inventory to account for forecasted growth and lifecycle replacement of container assets.

Without support for this composite profile, container availability would be severely undersupplied leading to negative impacts on the environment and Waste Services programs and targets. The Utility would also experience higher risk of failure and maintenance costs of existing containers beyond their useful lives, leading to inefficiencies in waste collection services and potential safety issues. It is critical that this profile is approved to ensure continuity of container and accessory replacement and availability of stock.

The anticipated outcomes of the purchase of new waste containers include asset integrity, system reliability, efficiency, and enhanced safety; maintain high levels of customer service and realize process efficiencies through the use of sector-appropriate waste containers; maintain an adequate inventory of waste containers to meet the service demands for growth and replacement of containers at or near the end of their life cycle; and capitalize on opportunities to reduce operational costs.

STRATEGIC ALIGNMENT

Waste Services is committed to advancing Council's vision and goals. This capital funding request contributes to the overall strategic direction of City council and the goals and policies of the corporate strategic documents listed below. This contribution is made by demonstrating leadership in waste management and waste collection standards, and by increasing the diversion of residential and non-residential waste from landfill.

City of Edmonton Environmental Policy C512, Connect Edmonton: Vision 2050, Waste Services Business Plan 2022-2025, 25 Year Waste Strategy

ALTERNATIVES CONSIDERED

This is a capital funding request and does not present any alternatives for consideration. This profile is taking a status quo approach (purchasing new containers as required) as this was already determined to be the best alternative in the 2019-2022 budget cycle business case.

COST BENEFITS

The following tangible benefits are anticipated:

Adequate waste container stock to meet service demands of growth
Adequate waste container stock to replace containers at or near end of service life
Predictable purchase pattern

The following intangible benefits are anticipated:

Mitigated purchase risks through ability to plan for purchases of waste containers and a predictable purchase pattern
Better inventory management practices in place to enhance business area's accountability

KEY RISKS & MITIGATING STRATEGY

RISK: Escalation in container pricing MITIGATION: Open and transparent competitive tendering process to attain lowest feasible cost for replacement

RISK: Limited numbers of manufacturing companies to provide containers MITIGATION: Work with Corporate Procurement and Supply Services to optimize tendering strategies to ensure specifications and timelines are managed

RISK: Delay in issuing tender and getting contract signed MITIGATION: Work with Corporate Procurement and Supply Services to optimize tendering strategies to ensure specifications and timelines are managed

RESOURCES

Corporate procurement methods will be used to purchase required waste containers and associated accessories.

CONCLUSIONS AND RECOMMENDATIONS

This profile will provide capital funding to purchase new and replacement waste containers and associated accessories to ensure Waste Services has an adequate supply through 2023-2026. This funding will ensure waste containers are available to support growth and replace waste containers that have reached the end of their service life.

It is recommended that this profile with funding of \$16.1 million be approved to assist Waste Services in delivering integrated and sustainable waste management services.

Project Sponsor is the Branch Manager of Waste Services. The overall capital program is managed by the Director of Technical Services, in collaboration with Sustainable Waste Processing Services, Collection Services, Business Integration and Waste Strategy, and Financial Services.

CAPITAL PROFILE REPORT

PROFILE NAME: **Waste Containers**
 PROFILE NUMBER: **CM-81-2005**
 BRANCH: **Waste Services**

RECOMMENDED FUNDED
 PROFILE TYPE: **Composite**

CAPITAL BUDGET AND FUNDING SOURCES (000's)

APPROVED BUDGET		Prior Years	2022	2023	2024	2025	2026	2027	2028	2029	2030	Beyond 2030	Total
	Approved Budget												
	Original Budget Approved	-	-	-	-	-	-	-	-	-	-	-	-
	Current Approved Budget	-	-	-	-	-	-	-	-	-	-	-	-

BUDGET REQUEST	Budget Request	-	-	3,383	4,016	4,232	4,501	-	-	-	-	-	16,131
	Revised Funding Sources (if approved)												
	Self-Liquidating Debentures	-	-	3,383	4,016	4,232	4,501	-	-	-	-	-	16,131
	Requested Funding Source	-	-	3,383	4,016	4,232	4,501	-	-	-	-	-	16,131

REVISED BUDGET (IF APPROVED)	Revised Budget (if Approved)	-	-	3,383	4,016	4,232	4,501	-	-	-	-	-	16,131
	Requested Funding Source												
	Self-Liquidating Debentures	-	-	3,383	4,016	4,232	4,501	-	-	-	-	-	16,131
	Requested Funding Source	-	-	3,383	4,016	4,232	4,501	-	-	-	-	-	16,131

CAPITAL BUDGET BY ACTIVITY TYPE (000's)

REVISED BUDGET (IF APPROVED)	Activity Type	Prior Years	2022	2023	2024	2025	2026	2027	2028	2029	2030	Beyond 2030	Total
		Equip FurnFixt	-	-	3,383	4,016	4,232	4,501	-	-	-	-	-
	Total	-	-	3,383	4,016	4,232	4,501	-	-	-	-	-	16,131

OPERATING IMPACT OF CAPITAL

Type of Impact:

Branch:																
	Rev	Exp	Net	FTE	Rev	Exp	Net	FTE	Rev	Exp	Net	FTE	Rev	Exp	Net	FTE
Total Operating Impact	-	-	-	-	-	-	-	-	-	-	-	-	-	-	-	-

CAPITAL PROFILE REPORT

PROFILE NAME: Waste Containers			
PROFILE NUMBER: CM-81-2005			
BUDGET CYCLE: 2023-2026			
Project Number	Project Name	Description	Percentage Funded
230001	Waste Containers	Waste Containers	100



Waste Services Fleet Assets - Composite

Capital Funding Request

City Operations | Waste Services

City of Edmonton

Capital Profile: CM-81-2048 Composite

Project Number: CP# / Various

Profile Owner: Krista Berezowski

Profile Sponsor: Denis Jubinville

Version #: 2.0

Date published: August 05 2022

TABLE OF CONTENTS

Change History	4
Document Approval	4
Indigenous Acknowledgement	5
Executive Summary	6
Fleet Assets Composite Renewal	6
Background	6
Problem / Opportunity	6
Current Situation	7
Initiative Description	8
Initiative Description	8
Urgency of Need	8
Anticipated Outcomes	9
Scope	10
Out of Scope	10
Critical Success Factors	10
Strategic Alignment	10
Context Analysis	12
Organizational Change Impact	13
Stakeholder Impact	13
Business and Operational Impact	14
Cost Benefits	15
Tangible Benefits	15
Intangible Benefits	15
Costs	16
Assumptions	16
Resourcing	16
Key Risk(s) and Mitigation Strategy	17
Conclusion and Recommendations	17
Conclusion	17
Recommendations	17
Project Responsibility and Accountability	17
Implementation Approach	18

Review and Approval Process	18
Appendices	20
Appendix A: Deteriorated Fleet Assets	20
Appendix B: Replacement Schedule	21
Appendix C: Availability Trends 2020 - 2022	25
Appendix D: Advanced Commitments	26
Appendix E: Financial Analysis Summary	27

Change History

Version #	Date	Author	Description
1.0	08/05/22	Spencer de Klerk	First draft of Capital Funding Request
2.0	08/16/22	Spencer de Klerk	Second draft of Capital Funding Request

Document Approval



SUBMITTED BY:

Version #	Submitter Name	Signature	Submission Date
2.0	Spencer de Klerk Manager, Process Maintenance Operations & Fleet	Spencer de Klerk	August 16, 2022

REVIEWED BY:

Version #	Reviewer Name and Title	Signature	Signing Date
2.0	Keith Knoblauch Operational Controller, Business Financial Analytics		Aug 24, 2022
2.0	Jodi Goebel Director, Business Integration	Jodi Goebel	August 30, 2022
2.0	Neil Kjelland Director, Sustainable Waste Processing	Neil Kjelland	Aug 22, 2022
2.0	Chris Fowler Director, Collections Services	Chris Fowler	Aug 17, 2022

APPROVED BY:

Version #	Approver Name and Title	Signature	Signing Date
2.0	Krista Berezowski Director, Technical Services		September 9, 2022
2.0	Denis Jubinville Branch Manager, Waste Services		September 12, 2022

Indigenous Acknowledgement

Edmonton is located within Treaty 6 Territory and within the Métis homelands and Métis Nation of Alberta Region 4. We acknowledge this land as the traditional territories of many First Nations such as the Nehiyaw (Cree), Denesuliné (Dene), Nakota Sioux (Stoney), Anishinaabe (Saulteaux) and Niitsitapi (Blackfoot).

The City of Edmonton owes its strength and vibrancy to these lands and the diverse Indigenous peoples whose ancestors' footsteps have marked this territory as well as settlers from around the world who continue to be welcomed here and call Edmonton home.

Together we call upon all our collective honoured traditions and spirits to work in building a great city for today and future generations.



1. Executive Summary

1.1. Waste Services Fleet Assets Composite Renewal

Composite profile CM-81-2048 supports the replacement of Fleet Assets (Waste Services Vehicles & Equipment). The approach followed by this profile closely aligns with Edmonton's 25-year Waste Strategy that outlines how the City demonstrates leadership and encourages residents, businesses and institutions to actively participate in better managing their waste and ultimately reducing the amount of waste generated in Edmonton.

With a net replacement value of approximately \$95.1 million, the Waste Services fleet consists of self-propelled equipment, heavy-duty trucks, trailers, light trucks and vehicles. Fleet assets are used to collect, process, recycle and dispose of waste for over 400,000 residential households. Fleet assets physically deteriorate with use and age; timely asset replacement improves the fleet's availability and results in a lower average operating cost per kilometer/hour. Replacement is done by purchasing new units once they reach the end of their useful operating life.

Waste Services requires approximately \$45.1M for the next four-year capital budget cycle to replace fleet assets at the end of their useful lives, of which \$34.3M is requested in this Funding Request and \$10.8M was pre-approved in September 2022 to ensure orders will arrive in 2023-2024 when required. The level of funding requested will enable Waste Services to continue to meet its commitment to provide sustainable waste management services and align with Edmonton's 25-year Waste Strategy¹.

2. Background

2.1. Problem / Opportunity

As fleet assets near or reach end of life, they deteriorate (Appendix A) and need to be replaced to meet Waste Services' commitment to providing sustainable waste management services to residents. In this capital funding request, customers' additional needs for the next four years can be met with the replacement of fleet assets as scheduled (Appendix B).

The four-year capital plan for the Waste Services fleet, funded through utility rates, identifies 152 assets required for replacement. The level of funding requested will enable Waste Services to continue to meet its commitment to provide sustainable waste management services aligned with Edmonton's 25-year Waste Strategy.

2.2. Current Situation

Waste Services use fleet assets to collect and process waste (garbage, organics and recyclables); these assets have an operating life of five to ten years. Replacing fleet assets

¹ Waste Services 25-year Waste Strategy

ensures higher availability, lower maintenance cost and newer technology that meets the latest emission and fuel efficiency standards. Fleet assets are maintained by in-scope City of Edmonton employees at the Edmonton Waste Management Centre (EWMC) and Kennedale Garage. Fleet assets may require unplanned capital refurbishment based on use and condition; this is done to extend the asset's operating life when deemed economically viable.

Waste Services tracks the performance of fleet assets continuously; one key metric is fleet availability, which generally quantifies the probability that fleet assets are in operational condition. Availability targets for the Waste Fleet are based on equipment class; as of July 2022, overall availability was 84% (Appendix C).

Current inventory of Waste Fleet Assets

Vehicle Type	Count	Operating Life	Criticality	Availability	WS Target
Tandem Collection Trucks	79	10	High	78.5%	75%
Midsized Collection Trucks	22	10	High	86.4%	75%
Rear Load Collection Trucks	11	9	High	75.6%	75%
Front Load Collection Trucks	18	9	High	80.6%	75%
Truck - Recycling (Pendpac)	4	8	High	63%	75%
Roll-off Trucks	6	9	Medium	85.9%	75%
Telescoping Loader	1	10	Medium	93.2%	80%
Long Haul Tractors	23	6	High	77.1%	80%
Long Haul Trailers	54	8	High	85.6%	85%
Wheel Loaders	14	5	High	85.1%	85%
Excavators	3	6	High	92.5%	80%
Forklifts	5	10	Medium	94.8%	80%
Skid steer	7	10	Medium	88.9%	80%
Light Vehicles	60	10	Medium	94.9%	80%
Other (screeners, turners)	92	Varies	Varies	89.9%	80%

3. Initiative Description

3.1. Initiative Description

This capital funding request will ensure adequate funding is available to replace Waste Services Fleet Assets as prescribed by Fleet and Facility Services; funding is outlined in the Fleet Assets (Waste Services Vehicles and Equipment) capital profile CM-81-2048.

3.2. Urgency of Need

73.9% of Waste Services fleet assets are within their useful operating life. If capital funding is not approved and fleet assets are not replaced, only 44.1% of the fleet will remain within its useful operating life by year-end 2026.

Replacement Status of Waste Fleet (July 2022)

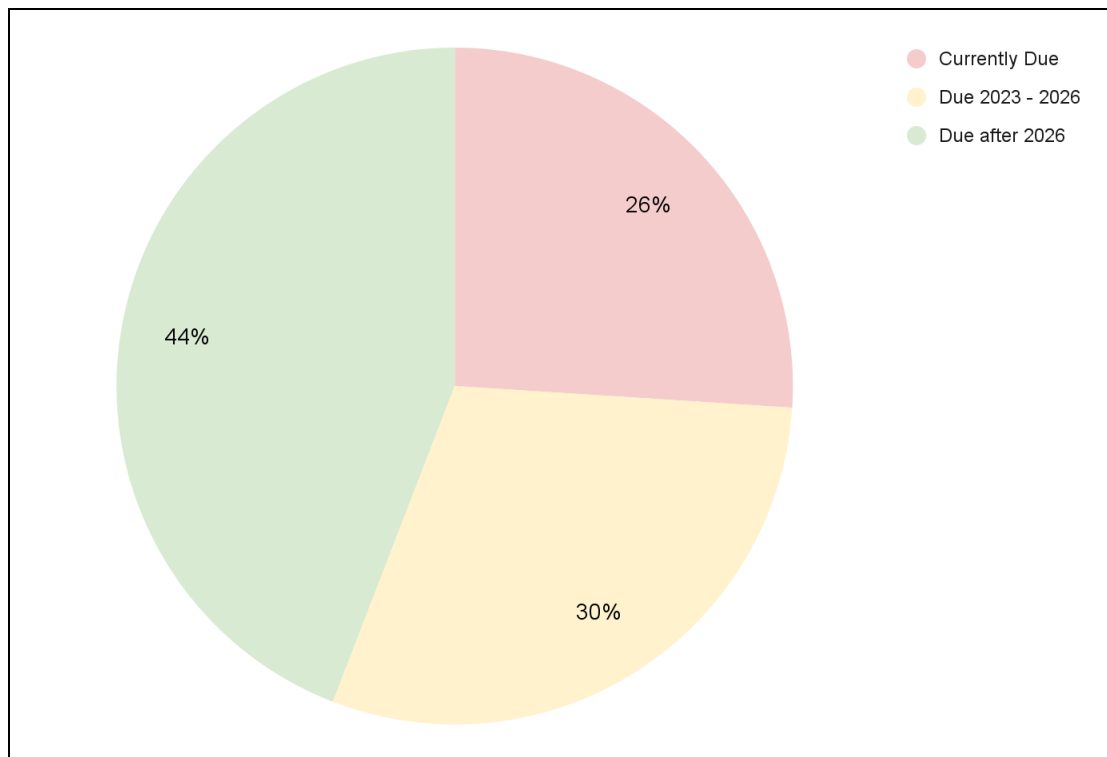

Historical data indicates if fleet assets are not replaced within or at the end of their useful operating life, maintenance and fuel costs increase while levels of service decline. For example, in the chart below for the curbside tandem fleet, the trucks past the 10-year life cycle cost an average of \$59,022 per year. The first three years of operation cost an average of \$22,387 per year. For 10 trucks operating past their 10-year lifecycle, it would cost the City an additional \$366k annually to operate.

Average Annual Kilometers per Truck and Job Cost/Kilometer - Capital Work Excluded

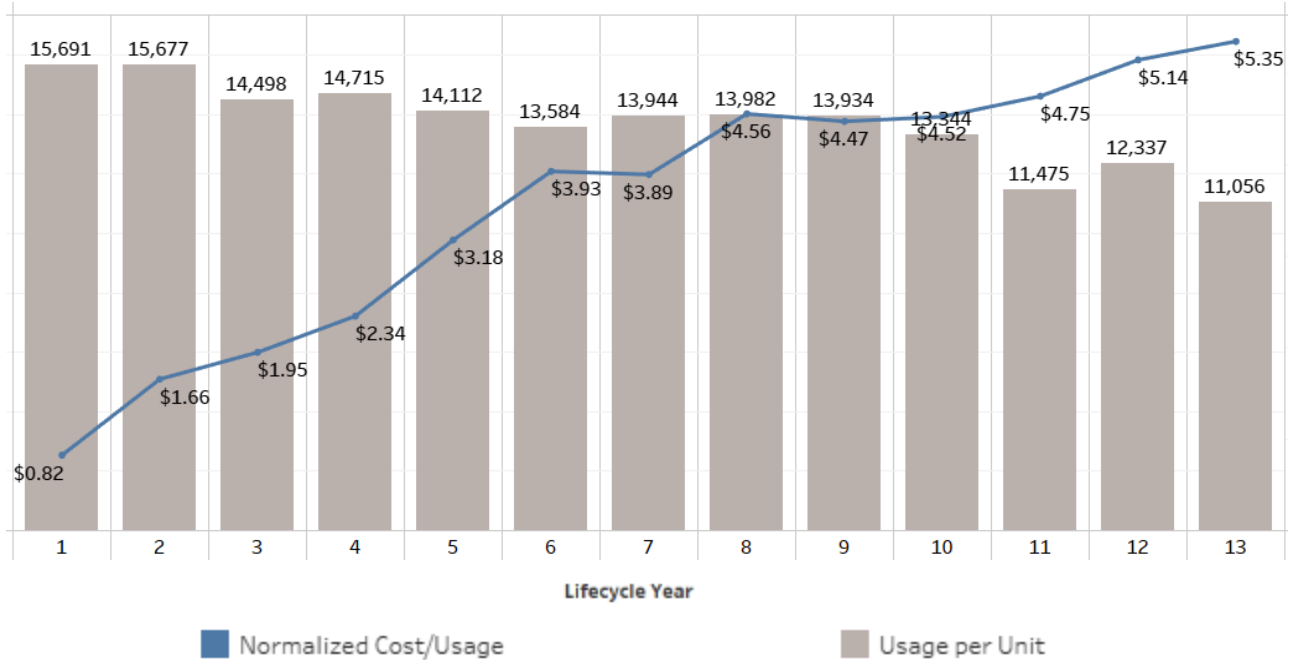

3.3. Anticipated Outcomes

Effective asset management will ensure Waste Services have the resources to achieve objectives by aligning vision, mission and strategy with daily activities to achieve goals. Waste Services envisions the following outcomes:

Outcome/Deliverables
Better information to make capital investment decisions: Through a structured and integrated process, administration will ensure that fleet acquisitions identified as a high priority to Waste Services receive a robust evaluation of alternatives and scope identification.
Improved replacement schedules and budget estimates: Fleet and Facility Services owns a variety of competitive long-term service agreements; this enables acquisitions to be done efficiently with prices that are locked in.
High levels of customer service are delivered in efficient and effective ways through leading-edge waste self-propelled equipment that uses current and emergent technology to enable high rates of diversion of waste from landfill.
Reliable fleet assets that will deliver cost-effective, sustainable waste management.

3.4. Scope

This profile is required to provide the funding for the replacement of fleet assets required for the daily operations of the Waste Collections and Sustainable Waste Processing Services; assets include but are not limited to;

- Equipment Self Propelled (loaders, compost turners, skid-steers, screeners)
- Heavy Trucks/Vans (refuse trucks, long haul tractors)
- Light Trucks/Vans (pickup trucks, sanding trucks, crane trucks)
- Trailers (walking floor trailers, end-dump trailers, utility trailers)
- Attachments (forks, buckets, sweeper, arms)

3.5. Out of Scope

- Fleet assets previously approved by Council (SCBA & Communal Collections Project)
- Fixed assets (Processing & Infrastructure)
- Waste bins and containers
- Light duty vehicles leased by Corporate Procurement and Supply Services
- New initiatives to increase diversion rates (e.g., Waste to Energy)
- Climate change initiatives (e.g., pilot projects)
- Operational maintenance activities

3.6. Critical Success Factors

- Adherence to the asset management framework and fleet asset replacement program
- Proper design and maintenance programming for fleet assets
- Availability of resources to support the replacement program
- Accurate and sufficient data to make informed decisions

4. Strategic Alignment

Waste Services is committed to advancing Council's vision and goals. This capital funding request contributes to the overall strategic direction of City Council and goals of the policies and corporate strategic documents listed in the table below. This contribution is made by demonstrating leadership in waste management and processing standards and increasing the diversion of residential and non-residential waste from landfill.

<p>City of Edmonton Environmental Policy C512²</p>	<p>The policy states, “The City of Edmonton, through its planning, decision-making processes, and leadership, will promote the development of an environmentally sustainable community that functions in harmony with the natural environment.</p> <p>The City of Edmonton will exercise environmental stewardship of its operations, products and services based on its commitment to</p> <ul style="list-style-type: none"> a) prevent pollution; b) continually improve its environmental performance by setting and reviewing environmental objectives and targets, and c) meet or exceed applicable environmental legal requirements and other requirements to which it subscribes.”
<p>ConnectEdmonton: Vision 2050³</p>	<p>This profile supports the City’s Vision 2050 strategic plan goal that waste is collected efficiently, processed responsibly, and the amount landfilled is minimized. Edmonton will be a healthy city, urban places will be clean, regional prosperity is increased by building a circular economy, and a low-carbon future is assured.</p>
<p>Waste Services Business Plan 2022-2025⁴</p>	<p>The Business Plan outlines how Waste Services will continue to make transformational impacts through the 25-Year Waste Strategy, provide essential services to Edmontonians while maintaining full cost recovery, and improve the employee and resident experience to support the adaptation of new systems.</p>
<p>25-Year Waste Strategy⁵</p>	<p>Using a Zero Waste Framework, the strategy affirms Waste Services’ commitment to a 90 per cent diversion of single-unit residential waste from landfill. It also aligns Edmonton with internationally-recognized best practices, putting more emphasis on waste prevention and waste reduction while redesigning services to help all Edmontonians more easily take part in Edmonton’s zero-waste future.</p>

² COE Environmental Policy C512

³ ConnectEdmonton

⁴ WS Business Plan 2022-2025

⁵ 25 Year Waste Strategy

Waste Services Utility Fiscal Policy C558B ⁶	The purpose of this policy is to: <ul style="list-style-type: none"> • Ensure that the Waste Services Utility is operated in a manner that reflects City Council’s overall vision and philosophical objectives for the Utility. • Ensure a consistent approach year-over-year for the financial planning, budgeting, and rate setting for the City managed Utility. • Ensure that the Utility is financially sustainable over the long term.
Capital Project Governance Policy C591 ⁷	Policy C591 states that the City of Edmonton is committed to achieving effective and efficient use of public funds for capital projects.

5. Context Analysis

The current model for fleet asset replacement (Appendix B) is based on life-cycle analysis completed by Fleet and Facility Services and Waste Services Asset Management. Fleet and Facility Services currently maintains 392 fleet assets for Waste Services (out of roughly 3,600 across the corporation) and advises on unit condition towards the end of its prescribed life cycle and potential options for replacement. Fleet and Facility Services acquire and dispose of assets scheduled for replacement.

Owning and replacing mobile assets at the end of their useful life is standard practice in most large municipalities. An alternative to this approach, leasing fleet assets, was explored in 2018 by Fleet Services; the findings concluded that it would cost rate-payers approximately 35% more and take work away from in-scope City of Edmonton employees. This alternative has not been further explored due to the significant cost implications. Centralized management of the fleet is standard practice for large municipalities.

Edmonton’s 25-year Waste Strategy defines a path of ambitious, transformational change toward a zero-waste future. A critical element of that path is the target of 90 per cent waste diversion across all sectors in Edmonton; reaching that target requires the implementation of three-stream source separation in every sector. Alternatives for Communal collections were explored in a business case and submitted to the Utility Committee in April 2022; it was decided that the risks associated with privatizing the program outweighed the benefits. Collection Services will leverage existing contracts in a 50/50 split for Communal and Curbside collections to keep the market competitive and offer rate-payers the best value for their money.

Sustainable Waste Processing is similar to most bulk material handling operations, requiring a large contingent of self-propelled equipment like excavators, front-wheel loaders and skid-steers to transfer material into various processing streams. For waste that cannot be diverted and requires long-haul transfer to landfill, the City will continue to leverage existing contracts using

⁶ Waste Services Utility Fiscal Policy C558B

⁷ Capital Project Governance Policy C591

Contractor-owner long-haul tractors and City-owned walking floor trailers to deal with peak demand if in-house resources are not available.

Process Flow Diagram - RDF (showing dependency on mobile equipment)

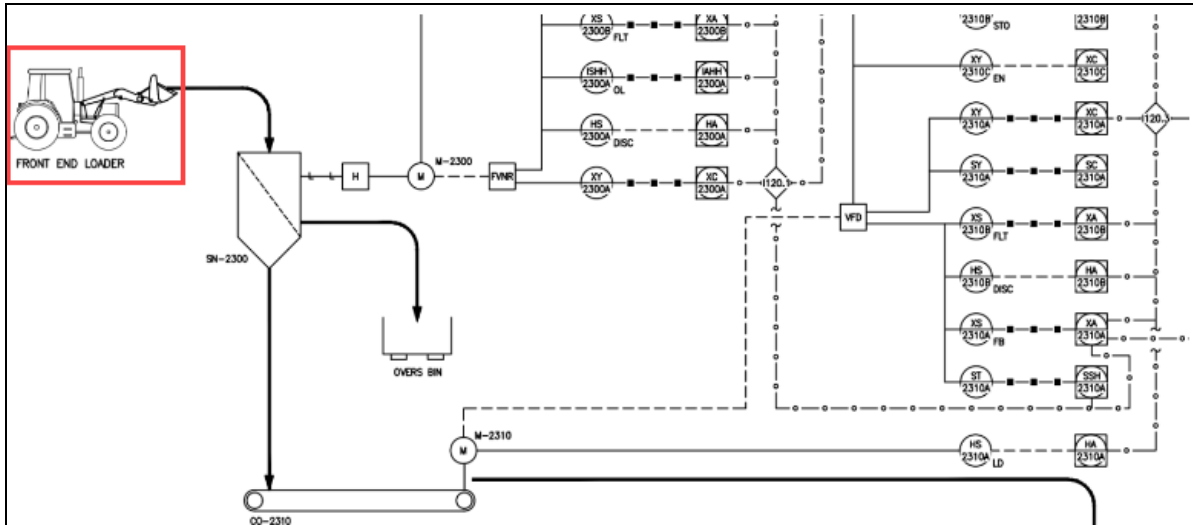

Functional Block Diagram - RDF (showing dependency on mobile equipment)

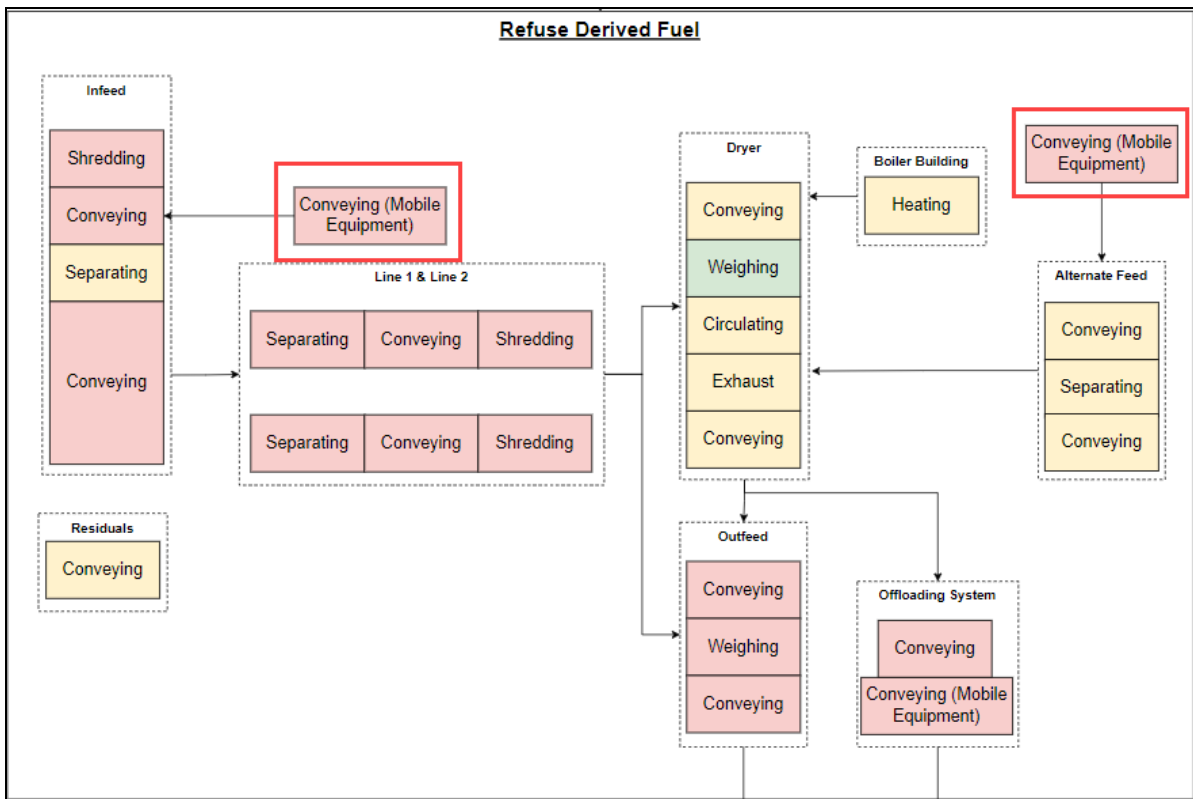

6. Organizational Change Impact

6.1. Stakeholder Impact

Stakeholder Impact
Stakeholder 1: City of Edmonton Waste Services Branch (<i>primary internal</i>)
Equipment downtime and maintenance fees will be reduced if assets are replaced on schedule. The branch will also realize enhanced levels of service.
Stakeholder 2: City of Edmonton Fleet and Facility Services (<i>primary internal</i>)
Unplanned maintenance will be reduced if fleet assets are replaced on schedule, leading to enhanced preventive maintenance practices.
Stakeholder 3: City Council & Utility Committee (<i>primary internal</i>)
Utility rates for Waste Services have a financial impact on citizens, which may result in citizen complaints to Council.
Stakeholder 4: Residents (<i>primary external</i>)
Utility rates for Waste Services have a financial impact on residents, which may result in citizen complaints to Council.
Stakeholder 5: Developers (<i>secondary external</i>)
Ensure that Waste Services can meet the demand for the collection and processing of waste and recyclables as the City grows.
Stakeholder 6: Commercial Customers (<i>secondary external</i>)
Limit commercial hauling waste rates/fees to increase the costs for waste services.

6.2. Business and Operational Impact

Business & Operational Impact
Human Resources: Waste Services (<i>internal</i>)
Existing resources are sufficient to deliver the program.

Human Resources: Fleet and Facility Services (internal)
Growth units will require additional maintenance resources; this is accounted for in the operational budget. Existing engineering resources within the department should be able to deliver the replacement schedule.
Procurement: Corporate Procurement and Supply Services (internal)
Procurement support will occasionally be required to create new service agreements.
Legal Support: Law Branch (internal)
Legal support will occasionally be required to review contract terms and conditions to support the procurement of numerous fleet acquisitions.

Moving forward, the City of Edmonton is committed to the use of Gender-Based Analysis Plus (GBA+). Waste Services will identify root causes of any issues that may arise, use an evaluation approach, consider the inputs from affected stakeholders (e.g. people with disabilities, indigenous people, seniors, etc.), and develop and implement an action plan for safety, diversity and inclusivity issues using GBA+. Waste Services acknowledges that GBA+ is an equity assessment tool that allows for a holistic consideration of the need for use and impact of this capital funding request and that staff are trained in the GBA+ process.

7. Cost Benefits

7.1. Tangible Benefits

The following tangible benefits are anticipated to be realized:

- Higher availability and service levels
- Significant savings in fuel and repair costs
- Reduced liability
- Higher resale values
- Improved safety due to less manual labour
- Reduction in greenhouse gas emissions

7.2. Intangible Benefits

The following intangible benefits are anticipated to be realized:

- Higher levels of employee satisfaction
- Higher levels of customer satisfaction
- Higher brand recognition

7.3. Costs⁸

Year	2023 (\$)	2024 (\$)	2025 (\$)	2026 (\$)	2023-2026 Total (\$)
Funding Requested	\$6,734,630	\$9,763,187	\$9,569,115	\$8,180,861	\$34,247,793
Pre-approved Funding *	\$5,100,000	\$5,730,000	-	-	\$10,830,000
Total Capital Profile	\$11,834,630	\$15,493,187	\$9,569,115	\$8,180,861	\$45,077,793
Incremental Operational Costs	\$276,026	-\$774,588	-\$369,312	-\$552,309	-\$1,420,183

*Funding of \$10,830,000 was pre-approved in September 2022 in CO01381 Waste Services Supplemental Capital Budget Adjustment Council Report. This allowed the Utility to commence procurement for vehicles in late 2022 to ensure delivery in 2023 and 2024 to meet capital and operating needs for this budget cycle. Please see Appendix D for listing of units included in the advanced approval.

7.4. Assumptions

- Inflation for the budget period is assumed at 2.35% as per the average Corporate assumption for 2023-2026.
- Fleet asset useful operating life is assumed to be five to ten years.
- Number of units to purchase was provided by Waste Services and reviewed by Fleet and Facility Services.
- Incremental operational costs are projected using an aging model, which translates into an expected cost for each life-cycle year. Only units listed within the overall plan were factored into the estimate. No inflationary assumptions were applied.
- Incremental operational costs are expected to translate into cost savings due to reduced maintenance costs on existing units and minimal operating costs for new units.

8. Resourcing

No additional resources are required for the implementation of this request. The Program Manager of Process Maintenance Operations and Fleet will act as the customer liaison for Fleet Asset acquisitions on behalf of Waste Services. A Fleet Project Engineer will develop equipment specifications and purchasing documents to work directly with suppliers.

⁸2023-26 WS Capital Planning Sheet

9. Key Risk(s) and Mitigation Strategy

Risks	Impact	Mitigation Strategy
Capital funding request is not approved	High	Retain existing assets and increase operating budget
Fleet assets are not replaced on schedule due to long delivery times	High	Long-term procurement plan focusing on ordering units with sufficient lead times
New fleet assets do not meet required service levels (design issues)	High	Fleet engineering resources will review the design and function of new acquisitions
Maintenance backlog (supply chain delays)	Medium	Stringent warranty clauses with a spare part strategy for critical assets will be implemented

10. Conclusion and Recommendations

10.1. Conclusion

Fleet asset replacement, as scheduled, will ensure vehicle availability, reliability, and safety. Approving this Capital Funding Request will authorize \$34.3M of fleet replacement for the 2023-2026 budget cycle.

10.2. Recommendations

Approve capital funding for this profile as it closely aligns with Edmonton's 25-year Waste Strategy that ensures Edmontonians receive maximum environmental benefits while minimizing the cost increases of managing solid waste. Approval of this Capital Funding Request will authorize \$34,247,793 retained earnings funding for vehicles and equipment (which does not include the \$10,830,000 already approved in September 2022).

10.3. Project Responsibility and Accountability

Procurement will be initiated internally by the Waste Services Asset Management team in Technical Services. Fleet and Facility Services are accountable for executing the replacement program identified within this composite profile. The Director of Technical Services manages the capital program, and the Branch Manager of Waste Services is the project sponsor.

11. Implementation Approach

Scheduled replacement of Fleet assets

Year	2023	2024	2025	2026	2023 - 2026 Total
Requested Replacements	28	32	32	37	129
Pre-Approved Replacements	12	11	-	-	23
Total Fleet Replacements	41	43	32	37	152

When funding is secured, vehicles will be purchased through Fleet and Facility Services. Acquisition plans and schedules are developed in collaboration with Waste Services, Fleet and Facility Services, and Corporate Procurement and Supply Services. Proposals from suppliers are evaluated by cross-functional teams consisting of engineers, buyers, operators, and maintainers, considering pricing, specifications, reliability, customer references and warranty. Corporate Delegation of Authority/Expenditure Authority Limits are followed in the procurement approval, contract management and payment lifecycle.

After fleet assets are acquired, they are catalogued into corporate Fleet Asset Information systems, Asset Works (M5) and Fleet Analytics & Strategic Technology (FAST). Maintenance programming and execution is governed by Fleet and Facility Services. Performance measures are tracked in M5 and FAST to substantiate decisions on equipment inventory and projected maintenance ratios to ensure service delivery standards are maintained. Fleet and Facility Services dispose of assets that are past their useful operating life and no longer feasible to retain.

12. Review and Approval Process

The following review and approval process was followed for this capital funding request:

Review Step	Reviewer
Review 1	Team Lead of Technical Services, General Supervisor of Business Integration, General Supervisor of Collection Services, General Supervisors of Sustainable Waste Processing, General Supervisors of Technical Services, and Senior Accountant of Financial Services.
Review 2	Director of Finance, Director of Business Integration, Director of Collection Services, Director of Sustainable Waste Processing, Communications, and Director of Technical Services.
Review 3	Branch Manager of Waste Services (Final Approver)
Review 4	Utility Advisor
Review 5	Utility Committee report presented

13. Appendices

Appendix A: Deteriorated Fleet Assets

It's common to have transmission and differential failures on self-propelled equipment and heavy-duty trucks past or near its EUL. A single repair can range between \$50,000 and \$75,000, leaving a unit out of service for up to 6 to 8 weeks.



Figure 1: The torque converter input bearing showing the heat-affected area.



Figure 2: Metal debris from inside the torque converter housing.



Figure 3: Metal contamination inside the transmission.



Figure 4: Damage inside the transmission oil pump.

Appendix B: Replacement Schedule

The following list does not include \$10.8M for units pre-approved in 2022 for the 2023-2026 budget cycle. These units are listed in Appendix D.

Equipment Description	Section	Estimated Cost / Unit	Qty	Estimated Total
2023 Deliveries				
Truck - Tandem Side Loading (Body)	Collections	\$200,000	7	\$1,400,000
Truck - Single Side Loading (Body)	Collections	\$160,000	4	\$640,000
Truck - Haul All	Collections	\$185,000	1	\$185,000
Light Vehicle Truck	Collections / SWP	\$85,000	5	\$425,000
Light Plant	SWP	\$35,000	4	\$140,000
Mobile Crane	SWP	\$200,000	1	\$200,000
Manlift	SWP	\$125,000	2	\$250,000
Trailer End Dump	SWP	\$180,000	4	\$720,000
Trailer Walking Floor	SWP	\$230,000	6	\$1,380,000
Trommel Screener	SWP	\$430,000	1	\$430,000
Truck - Fifth Wheel	SWP	\$230,000	3	\$690,000
Tool Cat	SWP	\$120,000	1	\$120,000
Inflation on above units				\$154,630

Subtotal 2023 Deliveries	\$6,734,630
---------------------------------	--------------------

2024 Deliveries

Truck - Tandem Side Loading (Chassis)	Collections	\$200,000	7	\$1,400,000
Truck - Single Side Loading (Chassis)	Collections	\$160,000	4	\$640,000
Truck - Tandem Side Loading (Body)	Collections	\$200,000	7	\$1,400,000
Truck - Single Side Loading (Body)	Collections	\$160,000	4	\$640,000
Truck - Crane	Collections	\$110,000	1	\$110,000
Truck - Bin Carrier	Collections	\$220,000	1	\$220,000
Light Vehicle Truck	SWP	\$85,000	6	\$510,000
Excavator	SWP	\$800,000	1	\$800,000
Wheel Loader (Large)	SWP	\$800,000	1	\$800,000
Wheel Loader (Small)	SWP	\$500,000	1	\$500,000
Trailer - Walking Floor	SWP	\$230,000	6	\$1,380,000
Truck - Fifth Wheel	SWP	\$230,000	4	\$920,000
Inflation on above units				\$443,187

Subtotal 2024 Deliveries	\$9,763,187
---------------------------------	--------------------

2025 Deliveries

Truck - Tandem Side Loading (Chassis)	Collections	\$200,000	7	\$1,400,000
---------------------------------------	-------------	-----------	---	-------------

Truck - Single Side Loading (Chassis)	Collections	\$160,000	4	\$640,000
Truck - Tandem Side Loading (Body)	Collections	\$200,000	9	\$1,800,000
Truck - Single Side Loading (Body)	Collections	\$160,000	3	\$480,000
Skid-steer	Collections	\$125,000	1	\$125,000
Loader - Telescoping	Collections	\$280,000	1	\$280,000
Truck - Front Loading	Collections	\$450,000	2	\$900,000
Light Vehicle Truck	Collections / SWP	\$85,000	10	\$850,000
Wheel Loader (Large)	SWP	\$800,000	1	\$800,000
Wheel Loader (Small)	SWP	\$500,000	1	\$500,000
Trailer - Walking Floor	SWP	\$230,000	5	\$1,150,000
Inflation on above units				\$644,115

Subtotal 2025 Deliveries **\$9,569,115**

2026 Deliveries

Truck - Tandem Side Loading (Chassis)	Collections	\$200,000	9	\$1,800,000
Truck - Single Side Loading (Chassis)	Collections	\$160,000	3	\$480,000
Excavator	SWP	\$800,000	1	\$800,000

Capital Funding Request WS Fleet Assets

Forklift	Collections	\$100,000	1	\$100,000
Truck - Recycling (Pendpac)	Collections	\$390,000	1	\$390,000
Truck - Roll Off	Collections	\$270,000	2	\$540,000
Light Vehicle Truck	Collections / SWP	\$85,000	8	\$680,000
Trailer - Flat Deck	SWP	\$125,000	3	\$375,000
Truck - Water	SWP	\$450,000	1	\$450,000
Trailer - Walking Floor	SWP	\$230,000	4	\$920,000
Truck - Fifth Wheel	SWP	\$230,000	4	\$920,000
Inflation on above units				\$725,861

Subtotal 2026 Deliveries **\$8,180,861**

TOTAL APPROVAL REQUIRED (with Inflation) **\$34,247,793**

Appendix C: Availability Trends 2020 - 2022

Current Year is 2022 ■ Current Year ■ Previous Year ■ 2 Years Ago

Collections Availability

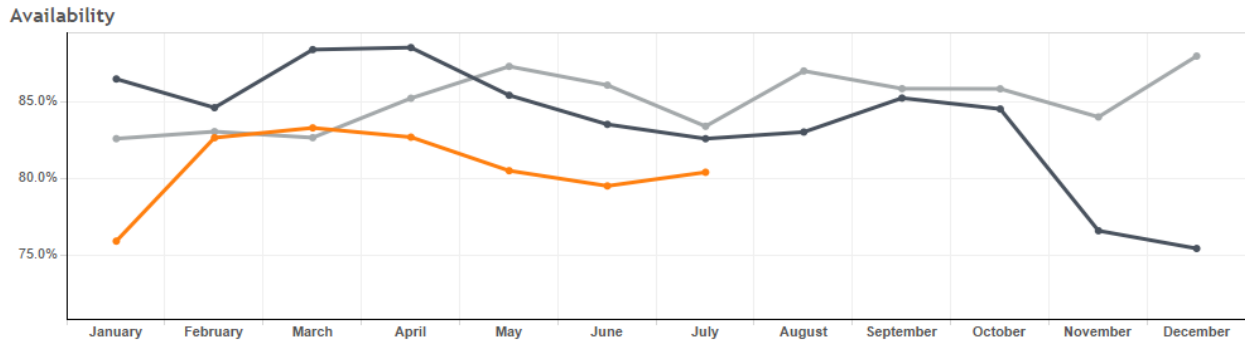

Process and Disposal Availability

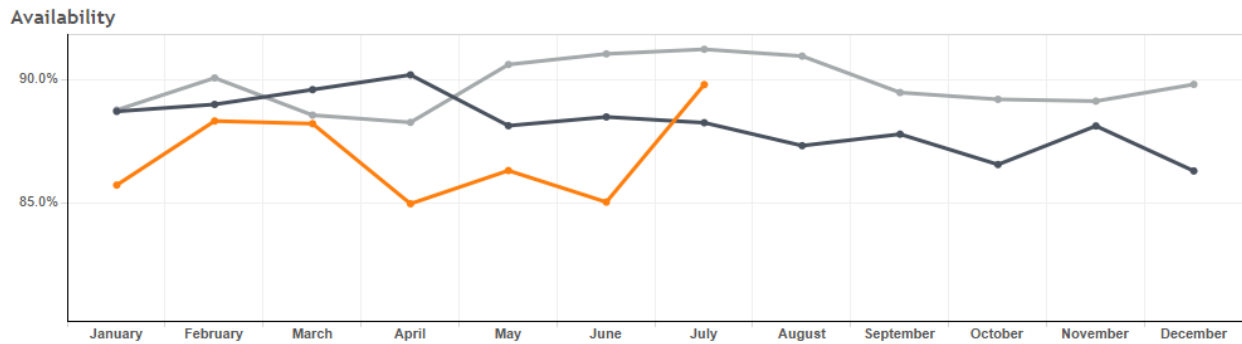

Appendix D: Advanced Commitments

The following units received 2023-2026 budget pre-approval in September 2022 in the CO01381 Waste Services Supplemental Capital Budget Adjustment Council Report to ensure the units could be procured and delivered for 2023 and 2024 replacement requirements.

Equipment Description	Section	Estimated Cost / Unit	Qty	Estimated Total
2023 Deliveries				
Loader - Front End	SWP	\$725,000	2	\$1,450,000
Truck - Front Loading	Collections	\$450,000	3	\$1,350,000
Compost Turner	SWP	\$850,000	1	\$850,000
Truck - Roll Off	Collections	\$270,000	3	\$810,000
Truck - Hook Lift	SWP	\$220,000	2	\$440,000
Truck - Dump	SWP	\$200,000	1	\$200,000
Subtotal 2023 Deliveries				\$5,100,000
2024 Deliveries				
Truck - Front Loading	Collections	\$450,000	11	\$4,950,000
Truck - Recycling (Pendpac)	Collections	\$390,000	2	\$780,000
Subtotal 2024 Deliveries				\$5,730,000
TOTAL PREVIOUSLY APPROVED				\$10,830,000

Appendix E: Financial Analysis Summary

Project Title: Fleet Assets Capital Funding Request	Replace Equipment at End of Useful Life
Total Capital Cost	(\$45,077,793)
Total Revenues	\$0
Total Operating and Maintenance Savings	\$1,420,183
Total Lease Costs	\$0
Project Net Inflows (Outflows)	(\$43,657,610)
WACC Discount Rate	6.28%
Project Cost (Present Value)	(\$38,070,145)

The following table and graph demonstrate the cumulative present value of the revenues that must be realized through annual rate collection to support the project costs. This includes operating and maintenance costs, interest and amortization expenses over the project lifecycle.

**Project Title: Vehicle and Equipment Capital Funding Request
Cumulative Present Value of Revenue Requirement**

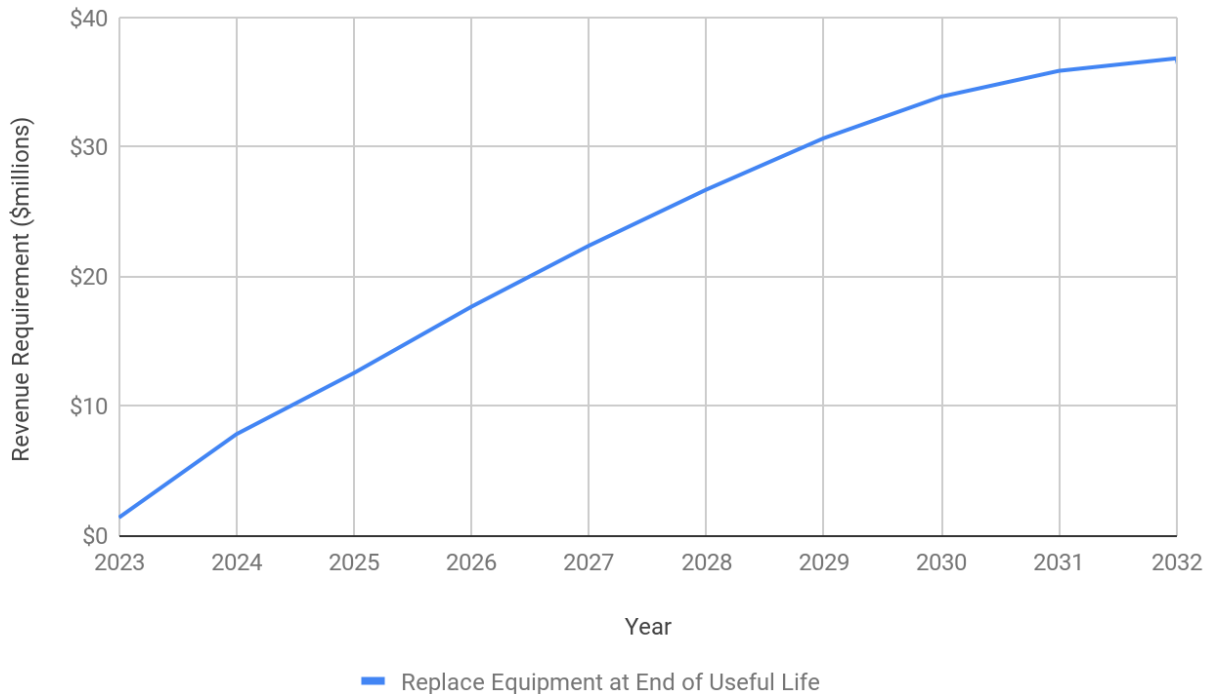

Year	Calendar Year	Replace Equipment at End of Useful Life
1	2023	\$1,370,775
2	2024	\$7,808,566
3	2025	\$12,528,423
4	2026	\$17,647,884
5	2027	\$22,359,825
6	2028	\$26,689,260
7	2029	\$30,659,715
8	2030	\$33,865,696
9	2031	\$35,851,779
10	2032	\$36,818,286

CAPITAL PROFILE REPORT

PROFILE NAME: **WASTE SERVICES FLEET ASSETS**
PROFILE NUMBER: **CM-81-2048**
DEPARTMENT: **Utilities**
LEAD BRANCH: **Waste Services**
PARTNER:
BUDGET CYCLE: **2023-2026**

RECOMMENDED FUNDED

PROFILE STAGE:	Approved
PROFILE TYPE:	Composite
LEAD MANAGER:	Denis Jubinville
PARTNER MANAGER:	
ESTIMATED START:	January, 2023
ESTIMATED COMPLETION:	December, 2026

Service Category:	Utilities	Major Initiative:	
-------------------	-----------	-------------------	--

GROWTH	RENEWAL
10	90

PREVIOUSLY APPROVED:	10,830
BUDGET REQUEST:	34,248
TOTAL PROFILE BUDGET:	45,078

PROFILE DESCRIPTION

Composite profile CM-81-2048 supports the replacement of Fleet Assets (Waste Services Vehicles & Equipment). The approach followed by this profile closely aligns with Edmonton's 25-year Waste Strategy that outlines how the City demonstrates leadership and encourages residents, businesses and institutions to actively participate in better managing their waste and ultimately reducing the amount of waste generated in Edmonton.

With a net replacement value of approximately \$95.1 million, the Waste Services fleet consists of self-propelled equipment, heavy-duty trucks, trailers, light trucks and vehicles. Fleet assets are used to collect, process, recycle and dispose of waste for over 400,000 residential households. Fleet assets physically deteriorate with use and age; timely asset replacement improves the fleet's availability and results in a lower average operating cost per kilometer/hour. Replacement is done by purchasing new units once they reach the end of their useful operating life.

Waste Services requires approximately \$45.1M for the next four-year capital budget cycle to replace fleet assets at the end of their useful lives, of which \$34.3M is requested in this Funding Request and \$10.8M was pre-approved in September 2022 to ensure orders will arrive in 2023-2024 when required. The level of funding requested will enable Waste Services to continue to meet its commitment to provide sustainable waste management services and align with Edmonton's 25-year Waste Strategy

PROFILE BACKGROUND

Waste Services use fleet assets to collect and process waste (garbage, organics and recyclables); these assets have an operating life of five to ten years. Replacing fleet assets ensures higher availability, lower maintenance cost and newer technology that meets the latest emission and fuel efficiency standards. Fleet assets are maintained by in-scope City of Edmonton employees at the Edmonton Waste Management Centre (EWMC) and Kennedale Garage. Fleet assets may require unplanned capital refurbishment based on use and condition; this is done to extend the asset's operating life when deemed economically viable.

Waste Services tracks the performance of fleet assets continuously; one key metric is fleet availability, which generally quantifies the probability that fleet assets are in operational condition. Availability targets for the Waste Fleet are based on equipment class; as of July 2022, overall availability was 84%.

PROFILE JUSTIFICATION

This capital funding request will ensure adequate funding is available to replace Waste Services Fleet Assets as prescribed by Fleet and Facility Services; funding is outlined in the Fleet Assets (Waste Services Vehicles and Equipment) capital profile CM-81-2048.

Urgency of Need:

73.9% of Waste Services fleet assets are within their useful operating life. If capital funding is not approved and fleet assets are not replaced, only 44.1% of the fleet will remain within its useful operating life by year-end 2026. Historical data indicates if fleet assets are not replaced within or at the end of their useful operating life, maintenance and fuel costs increase while levels of service decline. For example, in the chart below for the curbside tandem fleet, the trucks past the 10-year life cycle cost an average of \$59,022 per year. The first three years of operation cost an average of \$22,387 per year. For 10 trucks operating past their 10-year lifecycle, it would cost the City an additional \$366k annually to operate.

Anticipated Outcomes:

Effective asset management will ensure Waste Services have the resources to achieve objectives by aligning vision, mission and strategy with daily activities to achieve goals. Waste Services envisions the following outcomes:
Better information to make capital investment decisions: Through a structured and integrated process, administration will ensure that fleet acquisitions identified as a high priority to Waste Services receive a robust evaluation of alternatives and scope identification.
Improved replacement schedules and budget estimates: Fleet and Facility Services owns a variety of competitive long-term service agreements; this enables acquisitions to be done efficiently with prices that are locked in.
High levels of customer service are delivered in efficient and effective ways through leading-edge waste self-propelled equipment that uses current and emergent technology to enable high rates of diversion of waste from landfill.
Reliable fleet assets that will deliver cost-effective, sustainable waste management.

STRATEGIC ALIGNMENT

This capital funding request contributes to the overall strategic direction of City Council and goals of policies and corporate strategic documents listed in the table below. This contribution is made by demonstrating leadership in waste management and processing standards, and by increasing diversion of waste from landfill.

City of Edmonton Environmental Policy C512
ConnectEdmonton: Vision 2050
Waste Services Business Plan 2022-2025
25 Year Waste Strategy
Waste Services Utility Fiscal Policy C558B
Capital Project Governance Policy C591

ALTERNATIVES CONSIDERED

This is a capital funding request and does not present any alternatives for consideration. This profile is taking a status quo approach (purchasing new vehicles as required) as this was already determined to be the best alternative in the 2019-2022 budget cycle business case.

COST BENEFITS

Tangible:

Higher availability and service levels
Significant savings in fuel and repair costs
Reduced liability
Higher resale values
Improved safety due to less manual labour
Reduction in greenhouse gas emissions

Intangible:

Higher levels of employee satisfaction
Higher levels of customer satisfaction
Higher brand recognition

KEY RISKS & MITIGATING STRATEGY

Risk: Capital funding request is not approved
Mitigating Strategy: Retain existing assets and increase operating budget

Risk: Fleet assets are not replaced on schedule due to long delivery times
Mitigating Strategy: Long-term procurement plan focusing on ordering units with sufficient lead times

Risk: New fleet assets do not meet required service levels (design issues)
Mitigating Strategy: Fleet engineering resources will review the design and function of new acquisitions

Risk: Maintenance backlog (supply chain delays)
Mitigating Strategy: "Stringent warranty clauses with a spare part strategy for critical assets" will be implemented

RESOURCES

The Program Manager of Process Maintenance Operations and Fleet will act as the customer liaison for Fleet Asset acquisitions on behalf of Waste Services. A Project Engineer will develop equipment specifications and purchasing documents to work directly with suppliers.

CONCLUSIONS AND RECOMMENDATIONS

Conclusion:

Fleet asset replacement, as scheduled, will ensure vehicle availability, reliability, and safety. Approving this Capital Funding Request will authorize \$34.3M of fleet replacement for the 2023-2026 budget cycle.

Recommendation:

It is recommended that the capital funding for this profile be approved as it closely aligns with Edmonton's 25-year Waste Strategy that ensures Edmontonians receive maximum environmental benefits while minimizing the cost increases of managing solid waste. Approval of this Capital Funding Request will authorize \$34,247,793 retained earnings funding for vehicles and equipment (which does not include the \$10,830,000 already approved in September 2022).

CAPITAL PROFILE REPORT

PROFILE NAME: **Waste Services Fleet Assets**
 PROFILE NUMBER: **CM-81-2048**
 BRANCH: **Waste Services**

RECOMMENDED FUNDED
 PROFILE TYPE: **Composite**

CAPITAL BUDGET AND FUNDING SOURCES (000's)

APPROVED BUDGET		Prior Years	2022	2023	2024	2025	2026	2027	2028	2029	2030	Beyond 2030	Total
	Approved Budget												
	Original Budget Approved	-	-	-	-	-	-	-	-	-	-	-	-
	2022 Cap Budget Request for Next Cycle	-	-	5,100	5,730	-	-	-	-	-	-	-	10,830
	Current Approved Budget	-	-	5,100	5,730	-	-	-	-	-	-	-	10,830
Approved Funding Sources													
	Waste Mgt Retained Earnings	-	-	5,100	5,730	-	-	-	-	-	-	-	10,830
	Current Approved Funding Sources	-	-	5,100	5,730	-	-	-	-	-	-	-	10,830

BUDGET REQUEST	Budget Request	-	-	6,735	9,763	9,569	8,181	-	-	-	-	-	34,248
	Revised Funding Sources (if approved)												
	Waste Mgt Retained Earnings	-	-	6,735	9,763	9,569	8,181	-	-	-	-	-	34,248
	Requested Funding Source	-	-	6,735	9,763	9,569	8,181	-	-	-	-	-	34,248

REVISED BUDGET (IF APPROVED)	Revised Budget (if Approved)	-	-	11,835	15,493	9,569	8,181	-	-	-	-	-	45,078
	Requested Funding Source												
	Waste Mgt Retained Earnings	-	-	11,835	15,493	9,569	8,181	-	-	-	-	-	45,078
	Requested Funding Source	-	-	11,835	15,493	9,569	8,181	-	-	-	-	-	45,078

CAPITAL BUDGET BY ACTIVITY TYPE (000's)

REVISED BUDGET (IF APPROVED)	Activity Type	Prior Years	2022	2023	2024	2025	2026	2027	2028	2029	2030	Beyond 2030	Total
		Fleet Equipment	-	-	11,835	15,493	9,569	8,181	-	-	-	-	-
	Total	-	-	11,835	15,493	9,569	8,181	-	-	-	-	-	45,078

OPERATING IMPACT OF CAPITAL

Type of Impact:

Branch:																
	Rev	Exp	Net	FTE	Rev	Exp	Net	FTE	Rev	Exp	Net	FTE	Rev	Exp	Net	FTE
Total Operating Impact	-	-	-	-	-	-	-	-	-	-	-	-	-	-	-	-

CAPITAL PROFILE REPORT

PROFILE NAME: Waste Services Fleet Assets			
PROFILE NUMBER: CM-81-2048			
BUDGET CYCLE: 2023-2026			
Project Number	Project Name	Description	Percentage Funded
230001	Equipment Acquisition - Collections	Equipment Acquisition - Collections	100
230002	Equipment Acquisition - SWP	Equipment Acquisition - SWP	100

CAPITAL PROFILE REPORT

PROFILE NAME: **LANDFILL GAS TO RENEWABLE NATURAL GAS (RNG)**

RECOMMENDED FUNDED

PROFILE NUMBER: **22-81-2053**

PROFILE STAGE: **Approved**

DEPARTMENT: **Utilities**

PROFILE TYPE: **Standalone**

LEAD BRANCH: **Waste Services**

LEAD MANAGER: **Michael Labrecque**

PROGRAM NAME:

PARTNER MANAGER:

PARTNER:

ESTIMATED START: **January, 2021**

BUDGET CYCLE: **2023-2026**

ESTIMATED COMPLETION: **December, 2023**

Service Category: Utilities		Major Initiative:	
GROWTH	RENEWAL	PREVIOUSLY APPROVED:	16,670
100		BUDGET REQUEST:	-3,302
		TOTAL PROFILE BUDGET:	13,368

PROFILE DESCRIPTION

The Landfill Gas to Renewable Natural Gas Project (Project) was developed to look for environmentally sustainable and financially attractive solutions for post-2024 LFG management. The proposed initiative focuses on LFG to RNG upgrade. Fulfillment of this initiative will require the construction of RNG upgrading infrastructure for generation and interjection of RNG into the natural gas network. This project will be the first-of-its-kind project in Alberta to upgrade the LFG to RNG and sell the RNG as a commodity to the local, provincial and/or national market.

While there are several market-ready technologies available for the upgrading of LFG to RNG, this project will use the pressure swing adsorption method for the following reasons:

- It is proven, mature and reliable;
- It demonstrates high conversion yield (up to 98% of methane is conserved during LFG to RNG conversion);
- It is well suited for the quality of LFG found in Clover Bar Landfill;
- It has a lower life cycle cost when compared to other existing upgrading technologies; and
- It generates low residual waste by-products which are mostly inert in nature (spent adsorbing media).

Collected LFG is directed to a gas conditioning system where major impurities such as water, siloxane, ammonia, and H₂S are removed from the stream. Conditioned gas is then fed into a pressure swing adsorption (PSA) upgrading unit consisting of a series of vertical towers where one-half of the towers operate at high pressure and the other half operate at low pressure. These vessels are connected by a complex network of piping and valves to switch the gas flow between the towers. Each tower is filled with an adsorption medium through which the gas permeates. As the gas flows from one vessel to another one, it swings from a high to a low-pressure environment. When in a high-pressure environment the CO₂ and the other impurities are adsorbed and then released to the ambient at low pressure. The exit gas stream is at least 95% clean methane in its composition that is suitable for use as RNG. Gaseous impurities such as ammonia and H₂S are adsorbed on adsorption media. Condensate is collected and disposed of at the Wastewater Treatment Plant, or equivalent licensed facility. Adsorption media when enriched is replaced with the old media being regenerated or disposed of at a licensed facility (typically class 2 landfill).

The entire LFG to RNG upgrading system comes pre-fabricated. A footprint of a typical LFG to RNG upgrading facility is approximately 3,600 m². Within this footprint, there are both (i) LFG conditioning and removal of impurities module (ii) a module for LFG upgrading to produce RNG of pipeline quality, (iii) a flare, and (iv) injection station. Appropriate land meeting these requirements has been identified at the Edmonton Waste Management Centre (EWMC) along with adequate utility supplies.

PROFILE BACKGROUND

A landfill gas collection system has been in place since 1992, and is currently owned and managed by Capital Power under a collaboration contract, until 2024. To prepare for the City to take back control of the LFG obligation and management as soon as the existing contract expires, WS completed a condition assessment, which confirmed that the system requires complete upgrades in order to meet the minimum environmental obligations under the Environmental Protection and Enhancement Act. This means the City will need to invest \$7.3 million to upgrade the landfill gas collection as well as the flare system, by 2024. This work has been captured in the Clover Bar Landfill Liability, through an increase to the landfill liability in 2019.

Under the current operational conditions, the landfill gas collection system also generates greenhouse gas (GHG) offset compliance credits. The GHG offset credit agreement with CP (different from the collaboration agreement) is valid until August 2023. GHG offset compliance credits are those that have been generated and quantified by voluntary project developer under Technology Innovation and Emissions Reduction (TIER) regulation.

PROFILE JUSTIFICATION

The technology to convert LFG to renewable natural gas (RNG) is mature as evidenced by many successful projects fully operational globally (please see USEPA RNG Project Map) . The government commitment to greenhouse gas emission reduction has created a high demand on the "green" energy market. The demand has been further enhanced by more and more responsible energy consumers who voluntarily purchase green energy. To fully leverage City owned LFG resource and invest in a capital project that generates revenue creates a unique investment opportunity that also fits well with the City's strategic direction.

The expiration of the existing contractual agreements in 2024, along with the expiry of the GHG compliance offset credit agreement in 2023, results in an opportunity to improve the beneficial use of the landfill gas post 2024 while continuing to manage the environmental liability associated with the approval to operate CBLF. In the spring of 2020, Waste Services secured a \$10 million grant from Emissions Reductions Alberta (ERA) to upgrade the LFG to renewable natural gas. A key stipulation of the \$10 million grant is for the City to partner with the current LFG collection system operator, Capital Power.

RNG is a form of non-fossil carbon-neutral energy that is interchangeable with conventional natural gas, can be injected into the natural gas distribution system, and reduces the amount of conventional natural gas by replacing it with gas from a renewable source. From a recent engineering study by Jacobs (2018) on the quantity and flow rate of available LFG, it is estimated that the CBLF could produce an average of 245,000 GJ per year of RNG, for at least another 20 years. Based on expectations of the RNG market, this opportunity will add annual revenue to the Utility of \$3 million. An overview of the RNG market can be found in section 5, Context Analysis.

Over the next three years, there will be major activities around CBLF with a direct influence on this Project. The first is the final closure of the landfill and its transition into post-closure monitoring and management. The construction of closure activities is slated for the second quarter of 2021. Concurrent construction of collection system upgrades is planned as it will result in reduced cost of this undertaking by eliminating repetitive ground disturbance works as well as double payment for mobilization and demobilization activities.

Furthermore, the \$10 million grant provided by Emissions Reduction Alberta requires the grant holder to implement the project before September 2023, which is three years from the date of the grant award. Any extension to this schedule may jeopardize the receipt of the grant which is a significant offset to overall project costs.

Finally, the existing LFG management arrangement with Capital Power will last until August 2024 after which the control over LFG will be transferred to Waste Services. Although WS has the first right of refusal to purchase the existing LFG management infrastructure, it is not known what the fair price of that infrastructure would be. Also, the feasibility of purchasing this infrastructure is questionable given its condition and required minimum time horizon for its post-closure liability service.

Starting the planning, design and upgrading of the landfill gas collection system, and a flare station are mandatory activities in order to meet the minimum regulatory requirement. Also to embrace the opportunity to convert the collected landfill gas to renewable natural gas and sell it on the market as a commodity will give the project significant financial benefits.

The total capital cost is estimated to be \$16.7 million. Although the total capital cost of the project is \$16.7 million, the City will fund \$2.7 million. The remaining \$14 million will be funded externally, with \$10 million coming from the Emissions Reductions Alberta grant and \$4 million from Capital Power.

STRATEGIC ALIGNMENT

The City Plan has two goals that are addressed by the project. By investing in technology focuses on renewable energy generation, Edmonton will be a healthy city, progress towards a low carbon future and continue toward its path of Climate Resilience.

The Community Energy Transition Strategy is Edmonton's plan to address and mitigate climate change through the reduction of GHG emissions, increasing efficiency and promoting renewable energy systems. Investing in the Project will result in a reduction of the overall GHG emissions from the CBLF added benefit of producing renewable energy.

ALTERNATIVES CONSIDERED

There are three alternatives presented in the Business Case. It is worth noting that Waste Services has engaged a consultant for a more comprehensive review for all possible options in developing a LFG to RNG facility. This included 30 different scenarios which ultimately was narrowed down into 3 alternatives that is presented here.

Alternative 1 (Status Quo) - this alternative foregoes building a LFG-to-RNG facility. The facility is not mandatory for WS to meet its environmental liabilities associated with CBLF. As such, this alternative provides analysis on what the O&M cost and NPV are compared to building a LFG-to-RNG facility.

Alternative 2 - includes a shared ownership model for the LFG to RNG initiative. The ownership of the upgrader would be split between Capital Power and the City. This is the preferred alternative.

Alternative 3 - involves full capital investment by the City to maintain maximum strategic independence, operational control, and business flexibility.

COST BENEFITS

The Project produces two key, revenue-generating outputs:

- RNG, to be injected and blended into the local natural gas system
- GHG emissions offsets, to be quantified, reported and verified annually thus producing offsets eligible under Alberta's existing Carbon Competitiveness Incentive Regulation (CCIR) and the new Technology Innovation and Emissions Reductions Regulation (TIER), or a voluntary offset program.

KEY RISKS & MITIGATING STRATEGY

Key risks & mitigation strategy:

Fluctuating LFG quality & quantity

- Measure LFG quality & quantity on at least a monthly basis to assess fluctuation & degradation in flow
- Additional LFG sampling efforts required in order to minimize risk to the City
- Ensure RNG upgrader has built in capacity to turn down LFG flows

Failure to meet RNG injection specifications (due to high nitrogen, oxygen or CO2)

- Implement a robust biogas upgrading technology capable of exceeding RNG injection specification requirements
- Enhance operational planning
- Improve collection efficiency

Revenue fluctuation

- Secure long-term contracts for a guaranteed RNG Price
- Consider the worst case scenario for all cost benefit analyses
- Start discussions with off-takers earlier in the project

RESOURCES

CoE will provide overall direction, guidance, and approval for the lifecycle of the project. Waste Services will lead the project team as well as full budgetary control on this project and be the official recipient of the ERA grant. Contract management will be led by Waste Services staff.

CONCLUSIONS AND RECOMMENDATIONS

To deliver this project for the construction of the Landfill Gas to Renewable Natural Gas facilities, a total capital investment of \$16.7 million is required. By entering a partnership with CP, the true required capital funding for the City of Edmonton is \$2.7 million. Accomplishing this project will further translate in the following for the WS:

- Significant reduction in environmental risks due to LFG management system failure;
- Net positive cash flow to business area over project's lifespan;

It is recommended that this Business Case is approved and authorized following Alternative 2 for Capital Expenditure (Funding Approval) of \$2.7 million within the 2019-2022 budget. The approval of this Business Case will enter the project to the Delivery Phase in 2021-2023.

CAPITAL PROFILE REPORT

PROFILE NAME: **Landfill Gas to Renewable Natural Gas (RNG)**

RECOMMENDED FUNDED

PROFILE NUMBER: **22-81-2053**

PROFILE TYPE: **Standalone**

BRANCH: **Waste Services**

CAPITAL BUDGET AND FUNDING SOURCES (000's)

	Prior Years	2022	2023	2024	2025	2026	2027	2028	2029	2030	Beyond 2030	Total
APPROVED BUDGET	Approved Budget											
	Original Budget Approved	-	-	-	-	-	-	-	-	-	-	-
	2021 Cap Capital Budget Adj (one-off)	670	10,800	5,200	-	-	-	-	-	-	-	16,670
	2021 Cap Carry Forward	-670	670	-	-	-	-	-	-	-	-	-
	Current Approved Budget	-	11,470	5,200	-	-	-	-	-	-	-	16,670
	Approved Funding Sources											
	Partnership Funding	-	3,000	1,000	-	-	-	-	-	-	-	4,000
	Provincial Grant	-	7,000	3,000	-	-	-	-	-	-	-	10,000
	Waste Mgt Retained Earnings	-	1,470	1,200	-	-	-	-	-	-	-	2,670
	Current Approved Funding Sources	-	11,470	5,200	-	-	-	-	-	-	-	16,670

BUDGET REQUEST	Budget Request	-	-	-5,300	1,998	-	-	-	-	-	-	-3,302
	Revised Funding Sources (if approved)											
	Partnership Funding	-	-	-4,000	-	-	-	-	-	-	-	-4,000
	Provincial Grant	-	-	-3,000	-	-	-	-	-	-	-	-3,000
	Self-Liquidating Debentures	-	-	1,700	1,998	-	-	-	-	-	-	3,698
Requested Funding Source	-	-	-5,300	1,998	-	-	-	-	-	-	-3,302	

REVISED BUDGET (IF APPROVED)	Revised Budget (if Approved)	-	11,470	-100	1,998	-	-	-	-	-	-	13,368
	Requested Funding Source											
	Partnership Funding	-	3,000	-3,000	-	-	-	-	-	-	-	-
	Provincial Grant	-	7,000	-	-	-	-	-	-	-	-	7,000
	Self-Liquidating Debentures	-	-	1,700	1,998	-	-	-	-	-	-	3,698
	Waste Mgt Retained Earnings	-	1,470	1,200	-	-	-	-	-	-	-	2,670
Requested Funding Source	-	11,470	-100	1,998	-	-	-	-	-	-	13,368	

CAPITAL BUDGET BY ACTIVITY TYPE (000's)

	Activity Type	Prior Years	2022	2023	2024	2025	2026	2027	2028	2029	2030	Beyond 2030	Total
REVISED BUDGET (IF APPROVED)	Other Costs	-	11,470	-100	1,998	-	-	-	-	-	-	-	13,368
	Total	-	11,470	-100	1,998	-	-	-	-	-	-	-	13,368

OPERATING IMPACT OF CAPITAL

Type of Impact:

Branch:																
	Rev	Exp	Net	FTE	Rev	Exp	Net	FTE	Rev	Exp	Net	FTE	Rev	Exp	Net	FTE
Total Operating Impact	-	-	-	-	-	-	-	-	-	-	-	-	-	-	-	-

CAPITAL PROFILE REPORT

PROFILE NAME:	HIGH SOLIDS ADF - DIGESTATE SCREENING AND MIXING SYSTEM	RECOMMENDED
PROFILE NUMBER:	23-81-3060	PROFILE STAGE: Council Review
DEPARTMENT:	Integrated Infrastructure Services	PROFILE TYPE: Standalone
LEAD BRANCH:	Infrastructure Planning and Design	LEAD MANAGER: Pascale Ladouceur
PARTNER:	Waste Services	PARTNER MANAGER: Denis Jubinville
BUDGET CYCLE:	2023-2026	ESTIMATED START: January, 2023
		ESTIMATED COMPLETION: December, 2024

Service Category:	Utilities	Major Initiative:
--------------------------	------------------	--------------------------

GROWTH	RENEWAL	PREVIOUSLY APPROVED:	-
	100	BUDGET REQUEST:	5,800
		TOTAL PROFILE BUDGET:	5,800

PROFILE DESCRIPTION

The High Solids Anaerobic Digestion Facility (HSADF) at the Edmonton Waste Management Centre (EWMC) was designed to process up to 40,000 tonnes of a combination of source-separated organics and the organic fraction of municipal solid waste. The recommended screening and mixing system consists of two screens and two mixers in the facility to remove non-organic foreign material (garbage) from the compost prior to outdoor windrowing at EWMC. This screening and mixing system is the best successor to the old Finishing Circuit in the now demolished Composting Facility. The new screening and mixing system will help the City increase the quality of the compost created and manage the current litter problem at the cure site and in the neighbouring wetland. In addition, the system will allow for the reuse of woodchips back into the process, reducing usable material to landfill.

PROFILE BACKGROUND

The HSADF uses microorganisms to degrade the organic waste without oxygen and produces biogas and nutrient-rich semi-solid digestate. The digestate is further processed in the facility's aeration boxes to produce compost. The High Solids Anaerobic Digestion Facility relied on the Edmonton Composting Facility for important processing steps (specifically screening). With the decommissioning and demolition of the Edmonton Composting Facility, further investment into the overall process is required, such as the screening and mixing system project.

PROFILE JUSTIFICATION

The goal of the facility's digestate screening and mixing system is to screen the digestate indoors, thereby reducing the amount of litter from dispersing on and off site. Screening early in the process will reduce costs related to processing non-organic material (such as film plastic) and help fully utilize the systems capacity. The mixers will efficiently mix woodchips with the digestate and allow for the reuse of two thirds of the woodchips into the process. Adding screening and mixing will result in a higher quality of compost. If the compost is contaminated by not screening it properly, it has restricted end uses with an associated fee. The screened compost will allow for a broader variety of uses and will likely open up the opportunity to sell into different markets such as agricultural lands, residential gardens, horticultural operations, the nursery industry and other businesses.

STRATEGIC ALIGNMENT

This project aligns with ConnectEdmonton and the 25-Year Waste Strategy by ensuring that food waste is processed responsibly and the amount landfilled is minimized.

ALTERNATIVES CONSIDERED

HSADF Digestate Screening and Mixing System Business Case contemplates five alternatives, two of which were considered viable. The viable options considered were netting the cure site and adding a trommel screen in the HSAD (Option 2) or adding two screeners and two mixers in the HSAD (Option 4). As outlined in the Business Case, Option 2 was found to have a lower total cost of \$6.7 million (in present value) compared to \$7.5 million (in present value) for Option 4. The costs for Option 4 were higher due to higher operating costs associated with this option.

The current capital estimate for Option 4 is \$5.8 million starting in 2022 with the majority of the costs being incurred in 2023.

COST BENEFITS

The program is focused on reducing the amount of waste going to the landfill and reducing the litter problem. This project will expand the organic waste processing capabilities and contribute to the 25-Year Waste Strategy's goal of diverting 90% of waste from landfill.

KEY RISKS & MITIGATING STRATEGY

Challenge: Economical - The equipment suppliers have different technologies that could meet the City's requirements but at varied price points. In addition, fluctuating exchange rates and escalation (in part due to COVID-19) may affect the cost estimation of this project.

RESOURCES

Dedicating Integrated Infrastructure Services (IIS) resources to the project will or has occurred. No additional operating personnel within the facility will be recruited.

CONCLUSIONS AND RECOMMENDATIONS

The screening and mixing system consists of two screens and two mixers to remove non-organic foreign material (garbage) from the compost prior to outdoor windrowing at the EWMC Cure Site. This system is the best successor to the old Finishing Circuit in the now demolished Edmonton Composting Facility and will help the City increase the quality of the compost created, manage the current litter problem at the cure site and in the neighbouring wetland, and allow for the reuse of woodchips back into the process, reducing usable material to landfill. Status quo, or doing nothing, is not a practical option as continued cure site littering is considered a significant environmental problem and a potential regulatory non-compliance that can't be ignored.

CAPITAL PROFILE REPORT

PROFILE NAME: **High Solids ADF - Digestate Screening and Mixing System**

RECOMMENDED

PROFILE NUMBER: **23-81-3060**

PROFILE TYPE: **Standalone**

BRANCH: **Infrastructure Planning and Design**

CAPITAL BUDGET AND FUNDING SOURCES (000's)

APPROVED BUDGET		Prior Years	2022	2023	2024	2025	2026	2027	2028	2029	2030	Beyond 2030	Total
	Approved Budget	Original Budget Approved	-	-	-	-	-	-	-	-	-	-	-
	Current Approved Budget	-	-	-	-	-	-	-	-	-	-	-	-

BUDGET REQUEST	Budget Request	-	-	5,800	-	-	-	-	-	-	-	-	5,800
	Revised Funding Sources (if approved)												
	Self-Liquidating Debentures	-	-	5,800	-	-	-	-	-	-	-	-	5,800
	Requested Funding Source	-	-	5,800	-	-	-	-	-	-	-	-	5,800

REVISED BUDGET (IF APPROVED)	Revised Budget (if Approved)	-	-	5,800	-	-	-	-	-	-	-	-	5,800
	Requested Funding Source												
	Self-Liquidating Debentures	-	-	5,800	-	-	-	-	-	-	-	-	5,800
	Requested Funding Source	-	-	5,800	-	-	-	-	-	-	-	-	5,800

CAPITAL BUDGET BY ACTIVITY TYPE (000's)

REVISED BUDGET (IF APPROVED)	Activity Type	Prior Years	2022	2023	2024	2025	2026	2027	2028	2029	2030	Beyond 2030	Total
	Construction	-	-	5,700	-	-	-	-	-	-	-	-	-
Design	-	-	100	-	-	-	-	-	-	-	-	-	100
	Total	-	-	5,800	-	-	-	-	-	-	-	-	5,800

OPERATING IMPACT OF CAPITAL

Type of Impact:

Branch:																
	Rev	Exp	Net	FTE	Rev	Exp	Net	FTE	Rev	Exp	Net	FTE	Rev	Exp	Net	FTE
Total Operating Impact	-	-	-	-	-	-	-	-	-	-	-	-	-	-	-	-

CAPITAL PROFILE REPORT

PROFILE NAME: CURE SITE LAND USE & DEVELOPMENT

**RECOMMENDED
FUNDED**

PROFILE NUMBER: 15-33-2025

PROFILE STAGE: **Approved**

DEPARTMENT: **Integrated Infrastructure Services**

PROFILE TYPE: **Standalone**

LEAD BRANCH: **Infrastructure Planning and Design**

LEAD MANAGER: **Pascale Ladouceur**

PARTNER: **Waste Management Services**

PARTNER MANAGER: **Michael Labrecque**

BUDGET CYCLE: **2015-2018**

ESTIMATED START: **January, 2015**

ESTIMATED COMPLETION: **December, 2022**

Service Category: **Utilities**

Major Initiative:

GROWTH	RENEWAL
100	

PREVIOUSLY APPROVED:	7,070
BUDGET REQUEST:	-6,244
TOTAL PROFILE BUDGET:	826

PROFILE DESCRIPTION

This initiative consists of the identification of a suitable cure site external to the EWMC, the procurement of land, potential rezoning and subsequent development of the land to meet provincial regulatory standards.

Projected activities:

2015: Identify & screen external sites for size, accessibility, hydrogeologic suitability, zoning, cost, etc., which also include the possibility of partnering with regional jurisdictions interested in using the City's organics processing services in exchange for partnering in the development of a cure site. The evaluation of potential sites will be a follow up to initial discussions with Strathcona County and the Leduc Regional Waste Management Authority.

2016/17: site procurement, any required rezoning, site design and receipt of regulatory approval from Alberta Environment and Sustainable Resource Development. Obtain support from Corporate Properties Branch for site procurement as required.

2017: site construction and development.

PROFILE BACKGROUND

When the Edm Composting Facility (ECF) was purchased in 2001, the outdoor space was developed to provide an attendant cure site. The existing cure site's operation has been maximized by using larger size turning equip and stockpiling unscreened compost atop Clover Bar Landfill for final capping and revegetation. With that process scheduled to be completed, that option will no longer exist. Additional cure site capacity is required to alleviate the problem of the back-end throughput of not matching the front-end processing capacity of the ECF. Without a larger land base, this situation will be exacerbated further when the planned Anaerobic Digestion Facility (ADF) is commissioned in 2017. There is no option to a curing and finishing operation to produce a compost that is both safe & capable of supporting plant growth. Compost must cure for 2 to 6 months at cooler process temperatures to be fully transformed into mature compost as required.

PROFILE JUSTIFICATION

The procurement and development of an external cure site for composting activities (curing, screening, stockpiling and marketing) is required so that the full processing capacity of the City's organics processing facilities (ECF and ADF) can be realized.

Additional curing capacity will:

- ensure that more residential and non-residential organic waste is diverted from landfill;
- manage projected increases in both residential and non-residential organic waste produced by a growing population;
- allow the Waste Management Utility to partner with interested municipal jurisdictions in the Edmonton region to process organic material.

STRATEGIC ALIGNMENT

It aligns with the goals and objectives of The Way We Green, specifically the increase in diversion of waste from landfill (Objectives 8.1 & 8.2) & through composting, the reduction in greenhouse gas emissions (Objectives 6.10 and 6.11).

ALTERNATIVES CONSIDERED

Alternatives are:

1. Develop remote cure site.
2. Landfill more of the organic waste received by the City.
3. Direct organic waste to biofuels production.

See Pg 9 -11 of the attached Business Case for detail analysis.

COST BENEFITS

- The development & operation of a remote curing site represents the lowest lifecycle cost option consistent with achieving the City's goals in organics and waste diversion.
- Potential to sell the add'l organics processing capacity to business sector & other jurisdictions which could generate up to \$650K/year.
- Reduced Greenhouse Gas emissions related to composting versus landfill disposal.

KEY RISKS & MITIGATING STRATEGY

Key Risk

- (1) Inability to negotiate agreement with another jurisdiction
- (2) Preferred site too costly to procure
- (3) Timeline risks: inability to fully complete cure site initiative

Mitigation & detail - see pg 14 of attached Business Case

RESOURCES

An internal team consisting of a proj. eng with input from staff for managing the organics processing operation. If needed, support from other depts carrying out their normal function. External consulting and contracting services will be tendered.

CONCLUSIONS AND RECOMMENDATIONS

It is recommended that an external cure site be approved. In addition, before proceeding with any property acquisition or agreement for land use in an adjacent jurisdiction, Utility Committee will receive a report describing the proposed solution.

CHANGES TO APPROVED PROFILE

#17-4 Admin (CM): During the detailed design phase, additional cost impacts were discovered which were not initially identified by the Contractor. As a result, the total project estimate has increased to \$38,977K and the capital budget requirement has increased by \$1,983K, in order to maintain the current project schedule to complete the project.

CAPITAL PROFILE REPORT

PROFILE NAME: **Cure Site Land Use & Development**
 PROFILE NUMBER: **15-33-2025**
 BRANCH: **Infrastructure Planning and Design**

RECOMMENDED FUNDED
 PROFILE TYPE: **Standalone**

CAPITAL BUDGET AND FUNDING SOURCES (000's)

	Prior Years	2022	2023	2024	2025	2026	2027	2028	2029	2030	Beyond 2030	Total
APPROVED BUDGET												
Approved Budget												
Original Budget Approved	9,000	-	-	-	-	-	-	-	-	-	-	9,000
2015 Cap Carry Forward	-	-	-	-	-	-	-	-	-	-	-	-
2016 Cap Carry Forward	-	-	-	-	-	-	-	-	-	-	-	-
2017 Cap Capital Budget Adj (one-off)	-1,983	-	-	-	-	-	-	-	-	-	-	-1,983
2017 Cap Carry Forward	-	-	-	-	-	-	-	-	-	-	-	-
2018 Cap Budget Request for Next Cycle	3,675	2,925	-	-	-	-	-	-	-	-	-	6,600
2018 Cap Release to Corp Pool	-6,547	-	-	-	-	-	-	-	-	-	-	-6,547
2019 Cap Carry Forward	-	-	-	-	-	-	-	-	-	-	-	-
2020 Cap Carry Forward	-	-	-	-	-	-	-	-	-	-	-	-
2021 Cap Carry Forward	-3,319	3,319	-	-	-	-	-	-	-	-	-	-
Current Approved Budget	826	6,244	-	-	-	-	-	-	-	-	-	7,070
Approved Funding Sources												
Self-Liquidating Debentures	826	6,244	-	-	-	-	-	-	-	-	-	7,070
Current Approved Funding Sources	826	6,244	-	-	-	-	-	-	-	-	-	7,070

BUDGET REQUEST	Budget Request	-	-6,244	-	-	-	-	-	-	-	-	-	-6,244
	Revised Funding Sources (if approved)												
	Self-Liquidating Debentures	-	-6,244	-	-	-	-	-	-	-	-	-	-6,244
	Requested Funding Source	-	-6,244	-	-	-	-	-	-	-	-	-	-6,244

REVISED BUDGET (IF APPROVED)	Revised Budget (if Approved)	826	-	-	-	-	-	-	-	-	-	-	826
	Requested Funding Source												
	Self-Liquidating Debentures	826	-	-	-	-	-	-	-	-	-	-	826
	Requested Funding Source	826	-	-	-	-	-	-	-	-	-	-	826

CAPITAL BUDGET BY ACTIVITY TYPE (000's)

	Activity Type	Prior Years	2022	2023	2024	2025	2026	2027	2028	2029	2030	Beyond 2030	Total
REVISED BUDGET (IF APPROVED)													
	Construction	826	-	-	-	-	-	-	-	-	-	-	826
	Total	826	-	-	-	-	-	-	-	-	-	-	826

OPERATING IMPACT OF CAPITAL

Type of Impact:

Branch:																
	Rev	Exp	Net	FTE	Rev	Exp	Net	FTE	Rev	Exp	Net	FTE	Rev	Exp	Net	FTE
Total Operating Impact	-	-	-	-	-	-	-	-	-	-	-	-	-	-	-	-

CAPITAL PROFILE REPORT

PROFILE NAME:	MAYFIELD ECO STATION (NW)	FUNDED
PROFILE NUMBER:	15-33-2011	PROFILE STAGE: Previously Approved
DEPARTMENT:	Integrated Infrastructure Services	PROFILE TYPE: Standalone
LEAD BRANCH:	Infrastructure Planning and Design	LEAD MANAGER: Pascale Ladouceur
PROGRAM NAME:		PARTNER MANAGER: Michael Labrecque
PARTNER:	Waste Management Services	ESTIMATED START: January, 2015
BUDGET CYCLE:	2023-2026	ESTIMATED COMPLETION: January, 2020

Service Category:	Utilities	Major Initiative:	
-------------------	-----------	-------------------	--

GROWTH	RENEWAL	PREVIOUSLY APPROVED:	19,579
100		BUDGET REQUEST:	-
		TOTAL PROFILE BUDGET:	19,579

PROFILE DESCRIPTION

The construction of an Eco Station in northwest Edmonton to replace the existing Coronation Eco Station will meet the demand for drop-off services for HHW, recycling and bulky waste in the expanding north and northwest areas of the City. This business case establishes the need to expand the current Coronation Eco Station and/or relocate the facility. This preliminary report contains rough estimates for the project based on experience gained through the Ambleside and Kennedale Eco Stations, with funding request in the current 2015-2018 capital budget to secure the land acquisition and provide for detailed design of the facility.

PROFILE BACKGROUND

Operations at the Coronation Eco Station are congested, leading to long wait times and traffic lineups. With increasing population and service demands, redevelopment on a larger site, along with the relocation to the northwest quadrant of the City on a site currently held by Land Enterprise, would offer enhanced services to north and northwest residents. This capital profile seeks to secure the land for Waste Management and funding to facilitate detailed design and further analysis of the program at Coronation.

PROFILE JUSTIFICATION

An expanded NW Eco Station will improve service delivery to residents, reduce wait times, enhance worker safety and provide additional services not available at the current Coronation location. The City of Edmonton currently has a property that appears to meet all current requirements and is projected to be surplus. Securing this property for the Waste Management Utility allows the Utility to time the actual construction with customer demand over the next few years. In accordance with the City's policy regarding land transfer pricing between the City and Utilities, it is apparent that purchase of the land at this time would limit the risk of future price escalation for the Utility. Approval in principle for this project will facilitate the land requirement (payment for the land at fair market value over a four-year period) pending further planning and construction. The City of Edmonton Land Enterprises would have to agree to this payment structure as identified.

STRATEGIC ALIGNMENT

Aligns with certain goals/objectives of the City of Edmonton Waste Management Policy C527, the Utility's 2015-2018 Business Plan, Utility Fiscal Policy C558, City of Edmonton Environmental Policy C512 and "The Way We Green and Live".

ALTERNATIVES CONSIDERED

1. Approve NW Eco Station relocation.
2. Renovate existing Coronation site
3. Increase operating hours to accommodate user demand
4. Do nothing
5. Increase Big Bin Events to manage materials
6. Open additional NW location

COST BENEFITS

Alternative 1 has the highest net cost of annual operations but also the highest number of potential customers served so the incremental cost per customer is actually the lowest among the three alternatives. Alternative 3 has the lowest financial impact and may be implemented as customer demand increases but does not provide the benefits of additional working area, material separation, safety and reuse options a larger site can provide.

KEY RISKS & MITIGATING STRATEGY

Key risks include land and development/construction cost escalations and Alberta Environment declining Industrial Approval Application. Probability and impact in most cases are low to medium.

RESOURCES

Waste Management staff, project management and maintenance, financial services and procurement staff resources impacts are medium to high for Alternatives 1 and 2 and low or none for Alternative 3.

CONCLUSIONS AND RECOMMENDATIONS

Alternative 1 is recommended. While the construction of the NW Eco Station could be delayed, the acquisition of an operating site should be completed within the current planning period.

CHANGES TO APPROVED PROFILE

2017 Fall SCBA (CA#40): 2.5-04 To amend funding source from Waste Services Retained Earnings to Self-Liquidating Debentures for 2017-2018 to support the positive cash balance and achieve cash targets as proposed in 2018 Rate File.

CAPITAL PROFILE REPORT

PROFILE NAME: **Mayfield Eco Station (NW)**

FUNDED

PROFILE NUMBER: **15-33-2011**

PROFILE TYPE: **Standalone**

BRANCH: **Infrastructure Planning and Design**

CAPITAL BUDGET AND FUNDING SOURCES (000's)

	Prior Years	2022	2023	2024	2025	2026	2027	2028	2029	2030	Beyond 2030	Total	
APPROVED BUDGET	Approved Budget												
	Original Budget Approved	19,810	-	-	-	-	-	-	-	-	-	-	19,810
	2015 Cap Carry Forward	-	-	-	-	-	-	-	-	-	-	-	-
	2016 Cap Carry Forward	-	-	-	-	-	-	-	-	-	-	-	-
	2017 Cap Council	-1,293	-	-	-	-	-	-	-	-	-	-	-1,293
	2017 Cap Carry Forward	1,283	-	-	-	-	-	-	-	-	-	-	1,283
	2018 Cap Budget Request for Next Cycle	-13,800	777	6,075	6,925	-	-	-	-	-	-	-	-23
	2018 Cap Release to Corp Pool	-198	-	-	-	-	-	-	-	-	-	-	-198
	2019 Cap Carry Forward	-	-	-	-	-	-	-	-	-	-	-	-
	2020 Cap Carry Forward	-	-	-	-	-	-	-	-	-	-	-	-
	2021 Cap Carry Forward	1	-1	-	-	-	-	-	-	-	-	-	-
	Current Approved Budget	5,802	776	6,075	6,925	-	-	-	-	-	-	-	19,579
Approved Funding Sources													
Self-Liquidating Debentures	5,802	-	3,520	-	-	-	-	-	-	-	-	9,322	
Waste Mgt Retained Earnings	1	776	2,555	6,925	-	-	-	-	-	-	-	10,257	
Current Approved Funding Sources	5,802	776	6,075	6,925	-	-	-	-	-	-	-	19,579	

BUDGET REQUEST													
Budget Request	-	-	-	-	-	-	-	-	-	-	-	-	-

REVISED BUDGET (IF APPROVED)													
Revised Budget (if Approved)	5,802	776	6,075	6,925	-	-	-	-	-	-	-	-	19,579
Requested Funding Source													
Self-Liquidating Debentures	5,802	-	3,520	-	-	-	-	-	-	-	-	-	9,322
Waste Mgt Retained Earnings	1	776	2,555	6,925	-	-	-	-	-	-	-	-	10,257
Requested Funding Source	5,802	776	6,075	6,925	-	-	-	-	-	-	-	-	19,579

CAPITAL BUDGET BY ACTIVITY TYPE (000's)

REVISED BUDGET (IF APPROVED)	Activity Type	Prior Years	2022	2023	2024	2025	2026	2027	2028	2029	2030	Beyond 2030	Total
	Construction	-198	776	6,075	6,925	-	-	-	-	-	-	-	13,579
	Land	6,000	-	-	-	-	-	-	-	-	-	-	6,000
	Total	5,802	776	6,075	6,925	-	-	-	-	-	-	-	19,579

OPERATING IMPACT OF CAPITAL

Type of Impact:

Branch:																
	Rev	Exp	Net	FTE	Rev	Exp	Net	FTE	Rev	Exp	Net	FTE	Rev	Exp	Net	FTE
Total Operating Impact	-	-	-	-	-	-	-	-	-	-	-	-	-	-	-	-

CAPITAL PROFILE REPORT

PROFILE NAME: **THREE-STREAM COMMUNAL COLLECTION**
 PROFILE NUMBER: **23-81-2054**
 DEPARTMENT: **Utilities**
 LEAD BRANCH: **Waste Services**
 PARTNER:
 BUDGET CYCLE: **2019-2022**

FUNDED

PROFILE STAGE:	Previously Approved
PROFILE TYPE:	Standalone
LEAD MANAGER:	Denis Jubinville
PARTNER MANAGER:	
ESTIMATED START:	January, 2023
ESTIMATED COMPLETION:	December, 2043

Service Category:	Utilities	Major Initiative:
-------------------	-----------	-------------------

GROWTH	RENEWAL	PREVIOUSLY APPROVED:	29,011
100		BUDGET REQUEST:	-
		TOTAL PROFILE BUDGET:	29,011

PROFILE DESCRIPTION

This business case is in response to the June 25, 2021, Utility Committee motion which asked Administration to consider options for fully private services within a regulated utility. The business case describes the process that Administration took to respond to the motion and makes recommendations to keep the communal sector within the existing framework. The business case recommends that the changes recommended in the previous business case be implemented. Those include changes to the current waste collection program offered to residences receiving communal collection. Currently, residences on communal collection (typically condos and apartment buildings) receive garbage and recycle collection via large communal bins, with recycling being voluntary (i.e. not all properties have recycling collection). The changes recommended include mandatory three stream separation of waste for all residences receiving communal collection. The three streams are: garbage, recycling, and organics. The associated capital funds include funding for containers, vehicles and associated accessories.

To accommodate the unique needs and challenges of different properties, the implementation phase is expected to take four years and will include working with every property in Edmonton to ensure challenges such as space restrictions and resident education are taken into consideration when rolling out the program.

Edmonton's 25-year Comprehensive Waste Management Strategy (the Waste Strategy) was approved by City Council in September 2019. The Waste Strategy established a target of 90 percent waste diversion across all sectors, and calls for the implementation of mandatory three-stream source separation of waste as a critical component of making progress towards the target.

Research shows that source separation is most effective at increasing waste diversion when municipalities set clear and consistent rules across all sectors. Consistent expectations for sorting food scraps and recyclable materials at home (regardless of dwelling type), work, school and in the community help to reinforce concepts communicated through educational programs and encourage the formation of responsible waste habits.

Following the implementation of mandatory three-stream separation for residential properties that receive curbside collection (by way of the Edmonton Cart Rollout), this business case addresses the development of a mandatory three-stream source separation service for residential properties that receive communal collection.

In Scope:

- Work with all properties receiving communal collection to transition to mandatory three stream source separation.
- Introduce carts as a collection container in the communal program (currently only bins serviced with front load vehicles are used).
- Introduce volume limits and developer standards for new developments.
- Adjust frequency of collection as required.
- Updates to the Waste Services bylaw.
- Change in processing requirements related to the Edmonton Waste Management Centre.
- Capital and operating budgets to support the program changes.
- Net Present Value (NPV) analysis.
- Revenue Requirement (RR) analysis.
- Development and delivery of education and outreach programs and materials.

Out of Scope:

- All residences include in the Cart Rollout program.
- Non-residential waste programs.
- Waste Management Policy update.
- Securing any additional processing capacity needed to process the source separated waste.

PROFILE BACKGROUND

When the June 2021 business case was presented to the Utility Committee, haulers, landlords, and building owners indicated a desire for more private sector involvement in servicing the communal collection program. In response, the Utility Committee passed the following motion:

That the Business Case and cost of service study for Residential Communal Collection be referred back to Administration to provide an alternative business model for consideration, which allows for a fully privately operated service within the regulated utility model along with a robust data sharing and accountability framework to ensure that diversion targets contained within the 25 year waste strategy are met.

This business case evaluates options that could be implemented under the conditions described in the motion.

PROFILE JUSTIFICATION

The commitment to achieve 90 percent waste diversion across sectors provides an opportunity to align the communal collection program with best practices for sustainable waste management. Waste Services researched services provided in jurisdictions across North America, Europe and Australia, and engaged local stakeholders to gain insight on how best practices could be applied in Edmonton. The result is the attached business case, which recommends a mandatory three stream source separation program. The three streams are recycling, food scraps and garbage.

Currently, properties that receive communal collection can have waste collected in two streams: garbage and recycling. Containers collected via front load vehicles (referred to as front load bins) are used for both streams in the majority of cases.

It is estimated that approximately ten percent of communal collection waste was diverted from landfill in 2021. This number is representative of a gap that must be addressed to progress toward the target defined by the Waste Strategy.

Based on recent analysis of multiple municipalities, an additional 72 percent of the material that is currently collected as garbage could be diverted through a source separation program (reflecting estimates that 40 percent of garbage is food scraps, and 32 percent is recyclable). Furthermore, Edmonton's current communal collection recycling stream has a contamination rate of about 22 percent.

Communal waste collection differs from curbside waste collection in many ways including a need for more flexible servicing due to space constraints and anonymity of the users. Compared with properties receiving curbside collection, resident turnover in properties with communal collection has a higher impact to service participation and compliance, as there is a steeper learning curve for adhering to service guidelines when moving between communal collection sites than when moving between homes that receive curbside collection.

The low diversion rate and high contamination rate present an opportunity to design and implement changes to the communal collection program.

STRATEGIC ALIGNMENT

Mandatory source separation of waste is aligned with, and critical to support, the City of Edmonton's strategic goals as outlined in the original business case presented with the June 25, 2021, City Operations report CO00581.

Implementing mandatory source separation of waste for properties receiving communal collection through private services is less aligned with the goal of Climate Resilience than the same services offered through the Waste Utility, based on the compromised environmental outcomes privatization is expected to achieve.

ALTERNATIVES CONSIDERED

The options analysis used a two-stage approach. In the first stage, the detailed options were evaluated against a wide range of criteria. In the second stage, the condensed options were evaluated in terms of their risk and cost.

Alternatives considered are:

1. Full privatization
2. Privatization with City Processing
3. Privatization with City Education
4. Private Collection and Containers
5. City Managed Services (Status Quo)

Options were evaluated by a group of subject matter experts within Waste Services in a series of workshops.

As described in Section 5.4, and in support of the options analysis, Waste Services requested information from private haulers & waste processors about their current capacity and future plans. The information collected was used to inform the options analysis as much as possible. However, Administration's ability to quantitatively evaluate options involving privatization was limited due to the lack of information about private sector operators.

COST BENEFITS

Based on limited available information about potential costs for privatized services, only the Capital and Operating savings and costs for the alternatives were evaluated, including stranded costs that would need to be managed with privatization. Please refer to the "Costs" section of the business case for cost benefit analysis. Further details are provided in the business case appendices.

KEY RISKS & MITIGATING STRATEGY

A comprehensive risk register was developed to assess the risks for each viable alternative. Through analysis of risk categories relating to Collection, Processing, Container Provision, Education and Outreach, alternative 5 for City Managed Services (Status Quo) demonstrated the lowest risk. Alternative 5 avoids risks related to:

- Achieving the waste reduction and diversion targets of the Waste Strategy;
- The City's inability to effectively or affordably regulate rates, rate increases, service outcomes, and waste processing and disposal under the current limitations of the MGA; &
- Inequitable service outcomes for some multi-unit properties and residents.

Please refer to the "Risks" section of the attached business case. Further details are provided in the business case appendices.

RESOURCES

The recommended alternative requires 30 Permanent and Seasonal FTE's and 14 Temporary FTE's for the program implementation. Please refer to the "Staff and Fleet Impacts" section of the attached business case.

CONCLUSIONS AND RECOMMENDATIONS

The recommended alternative is for mandatory colocation with voluntary chute closure within the current structure of City offered services through its own personnel and its contractors. Through risk and financial analysis, the City managed services option has the highest total score, presenting the lowest risk and has an acceptable NPV. The City's current service model, which includes significant private sector participation through competitively awarded service contracts, is a strong base upon which to introduce more flexible servicing options in collaboration with the private sector, as doing so becomes feasible.

CAPITAL PROFILE REPORT

PROFILE NAME: **Three-stream Communal Collection**
 PROFILE NUMBER: **23-81-2054**
 BRANCH: **Waste Services**

FUNDED
 PROFILE TYPE: **Standalone**

CAPITAL BUDGET AND FUNDING SOURCES (000's)

APPROVED BUDGET		Prior Years	2022	2023	2024	2025	2026	2027	2028	2029	2030	Beyond 2030	Total
	Approved Budget												
	Original Budget Approved	-	-	-	-	-	-	-	-	-	-	-	-
	2022 Cap Capital Budget Adj (one-off)	-	-	7,323	1,525	1,548	-	-	101	88	4,659	13,767	29,011
	Current Approved Budget	-	-	7,323	1,525	1,548	-	-	101	88	4,659	13,767	29,011
Approved Funding Sources													
	Self-Liquidating Debentures	-	-	-	1,525	1,548	-	-	101	88	4,659	13,767	21,688
	Waste Mgt Retained Earnings	-	-	7,323	-	-	-	-	-	-	-	-	7,323
	Current Approved Funding Sources	-	-	7,323	1,525	1,548	-	-	101	88	4,659	13,767	29,011

BUDGET REQUEST		Prior Years	2022	2023	2024	2025	2026	2027	2028	2029	2030	Beyond 2030	Total
Budget Request		-	-	-	-	-	-	-	-	-	-	-	-

REVISED BUDGET (IF APPROVED)		Prior Years	2022	2023	2024	2025	2026	2027	2028	2029	2030	Beyond 2030	Total
Revised Budget (if Approved)		-	-	7,323	1,525	1,548	-	-	101	88	4,659	13,767	29,011
Requested Funding Source													
	Self-Liquidating Debentures	-	-	-	1,525	1,548	-	-	101	88	4,659	13,767	21,688
	Waste Mgt Retained Earnings	-	-	7,323	-	-	-	-	-	-	-	-	7,323
	Requested Funding Source	-	-	7,323	1,525	1,548	-	-	101	88	4,659	13,767	29,011

CAPITAL BUDGET BY ACTIVITY TYPE (000's)

REVISED BUDGET (IF APPROVED)	Activity Type	Prior Years	2022	2023	2024	2025	2026	2027	2028	2029	2030	Beyond 2030	Total
	Other Costs	-	-	7,323	1,525	1,548	-	-	101	88	4,659	13,767	29,011
	Total	-	-	7,323	1,525	1,548	-	-	101	88	4,659	13,767	29,011

OPERATING IMPACT OF CAPITAL

Type of Impact:

Branch:																
	Rev	Exp	Net	FTE	Rev	Exp	Net	FTE	Rev	Exp	Net	FTE	Rev	Exp	Net	FTE
Total Operating Impact	-	-	-	-	-	-	-	-	-	-	-	-	-	-	-	-