

Bylaw 20908

A Bylaw to amend Charter Bylaw 20001, as amended,  
The Edmonton Zoning Bylaw  
Amendment No. 110

WHEREAS Lots 34 & 35, Block 2, Plan ND; located at 9666 - Jasper Avenue NW, Boyle Street, Edmonton, Alberta, are specified on the Zoning Map as Direct Control Zone (DC1.18461); and

WHEREAS an application was made to rezone the above described property to a Direct Control Zone (DC);

NOW THEREFORE after due compliance with the relevant provisions of the Municipal Government Act RSA 2000, ch. M-26, as amended, the Municipal Council of the City of Edmonton duly assembled enacts as follows:

1. The Zoning Map, being Part 1.20 to Charter Bylaw 20001 The Edmonton Zoning Bylaw is hereby amended by rezoning the lands legally described as Lots 34 & 35, Block 2, Plan ND; located at 9666 - Jasper Avenue NW, Boyle Street, Edmonton, Alberta, which lands are shown on the sketch plan attached as Schedule "A", from Direct Control Zone (DC1.18461) to Direct Control Zone (DC).
2. The uses and regulations of the aforementioned DC Zone are annexed hereto as Schedule "B".

3. The sketch plan annexed hereto as Schedule "A" and the uses and regulations of the DC Zone shown on Schedule "B" annexed hereto are hereby incorporated into the Zoning Bylaw, being Part 4 to Charter Bylaw 20001, The Edmonton Zoning Bylaw.

READ a first time this	day of	, A. D. 2024;
READ a second time this	day of	, A. D. 2024;
READ a third time this	day of	, A. D. 2024;
SIGNED and PASSED this	day of	, A. D. 2024.

THE CITY OF EDMONTON

---

MAYOR

---

CITY CLERK

# BYLAW 20908

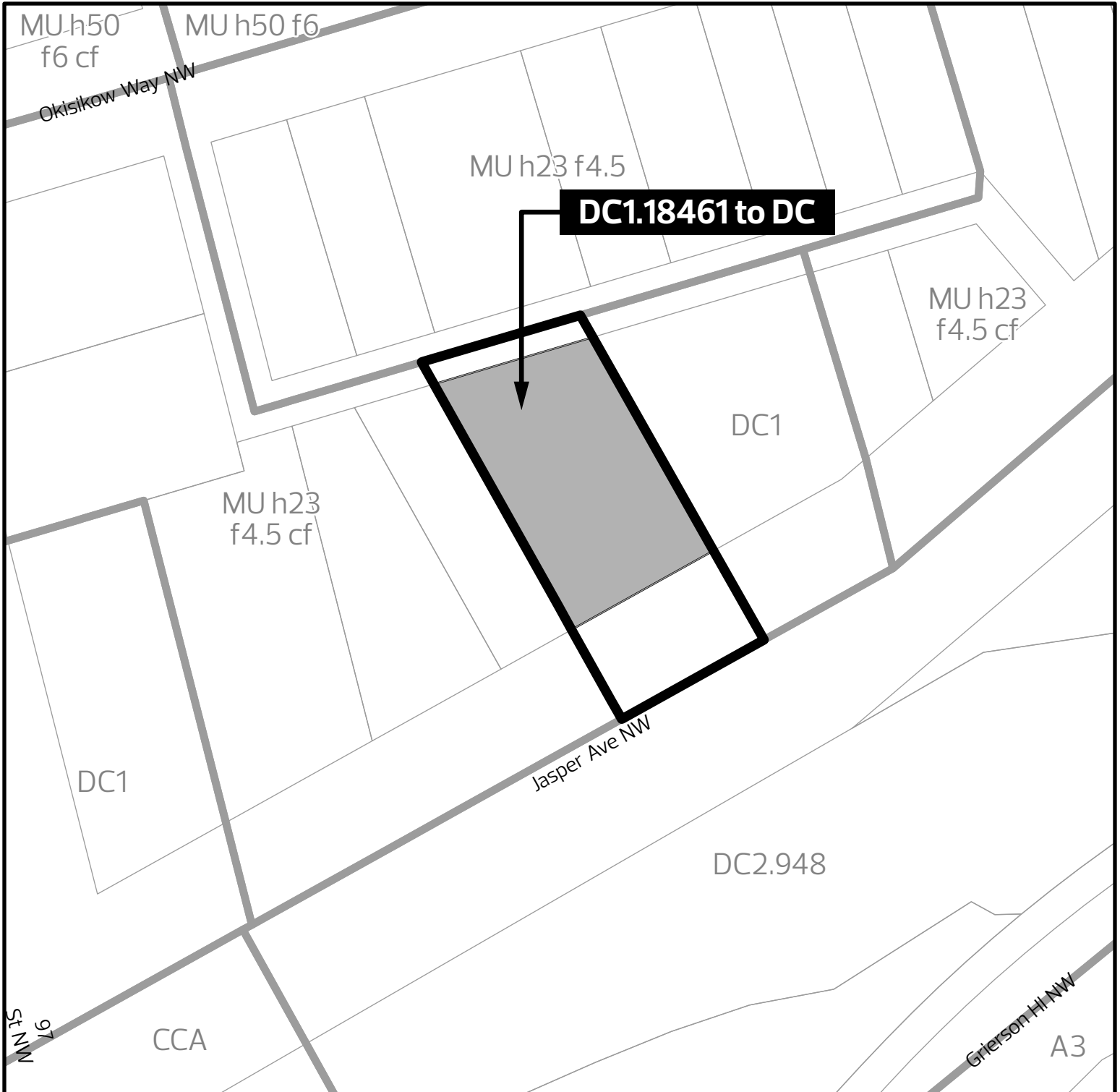

 DC1.18461 to DC



**(DC) DIRECT CONTROL ZONE****Brighton Block****1. Purpose**

- 1.1. To accommodate a mixture of uses and the continued preservation and viability of the Brighton Block, a designated Municipal Historic Resource, including a 3 Storey addition that is sympathetic to the historic character of the Brighton Block.

**2. Area of Application**

- 2.1. This Zone applies to Lots 34 and 35, Block 2, Plan ND, located on the north side of Jasper Avenue NW, east of 97 Street NW, as shown in Schedule "A" of the Bylaw adopting this Zone, Boyle Street.

**3. Uses****Residential Uses**

- 3.1. Home Based Business
- 3.2. Residential, limited to:
  - 3.2.1. Lodging Houses
  - 3.2.2. Multi-unit Housing
  - 3.2.3. Supportive Housing

**Commercial Uses**

- 3.3. Bar
- 3.4. Cannabis Retail Store
- 3.5. Custom Manufacturing
- 3.6. Food and Drink Service
- 3.7. Health Service
- 3.8. Hotel
- 3.9. Indoor Sales and Service
- 3.10. Liquor Store
- 3.11. Major Indoor Entertainment

- 3.12. Minor Indoor Entertainment
- 3.13. Office
- 3.14. Residential Sales Centre

**Community Uses**

- 3.15. Child Care Service
- 3.16. Community Service
- 3.17. Library
- 3.18. School
- 3.19. Special Event

**Agricultural Uses**

- 3.20. Urban Agriculture

**Industrial Uses**

- 3.21. Indoor Self Storage

**Sign Uses**

- 3.22. Fascia Sign
- 3.23. Projecting Sign

**4. Additional Regulations for Specific Uses**

- 4.1. Residential Uses must be located above the Ground Floor.
- 4.2. Cannabis Retail Stores must comply with Section 6.30 of the Zoning Bylaw.
- 4.3. Child Care Services must comply with Section 6.40 of the Zoning Bylaw.
- 4.4. Home Based Businesses must comply with Section 6.60 of the Zoning Bylaw.
- 4.5. Liquor Stores must comply with Section 6.70 of the Zoning Bylaw.
- 4.6. Indoor Self Storage is:
  - 4.6.1. limited to a total of 200 m<sup>2</sup> of Floor Area;
  - 4.6.2. must not have Ground Floor building Frontage; and

4.6.3. must not lead to the removal of any existing external windows or occupy space abutting any external wall of the building that has windows.

4.7. Special Events must comply with Section 6.100 of the Zoning Bylaw.

4.8. Signs must comply with Section 6.90 of the Zoning Bylaw, including Subsection 5 of Section 6.90, except:

4.8.1. A Comprehensive Sign Design Plan in accordance with Section 6.90.3 of the Zoning Bylaw is required.

4.8.2. Signs erected on the designated heritage facades and the addition must comply with the following regulations and be in general conformance with Appendices VI, VII, VIII and IX to the satisfaction of the Development Planner in consultation with the City department responsible for heritage planning:

4.8.2.1. Fascia Signs located above the third Storey of the building must be painted.

4.8.2.2. If illuminated, Signs must be lit from an external source. Backlit or internally illuminated Signs are prohibited, except where only the lettering is backlit.

4.8.2.3. No portion of a Projecting Sign may be located more than 1.0 m above the first Storey.

## **5. Site and Building Regulations**

5.1. The development must be in general conformance with the attached appendices.

5.2. The maximum Height is 24.5 m.

5.3. The maximum Floor Area Ratio is 6.0.

5.4. No Setbacks are required.

## **6. Design Regulations**

6.1. No Amenity Area is required.

6.2. All mechanical equipment, including roof mechanical units, must be concealed by screening in a manner compatible with the architectural character of the building, or otherwise concealed by incorporating it within the building, to the satisfaction of the Development Planner.

- 6.3. Residential Uses developed above ground level Non-Residential Uses must have separate access at ground level.
- 6.4. Development above the roof of the historic Brighton Block building:
  - 6.4.1. Must be visually compatible with, but distinguishable from the historic Brighton Block, to the satisfaction of the Development Planner in consultation with the City department responsible for heritage planning.
  - 6.4.2. Must have a minimum Stepback of 3.0 m from the parapet of the historic south Facade with a minimum of 60% of the south Stepback being a minimum of 5.5 m.
  - 6.4.3. No Stepback is required from the north, east and west Facades.
  - 6.4.4. Projections must not be allowed on any portion of the south Facade that is not stepped back a minimum of 5.5 m
  - 6.4.5. Projections must not extend more than 1.5 m into the Stepback.
- 6.5. Exterior lighting must be designed and finished in a manner consistent with the architectural theme of the development to accentuate architectural elements, and will be provided to ensure a well-lit environment for pedestrians, to the satisfaction of the Development Planner in consultation with the City department responsible for heritage planning.

## **7. Parking, Loading, Storage and Access Regulations**

- 7.1. No loading spaces are required.
- 7.2. A minimum of 18 Bike Parking spaces must be developed in a safe and secure location within the building.
- 7.3. Waste collection areas must be screened from view and located in the rear of the building. Waste collection areas must be designed to the satisfaction of the Development Officer, in consultation with the City department responsible for waste collection and transportation services.

## **8. Heritage Regulations**

- 8.1. The Brighton Block is a designated Municipal Historic Resources as per Bylaw 12605. Any development of the historic Brighton Block must conform with the requirements set out in Bylaw 12605, and the Standards and Guidelines for the Conservation of Historic Places in Canada, to the satisfaction of the Development Officer in consultation with the City department responsible for heritage planning.

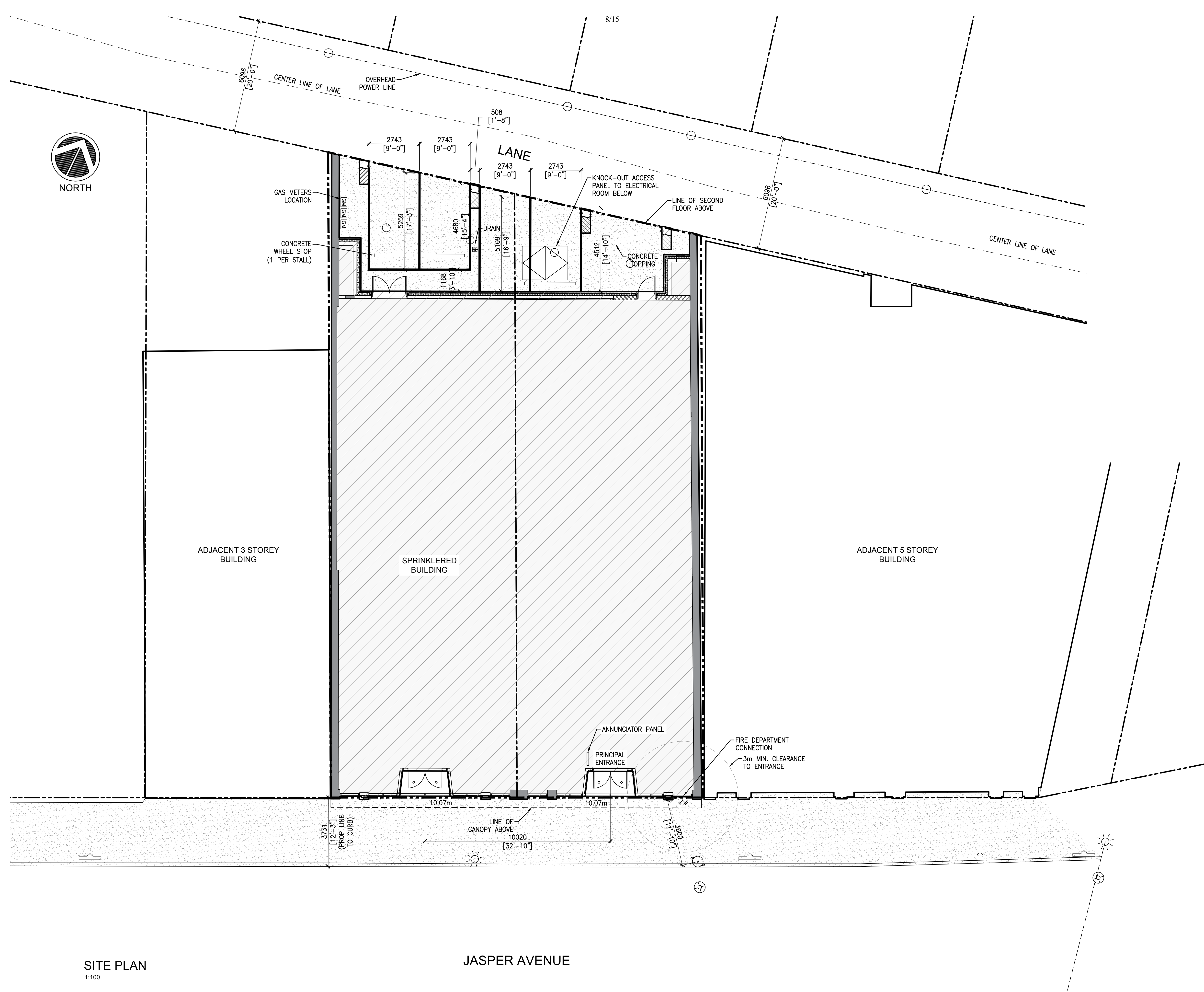

SITE PLAN  
1:100



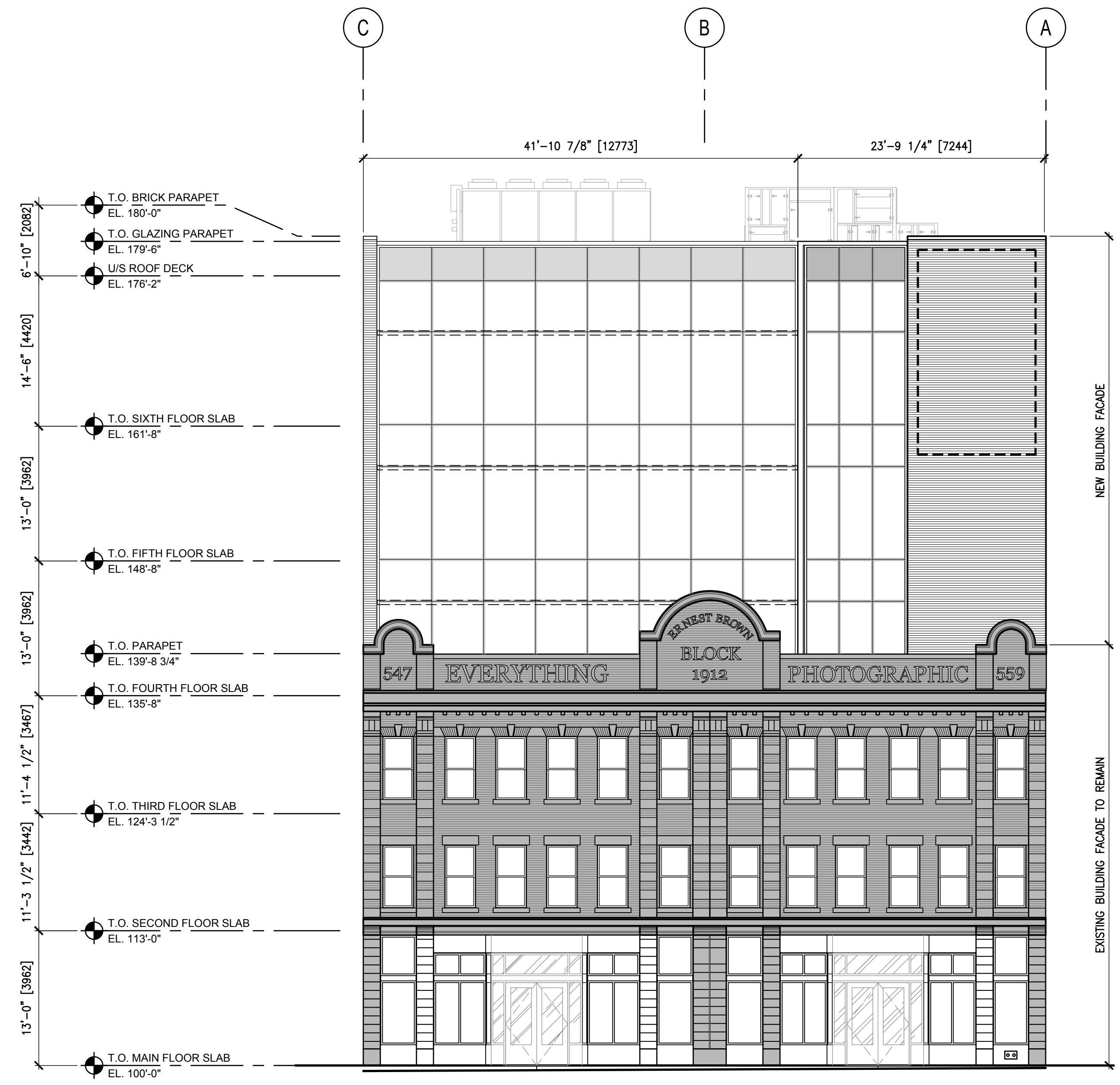

SOUTH ELEVATION  
1/8"=1'-0"



NORTH ELEVATION  
1/8"=1'-0"

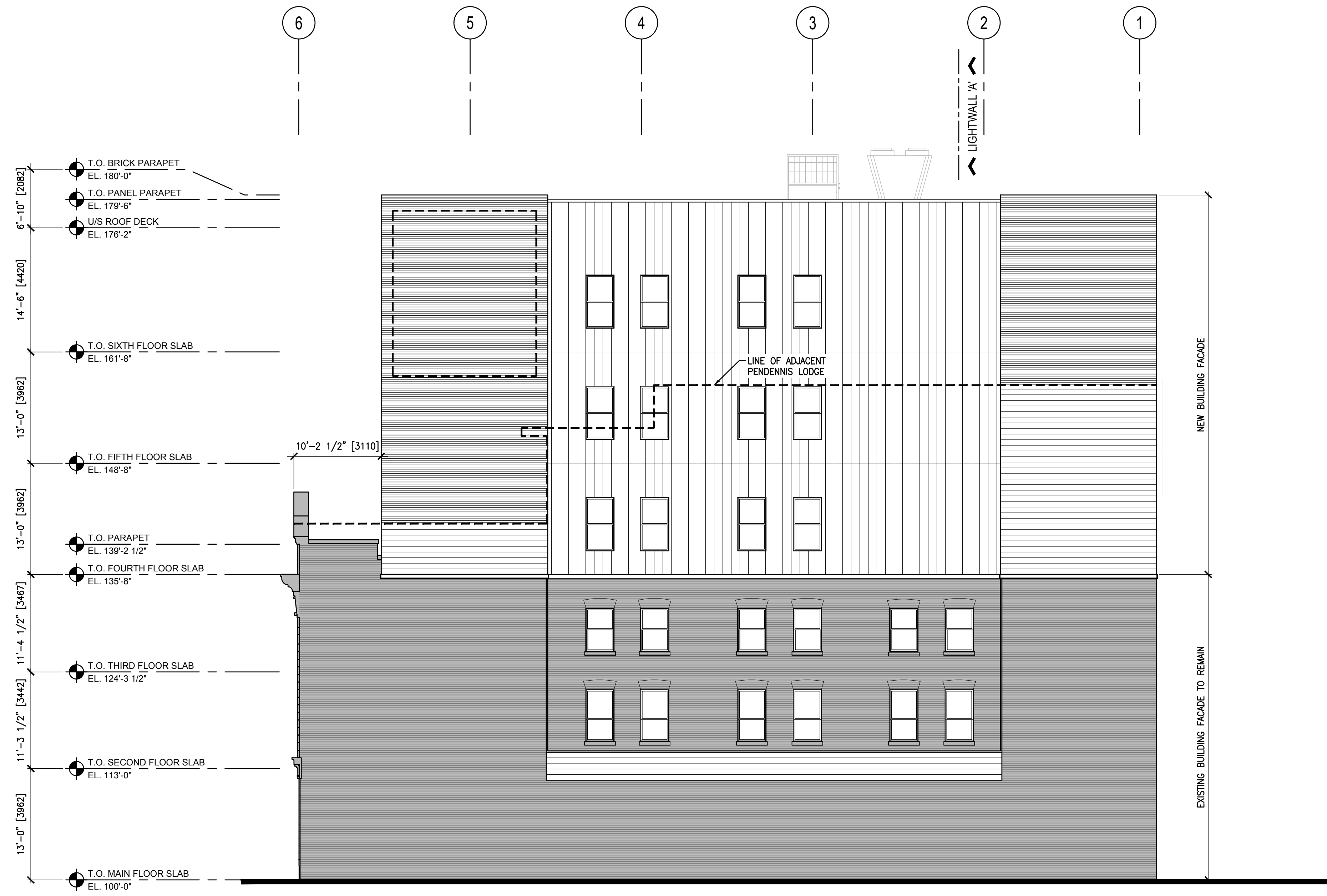

EAST ELEVATION  
1/8"=1'-0"

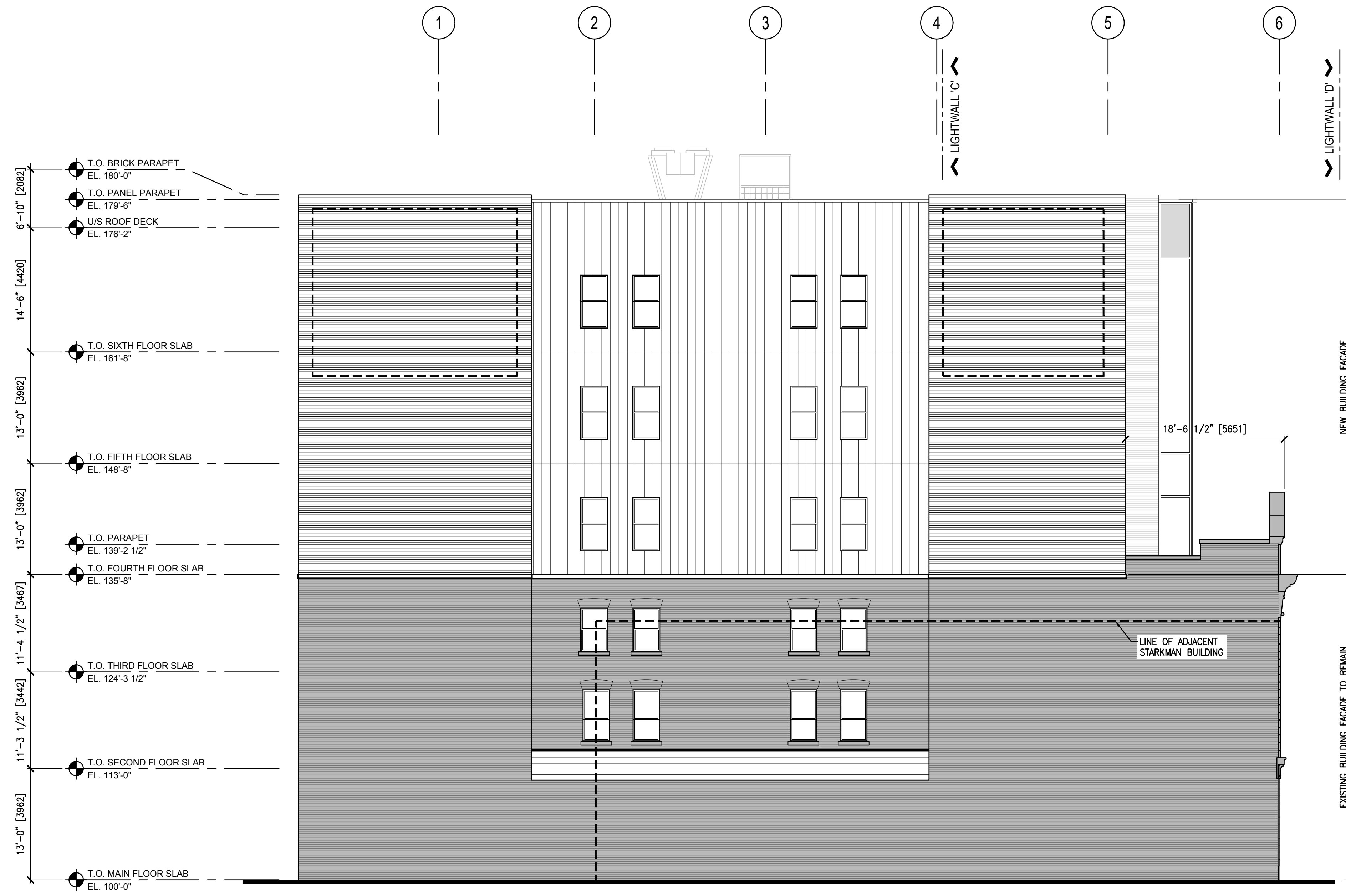

WEST ELEVATION  
1/8"=1'-0"

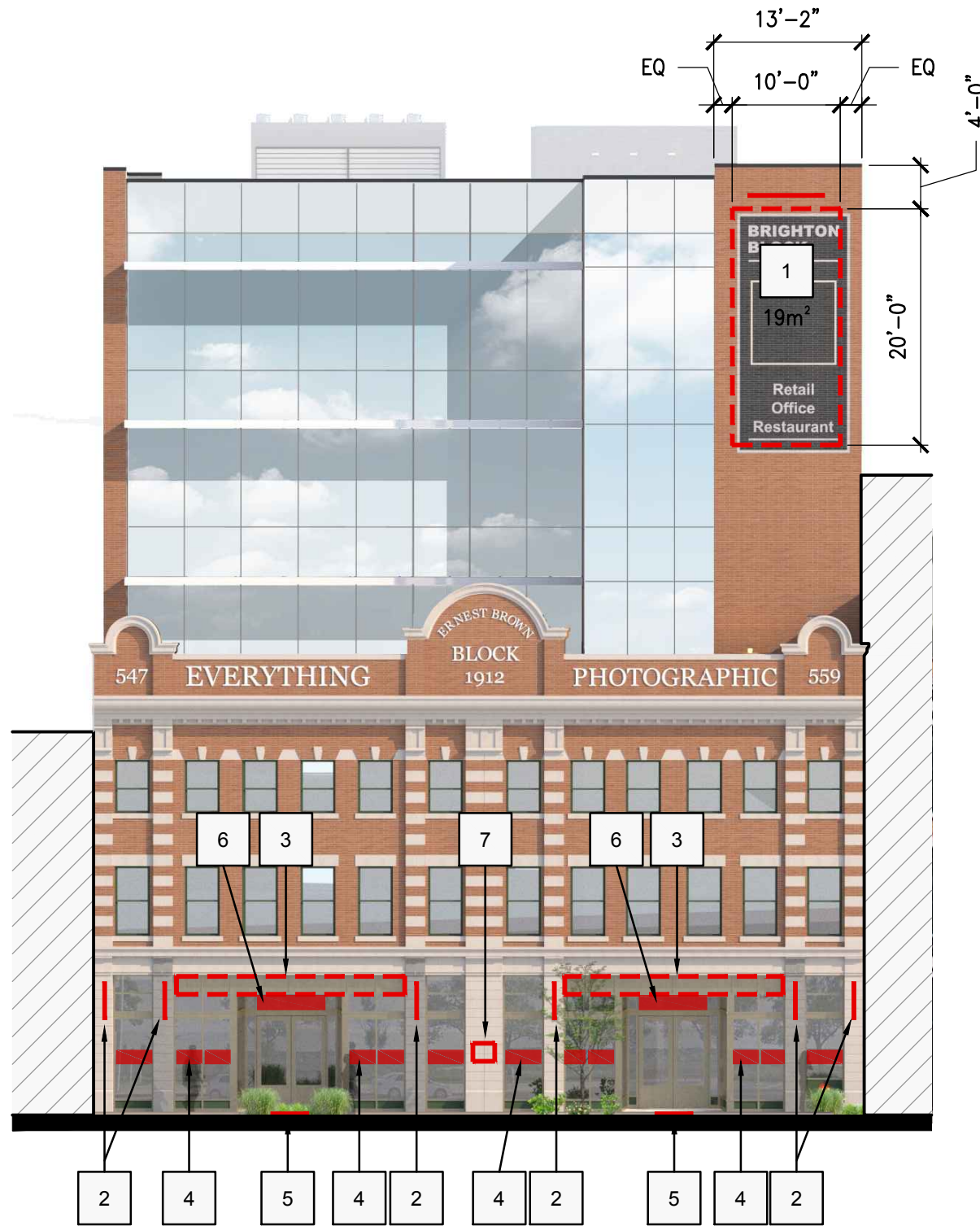

SOUTH ELEVATION

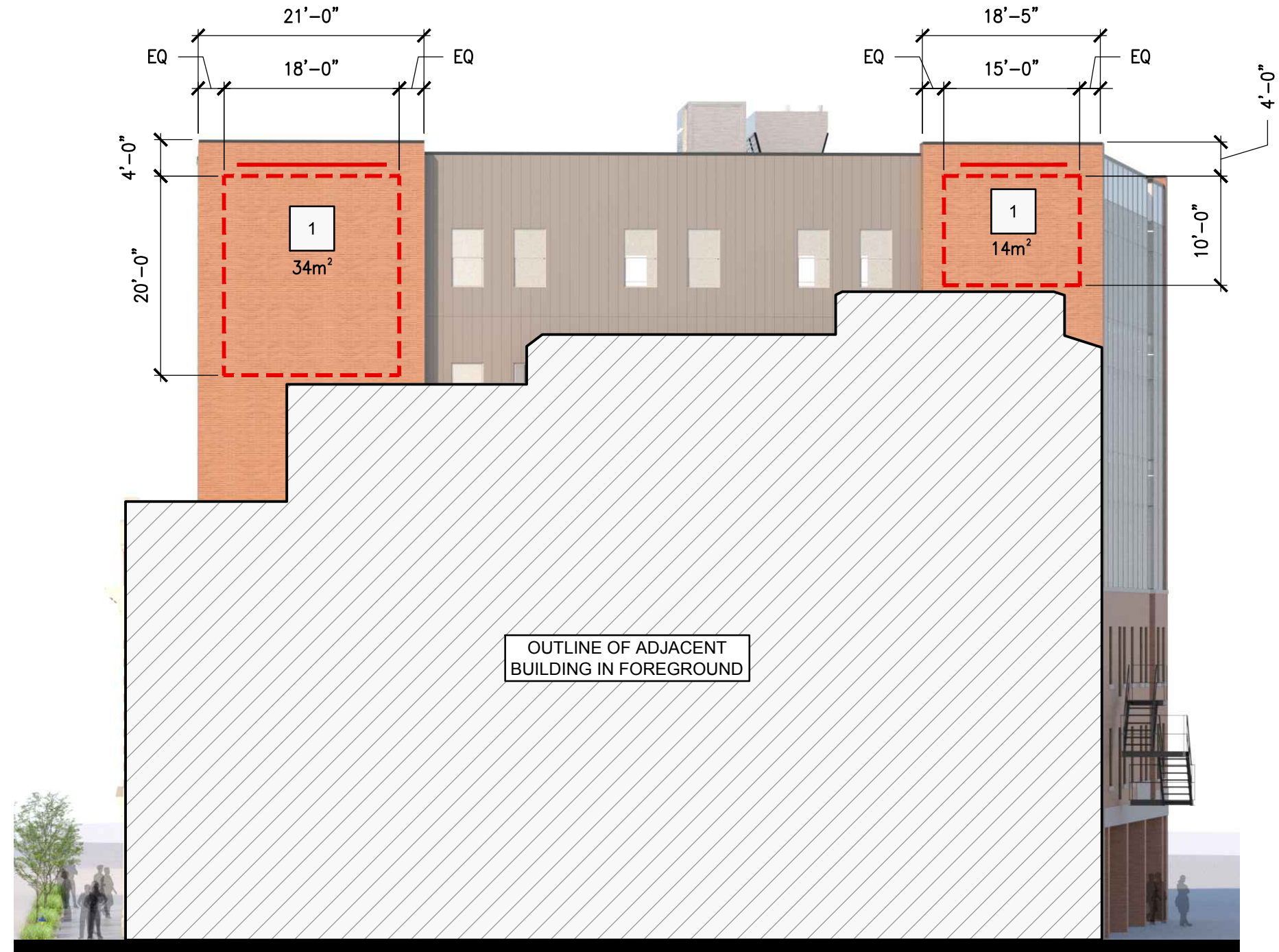

EAST ELEVATION

**SIGNAGE TYPES**

- |   |   |   |   |
|---|---|---|---|
| 1 | GHOST SIGNAGE<br>c/w LED STRIP LIGHTING ABOVE               | 5 | TILE ADDRESS SET INTO<br>ENTRANCE FLOORING      |
| 2 | PROJECTING SIGNAGE  | 6 | TRANSOM WINDOW SIGNAGE                          |
| 3 | RETRACTABLE FABRIC AWNING                                   | 7 | HERITAGE PLAQUE                                 |
| 4 | STOREFRONT WINDOW SIGNAGE<br>APPLIED TO INTERIOR OF GLAZING | 8 | GHOST OR PLAQUE STYLE<br>TENANT PARKING SIGNAGE |



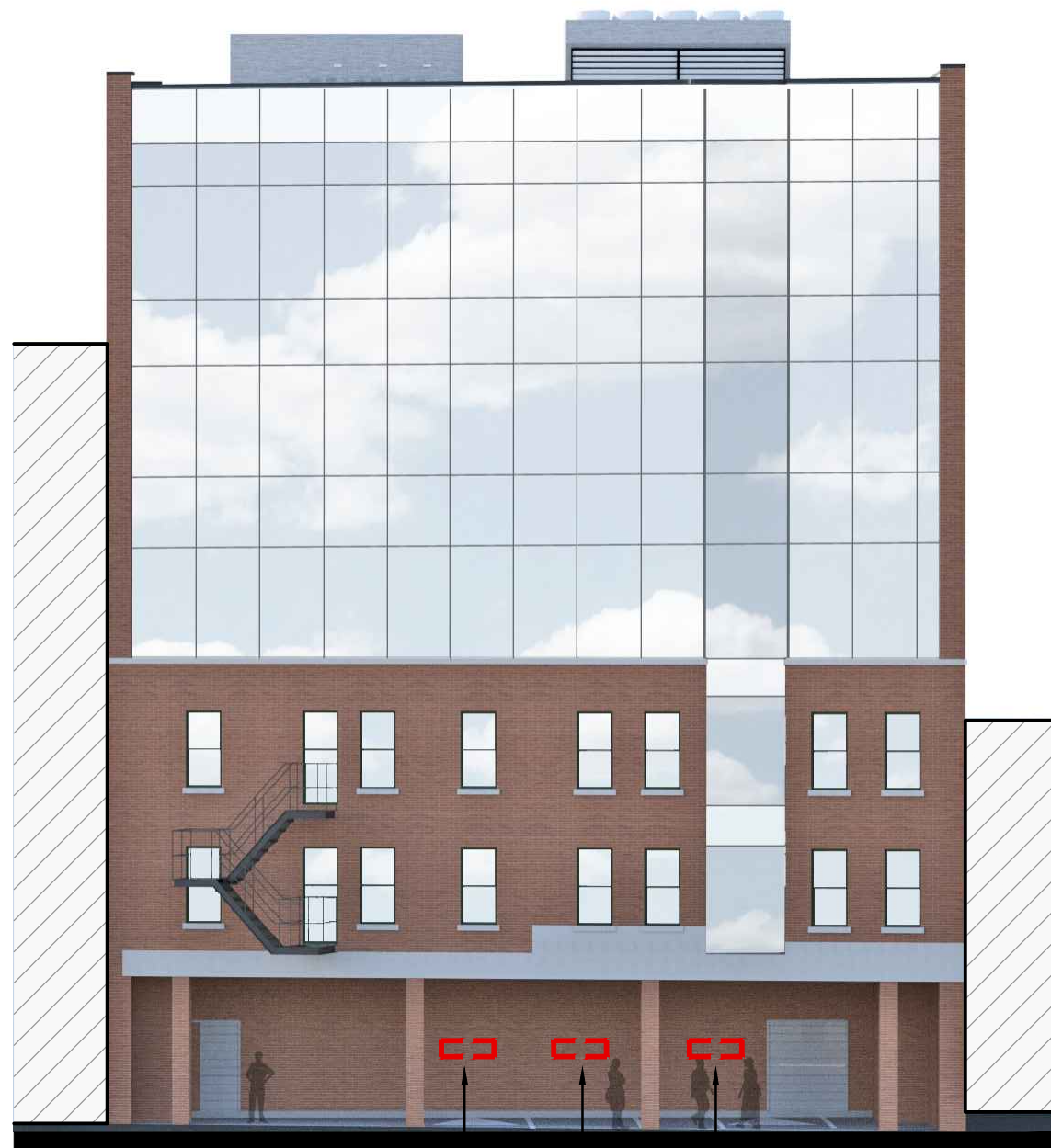

8 8 8

NORTH ELEVATION

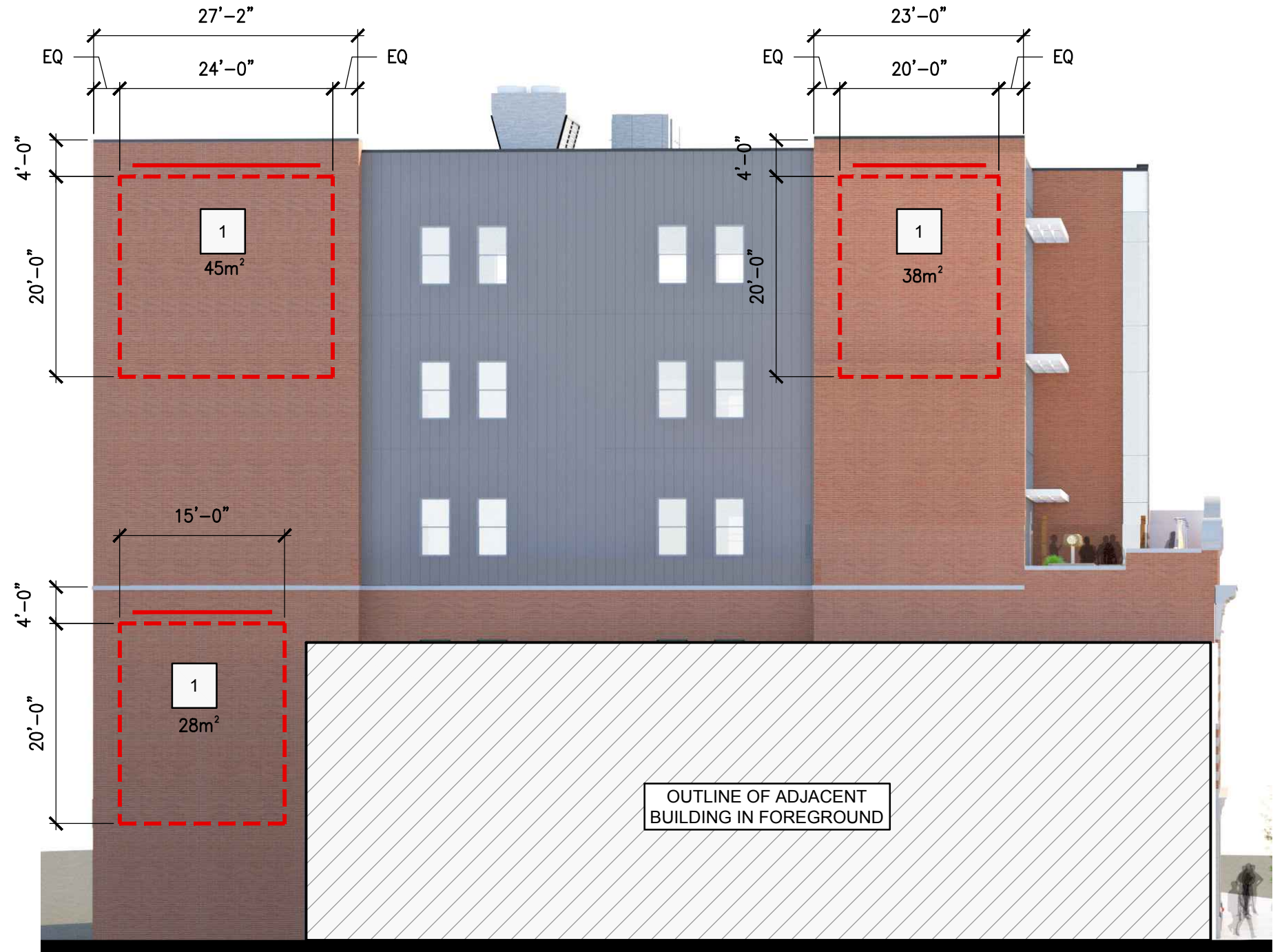

WEST ELEVATION

**SIGNAGE TYPES**

- |   |   |   |   |
|---|---|---|---|
| 1 | GHOST SIGNAGE<br>c/w LED STRIP LIGHTING ABOVE               | 5 | TILE ADDRESS SET INTO<br>ENTRANCE FLOORING      |
| 2 | PROJECTING SIGNAGE  | 6 | TRANSOM WINDOW SIGNAGE                          |
| 3 | RETRACTABLE FABRIC AWNING                                   | 7 | HERITAGE PLAQUE                                 |
| 4 | STOREFRONT WINDOW SIGNAGE<br>APPLIED TO INTERIOR OF GLAZING | 8 | GHOST OR PLAQUE STYLE<br>TENANT PARKING SIGNAGE |

# RETRACTABLE AWNINGS

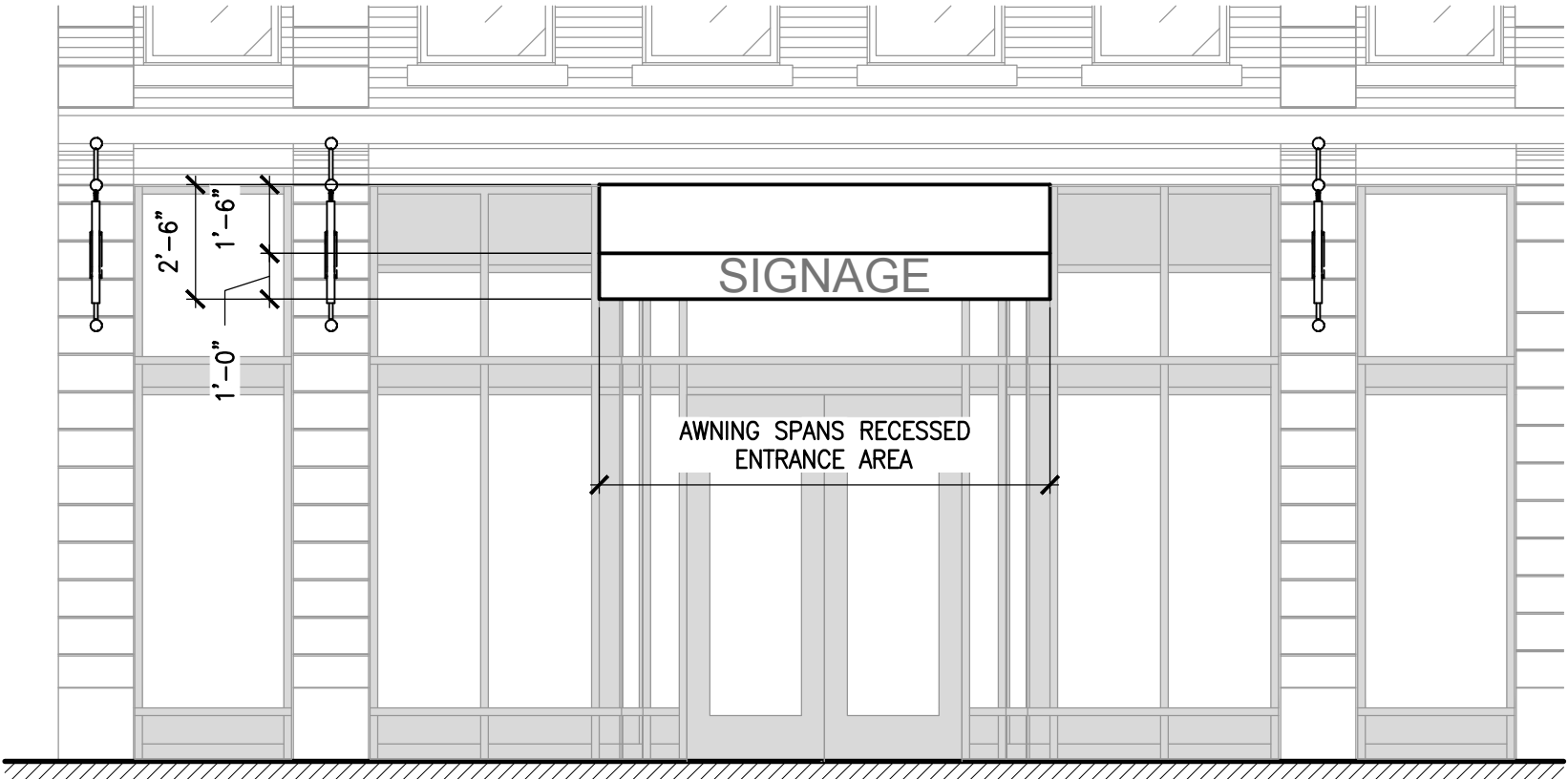

ELEVATION - OPTION 1

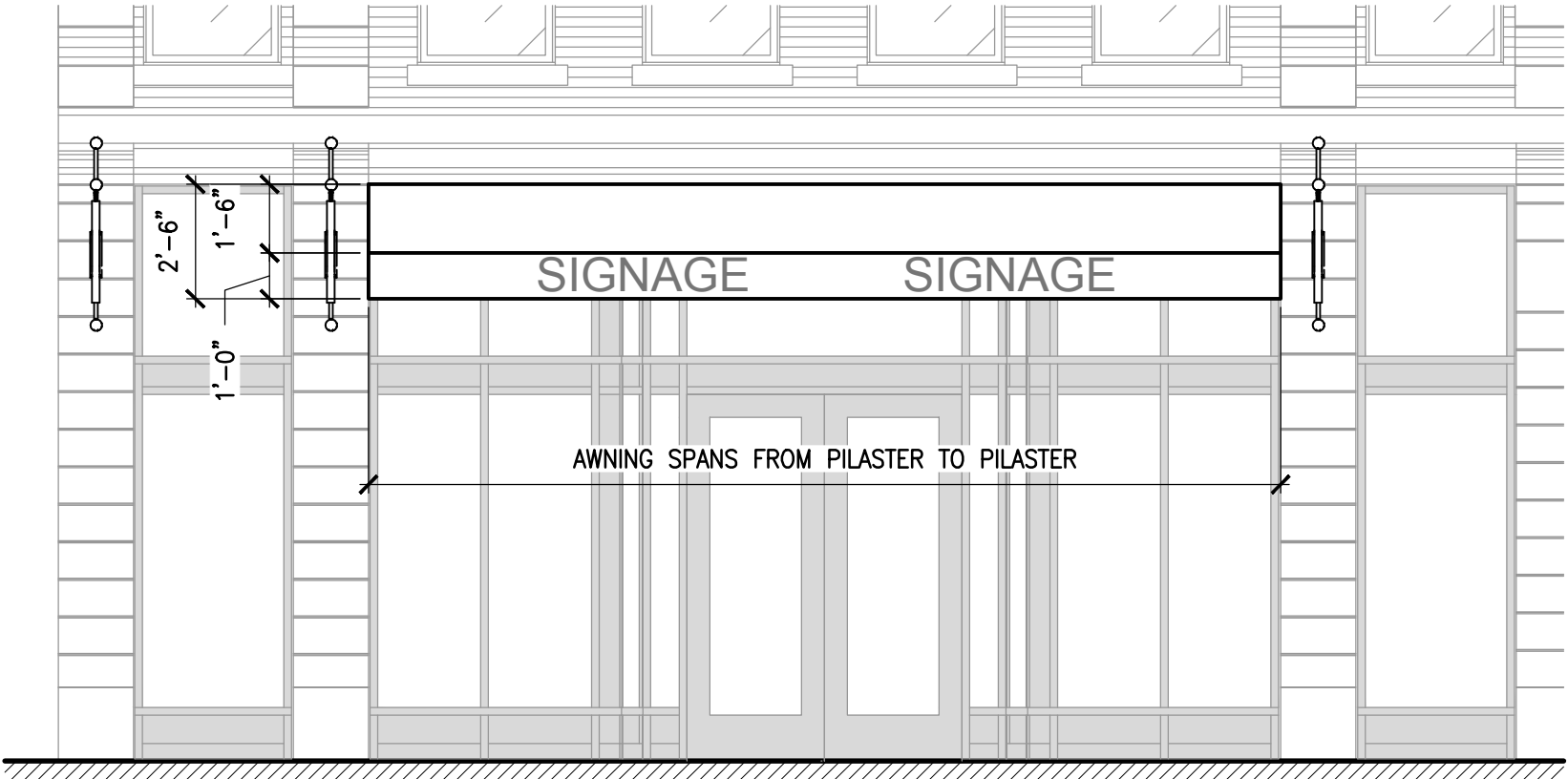

ELEVATION - OPTION 2

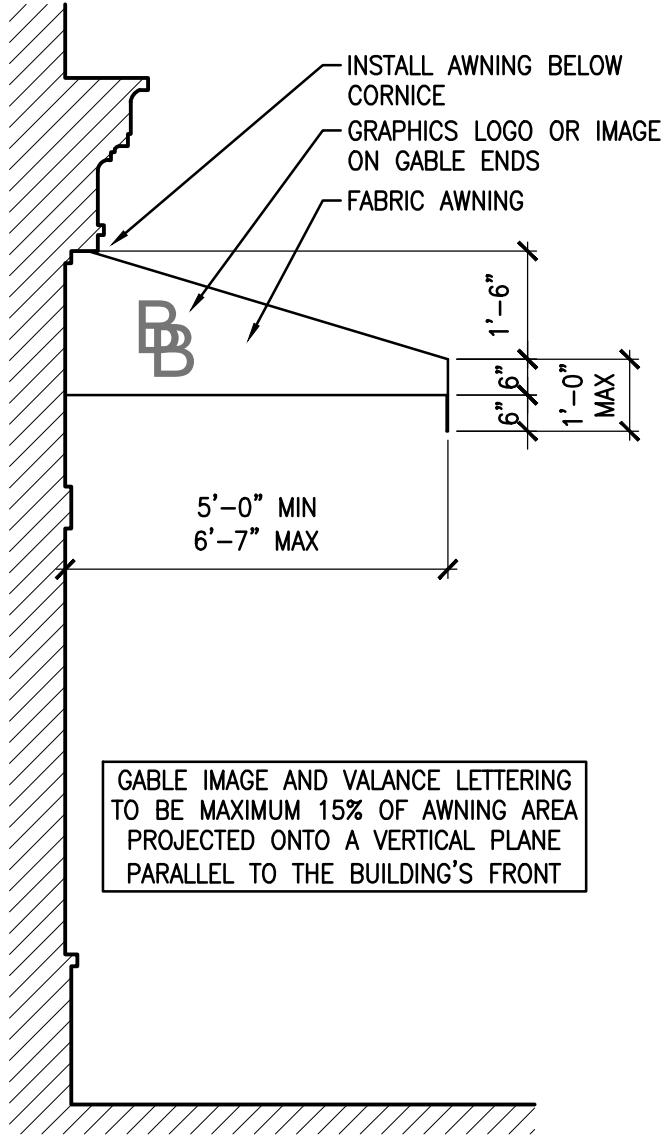

RETRACTABLE AWNING SIDE ELEVATION

GABLE IMAGE AND VALANCE LETTERING TO BE MAXIMUM 15% OF AWNING AREA PROJECTED ONTO A VERTICAL PLANE PARALLEL TO THE BUILDING'S FRONT

# PROJECTING SIGNAGE

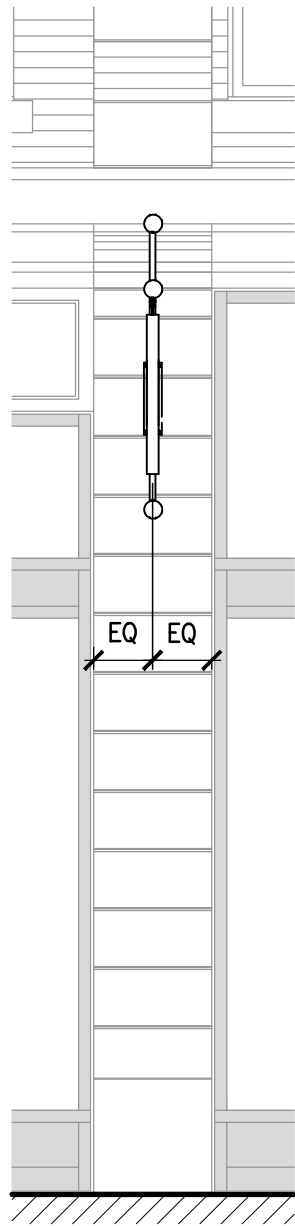

ELEVATION

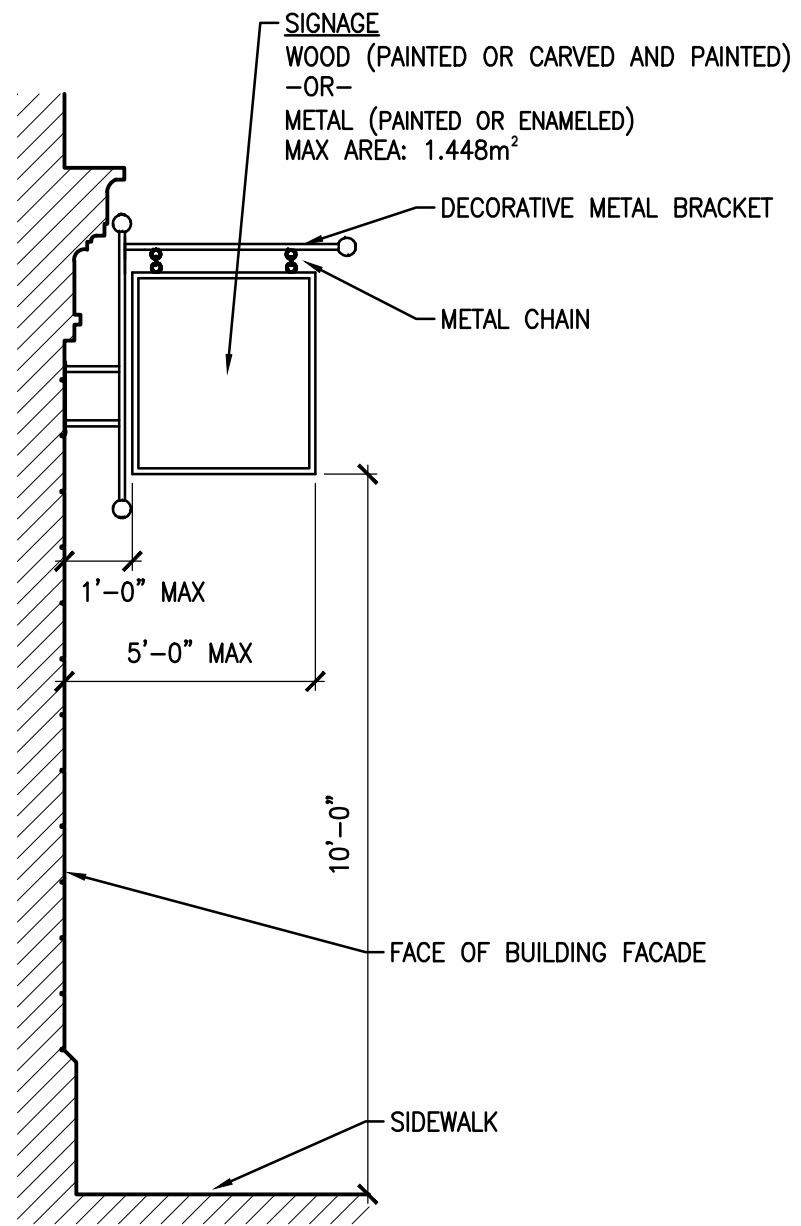

SIDE ELEVATION

SIGNAGE  
WOOD (PAINTED OR CARVED AND PAINTED)  
-OR-  
METAL (PAINTED OR ENAMELED)  
MAX AREA: 1.448m<sup>2</sup>

DECORATIVE METAL BRACKET

METAL CHAIN

1'-0" MAX

5'-0" MAX

10'-0"

FACE OF BUILDING FACADE

SIDEWALK

# WINDOW SIGNAGE

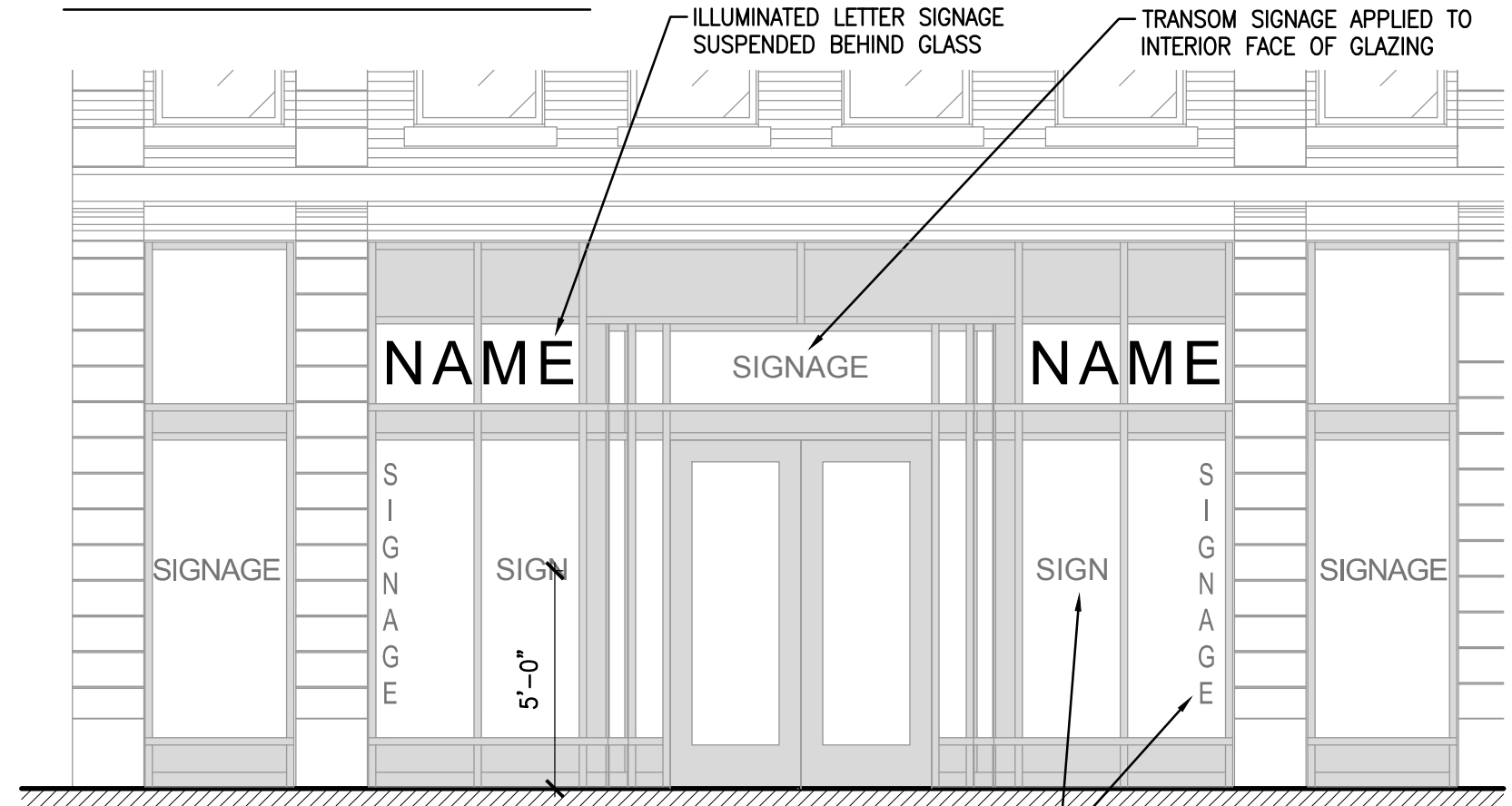

ELEVATION

SIGNAGE APPLIED TO INTERIOR FACE OF GLAZING VERTICALLY OR HORIZONTALLY. SIGNAGE TO FIT WITHIN A RECTANGLE OCCUPYING MAX 30% OF TOTAL WINDOW AREA.

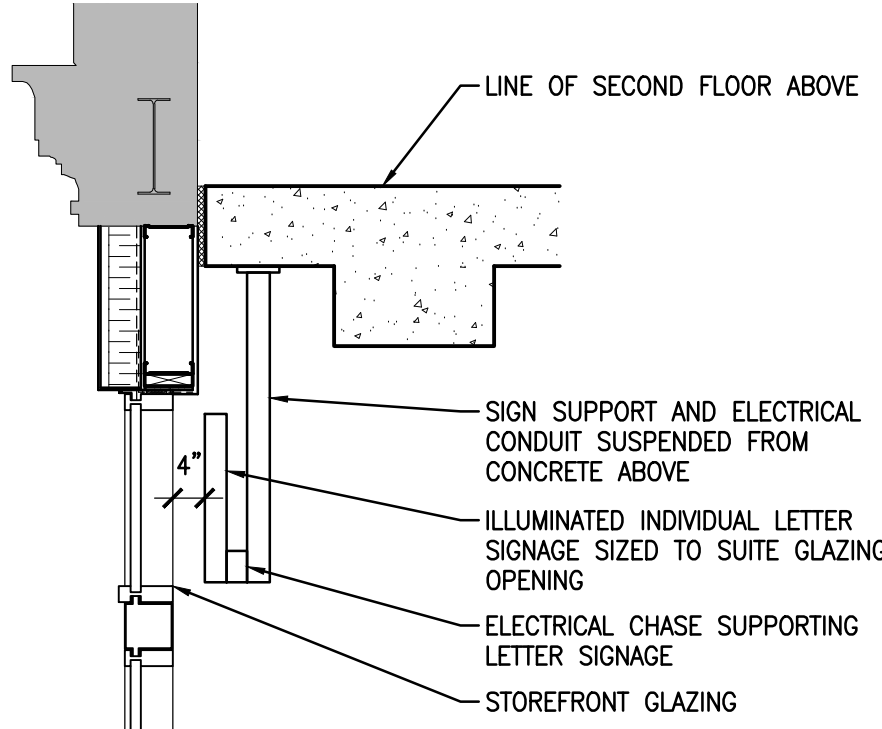

LETTER SIGNAGE SECTION

LINE OF SECOND FLOOR ABOVE

SIGN SUPPORT AND ELECTRICAL CONDUIT SUSPENDED FROM CONCRETE ABOVE

ILLUMINATED INDIVIDUAL LETTER SIGNAGE SIZED TO SUITE GLAZING OPENING

ELECTRICAL CHASE SUPPORTING LETTER SIGNAGE

STOREFRONT GLAZING

4"

WINDOW SIGNAGE TO BE LIMITED TO TENANT NAME/TYPE OF BUSINESS ONLY. ILLUMINATED SIGNAGE TO BE NON-FLASHING. FLUORESCENT OR COLOURED LIGHTING NOT TO BE USED.

ILLUMINATED LETTER SIGNAGE SUSPENDED BEHIND GLASS

TRANSOM SIGNAGE APPLIED TO INTERIOR FACE OF GLAZING

NAME

SIGNAGE

NAME

SIGNAGE

SIGNAGE

SIGN

5'-0"

SIGN

SIGNAGE

SIGNAGE