



Date: May 17, 2024 **File:** 2020-3858
To: Achyut Adhikari **Page:** Page 1 of 183
From: Erica Graham, M.Sc., P.Biol.
Project: Wellington Bridge Replacement
Subject: Environmental Impact Assessment: Update

1 INTRODUCTION

1.1 Project Background

Wellington Bridge is a three-span concrete arch bridge that carries traffic along 102 Avenue over Ramsey Ravine in Edmonton, AB. The bridge was constructed in 1932; it is now in poor condition and has reached the end of its service life. Since 2014, the bridge has been supported by a temporary shoring system to maintain vehicular traffic until the bridge is replaced. In 2020, the City of Edmonton (the City) retained Associated Engineering Alberta Ltd. (Associated) to undertake the preliminary design, detailed design, and construction services to replace Wellington Bridge, including a shared-use path.

Ramsey Ravine is part of the North Saskatchewan River valley and is within the North Saskatchewan River Valley Area Redevelopment Plan (ARP), Bylaw 7188.¹ In September 2021, Associated prepared an Environmental Impact Assessment (EIA) report following the Terms of Reference for the North Saskatchewan ARP – A Guide to Completing Environmental Impact Assessments.² The City’s Planning and Environment Services branch issued a sign-off letter (reference no. 407852315-001) pertaining to the EIA report on December 1, 2021. The EIA report and sign-off letter are included in [Appendix A](#).

The EIA report was based on a preliminary design finalized in May 2021, which included three replacement options: a single-span steel girder bridge, a three-span haunched concrete bridge, and a modern concrete arch bridge. All three options were anticipated to require a similar footprint for construction and operation. After the EIA was signed off and the detailed design for the modern concrete arch bridge was initiated, the project was suspended by the City in February 2022. In November 2023, the City notified Associated of their intent to restart the project, and the project was restarted in January 2024. The preliminary design was updated in April 2024 to include changes to the bridge and landscape architectural components, changes to the design to comply with changes in codes and standards since the project was suspended, and updates to the geotechnical information.

This memo serves as an addendum to the approved EIA report; it reflects the following specific updates to the EIA report:

- Project components that changed with updates to the preliminary design; and
- Changes to environmental regulatory requirements that occurred while the project was suspended.

This memo is intended to be read in conjunction with corresponding sections in the EIA report in [Appendix A](#).

¹ City of Edmonton. 2018. North Saskatchewan River Valley Area Redevelopment Plan, Bylaw 7188.

² City of Edmonton. 2020. Terms of Reference for the North Saskatchewan ARP – A Guide to Completing Environmental Impact Assessments.

Memo To: Achyut Adhikari

May 17, 2024

- 2 -

1.2 The Property

Wellington Bridge crosses over Ramsey Ravine on 102 Avenue NW between Wellington Crescent NW and Churchill Crescent NW, on lands owned by the City. During the preliminary design update, an updated project construction footprint was developed, with additional temporary workspaces for the demolition of the existing bridge and construction of the new bridge. The project area remains confined to SE 01-053-25 W4M, and an updated Project Overview and Zoning figure can be found in [Appendix B, Figure 1](#). Section 4 of this memo details how the project area was selected.

Zoning categories have changed since the EIA report was issued; however, boundaries have remained the same ([Appendix B, Figure 1](#)). Zoning in the project area is Small Scale Residential, Neighbourhood Parks and Services, and River Valley. The project area still in the North Saskatchewan River Valley and Ravine System overlay, with administration under Bylaw 7188.

An updated search of the Environmental Site Assessment Repository shows no records of contamination near Wellington Bridge.³ The EIA report indicated that given the age of Wellington Bridge, hazardous materials may need to be managed during removal, such as lead paint or asbestos. The report also recommended a hazardous building materials assessment be completed before the tender phase of the project. Hazardous building materials testing was conducted by Thurber Engineering Ltd. (Thurber) in April 2024, and no hazardous materials were identified ([Appendix C](#)).

Updated details on the regulatory context of the project are provided in Section 5 of this memo.

2 ENVIRONMENTAL ASSESSMENT METHODS

2.1 Desktop Assessments

Associated reviewed the publicly available data and information that were used to identify the baseline environment and potential environmental constraints in the project area for the EIA report for any updates to the data. The information was reassessed for additional potential environmental constraints in the additional temporary workspaces. Sources of information that were reviewed included:

- AbaData (Agricultural Regions of Alberta Soil Inventory soil data, historical resource values, Alberta Biodiversity Monitoring Institute wetland inventory, and wildlife areas);⁴
- Alberta Conservation Information Management System database;⁵
- Environmental Sensitivity – Score Map;⁶

³ Alberta Environment and Protected Areas. 2023. Environmental Site Assessment Repository. Available online: <https://www.esar.alberta.ca/ESARmain.aspx>. Accessed March 12, 2024.

⁴ AbaData. 2023. Available online: <https://abadata.ca/abadata3>. Accessed March 12, 2024.

⁵ Alberta Parks. 2022. Alberta Conservation Information Management System (ACIMS). Available online: <https://www.albertaparks.ca/albertaparksca/management-land-use/alberta-conservation-information-management-system-acims/>. Accessed March 12, 2024.

⁶ City of Edmonton. 2022. Environmental Sensitivity – Score Map. Available online: <https://data.edmonton.ca/Environmental-Services/Environmental-Sensitivity-Score-map-/mrgp-3hq5>. Accessed March 12, 2024.

Memo To: Achyut Adhikari

May 17, 2024

- 3 -

- Fisheries and Wildlife Management Information System database;⁷ and
- Urban Primary Land and Vegetation Inventory.⁸

2.2 Field Assessments

Since the EIA report has been completed, Associated's Kristen Andersen, P.Biol., and Sascha Bachmann, M.Sc., P.Biol., completed an additional field assessment in the project area on March 19, 2024. The purpose of this assessment was to collect additional site data to be used in preparing the naturalization designs and soil bioengineering designs for restoration of:

- The temporary workspaces within the ravine;
- The channel of the unnamed watercourse after the existing culvert under the bridge is daylighted; and
- The channel on the south side of the bridge where a temporary culvert will be required if an access ramp is constructed (additional details provided in Section 4 of this memo).

The footprint for these designs is in the updated preliminary design drawings in [Appendix D](#).

3 ENVIRONMENTAL CONTEXT

3.1 Geology, Geomorphology, and Soils

There are no updates to geology, geomorphology, or soils since the EIA report. The additional project area to account for the temporary workspaces selected when the preliminary design was updated is within the areas previously mapped in the geotechnical investigation report prepared by Thurber in 2021. Thurber's report is included in the EIA report ([Appendix A](#)).

3.2 Groundwater, Surface Water, and Fish Habitat

There are no updates to groundwater, surface water, and fish habitat since the EIA report. The additional project area to account for the temporary workspaces selected when the preliminary design was updated is within the areas previously mapped in the EIA report ([Appendix A](#)). An updated surface map showing the updated project area is provided in [Appendix B, Figure 2](#). This map also shows two *Public Lands Act* Dispositions (DLO210109 and DLO210110) held by the City on parts of the unnamed watercourse south of the project area, which were issued after the EIA report.

3.3 Vegetation

There are minimal updates to the vegetation in and surrounding the project area since the EIA report. The City Trees Map⁹ has been updated since the EIA report was completed, and an updated vegetation map, including the updated project area, is provided in [Appendix B, Figure 3](#). Currently, three boulevard trees are in the project area, compared to eight previously

⁷ Government of Alberta. 2024. Fish and Wildlife Internet Mapping Tool. Available online: https://geospatial.alberta.ca/FWIMT_Pub/Viewer/?Viewer=FWIMT_Pub. Accessed March 12, 2024.

⁸ City of Edmonton. 2022. Urban Primary Land Vegetation Inventory. Available online: <https://data.edmonton.ca/Environmental-Services/Urban-Primary-Land-Vegetation-Inventory-2015/5x9p-z4dg>. Accessed March 12, 2024.

⁹ City of Edmonton. 2024. Trees Map. Available online: <https://data.edmonton.ca/Environmental-Services/Trees-Map/udbt-eiax>. Accessed May 13, 2024.

Memo To: Achyut Adhikari
 May 17, 2024

- 4 -

shown in the EIA report. Additional natural stand trees are now included in the project area due to the addition of the temporary workspaces. No new elemental occurrences from were identified in the Alberta Conservation Information Management System database during this update review, compared to those included in the EIA report.

3.4 Wildlife

The Fisheries and Wildlife Management Information System database revealed three additional terrestrial wildlife species reported within a 2 km radius of the project area. **Table 3-1** lists these species, their conservation concern and status, preferred habitat, and potential to occur in the project area. An updated wildlife map showing the updated project area is provided in **Appendix B, Figure 4**.

Table 3-1 Additional Wildlife Species Previously Recorded Within 2 km of the Project Area

Species	General Status of Alberta Wild Species	Wildlife Act	Species at Risk Act	COSEWIC Status	Preferred Habitat and Potential to Occur in Project Area
Canadian toad (<i>Anaxyrus hemiophrys</i>)	May be at risk	NA	NA	NA	<ul style="list-style-type: none"> Boreal and parkland habitats. There is moderate potential for this species to occur in the project area.
Plains garter snake (<i>Thamnophis radix</i>)	Sensitive	NA	NA	NA	<ul style="list-style-type: none"> Meadows and prairies adjacent to water sources such as ponds, streams, and marshes. There is low potential for this species to occur in the project area.
Red-sided garter snake (<i>Thamnophis sirtalis</i>)	Sensitive	NA	NA	NA	<ul style="list-style-type: none"> Near water in various habitats, including forests, fields, prairies, streams, wetlands, meadows, marshes, and ponds. There is moderate potential for this species to occur in the project area.

COSEWIC – Committee on the Status of Endangered Wildlife in Canada; NA – Not Applicable

Since the EIA report was completed, the two adult bat carcasses and the fecal matter collected from beneath Wellington Bridge were sent for genetic testing. The DNA test results confirmed that the carcasses and fecal matter were associated with the little brown bat (*Myotis lucifugus*). Additional details can be found in the bat mitigation plan prepared by Associated in April 2024 (**Appendix E**).

Memo To: Achyut Adhikari

May 17, 2024

- 5 -

3.5 Historical Resources

A review of historical resources indicated no additional historical resource listings other than those previously identified in the EIA report ([Appendix A](#)). Updated details on the *Historical Resources Act* permitting are provided in Section 5 of this memo.

4 PROJECT DETAILS

The EIA report was based on a preliminary design report finalized in May 2021, which included three replacement options: a single-span steel girder bridge, a three-span haunched concrete bridge, and a modern concrete arch bridge. All three options were anticipated to require a similar footprint for construction and operation, which were encompassed within the project area. Through the initial preliminary design, Associated recommended the modern concrete arch bridge, which the City subsequently chose to proceed with for the detailed design.

Construction is anticipated to begin two years earlier than indicated in the EIA report; the duration of construction is anticipated to be similar to the timeline indicated in the EIA report. The current estimated timeline of construction includes the following milestones:

- Contractor mobilization: August 2025
- Demolition: Begin in September 2025
- Substantial completion: October/November 2026
- Final completion: July 2027

4.1 Single-Span Steel Girder Bridge

This option was not selected, and any reference to it in the EIA report no longer applies to the project.

4.2 Three-Span Haunched Concrete Bridge

This option was not selected, and any reference to it in the EIA report no longer applies to the project.

4.3 Modern Concrete Arch Bridge

The existing road right-of-way for 102 Avenue is 30.6 m, as confirmed from the cadastral base plan. Based on the proposed out-to-out bridge width of 23.78 m, the new bridge and widened approach roads will fit within the existing right-of-way. Updated preliminary design drawings are included in [Appendix D](#). To facilitate construction access into the ravine and for general site operations, additional space will be required during construction beyond the 30 m right-of-way width. Land titles indicate that the affected properties are owned by the City. A part of the new northeast node will be located outside the existing right-of-way. Land titles indicate that the affected property is owned by the City.

In the EIA report, Associated expected that the primary laydown area will be on the closed part of 102 Avenue, immediately adjacent to the bridge, and that there may be some encroachment onto the boulevards and surrounding paths at the top of the ravine. The report also noted that some laydown of materials within the ravine should be expected during

Memo To: Achyut Adhikari

May 17, 2024

- 6 -

construction, and that due to the size of the existing bridge, relatively large demolition equipment will likely require access to the ravine.

As noted in the preliminary design update, the area available for the contractor laydown is constrained by Wellington Crescent east of the existing bridge and Churchill Crescent to the west. There is City-owned property on the southwest corner which could also be used to provide additional space for the contractor laydown. Temporary traffic accommodation measures could be used to further increase the available laydown area to the alley east of the bridge and 132 Street to the west.

The ravine can be accessed only by the pedestrian pathway, which has entry points from Churchill Crescent, located 150 m to the north, and from Government House Park, located 800 m to the southeast. However, accessing the site via the pedestrian pathway is undesirable due to sections of steep grade, narrow pathway width, and tight clearances to the natural vegetation on either side. Using the pedestrian pathway would require clearing along its length and may still prove challenging for some construction equipment. To limit the extents of clearing and ensure accessibility for all construction equipment, access is planned from the top of the ravine, on 102 Avenue.

In developing a bridge demolition footprint, we have assumed that the selected contractor will construct an access ramp on the south side of the bridge. The ramp could be constructed to provide access from either the east headslope or the west headslope. Temporary fill will be required in the ravine to provide safe access to a working platform below the bridge so that equipment can operate safely off the bridge during demolition. Before placing temporary fill, a temporary culvert would be installed with the unnamed watercourse. The footprint in the updated preliminary design drawings ([Appendix D](#)) is based on a 10 m wide access ramp to provide sufficient room for trucking and demolition equipment, and to allow a safe setback clearance during demolition operations.

We have accounted for the temporary excavation that will be required to construct the new bridge elements and gravel wedge extensions for the headslopes. We have assumed temporary excavations will be completed at a 1:1 slope starting at the base of excavations. A 3 m buffer has been provided along all footprint boundaries for bridge construction to allow for shallower temporary cut and fill slopes, which may be required for construction access or due to unexpected soil conditions. In areas where only roadway construction will occur, the footprint has been based on the construction area and the expected landscaping tie-ins along the construction boundaries.

The last item considered in determining the construction footprint was the formwork and falsework required for the concrete elements, including the abutment backwall and wingwalls, arches, and bridge deck. The construction footprint accounts for access walkways on both sides of the new bridge to allow for concrete deck placement, concrete deck finishing, exterior concrete finishing, installation of pedestrian railing, and installation of lighting fixtures.

5 REGULATORY FRAMEWORK

The completed and in-progress permitting required for the project were summarized in [Table 5-1](#) of the EIA report ([Appendix A](#)). The EIA report noted that these regulatory requirements should be revisited throughout the project planning



Memo To: Achyut Adhikari
May 17, 2024
- 7 -

and detailed design because they are subject to change. Additional regulatory permitting required due to project and regulatory changes is provided in **Table 3-2**.

Table 3-2 Additional Anticipated Environmental Permitting Required for the Project

Legislation	Approval Type	Trigger	Notes on Requirements	Estimated Agency Review Timeline
Municipal				
City of Edmonton Bylaw 18825 (Public Tree Bylaw)	Public Tree Permit	Work within 5 m of the trunk of any boulevard or open-space tree, or within 10 m of any boundary of a natural stand Bylaw came into force on May 1, 2022	Submission of a Tree Preservation Plan and/or Tree Protection Plan to the City. A Tree Protection Plan is required for vehicular access, laydown, demolition, or construction activities that do not involve below-ground work, and a Tree Preservation Plan is required for work that requires excavation or grade changes.	2 weeks
Provincial				
<i>Historical Resources Act</i>	Approval	Ground disturbance on lands with a historical resource listing value, or demolition of a historical structure	A <i>Historical Resources Act</i> approval (HRA number: 4715-20-0061-003) was issued for the project area on April 13, 2021. An amendment to this approval will be required for ground disturbance in the additional project area identified during the preliminary design update.	1-2 months
<i>Water Act</i>	Notification	Installation of a temporary crossing in the unnamed	Notification requires written specifications and	2 weeks (notification)

Memo To: Achyut Adhikari
May 17, 2024
- 8 -

Legislation	Approval Type	Trigger	Notes on Requirements	Estimated Agency Review Timeline
Code of Practice for Watercourse Crossings		watercourse in the temporary workspace on the south side of the right-of-way during construction; Type 3 crossing is anticipated	recommendations prepared by a Qualified Aquatic Environmental Specialist if a Type 3 crossing is installed and isolation is required during installation because the site is not dry.	period before construction begins)
<i>Wildlife Act</i>	Letter of authorization	Removal of the roost used by little brown bat, a listed species, through placing exclusion measures and demolishing Wellington Bridge; required under Section 36(1) of the Act	The process is not well documented. Associated has been communicating with the provincial bat specialist regarding the letter of authorization. Submission of the bat mitigation plan is anticipated to support the application.	1-2 weeks

Trees in the project area may need to be removed ([Appendix D](#)). Associated will confirm which trees will be affected during detailed design, in consultation with the City’s Urban Forester and Natural Area Operations team.

6 PROJECT IMPACTS AND MITIGATION MEASURES

6.1 Environmental Impacts

The EIA report ([Appendix A](#)) details potential environmental impacts in terms of geology, geomorphology, soils, groundwater, surface water, fish habitat, vegetation, wildlife, and historical resources. The potential impacts remain the same as those described in the EIA report. Potential impacts to vegetation and to wildlife, such as nesting birds, are anticipated to have a greater local spatial extents and higher likelihood because clearing for the temporary workspaces will result in an increased project area. However, the spatial extents of impacts will remain local to the project area.

6.2 Cumulative Impacts

Minimal cumulative impacts are still anticipated as part of the project. The project is still expected to have some localized positive impacts on the slope stability and erosion issues in the project area, resulting from the slope naturalization and bioengineering designs that will be completed during detailed design.

Memo To: Achyut Adhikari

May 17, 2024

- 9 -

6.3 Mitigation Measures

The mitigation measures detailed in the EIA report ([Appendix A](#)) still apply to the project. Additional mitigation measures to reduce impacts to the maternal bat roosting colony have been developed and are included in the bat mitigation plan in [Appendix E](#). Additional mitigation measures and design considerations to reduce impacts are described below.

During the initial preliminary design, a highly landscaped design was planned; however, this was reassessed during the preliminary design update, and a more naturalized approach is now planned for restoring the temporary workspaces after construction. Beneath the new bridge, the headslopes will be covered with riprap. Beside the new headslopes, revegetation is planned, with plant species appropriate to the ravine and restoration techniques to support this success. The disturbed slopes are planned to be restored as follows:

- Where forest existed before construction, rough and loose soil configuration will be applied to slopes 2:1 or flatter to:
 - Reduce surface water runoff and prevent erosion by eliminating soil compaction and improving infiltration.
 - Create conditions ideal for tree growth and establish microsites to promote species diversity.
- Coarse woody debris will be spread, using material salvaged during tree clearing at the site. Coarse woody debris provides wildlife habitat, promotes soil health, creates microsites for plants, mosses, and lichens, creates structural diversity on the forest floor, and contributes to erosion control.
- Native trees and shrubs will be planted to reestablish vegetation naturally found on the ravine slopes and minimize establishment of weeds.
- Where slope is steeper than 2:1 and rough and loose soil configuration cannot be created by the excavator, alternative soil bioengineering treatments will be used to control erosion and establish native woody vegetation, including modified brush layers.
- Topsoil will be salvaged and stockpiled for replacement during slope restoration to ensure soils used in restoration contain native propagules and that the soil biology is appropriate to forest restoration.

The existing culvert will be removed, and the open channel in the unnamed watercourse beneath the bridge will be reinstated; the details will be finalized during the detailed design phase of the project. The watercourse is planned to be daylighted and restored as follows:

- The section of watercourse that currently flows through a culvert will be daylighted, and the natural channel will be established.
- Dense live willow staking will be installed starting at the low-water mark to the top of bank in a 1 m band along each side of the channel. Reduced-density willow staking will be installed along the banks above the high-water mark in a 1 to 2 m wide band. Willow staking prevents toe erosion and undercutting of banks. The underground part of the stem grows roots that bind the soil, and the aboveground portion decreases water velocity to reduce erosion and foster sediment deposition.

The temporary culvert and fill will be removed, and the open channel will be reinstated. This part of the channel currently shows signs of erosion, including failed riprap and exposed geotextile. Restoration is planned to stabilize the channel as follows:



Memo To: Achyut Adhikari

May 17, 2024

- 10 -

- Fill material will be removed to achieve an elevation similar to that of the adjoining daylighted watercourse.
- Riprap is anticipated to be used because of the steep channel gradient; this will be validated based on hydrotechnical data.
- Soil bioengineering with willow staking at the top of bank on both sides of the riprap will be included in design.

Mitigation measures will continue to be incorporated during design and construction. Some additional considerations identified during the preliminary design update that will minimize construction impacts include:

- The arch ribs of the modern concrete arch will be founded on large spread footings that incorporate micropiles for additional lateral resistance and capacity. This avoids needing to construct large-diameter, bored, cast-in-place piles, which would be required to have sufficient stiffness to provide the horizontal and moment resistance to support the base of the arch and the vertical loads. This approach also avoids piling risks associated with the Empress Sand Formation.
- The large foundations in the base of the ravine are the most complex aspect of the construction. The shallow structural depth and large overhang from the wingwalls reduce the footprint of the abutment and limit the loading of the existing landslide area to the northwest of the structure.
- The use of large piling equipment in the ravine is minimized by using spread footings and micropiles, reducing the construction footprint require within the ravine.
- Large cranes will not be needed due to the cast-in-place nature of the construction, reducing the construction footprint and eliminating a source of potential soil compaction.

7 ENVIRONMENTAL MONITORING

7.1 Construction

The bat mitigation plan ([Appendix E](#)) outlines additional monitoring to that described in the EIA report, including:

- Inspecting exclusion materials regularly before demolishing the bridge, especially after heavy rain, snow, or high-wind events, and repairing any damaged exclusion materials as soon as possible;
- Inspecting bat boxes for signs of vandalism or damage, and reporting any deficiencies to the site supervisor and City project manager; and
- Reporting all bat sightings to the site supervisor, City project manager, and consulting engineer project manager.

7.2 Post Construction

In addition to the monitoring outlined in the EIA report, the naturalized restoration of the temporary workspaces and the bioengineering where the unnamed watercourse will be daylighted will be inspected during the growing season for two years after construction.

Memo To: Achyut Adhikari

May 17, 2024

- 11 -

8 PUBLIC, INDIGENOUS, AND STAKEHOLDER ENGAGEMENT

8.1 Background and Engagement Approach

The Wellington Bridge Replacement webpage (www.edmonton.ca/wellingtonbridge) continues to be updated. The most recent update was in December 2023, announcing that detailed design will begin again in 2024 and that construction is anticipated to start in 2025.

8.2 What We Have Heard So Far

Because the project was suspended and restarted only recently, there are currently no additional updates to what was provided in the EIA report.

8.3 Next Steps

A public engagement session is being planned to be held with the Old Glenora Conservation Association and the Edmonton Historical Board in the Glenora area in late May or early June 2024. Additionally, another project update is currently being compiled for the Wellington Bridge Replacement webpage.

9 CONCLUSION

Wellington Bridge was constructed in 1932 and must now be replaced. The replacement is anticipated to begin two years sooner than initially anticipated in the EIA report. The preliminary design for the modern concrete arch bridge has been updated, and the project is proceeding into detailed design.

The major environmental sensitivities in the project area continue to include steep slopes with landslide areas, an unnamed watercourse, vegetation in Ramsey Ravine, bird nesting habitat, and a bat colony maternity roost within the existing bridge. These environmental sensitivities require mitigation measures during the planning, design, and construction phases of the project.

Mitigation measures relevant to planning and detailed design include:

- Following applicable geotechnical recommendations made by Thurber and consulting with Thurber during detailed design;
- Commissioning an Alberta Land Surveyor to survey for the bed and shore in the unnamed watercourse; obtaining relevant permits under the *Public Lands Act*;
- Minimizing the footprint in Ramsey Ravine required for project infrastructure and construction;
- Applying for an amendment to the *Historical Resources Act* approval for additional project area to be used as temporary workspaces;
- Applying for a letter of authorization under the *Wildlife Act* to remove the maternity roost through installing exclusion measures on the bridge and demolishing the bridge;
- Coordinating vegetation removal requirements with the City's Urban Forester and Natural Area Operations team, and developing a Tree Preservation Plan following the City's requirements;



Memo To: Achyut Adhikari

May 17, 2024

- 12 -

- Developing a naturalized restoration plan for areas of Ramsey Ravine that are temporarily disturbed by construction, and including the use of native topsoil, if possible, and deep-rooting, native woody plant species in the restoration;
- Scheduling the removal of vegetation and temporary shoring system and the demolition of Wellington Bridge outside the general nesting period from mid-April to late-August, and ensuring that pre-construction wildlife sweeps are completed by qualified professionals; and
- Implementing and monitoring bat exclusion measures on the bridge before it is demolished, and installing bat boxes as supplemental alternative habitat, as outlined in the bat mitigation plan ([Appendix E](#)).

During the construction phase, the contractor will be responsible for adhering to general construction mitigation measures. These mitigation measures will be outlined in a project-specific Environmental Construction Operations (ECO) Plan that is accepted by the City and by Associated, as the City's representative. As part of the ECO Plan, the contractor shall be required to develop an erosion and sediment control plan that is endorsed by a Certified Profession in Erosion and Sediment Control. The contractor is responsible for routine environmental inspections and maintenance throughout the construction phase of the project.

Wellington Bridge can be replaced with minimal environmental impacts for most of the environmental sensitivities if mitigation measures are followed; however, the long-term residual impacts to bats are unknown due to the nature of their ecology.

Comments and conditions from the City's Planning and Environment Services branch sign-off letter for the EIA report ([Appendix A](#)), as well as comments and conditions from review of this memo, will continue to be incorporated into the planning, design, and construction phases of the project, as applicable.

Memo To: Achyut Adhikari

May 17, 2024

- 13 -

10 CLOSURE

This memo was prepared for the City of Edmonton to support the City's Planning and Environment Services branch's environmental review process to satisfy the requirements of Bylaw 7188.

The services provided by Associated Engineering Alberta Ltd. in the preparation of this memo were conducted in a manner consistent with the level of skill ordinarily exercised by members of the profession currently practising under similar conditions. No other warranty expressed or implied is made.

Respectfully submitted,

Associated Engineering Alberta Ltd.

Prepared by:



Erica Graham, M.Sc., P.Biol.
Regulatory Planner

Reviewed by:



Shane Cote, P.Ag.
Manager, Environmental Planning and Compliance

ATTACHMENTS:

Appendix A – Wellington Bridge Replacement Environmental Impact Assessment, with the City's Sign-off Letter
(Reference No. 407852315-001)

Appendix B – Updated Figures

- **Figure 1:** Project Overview and Zoning
- **Figure 2:** Surface Water
- **Figure 3:** Vegetation
- **Figure 4:** Wildlife

Appendix C – Hazardous Building Materials Testing Report

Appendix D – Updated Preliminary Design Drawings

Appendix E – Wellington Bridge Replacement Bat Mitigation Plan

Achyut Adhikari

APPENDIX A – WELLINGTON BRIDGE REPLACEMENT ENVIRONMENTAL IMPACT ASSESSMENT

January 10, 2022
File: 2020-3858

Kyle Payne

City Planning
City of Edmonton
7th Floor, 10111 - 104 Avenue NW
Edmonton, AB T5J 0J4

Re: WELLINGTON BRIDGE REPLACEMENT ENVIRONMENTAL IMPACT ASSESSMENT

Dear Mr. Payne:

We received the City's sign-off letter for the Wellington Bridge Replacement Environmental Impact Assessment report dated December 1, 2021 (Reference No. 407852315-001). Comments and conditions outlined in the sign-off letter will be carried forward into the planning, design, and construction of the project.

In the sign-off letter, EPCOR Drainage inquired about whether they had been consulted about the drainage plan for this project. At the time of the submission of the EIA report detailed drainage drawings were not available. Drainage drawings will be included with the 90% submission of detailed design to the City and this information will be circulated to EPCOR Drainage for review.

The attached EIA report is updated with minor revisions to address comments in the City's sign-off letter. Table 1 below provides a summary of the minor revisions that are included in the EIA report. In addition, a copy of the City's sign-off letter is included in the EIA report as **Appendix F**.

If you have further questions, please don't hesitate to contact me directly (bodeuxb@ae.ca; 587-772-0619).

Yours truly,



Brett Bodeux, M.Sc., P. Biol.
Environmental Scientist

BB

Table 1
Summary Associated Engineering Ltd.'s Updates to the Wellington Bridge EIA Report

City Reviewer	City Comment	Associated Engineering Ltd.'s Response
Natural Areas Operations	Please update the Corporate Tree Management Policy number to C456C.	Reference to the City's Corporate Tree Management Policy has been updated to C456C.
Natural Areas Operations	Please be aware that owl and raptor nesting season begins on February 15th and goes till April 15th. Disturbance should be minimized during this time and any vegetation removal will require a nest sweep be completed by a Professional Biologist.	Text in the first paragraph of Section 3.4.1 Wildlife Zones has been updated to address this comment. In addition, text in the "Mitigation Measures for Planning and Design Phase" column and "Wildlife – Bird nesting on existing bridge infrastructure and in vegetation within the project area" row of Table 6-6 has been updated accordingly.

REPORT

City of Edmonton

Wellington Bridge Replacement Environmental Impact Assessment



JANUARY 2022

CONFIDENTIALITY AND © COPYRIGHT

This document is for the sole use of the addressee and Associated Engineering Alberta Ltd. The document contains proprietary and confidential information that shall not be reproduced in any manner or disclosed to or discussed with any other parties without the express written permission of Associated Engineering Alberta Ltd. Information in this document is to be considered the intellectual property of Associated Engineering Alberta Ltd. in accordance with Canadian copyright law.

This report was prepared by Associated Engineering Alberta Ltd. for the account of City of Edmonton. The material in it reflects Associated Engineering Alberta Ltd.'s best judgement, in the light of the information available to it, at the time of preparation. Any use which a third party makes of this report, or any reliance on or decisions to be made based on it, are the responsibility of such third parties. Associated Engineering Alberta Ltd. accepts no responsibility for damages, if any, suffered by any third party as a result of decisions made or actions based on this report.

TABLE OF CONTENTS

SECTION	PAGE NO.
Table of Contents	i
List of Tables	iii
List of Figures	iv
1 Introduction	1-1
1.1 Project Background	1-1
1.2 The Property	1-1
2 Environmental Assessment Methods	2-1
2.1 Desktop Assessments	2-1
2.2 Field Assessments	2-1
3 Environmental Context	3-1
3.1 Geology, Geomorphology, and Soils	3-1
3.2 Groundwater, Surface Water, and Fish Habitat	3-3
3.3 Vegetation	3-6
3.4 Wildlife	3-8
3.5 Historical Resources	3-15
4 Project Details	4-1
4.1 Single-Span Steel Girder Bridge	4-2
4.2 Three-Span Haunched Concrete Bridge	4-2
4.3 Modern Concrete Arch Bridge	4-2
5 Regulatory Framework	5-1
6 Project Impacts and Mitigation Measures	6-1
6.1 Environmental Impacts	6-1
6.2 Cumulative Impacts	6-5
6.3 Mitigation Measures	6-5
7 Environmental Monitoring	7-1
7.1 Construction	7-1
7.2 Post Construction	7-1
8 Public, Indigenous, and Stakeholder Engagement	8-1
8.1 Background and Engagement Approach	8-1
8.2 What We Have Heard So Far	8-2
8.3 Next Steps	8-4
9 Conclusion	9-1
Closure	
References	

Appendix A – Geotechnical Investigation
Appendix B - Historical Resources Approval
Appendix C - Preliminary Design Drawings
Appendix D - Crown Claim Inquiry Communications
Appendix E - Project Engagement Communication Plan
Appendix F - Planning and Environment Services Sign-Off Letter

LIST OF TABLES

PAGE NO.

Table 3-1 Summary of Wildlife Species Previously Recorded Within 2 km of the Project Area	3-10
Table 5-1 Anticipated Environmental Permitting Required for the Project	5-1
Table 5-2 Environmental Legislation and Recommendations for General Compliance	5-3
Table 6-1 Project Impacts on Geology, Geomorphology, and Soils	6-1
Table 6-2 Project Impacts on Groundwater, Surface Water, and Fish Habitat	6-2
Table 6-3 Project Impacts on Vegetation	6-3
Table 6-4 Project Impacts on Wildlife	6-3
Table 6-5 Project Impacts on Historical Resources	6-4
Table 6-6 Summary of Mitigation Measures to Address Environmental Impacts of Project	6-7

LIST OF FIGURES

	PAGE NO.
Figure 1-1 Project Overview and Zoning	1-3
Figure 3-1 View of active landslide northwest of Wellington Bridge	3-2
Figure 3-2 Surface Water	3-4
Figure 3-3 Outfall 125 in Unnamed Watercourse	3-5
Figure 3-4 Vegetation	3-7
Figure 3-5 Wildlife	3-14

1 INTRODUCTION

1.1 Project Background

Wellington Bridge is a three-span concrete arch bridge that carries 102 Avenue NW over the Ramsey Ravine in Edmonton, Alberta. The bridge was constructed in 1932 and is now in poor condition and has reached the end of its service life. Since 2014, the bridge has been supported by a temporary falsework system to safely maintain vehicle traffic until a replacement strategy can be undertaken. The City of Edmonton (City) retained Associated Engineering Alberta Ltd. (Associated) to complete preliminary design, detailed design, resident engineering, and post-construction services for the replacement of Wellington Bridge, including a shared-use path, on 102 Avenue over Ramsey Ravine. The Ramsey Ravine is part of the North Saskatchewan River Valley and within the North Saskatchewan River Valley Area Redevelopment Plan (ARP), Bylaw 7188 (City of Edmonton 2018) which requires environmental review.

This Environmental Impact Assessment uses the Terms of Reference for the North Saskatchewan ARP - A Guide to Completing Environmental Impact Assessments as a guide and is intended to support the City's review and approval of the project.

1.2 The Property

Wellington Bridge crosses over the Ramsey Ravine on 102 Avenue NW between Wellington Crescent NW and Churchill Crescent NW on lands that are owned by the City. During preliminary design, a project area was defined that includes space for demolition of the existing bridge and construction and operation of the new bridge structure which includes a shared-use path (Figure 1-1). The project area is in SE 01-053-25 W4M of the Alberta Township System (Figure 1-1).

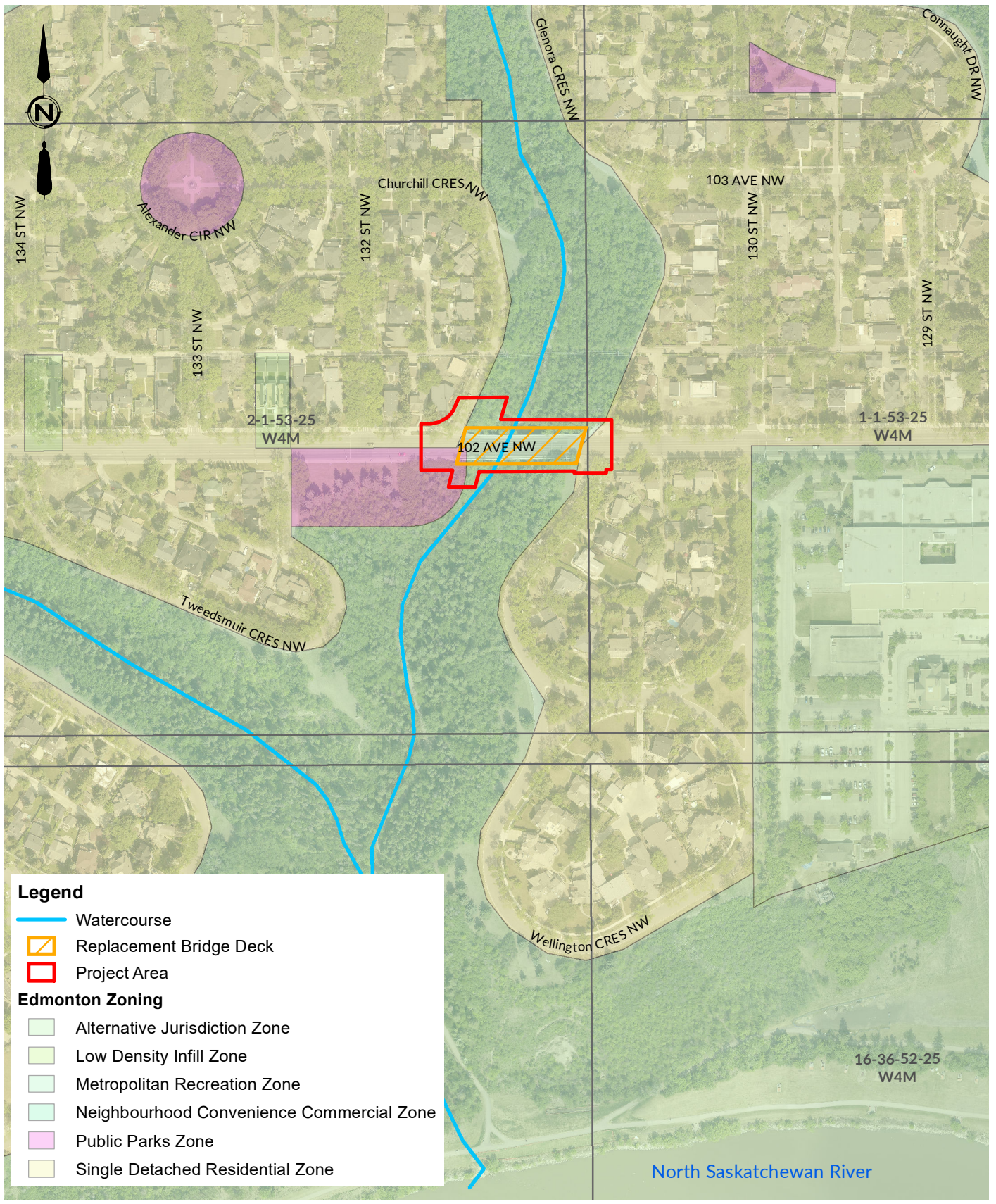
Lands uses in the project area include vehicle and pedestrian transportation on 102 Avenue NW, natural forested areas of the Ramsey Ravine, an unnamed watercourse at the bottom of the ravine, and pedestrian use of the multi-use trail at the bottom of the ravine. Wellington Bridge provides an important transportation connection to the City's downtown core.

Zoning of the lands within the project area includes Metropolitan Recreation Zone (A), Public Parks Zone (AP), and Single Detached Residential Zone (RF1) (Figure 1-1). As previously mentioned, the project area occurs within the North Saskatchewan River Valley and Ravine System overlay, which is regulated through Bylaw 7188 (City of Edmonton 2018).




The Environmental Site Assessment Repository does not show record of contamination in the vicinity of Wellington Bridge (Alberta Environment and Parks 2020). In addition, there is no evidence that lands in the project area occur over a historical landfill (MacLaren Plansearch Lavalin 1982; Alberta Environment 1988).

Overall, as the project area and surrounding lands include natural areas of the Ramsey Ravine and well-established residential communities, there is low potential for the occurrence of historical contamination. As such, a Phase I Environmental Site Assessment was not completed for the project. However, given the age of Wellington Bridge, there may be hazardous materials to manage during removal, such as lead paint or asbestos. Therefore, a Hazardous Building Materials Assessment, that includes samples of existing concrete to confirm if hazardous materials are present, is recommended prior to the tender phase of the project.







Details regarding the regulatory context of the project are provided in Section 5 of this report.



Legend

-  Watercourse
-  Replacement Bridge Deck
-  Project Area

Edmonton Zoning

-  Alternative Jurisdiction Zone
-  Low Density Infill Zone
-  Metropolitan Recreation Zone
-  Neighbourhood Convenience Commercial Zone
-  Public Parks Zone
-  Single Detached Residential Zone

SAVE DATE: 8/16/2021 11:35:47 AM SAVED BY:
DRAWING PATH: C:\2020-3858_EIA\EA_Report\1-1_ProjectOverviewZoning.mxd
DATA SOURCE: .



AE PROJECT No. 2020-3858
SCALE 1:3,500
APPROVED
DATE 2021AUG26
REV
DESCRIPTION ISSUED FOR REPORT

FIGURE 1 -1

CITY OF EDMONTON
WELLINGTON BRIDGE REPLACEMENT
PROJECT OVERVIEW AND ZONING

2 ENVIRONMENTAL ASSESSMENT METHODS

2.1 Desktop Assessments

The assessment involved a review of publicly available data and information to identify the baseline environment and potential environmental constraints within the project area. Sources of information included:

- Environmental Sensitivity Project, Model Data (City of Edmonton 2016);
- Alberta Flood Hazard Map Application (Government of Alberta 2020a);
- Alberta Conservation Information Management System (ACIMS) database (Government of Alberta 2019);
- Agricultural Regions of Alberta Soil Inventory Database (AGRASID) (Alberta Agriculture and Forestry 2020);
- Fisheries and Wildlife Management Information System (FWMIS) database (Government of Alberta 2020c);
- Listing of Historic Resources (Government of Alberta 2020d); and
- Urban Primary Land and Vegetation Inventory (City of Edmonton 2015).

2.2 Field Assessments

An assessment of the unnamed watercourse that crosses the project area was completed by Portia Lloyd (P.Biol.), of Associated on April 8, 2021. The purpose of the assessment was to characterize reaches of the unnamed watercourse and it followed methodologies outlined in the Roadway Watercourse Crossing Inspection Manual (Government of Alberta 2015a) and the Guide to the Code of Practice for Watercourse Crossings (Alberta Environment 2001).

Field assessments were completed within the project area by Associated staff Erin Cawthorn, BIT and Brett Bodeux, P.Biol., on June 16 and August 13, 2021. These assessments focused on vegetation, including rare plants, but also included incidental observations of wildlife and other notable environmental features within the project area.

A bat survey was completed on July 4, 2021, by Erin Cawthorn, BIT and Stephanie Findlay, P.Biol., of Associated to determine the presence or absence of bat roosts within the bridge structure. The survey included the use of passive and active acoustic detectors and infrared cameras. Survey methodology was completed in accordance with the Handbook of Inventory Methods and Standard Protocols for Surveying Bats in Alberta (AFWD 2010).

3 ENVIRONMENTAL CONTEXT

3.1 Geology, Geomorphology, and Soils

Detailed information on the geology and geomorphology of the project is provided in the geotechnical investigation report prepared by Thurber Engineering Ltd. (2021), which is attached as **Appendix A**. This report indicates that stratigraphy in the project area generally consists of glaciolacustrine clay that is underlain by clay till, sand of the Empress Formation, and clay shale bedrock of the Edmonton Group or sandstone bedrock (Thurber Engineering Ltd. 2021).

Surficial geology in the project area includes colluvium units on the slopes and at the bottom of the Ramsey Ravine. The colluvium units at the bottom of the Ramsey Ravine consist of a mixture of glacial till and glaciolacustrine deposits that include some sand, gravel, and cobbles. The colluvium units on the upper slopes consist primarily of glaciolacustrine deposits, which are susceptible to gradual seasonal creep where they contact areas of glacial till below. The interface of the glaciolacustrine deposits of the upper colluvium units and the glacial till of the lower

colluvium units is an area of typical groundwater discharge. Plateau areas at the top of the Ramsey Ravine consist primarily of glaciolacustrine deposits (Thurber Engineering Ltd. 2021).

Slopes in the project area are approximately 3H:1V with some sections approaching 2H:1V (Thurber Engineering Ltd. 2021). There are slope stability and erosion issues throughout the Ramsey Ravine including four landslide areas within and immediately adjacent to the project area. Most importantly, there is a landslide area in advanced stages to the northwest of Wellington Bridge, which has visible cracks and slide surfaces (Thurber Engineering Ltd. 2021; **Figure 3-1**). South of Wellington Bridge there is an advanced landslide area on the western slope of Ramsey Ravine and a slow mudflow landslide caused by groundwater discharge on the eastern slope (Thurber Engineering Ltd. 2021). To the northeast of Wellington Bridge, there is a shallow moving landslide area that is caused by seasonal effects (Thurber Engineering Ltd. 2021).

It is assumed that the slope stability issues are augmented by a series of drainage outlets, which release untreated stormwater directly into the ravine, including into an unnamed watercourse at the bottom of the ravine. In addition, water within the unnamed watercourse currently flows through a small diameter corrugated steel pipe culvert, which may be contributing to upstream ponding/erosion, downstream channel erosion, and bridge shoring/pile cap exposure.

The project area is in Soil Correlation Area 10 (Pedocan Land Evaluation Ltd. 1993), within the Thick Black Soil Zone of central Alberta. Information from AGRASID reveals that soils in the project area are miscellaneous undifferentiated mineral soils (Alberta Agriculture and Forestry 2020). Most of the soils are likely disturbed and consist of fill material given the extent of previous development and anthropogenic disturbance. Soils with naturally developed profiles likely occur in the undisturbed areas associated with the areas in the Ramsey Ravine adjacent to Wellington Bridge. Given the upland and forested characteristics of the Ramsey Ravine, the naturally developed soils are likely to be from the Luvisolic soil Order. Historical and current use of road salts on the bridge and adjacent roadway approaches have likely resulted in some degree of salinity impacts on soils within the project area.



Figure 3-1
View of active landslide northwest of Wellington Bridge

3.2 Groundwater, Surface Water, and Fish Habitat

3.2.1 Groundwater

Local groundwater levels range from 5.0 meters below ground surface (mbgs) and extend up to at least 35.2 mbgs (Thurber Engineering Ltd. 2021). However, groundwater conditions can vary seasonally and there may be perched groundwater levels near the surface (Thurber Engineering Ltd. 2021).

3.2.2 Surface Water

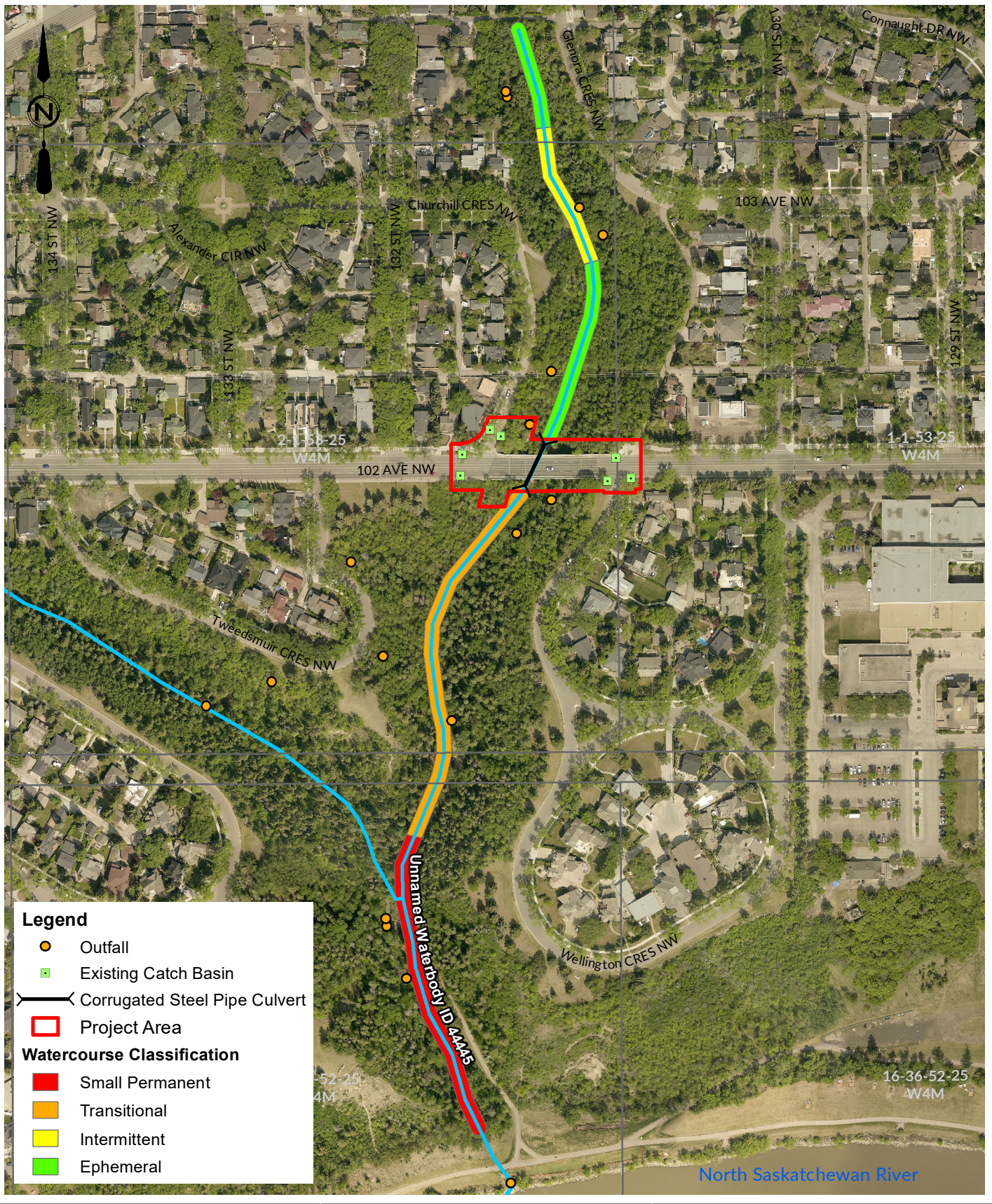
The project area occurs outside of the floodway and flood fringe of the North Saskatchewan River (Government of Alberta 2020a). The overall drainage within the Ramsey Ravine is to the south. Both the east and west banks slope steeply to the centre of the ravine where the topography becomes flatter and supports a shared-use path that crosses perpendicular beneath Wellington Bridge.

An unnamed watercourse (Water Body ID: 44445) bisects the project area and crosses under Wellington Bridge to the east of the shared-use path (**Figure 3-2**). This watercourse is a tributary to the North Saskatchewan River and is designated as a Class C watercourse with a restricted activity period from September 16 to July 31. Upstream of Wellington Bridge, the unnamed watercourse is ephemeral to intermittent. Where the unnamed watercourse crosses beneath Wellington Bridge, it is directed through a corrugated steel pipe culvert. South of Wellington Bridge, the unnamed watercourse is transitional and small permanent. There are gabion baskets between the shared-use path and the bottom of the unnamed watercourse downstream of Wellington Bridge with signs of significant erosion along the eastern bank. Immediately upstream of Wellington Bridge, there is extensive rip rap and Outfall 125 discharges stormwater into the unnamed watercourse. There are at least nine outfall structures connected to the unnamed watercourse from its origin upstream of Wellington Bridge to its confluence with the North Saskatchewan River (**Figure 3-2**).

Aside from the unnamed watercourse, there are no other surface water features, such as wetlands, within the project area. However, there are four catch basins on 102 Avenue NW on the approach to Wellington Bridge (**Figure 3-2**). These catch basins convey stormwater into the unnamed watercourse within the Ramsey Ravine. There is evidence of erosion from stormwater within the project area, especially at the northwest and southwest corners of the bridge abutments. It appears that the existing grading and catch basins are insufficient at capturing stormwater runoff from the adjacent roads and bridge deck, leading to stormwater runoff directly into the Ramsey Ravine.

3.2.3 Fish Habitat

Within the project area, the unnamed watercourse is ephemeral and transitional and lacks surface water for most of the year. As such, there is limited potential for fish habitat in this water body. In addition, there is a barrier to fish movement downstream of Wellington Bridge where extensive rip rap occurs along the south-facing slope of a paved trail (**Figure 3-2**). The unnamed watercourse may be considered fish-bearing in the section where it is a small permanent stream; however, this is outside of the project area. There are no results from the FWMIS database of fish inventories or habitat assessments at the unnamed watercourse.



SAVE DATE: 8/30/2021 3:22:18 PM. SAVED BY: [unclear]
DRAWING PATH: [unclear]
DATA SOURCE: [unclear]

Associated Engineering
BEST MANAGED COMPANIES
Platinum member

0 50 100 Meters

AE PROJECT No.	2020-3858
SCALE	1:3,500
APPROVED	
DATE	2021SEP01
REV	
DESCRIPTION	ISSUED FOR REPORT

FIGURE 3-2
CITY OF EDMONTON
WELLINGTON BRIDGE REPLACEMENT
SURFACE WATER



Figure 3-3
Outfall 125 in Unnamed Watercourse

3.3 Vegetation

3.3.1 General Vegetation in the Project Area

According to the City's Urban Primary Land and Vegetation Inventory, the project area consists of naturally wooded areas classified as forested stand types and developed areas classified as established residential communities (City of Edmonton 2021). Within the project area, there is an open area of maintained grass at the crest of the ravine on the southeast side of Wellington Bridge. To the northwest of Wellington Bridge, outside the project area, there is another open area of maintained grass where the shared-use path from the ravine connects with Churchill Crescent NW. There are landscape trees along 102 Avenue NW, Churchill Crescent NW, and Wellington Crescent NW (Figure 3-4).

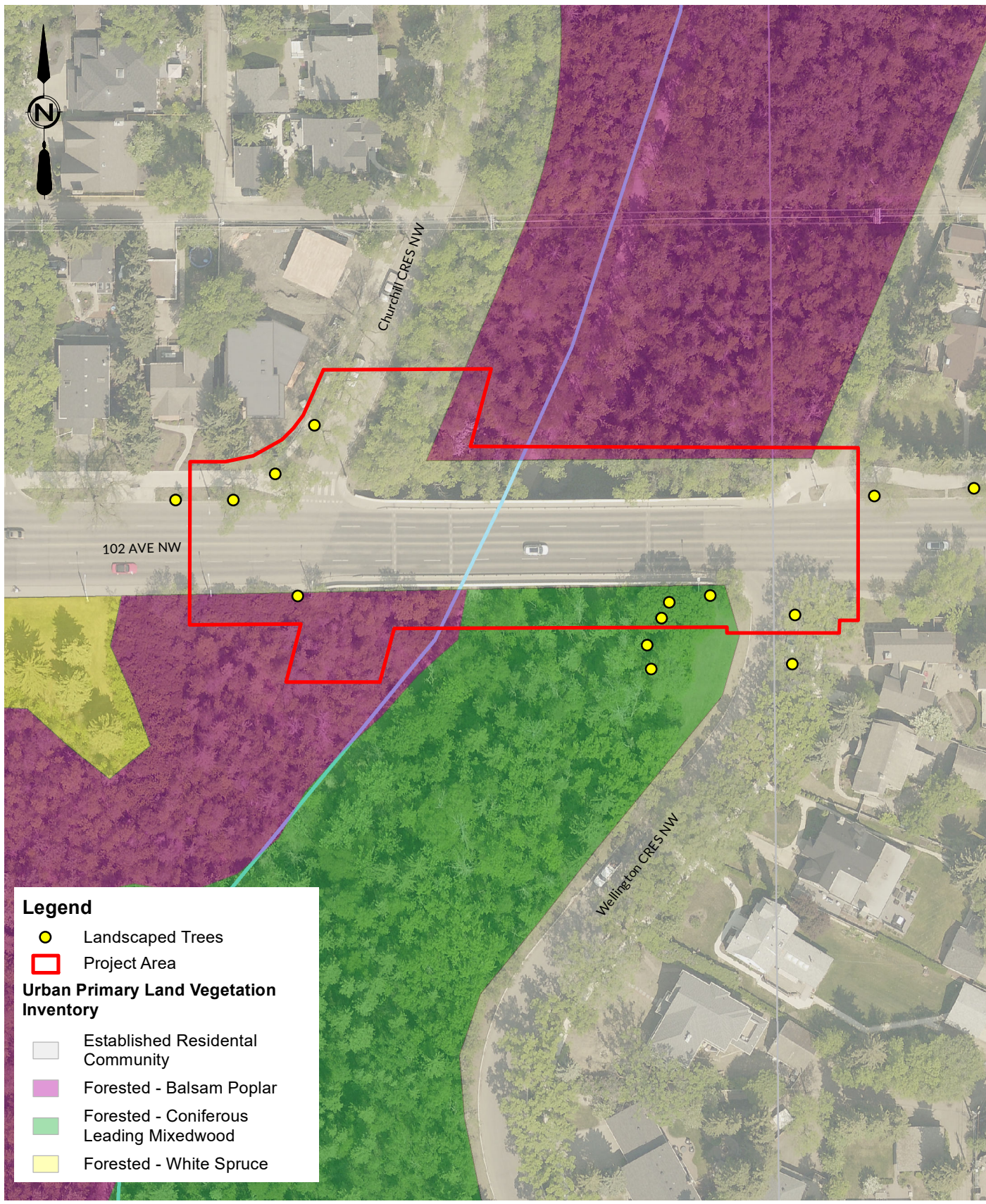
Forested areas surrounding Wellington Bridge are deciduous dominated consisting of balsam poplar (*Populus balsamifera*), green ash (*Fraxinus pennsylvanica*), Manitoba maple (*Acer negundo*), trembling aspen (*Populus tremuloides*), western mountain-ash (*Sorbus scopulina*), and occasional white spruce (*Picea glauca*). There are also saplings of American elm (*Ulmus americana*) and burr oak (*Quercus macrocarpa*) in the project area. The understory is dominated by shrubs including beaked hazelnut (*Corylus cornuta*), buckbrush (*Symphoricarpos occidentalis*), choke cherry (*Prunus virginiana*), high-bush cranberry (*Viburnum opulus*), prickly rose (*Rosa acicularis*), and saskatoon (*Amelanchier alnifolia*). Several exotic shrubs including common caragana (*Caragana arborescens*), common lilac (*Syringa vulgaris*), and Peking cotoneaster (*Cotoneaster lucidus*) occur in the project area. Herbaceous plants within the project area include common dandelion (*Taraxacum officinale*), common horsetail (*Equisetum arvense*), showy aster (*Eurybia conspicua*), smooth brome (*Bromus inermis*), star-flowered Solomon's-seal (*Maianthemum stellatum*), and wild sarsaparilla (*Aralia nudicaulis*). Due to the dense shrub layer, herbaceous plants occurring in the understory are somewhat limited. Overall, the vegetation in the project area is characteristic of an area that has been influenced by human disturbance given the occurrence and cover of many non-native species.

3.3.2 Rare Plants

Two non-sensitive element occurrences are known from lands within Alberta Township Survey Section 01-053-25-W4M, which encompasses the project area, including Canada Brome (*Bromus latiglumis*) and Smooth Sweet Cicely (*Osmorhiza longistylis*) (Alberta Parks 2019). Neither of these species was observed in the project area during the field assessments.

3.3.3 Regulated Weeds

Populations of several weed species including creeping bellflower (*Campanula rapunculoides*), creeping thistle (*Cirsium arvense*), perennial sow-thistle (*Sonchus arvensis*), and white cockle (*Silene latifolia*) occur in the project area. These species are listed as noxious and are regulated under the *Alberta Weed Control Regulation* (Alberta Reg. 19/2010) of the *Weed Control Act* (S.A. 2008, c. W-5.1).



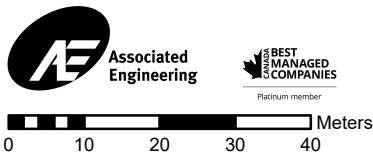
Legend

- Landscaped Trees
- Project Area

Urban Primary Land Vegetation Inventory

- Established Residential Community
- Forested - Balsam Poplar
- Forested - Coniferous Leading Mixedwood
- Forested - White Spruce

SAVE DATE: 03/30/2021 12:03:43 PM SAVED BY:
DRAWING PATH: C:\2020\3858_EIA\EA_Report\fig 3-4_Vegetation.mxd
DATA SOURCE: .



AE PROJECT No.	2020-3858
SCALE	1:1,000
APPROVED	
DATE	2021AUG30
REV	
DESCRIPTION	ISSUED FOR REPORT

FIGURE 3-4
CITY OF EDMONTON
WELLINGTON BRIDGE REPLACEMENT
VEGETATION

3.4 Wildlife

3.4.1 Wildlife Zones

The project area occurs in the B4 Nesting Zone where the general bird nesting period is from mid-April to late-August (Government of Canada 2018). Migratory bird nesting potential is moderate to high in vegetated areas of the Ramsey Ravine. Some non-migratory birds, such as certain species of raptors, initiate nesting before mid-April. For example, the Great Horned Owl (*Bubo virginianus*) is known to begin nesting in Alberta as early as mid-February. The project area contains potential nesting habitat for early nesting bird species.

Wildlife sensitivity maps show that the project area is within the Sensitive Raptor Range for Bald Eagle (*Haliaeetus leucocephalus*) and the range of Sharp-tailed Grouse (*Tympanuchus phasianellus*) (Government of Alberta 2021b; **Figure 3-5**). In addition, the project area occurs in a Key Wildlife and Biodiversity Zone in Alberta (Government of Alberta 2021b **Figure 3-5**). Although the North Saskatchewan River valley offers potential nesting habitat for Bald Eagles, they typically nest in tall trees above the main canopy and avoid heavily developed areas (Cornell University 2019). Given the lack of tall trees above the forest canopy and the extensive development around the project area, Bald Eagles are not anticipated to nest in the project area. Sharp-tailed Grouse leks typically occur in open areas with short, sparse vegetation within landscapes dominated by agricultural production (Stavne 2006). Given their habitat requirements and the urban setting, the presence of Sharp-tailed Grouse leks near the project area is unlikely.

Most of the lands within the project area are considered moderate to high value according to the City's Environmental Sensitivities database (City of Edmonton 2016; **Figure 3-5**). There are small areas of habitat that are considered very high and extremely high value (City of Edmonton 2016; **Figure 3-5**).

3.4.2 Wildlife Corridors and Movement

The project area does not include terrestrial, summer or winter pinch points, or arboreal pinch points (City of Edmonton 2016); however, wildlife almost certainly travels through the Ramsey Ravine passing beneath Wellington Bridge. Likely, most of the wildlife that frequently moves through the Ramsey Ravine are birds and small to medium sized mammals. Given the extensive development north of 102 Avenue NW and the small portion of the Ramsey Ravine that extends to the north of Wellington Bridge, there is limited potential for large mammals to enter and pass through the project area, especially from the north. However, large mammals may occasionally move north through the Ramsey Ravine and the project area. They may also travel from the Groat Ravine to the east and pass through the project area from north to south.

Currently, there are trails into the Ramsey Ravine at all four corners of Wellington Bridge, which are likely predominantly from human use. In addition, several trails extend through the ravine, mainly on the east side (**Figure 3-5**). These trails are accessible to wildlife and most terrestrial wildlife movement likely occurs east of the shared-use path below the bridge.

Beneath the existing bridge structure there are three separate open spaces that provide passage for wildlife. As such, three separate openness ratios are calculated for each of the passages. Given that these passages are not square in cross-section, the openness ratio calculation is modified to represent the cross-sectional area of open space, which is analogous to height x width of the original equation, divided by the length of the wildlife passage (i.e., width of the proposed bridge deck). The central open space between the two arch piers has a cross-sectional area of 166 m² leading to an openness ratio of 10.2. The two open spaces that are adjacent to the abutments have the same cross-sectional area of 26 m², leading to an openness ratio of 1.6 for each opening. The temporary falsework system

beneath the bridge substantially reduces the existing openness ratio and therefore it is potentially limiting wildlife movement under the bridge.

3.4.3 Wildlife Observations

3.4.3.1 General Wildlife

The FWMIS database (Government of Alberta 2021a) revealed nine terrestrial wildlife species recorded within a 2 km radius of the project area. A summary of these species, their conservation concern and status, preferred habitat, and potential to occur in the project area is provided in [Table 3-1](#).

Incidental wildlife observations included American Robin (*Turdus migratorius*), Black-billed Magpie (*Pica hudsonia*), Black-capped Chickadee (*Poecile atricapillus*), Common Raven (*Corvus corax*), Downy Woodpecker (*Dryobates pubescens*), Red-eyed Vireo (*Vireo olivaceus*), Rock Pigeon (*Columba livia*), and Yellow Warbler (*Setophaga petechia*). During the late season field survey, a hatch year Red-eyed Vireo was observed begging for food and subsequently being fed by an adult suggesting that there was an active Red-eyed Vireo nest in the vicinity of the project area during the 2021 breeding season. Rock Pigeons were observed flying in and out of the underside of the bridge during both field surveys suggesting that they were actively using the bridge structure for a nest site in the 2021 breeding season.

Two stick nests were observed on top of the temporary falsework system during the late season field survey. These stick nests were likely constructed and used by Common Raven based on the size, shape, and occurrence of two individual Common Raven nearby. In addition, two tree snags with multiple cavities (i.e., wildlife trees) occur in the project area although these do not appear to be actively used by wildlife for nesting ([Figure 3-5](#)).

**Table 3-1
Summary of Wildlife Species Previously Recorded Within 2 km of the Project Area**

Common Name (Scientific Name)	General Status of Alberta Wild Species (Government of Alberta 2015b)	Wildlife Act	Species At Risk Act	COSEWIC Status (Government of Canada 2019)	Preferred Habitat and Potential to Occur in Project Area
Barred Owl (<i>Strix varia</i>)	Sensitive	Special Concern	NA	NA	Mixed forests with large trees and often near water (Cornell Lab of Ornithology 2019). Although the habitat within the project area corresponds with preferred habitat for this species, there is a lack of large diameter deciduous trees or snags that could provide cavities for nesting so the potential for this species to occur in the project area is low to moderate.
Bay-breasted Warbler (<i>Setophaga castanea</i>)	Sensitive	NA	NA	NA	Mature boreal forest dominated by coniferous trees but occasionally in mixedwood forest. Typically nest in dense spruce trees (Cornell University 2019). There is low potential for this species to occur in the project area due to the limited coniferous tree cover.
Cape May Warbler (<i>Setophaga tigrina</i>)	Sensitive	NA	NA	NA	Mature coniferous forest (Cornell University 2019). There is low potential for this species to occur in the project area due to the limited coniferous tree cover.
Sharp-tailed Grouse (<i>Tympanuchus phasianellus</i>)	Sensitive	NA	NA	NA	Dense, shrubby areas for nesting and open and elevated areas for leks (Cornell University 2019). There is low potential for this species to occur in the project area as the preferred habitat is not suitable.

Common Name (Scientific Name)	General Status of Alberta Wild Species (Government of Alberta 2015b)	Wildlife Act	Species At Risk Act	COSEWIC Status (Government of Canada 2019)	Preferred Habitat and Potential to Occur in Project Area
Short-eared Owl (<i>Asio flammeus</i>)	May Be at Risk	NA	Special Concern	Threatened	Nest on the ground in large, open areas with low vegetation, including prairie grasslands, meadows, marshes, and agricultural areas (Cornell Lab of Ornithology 2019). There is low potential for this species to occur in the project area as the preferred habitat is not suitable.
Western Tanager (<i>Piranga ludoviciana</i>)	Sensitive	NA	NA	NA	Open coniferous or mixedwood forests (Cornell University 2019). There is low potential for this species to occur in the project area due to the limited coniferous tree cover.
Cougar (<i>Puma concolor</i>)	Secure	NA	NA	NA	Have large ranges and use most habitats within their range that provide cover and prey (Kays and Wilson 2009). Although Cougar may occasionally move through the project area it is unlikely they would remain for a significant amount of time given their large home range requirements.
Little Brown Bat (<i>Myotis lucifugus</i>)	May Be At Risk	NA	Endangered	Endangered	Roost in anthropogenic structures (buildings, bridges, bat houses), tree cavities, and/or rock crevices. Colonial roosting species (AFWD 2010). The potential for this species to occur in the project area is high as the existing bridge structure provides suitable roosting habitat.

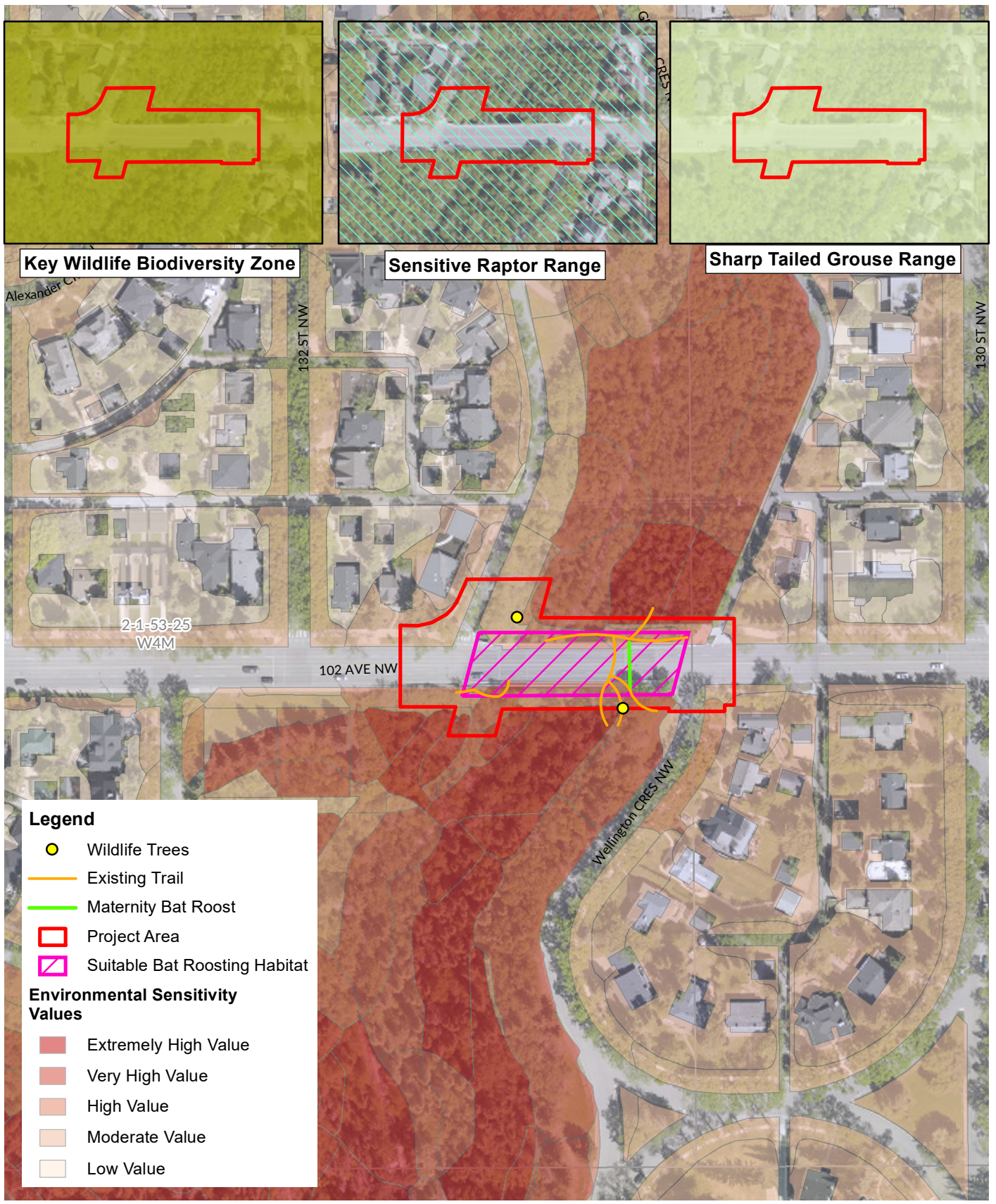
Common Name (Scientific Name)	General Status of Alberta Wild Species (Government of Alberta 2015b)	<i>Wildlife Act</i>	<i>Species At Risk Act</i>	COSEWIC Status (Government of Canada 2019)	Preferred Habitat and Potential to Occur in Project Area
Northern Long-Eared Bat (<i>Myotis septentrionalis</i>)	May Be At Risk	NA	Endangered	Endangered	Roost in tree cavities or under peeling bark primarily within the Boreal forest. Occasionally found in Peace Parkland and Central Parkland subregions. Colonial roosting species (Caceres and Pybus 1997). The potential for this species to occur in the project area is low as Edmonton is at the northern extreme of their range.

3.4.3.2 Bats

The bat survey identified that bats actively roost in gaps/cracks of Wellington Bridge. A maternity colony roost was present in a small gap adjacent to the abutment on the east side of the bridge. In addition, some bats were using a crack between the concrete on the underside of the bridge, west of the pedestrian pathway, as a roost.

A large amount of guano accumulated beneath the maternity colony roost at the east bridge abutment, which indicates frequent use by many individuals and re-use over several years. Two living bat pups, one female and one male, were observed below the maternity colony roost at the east bridge abutment. These pups were young-of-the-year and at least one of the pups was retrieved by the mother after sunset.

At least, 26 individuals were counted during the point count survey on July 4, 2021, although there are likely more individuals in the maternity colony roost. Based on the frequency of the echolocation calls, two species of bats appeared to be using the maternity colony roost. Low frequency calls (i.e., 20-40 kHz) indicate a large-bodied bat species and high frequency calls (i.e. 50-80 kHz) indicate a small-bodied bat species. Both low and high frequency echolocation calls were recorded emerging from the maternity roost. The high frequency calls likely belong to either the Little Brown Bat (*Myotis lucifugus*) or the Northern Long-eared Bat (*Myotis septentrionalis*) and the low frequency calls likely represent the Big Brown Bat (*Eptesicus fuscus*). Two adult carcasses of a small-bodied bat species were located at the base of the maternity colony roost; however, species identification of these individuals was not possible. Carcasses were collected if species identification was required through genetic testing. Additionally, feces were collected at three locations beneath the bridge for potential species identification, if needed. Little Brown Bat or the Northern Long-eared Bat are both listed as Endangered under the *Species At Risk Act* (Table 3-1); therefore, the roosting locations in Wellington Bridge are considered critical habitat.



Legend

- Wildlife Trees
- Existing Trail
- Maternity Bat Roost
- Project Area
- Suitable Bat Roosting Habitat

Environmental Sensitivity Values

- Extremely High Value
- Very High Value
- High Value
- Moderate Value
- Low Value

SAVE DATE: 02/26/2021 11:28:17 AM SAVED BY: DRAWING PATH: C:\2020\3858_EIA\EA_Report\fig 3-5_Wildlife.mxd DATA SOURCE: .

AE PROJECT No.	2020-3858
SCALE	1:2,000
APPROVED	
DATE	2021AUG30
REV	
DESCRIPTION	ISSUED FOR REPORT

FIGURE 3-5
CITY OF EDMONTON
WELLINGTON BRIDGE REPLACEMENT
WILDLIFE

3.5 Historical Resources

Historical resources relative to the project area were reviewed to support an application for Approval under the *Historical Resources Act*. This application was submitted on March 8, 2021, ([Appendix B](#)) and the review of historical resources revealed that the project occurs on lands assigned with the following Historic Resource Values:

- 5 for palaeontology as it is in an area with high potential for palaeontological resources;
- 5 for archaeology due to the proximity of historic resource site FjPj-78; and
- 2 due to the proximity of known historic resource site O'Connor/Farnell Residence.

Wellington Bridge is listed as part of the Inventory of Historic Resources in Edmonton. As it was constructed in 1932, Wellington Bridge is a well-established and important feature in the Glenora community and is valued by many residents.

4 PROJECT DETAILS

Rehabilitation and widening of the existing bridge and replacement with a “like-for-like” were considered during preliminary design; however, these options were determined to not be feasible. Instead, three replacement options were selected for consideration during preliminary design including a single-span steel plate girder bridge, a three-span haunched concrete slab bridge, and a modern single-span concrete arch. Preliminary design drawings are included in [Appendix C](#) and an overview of each replacement option is described in the subsections below. Through preliminary design, Associated Engineering Alberta Ltd. (2021) recommends that the City advances the modern arch bridge to detailed design; however, the replacement option will be reviewed by City Council for support and approval.

All three replacement options are anticipated to require a similar footprint for construction and operation, which is encompassed within the project area. Regardless of the option selected, replacement will include widening of the bridge and accommodating a new shared-use path on the north side of the bridge parallel with 102 Avenue NW. The multi-use trail beneath the bridge may be left in place or realigned, depending on the extent of open space upgrades selected. In addition, the culvert removal and reinstatement of an open channel within the unnamed watercourse beneath the bridge will be considered during the detailed design phase of the project. For all replacement options, rip rap on geotextile will be installed at certain locations on the head slopes beneath the bridge deck. The use of underdeck lighting is not recommended for this project as it has the potential to interfere with wildlife using habitats in the Ramsey Ravine. Overhead lighting will be similar for all bridge replacement options with 16 streetlights on each side of the bridge (32 streetlights total) with an approximate spacing of 3.66 m between each light pole.

It is expected that the primary laydown area will be on the closed portion of 102 Avenue immediately adjacent to the bridge. There may be some encroachment onto the boulevards and surrounding paths at the top of the ravine. Some laydown of materials within the ravine should be expected during construction. Due to the size of the existing bridge, it is expected that relatively large demolition equipment will require access to the Ramsey Ravine. Heavy equipment and falsework systems will be required within Ramsey Ravine for the construction of piers and foundations of the three-span haunched concrete slab bridge and modern concrete arch bridge, respectively. In contrast, the single-span steel plate girder bridge does not require heavy equipment within the Ramsey Ravine to support the construction of the new bridge although heavy equipment, including large cranes, are required at the top of the ravine to facilitate girder erection.

The sequence and general schedule for construction are similar for all three replacement options. The estimated timeline of construction includes the following milestones:

- Contractor mobilization: September to mid-November 2027
- Demolition: commencing September to December 2027
- Substantial Completion: Fall 2028
- Seasonal Deficiencies: Spring 2029

As the bridges age, the use of a Snooper vehicle and/or aerial work platform may be required for inspections. Minor pruning of vegetation and equipment access into the Ramsey Ravine may be required to facilitate these inspections; however, these activities are not anticipated to result in significant environmental impacts.

Regular maintenance is similar for all three replacement options and primarily consists of snow clearing on the bridge deck. Long-term maintenance of the bridge deck is anticipated at about 20-30 years and more major rehabilitation of the bridge deck around 40-60 years. The steel girder bridge replacement option does not have conventional joints at

the abutments due to the use of a semi-integral abutment. For this option, crack sealing at the cycle control joints is expected every 5 years. Both the concrete three-span haunched concrete slab bridge and modern concrete arch bridge replacement options would have conventional gland joints. These would be inspected by the City at regular intervals for signs of leakage. Replacement of the joints is required once they are no longer functioning to prevent water leakage to the bridge structure elements and the ground surface below. Replacement is typically required every 10-15 years.

4.1 Single-Span Steel Girder Bridge

The single-span steel girder bridge will have eight girder lines that clear span the ravine with a span of 49 m. The deck will be a 225 mm thick cast-in-place concrete slab with the standard Alberta Transportation waterproofing system and two 40 mm lifts of asphalt. The single-span option removes the need for foundations and piers in the valley and opens up the valley for users, vegetation, and wildlife. The span length is suitable for the use of semi-integral abutments with the ends of the steel girders cast into the concrete abutment backwall. All pile foundations and abutment components will be cast-in-place concrete. The steel girders will be haunched to give some aesthetic interest.

4.2 Three-Span Haunched Concrete Bridge

The three-span concrete slab bridge option comprises a post-tensioned cast-in-place slab bridge. This bridge type allows for the thickness of the slab to be shallow compared with girder bridges, and the slab will be haunched at the pier locations for structural capacity requirements and the complimentary aesthetic appeal. For this option to be structurally feasible the span length needs to be kept reasonably low and the spans need to balance. The span arrangement for this option is 20 m, 27 m, and 20 m. Therefore, two piers will need to be installed in the Ramsey Ravine. The locations of the abutments and the piers in the ravine will be similar to those of the existing structure.

4.3 Modern Concrete Arch Bridge

The modern concrete arch bridge has a total length of 48 m between the centreline of abutment bearings. The deck is supported by inclined struts that connect to the tapered and inclined arch ribs below. The purpose of the inclination of the ribs is to reduce any tunnel-like effect resulting from the widening of the bridge and allow for the passage of as much light as possible beneath the bridge deck. The creation of openings between the ribs at the ground level provides visibility through the arches and reduces the creation of hidden places and the associated public safety concerns. The inclined struts and tapered, inclined ribs also provide visual interest. The use of inclined struts eliminates the need for an additional foundation on the head slope between the base of the rib and the abutment, it also reduces the horizontal reaction at the base of the arch rib thus reducing the lateral demand on the piles.

5 REGULATORY FRAMEWORK

A summary of completed and anticipated permitting requirements for the project is provided in [Table 5-1](#). This summary is based on a review of environmental sensitivities, preliminary design information, and the current project area. These regulatory requirements should be revisited throughout project planning and detailed design as they are subject to change.

A Historic Resources Approval (HRA Number: 4715-20-0061-003) for the project area was issued on April 13, 2021 ([Appendix B](#)). This Approval is subject to conditions including submission of a new Historic Resources Application before the onset of development if infrastructure or activities extend outside of the project area and the documentation of Wellington Bridge as a historic structure prior to any development-related impact. Documentation of Wellington Bridge as a historic structure was submitted to Alberta Culture, Multiculturalism and Status of Women on August 13, 2021 ([Appendix B](#)).

An inquiry was submitted to Alberta Environment and Parks Water Boundaries Unit on April 23, 2021, regarding the potential for the unnamed watercourse beneath Wellington Bridge to be claimed by the Crown. The Water Boundaries Unit responded to this inquiry on July 20, 2021, and follow-up questions on August 24, 2021 ([Appendix D](#)). The extent of the Crown claim portion of the unnamed watercourse, which is referred to Wellington Creek in the correspondence from the Water Boundaries Unit, is unknown and needs to be confirmed within the project area by an Alberta Land Surveyor. Given this uncertainty, it is assumed that there is bed and shore associated with the unnamed watercourse within the project area and activities are subject to the *Public Lands Act* ([Table 5-1](#)).

Additional permitting under the provincial *Wildlife Act* requires consultation with a Wildlife Biologist from Alberta Environment and Parks. Potential permitting may be required under the federal *Species At Risk Act* and consultation with the Canadian Wildlife Service; however, this will be determined after consultation with Alberta Environment and Parks during the detailed design phase of the project. Prior to demolition of the bridge, consultation with Alberta Environment and Parks is required as an approval or exemption is likely needed.

[Table 5-2](#) provides an overview of environmental legislation with recommendations and general practices to promote project compliance. Recommendations for project compliance are most relevant to the construction phase of the project and are important for the contractor to be aware of and incorporate into their project-specific Environmental Construction Operations (ECO) Plan.

Table 5-1
Anticipated Environmental Permitting Required for the Project

Legislation / Approval Type	Trigger	Notes on Requirements	Estimated Agency Review Timeline
Municipal			
City of Edmonton Bylaw 7188 (North Saskatchewan River Valley Area Redevelopment Plan) / Approval	Projects with components and/or activities within the North Saskatchewan River Valley and Ravine System Protection Overlay are subject to an environmental review process under Bylaw 7188.	Submission of this Environmental Impact Assessment report to City Planning for review and approval. This Environmental Impact Assessment needs to be approved by Council.	6-8 weeks

Legislation / Approval Type	Trigger	Notes on Requirements	Estimated Agency Review Timeline
Provincial			
<i>Environmental Protection and Enhancement Act / Notification</i>	Extensions or replacements of existing stormwater or wastewater collection systems are required under the <i>Wastewater and Storm Drainage Regulation (Alberta Regulation 119/1993)</i> of this Act.	Stamped and signed design drawings are required for submission of notifications.	10 weeks (Notification period prior to the start of construction)
<i>Historical Resources Act / Approval</i>	Ground disturbance activities with potential to disturb historical resources.	HRA Number: 4715-20-0061-003 was obtained on April 13, 2021. If the footprint of the project changes in detailed design a new Approval must be obtained.	6 to 8 weeks
<i>Public Lands Act / Disposition(s)</i>	Activities within the bed and shore of the unnamed watercourse within the project area.	Temporary construction activities within the bed and shore of the unnamed watercourse require a Temporary Field Authorization. Footprints including associated temporary workspace are required for submission. Permanent occupation of the bed and shore of the unnamed watercourse, such as culverts or rip rap, requires a Licence of Occupation. A sketch plan, First Nations Consultation, and field vegetation information (e.g., tree clearing requirements) are required for submission.	2 to 4 weeks (Temporary Field Authorization) 8 to 12 months (Licence of Occupation)
<i>Water Act Code of Practice for Watercourse Crossings / Notification</i>	Replacement of Type 1 crossing structure with a Type 1 crossing structure.	Notifications are valid for one year less a day. For construction that occurs longer than one year, a renewal is required.	2 weeks (Notification period prior to the start of construction)
<i>Wildlife Act / Possible Approval or Exemption</i>	Demolition of Wellington Bridge, which is a known maternity roost habitat for bats.	Permitting requirements of the bridge demolition need to be confirmed with Alberta Environment and Parks.	Potential permitting requirements will be confirmed during the detailed design phase of the project.

**Table 5-2
Environmental Legislation and Recommendations for General Compliance**

Legislation	Recommendations and General Practices for Compliance
Municipal	
<p>Community Standards Bylaw 14600 (City of Edmonton 2020b) This Bylaw regulates noise within the City. Under this Bylaw, construction activity is restricted to a timeframe between 7 a.m. and 9 p.m. on most days other than Sundays and holidays when construction is restricted to a timeframe between 9 a.m. and 7 p.m.</p>	<p>Adhere to time restrictions for construction activities. Contact City representative if construction is required outside of these time periods.</p>
<p>Corporate Tree Management Policy C456C (City of Edmonton 2020a) This policy protects the tree canopy on City lands from destruction, loss, or damage. The Urban Forestry unit determines the financial value of ornamental trees based on their size, species, and condition, and the Natural Area Operations unit determines the valuation of areas of natural vegetation to be removed. These units coordinate vegetation removal activities.</p>	<p>Maintain engagement with Natural Areas Operations regarding vegetation removal requirements in the Ramsey Ravine. Engage Urban Forestry if the project will conflict with landscape trees. Require the contractor to develop a Tree Preservation Plan that is submitted and approved through Natural Areas Operations.</p>
<p>Drainage Bylaw 18093 (City of Edmonton 2019) This Bylaw regulates surface drainage on public and private land and fosters the well-being of the environment by prohibiting the release of dangerous or hazardous materials into the sewerage system.</p>	<p>Require the contractor to incorporate mitigation measures to prevent releases of prohibited wastes and control releases of restricted wastes into the sewerage system.</p>
<p>EPCOR Drainage Bylaw 18100 (City of Edmonton 2020c) The purpose of this Bylaw is to approve the terms and conditions for drainage services and a mechanism whereby Drainage Services Guidelines may be implemented by EPCOR Water Services Inc.</p>	<p>Obtain permission from EPCOR to use their infrastructure and ensure water quality meets the standards.</p>
<p>Parkland Bylaw 2202 This Bylaw regulates the conduct and activities of people on Parkland to promote the safe, enjoyable, and reasonable use of such property and to protect and preserve natural ecosystems for the benefit of all citizens of the city.</p>	<p>Require the contractor to obtain a Parkland Access Permit prior to accessing the project area.</p>
Provincial	
<p>Environmental Protection and Enhancement Act R.S.A. 2000, c. E-12 This Act regulates activities with potential for environmental contamination.</p>	<p>Require contractor to develop an Environmental Construction Operations (ECO) Plan that addresses erosion and sediment controls and spill prevention and response. Require contractor to perform weekly environmental monitoring to ensure that project activities are not resulting in sedimentation or contamination.</p>

Legislation	Recommendations and General Practices for Compliance
<p>Soil Conservation Act R.S.A. 2000, c. S-15 This Act imposes a duty upon every landholder to take appropriate measures to prevent soil loss or deterioration, or to mitigate the same where it has occurred.</p>	<p>Incorporate permanent erosion control measures as part of designs.</p> <p>Require contractor to include and Erosion and Sediment Control Plan as part of ECO Plan.</p>
<p>Weed Control Act S.A. 2008, c. W-5.1 This Act regulates the specific weed species that are listed in Schedule 1 (prohibited noxious weeds) and Schedule 2 (noxious weeds) of the Act.</p>	<p>Incorporate measures to prevent the introduction and spread of weed species in the ECO Plan. Ensure equipment arrives on site in clean condition. Use seed mixes that have been certified free of noxious and prohibited noxious weeds for any revegetation activities. Destroy any prohibited noxious weeds and control noxious weeds in project area.</p>
<p>Wildlife Act R.S.A. 2000, c. W-10 Wilful molestation, disruption, or destruction of wildlife, or a house, nest, or den of wildlife, is prohibited under this Act.</p>	<p>Conduct vegetation clearing activities outside of migratory and non-migratory bird nesting periods (mid February to late August). Consult with a qualified professional if vegetation clearing activities must be completed within this nesting period. Follow appropriate mitigation strategies to prevent/minimize potential human-wildlife interactions during construction activities, such as removing wastes from site. If an active nest, den or animal residence is discovered within the project area, stop work and consult a qualified professional.</p>
<p>Federal</p>	
<p>Migratory Birds Convention Act S.C. 1994, c. 22 This Act protects migratory birds, their eggs, and their active nests.</p>	<p>Conduct vegetation clearing activities outside of migratory bird nesting period (mid-April to late-August). Consult with a qualified professional if vegetation clearing activities must be completed within migratory bird nesting period. A pre-construction bird nest sweep should be conducted by a qualified professional with a valid permit prior to any vegetation clearing activities within the migratory bird nesting period. Recommendations by the qualified professional should be followed.</p>
<p>Species at Risk Act S.C. 2002, c. 29 This Act regulates activities with potential to impact species at risk/of concern and/or their habitat.</p>	<p>If a species at risk is encountered during project construction, work should be stopped, and the sighting should be reported and discussed with a qualified professional and/or federal representatives from the Canadian Wildlife Service.</p>

6 PROJECT IMPACTS AND MITIGATION MEASURES

6.1 Environmental Impacts

6.1.1 Geology, Geomorphology, and Soils

All three replacement options have potential impacts on the local geology and soils. The potential project impacts on geology and soils are presented in **Table 6-1**.

Table 6-1
Project Impacts on Geology, Geomorphology, and Soils

Ecosystem Component	Direction and Description of Impact	Characteristics of Impact Before Mitigation Measures
Geology – Steep and unstable slopes in the Ramsey Ravine including the active landslide area.	Negative – Slope failure from heavy equipment operating on the top of the slopes during construction and/or the improper design and installation of replacement infrastructure resulting in slope failure during operation of the replacement bridge.	Nature: Direct Magnitude: High Spatial Extent: Local Duration: Long-term Likelihood: High
Soils – Areas of native soil in Ramsey Ravine.	Negative – Removal and replacement of native topsoil with non-native fill.	Nature: Direct Magnitude: Moderate Spatial Extent: Local Duration: Long-term Likelihood: Moderate
Soils – Areas of native soil in Ramsey Ravine.	Negative – Contamination of soil from spills of construction materials or equipment leaks.	Nature: Direct Magnitude: Moderate Spatial Extent: Local Duration: Long-term Likelihood: Moderate
Soils – Exposed soils during construction phase, especially during unfrozen conditions.	Negative – Erosion of exposed soil resulting in loss of material.	Nature: Direct Magnitude: Low Spatial Extent: Local Duration: Long-term Likelihood: High
Soils – Soils with existing salinity impacts from historical and current use of road salts.	Negative – Transfer of soils with high salinity to locations outside of the project area resulting in salinity impacts to soil and water.	Nature: Indirect Magnitude: Low Spatial Extent: Regional Duration: Long-term Likelihood: Moderate

6.1.2 Groundwater, Surface Water, and Fish Habitat

All three replacement options have potential impacts on surface water and fish habitat. However, potential project impacts to fish habitat are indirect as there is potential fish habitat in the downstream reaches of the unnamed watercourse, which is a tributary to the North Saskatchewan River. The three-span haunched concrete slab and modern concrete arch bridge replacement options require deeper excavations that may impact groundwater during

the construction phase. The potential project impacts on groundwater, surface water, and fish habitat are presented in **Table 6-2**.

Table 6-2
Project Impacts on Groundwater, Surface Water, and Fish Habitat

Ecosystem Component	Direction and Description of Impact	Characteristics of Impact Before Mitigation Measures
Groundwater – Exposed groundwater from construction excavation.	Negative – Excess withdrawal of groundwater from construction dewatering activities.	Nature: Direct Magnitude: Low Spatial Extent: Local Duration: Long-term Likelihood: Low
Groundwater – Exposed groundwater from construction excavations.	Negative – Contamination of groundwater within excavations from construction materials.	Nature: Direct Magnitude: Low Spatial Extent: Local Duration: Long-term Likelihood: Low
Surface Water – Stormwater runoff into the Ramsey Ravine from the bridge deck and roadway approaches.	Positive – Upgrades to grading and catch basins for adequate stormwater drainage and prevention of direct stormwater runoff into the Ramsey Ravine.	Nature: Indirect Magnitude: Moderate Spatial Extent: Local Duration: Long-term Likelihood: High
Surface Water – Unnamed watercourse beneath Wellington Bridge.	Negative – Erosion of unnamed watercourse due to increased water flow and/or velocity during construction and/or operation phases.	Nature: Indirect Magnitude: Moderate Spatial Extent: Local Duration: Long-term Likelihood: Moderate
Surface Water – Unnamed watercourse beneath Wellington Bridge.	Negative – Sedimentation of unnamed watercourse from erosion of bare soil during construction and/or operation phases and from inadequate water flow through the existing culvert beneath the bridge.	Nature: Indirect Magnitude: Moderate Spatial Extent: Local Duration: Long-term Likelihood: Moderate
Surface Water and Fish Habitat – Unnamed watercourse beneath Wellington Bridge with potential fish habitat in downstream reach and at the confluence with North Saskatchewan River.	Negative – Contamination of surface water in unnamed watercourse at and downstream of project area from spills of construction materials or equipment leaks.	Nature: Direct Magnitude: Low Spatial Extent: Regional Duration: Short-term Likelihood: Moderate

6.1.3 Vegetation

All three bridge replacement options have potential impacts on vegetation. The potential project impacts on vegetation are presented in [Table 6-3](#).

**Table 6-3
Project Impacts on Vegetation**

Ecosystem Component	Direction and Description of Impact	Characteristics of Impact Before Mitigation Measures
Vegetation – Native plants in Ramsey Ravine.	Negative – Temporary and permanent loss of native plants and vegetation structure in project area from removal of vegetation to support construction and widening of the replacement bridge.	Nature: Direct Magnitude: Low Spatial Extent: Local Duration: Long-term Likelihood: Certain
Vegetation – Landscape trees and maintained grass in project area.	Negative – Damage to landscape trees and maintained grass in or immediately adjacent to project area from construction activities.	Nature: Direct Magnitude: Low Spatial Extent: Local Duration: Long-term Likelihood: Moderate
Vegetation – Existing populations of weeds and non-native plants.	Negative – Spread of weed populations and non-native plants in project area.	Nature: Direct Magnitude: Low Spatial Extent: Local Duration: Long-term Likelihood: Moderate

6.1.4 Wildlife

All three replacement options have potential impacts on wildlife. The potential project impacts on wildlife are presented in [Table 6-4](#).

**Table 6-4
Project Impacts on Wildlife**

Ecosystem Component	Direction and Description of Impact	Characteristics of Impact Before Mitigation Measures
Wildlife – Active bat roosting in existing bridge structure.	Negative – Removal of maternity roosting habitat, which includes critical habitat for the small-bodied bat species, from the demolition of Wellington Bridge and potential lack of suitable habitat in the new structure.	Nature: Direct Magnitude: High Spatial Extent: Local Duration: Long-term Likelihood: Certain
Wildlife – Bird nesting on existing bridge infrastructure and in vegetation within the project area.	Negative – Temporary or permanent loss of bird nesting habitat from the demolition of Wellington Bridge and	Nature: Direct Magnitude: Low Spatial Extent: Local Duration: Long-term

Ecosystem Component	Direction and Description of Impact	Characteristics of Impact Before Mitigation Measures
Wildlife – Wildlife passage through Ramsey Ravine.	removal of vegetation for construction and operation. Negative – Restriction of wildlife movement between habitats to the north and south of Wellington Bridge from barricades and sensory disturbances during construction and installation of infrastructure for operation of replacement bridge.	Likelihood: High Nature: Direct Magnitude: Low Spatial Extent: Regional Duration: Long-term Likelihood: Low
Wildlife – Sensory perceptions of individuals using habitats near the bridge.	Negative – Interference of hearing or sight from construction or traffic noise or use of artificial lighting in project area during construction or on top of bridge deck during operation.	Nature: Direct Magnitude: Low Spatial Extent: Local Duration: Long-term Likelihood: Low

6.1.5 Historical Resources

All three replacement options have potential impacts on historical resources. The potential project impacts on historical resources are presented in [Table 6-5](#).

**Table 6-5
Project Impacts on Historical Resources**

Ecosystem Component	Direction and Description of Impact	Characteristics of Impact Before Mitigation Measures
Historical Resources – potentially undiscovered archaeological, palaeontological, and/or provincially designated historic Resources and/or Aboriginal traditional use sites within or adjacent to project area.	Negative – Disturbance of unanticipated historic resource through construction activities.	Nature: Direct Magnitude: Unknown Spatial Extent: Local Duration: Short-term Likelihood: Low
Historical Resources – municipal historic status and local importance of Wellington Bridge.	Negative – Replacement of historic and locally valued bridge with new structure.	Nature: Direct Magnitude: High Spatial Extent: Local Duration: Long-term Likelihood: High

6.2 Cumulative Impacts

Minimal cumulative impacts are anticipated as part of the project. There will be a small increase in the discharge from the new bridge due to a widening of the bridge deck; however, this is considered inconsequential to the overall drainage through the stormwater system. The project will have some localized positive impacts on the slope stability and erosion issues within the project area; however, the scope of the project does not include addressing the global stability and erosion concerns that are apparent in the Ramsey Ravine apart from areas that have a direct impact on the integrity of the bridge structure.

6.3 Mitigation Measures

Many of the potential environmental impacts can be mitigated by reducing the footprint of the project and minimizing the duration of construction. Therefore, opportunities for mitigating environmental impacts by minimizing the permanent infrastructure footprint and extent and duration of construction should be considered throughout detailed design and construction. Avoiding the removal of deep-rooted, woody vegetation, as much as possible, should be a focus of the project as this mitigation measure promotes slope stability, erosion protection, native plant habitat, and wildlife habitat.

Given the nature of the geology and soils in the project area and the potential environmental impacts related to these environmental components, it is especially important to maintain engagement and consultation with the project's Geotechnical Consultant, Thurber Engineering Ltd. Recommendations from the geotechnical investigation report prepared by Thurber Engineering Ltd. (2021) are to be reviewed and incorporated, as applicable, into both the detailed design and construction phases of the project ([Appendix A](#)).

Wildlife passage considerations for all three bridge replacement options were included in preliminary design with the recommendation to incorporate wildlife passage beneath the replacement bridge with an openness ratio greater than 1.5. Openness ratio calculations were performed following the same modified method used for calculating the openness ratio for passages beneath the existing bridge. The entire area beneath the proposed deck of the single-span steel girder bridge is a single open space with a cross-sectional area of 256 m². Given that the width of the proposed bridge deck is approximately 24 m, the openness ratio for the single-span steel girder bridge is calculated to be 10.7. With the piers beneath the proposed bridge deck, there are three separate passages that wildlife may use for crossing beneath the three-span concrete slab bridge option. The central open space between the two piers has a cross-sectional area of 251 m² and corresponding openness ratio of 10.5 whereas the two open spaces between the piers and abutments have cross-sectional areas of 91 m² and an openness ratio of 3.8. There will be three open spaces for wildlife passage beneath the modern concrete arch bridge option, including two similar sized spaces adjacent to the abutments as well as the central space below the main arch span. The two open spaces adjacent to the abutments have the same cross-sectional area of 19 m², leading to an openness ratio of 0.8 for each opening. The central open space between the two arch piers has a cross-sectional area of 212 m² leading to an openness ratio of 8.8. It is important to consider that these spaces are not enclosed tunnels, which is the basis for calculating openness ratio. Instead, there are large gaps that will permit light into the open spaces beneath the modern concrete arch bridge option and allow wildlife more visibility than a fully enclosed space. Therefore, regardless of the replacement option selected, the openness ratios will remain greater than 1.5 and the openness beneath the new bridge will not limit the frequent passage of small mammals and birds as well as the occasional passage of large mammals.

There is insufficient information at this phase of the project to provide definitive mitigation measures for the certain impacts on the maternal bat roosting colony through the demolition of the bridge. It is recommended that a regional Wildlife Biologist from Alberta Environment and Parks be engaged about the maternity bat roost and project impacts

to support the development of mitigation measures for bats. It is also recommended that the project positively identifies which bat species are using the bridge structure. Identification methods may include but are not limited to genetic testing from collected carcasses or fecal samples, or mist netting. Identification of bat species, specifically small-bodied species, through acoustic auto-identification is not recommended due to the low accuracy of this methodology. Both short-term and long-term mitigations are required for the project as there will be loss of habitat for maternity roosting bats once the bridge is demolished and long-term roosting habitat is needed for the continued survival of the bat colony. Installation of free-standing bat boxes is recommended as the short-term mitigation measure to support roosting of the maternity bat colony near Wellington Bridge during the demolition and construction phase of the project. Depending on the timing of bridge demolition, a site inspection by a qualified environmental professional and the implementation of exclusion measures may be required (Table 6-6). Various long-term mitigation measures are possible, but all need to be paired with the short-term mitigation measure of using temporary bat boxes. Long-term mitigation measures for maternity bat roosting habitat, listed in order of preference, are:

- incorporating gaps or crevices into the replacement bridge design that are sufficient for providing habitat for maternity bat roosting;
- installing slab boxes beneath the deck of the replacement bridge;
- installing bat condos in the Ramsey Ravine, near to the replacement bridge; and
- installing free-standing bat boxes in the Ramsey Ravine, near to the replacement bridge.

The use of bat condos or free-standing bat boxes as long-term mitigation will require additional vegetation removal as these structures would need to be installed in the Ramsey Ravine with open areas for sun exposure around them. Adequate sun exposure is required so that bats in the maternity colony can maintain sufficient thermoregulation. The long-term mitigation measure to support the continued presence of maternity roosting habitat for bats needs to be incorporated into the detailed design phase of the project.

Prior to the start of construction, the contractor will be required to develop an ECO Plan that is specific to the project. This ECO Plan is to be reviewed and accepted by Associated Engineering Alberta Ltd., as the City of Edmonton's representative, prior to the commencement of construction activities. The contractor's ECO Plan is to be developed in accordance with the most recent version of the ECO Plan Framework prepared by the City of Calgary and City of Edmonton (2020). In addition, the contractor is to include an Erosion and Sediment Control (ESC) Plan, that follows the City of Edmonton Erosion and Sediment Control Guidelines (City of Edmonton 2005) and is endorsed by a Certified Professional Erosion and Sediment Control (CPESC) specialist, into the ECO Plan.

Specific mitigation measures addressing the anticipated or potential environmental impacts identified previously are outlined in Table 6-6.

**Table 6-6
Summary of Mitigation Measures to Address Environmental Impacts of Project**

Ecosystem Component	Environmental Impact	Mitigation Measures for Planning and Design Phase	Mitigation Measures for Construction Phase
Geology – Steep and unstable slopes in the Ramsey Ravine including the active landslide area.	Slope failure from heavy equipment operating on the top of the slopes during construction and/or the improper design and installation of replacement infrastructure resulting in slope failure during operation of the replacement bridge.	<ul style="list-style-type: none"> • Incorporate recommendations from the geotechnical investigation (Thurber Engineering Ltd. 2021) into detailed design. • Maintain participation of Thurber Engineering Ltd. throughout design and construction phase as Geotechnical Consultant for the project. • Include native woody plant species with deep binding roots in restoration plan. 	<ul style="list-style-type: none"> • Follow construction recommendations from the geotechnical investigation (Thurber Engineering Ltd. 2021). • Complete a detailed slope stability assessment of the proposed construction access into the ravine prior to engaging in the work.
Soil – Areas of native soil in Ramsey Ravine.	Removal and replacement of native topsoil with non-native fill.	<ul style="list-style-type: none"> • Include the salvage and storage of native topsoil from the Ramsey Ravine in the restoration plan and avoid the use of non-native fill as much as possible. 	<ul style="list-style-type: none"> • Strip and stockpile native topsoil from the Ramsey Ravine separate from other materials. • Install adequate ESC measures to prevent erosion and loss of native topsoil from stockpile(s).
Soil – Areas of native soil in Ramsey Ravine.	Contamination of soil from spills of construction materials or equipment leaks.	<ul style="list-style-type: none"> • Not applicable. 	<ul style="list-style-type: none"> • Include material storage and handling practices in the project specific ECO Plan with awareness that native soil is an important environmental sensitivity. • Use double-containment for hazardous material storage. • Install drip trays beneath stationary equipment.
Soil – Exposed soils during construction phase, specially	Erosion of exposed soil resulting in loss of material.	<ul style="list-style-type: none"> • Not applicable. 	<ul style="list-style-type: none"> • Minimize the extent and duration of soil exposure, especially during

Ecosystem Component	Environmental Impact	Mitigation Measures for Planning and Design Phase	Mitigation Measures for Construction Phase
during unfrozen conditions.			<p>periods when the ground is not frozen.</p> <ul style="list-style-type: none"> • Include an ESC Plan in the project specific ECO Plan. • Install and maintain appropriate ESC measures throughout construction with attention to areas of exposed soil as well as stockpiled materials.
Soils – Soils with existing salinity impacts from historical and current use of road salts.	Transfer of soils with high salinity to locations outside of the project area resulting in salinity impacts to soil and water.	<ul style="list-style-type: none"> • Include soil and water management specifications in contract documents. 	<ul style="list-style-type: none"> • Replace excavated soil material back into project area. • Dispose excess material in approved landfill.
Groundwater – Exposed groundwater from construction excavation.	Excess withdrawal of groundwater from construction dewatering activities.	<ul style="list-style-type: none"> • Not applicable. 	<ul style="list-style-type: none"> • Inform City of Edmonton and Associated Engineering Alberta Ltd. if construction dewatering is anticipated to be required for greater than 6 months as a Temporary Diversion Licence would be required.
Groundwater – Exposed groundwater from construction excavations.	Contamination of groundwater within excavations from construction materials.	<ul style="list-style-type: none"> • Not applicable. 	<ul style="list-style-type: none"> • Include material storage and handling practices in the project specific ECO Plan with awareness that groundwater in open excavation may be an important environmental sensitivity.
Surface Water – Stormwater runoff into the Ramsey Ravine from the bridge deck and roadway approaches.	Upgrades to grading and catch basins for adequate stormwater drainage and prevention of direct stormwater runoff into the Ramsey Ravine.	<ul style="list-style-type: none"> • Ensure grading and catch basins designs are sufficient for capturing stormwater to prevent runoff directly into the Ramsey Ravine. 	<ul style="list-style-type: none"> • Not applicable.

Ecosystem Component	Environmental Impact	Mitigation Measures for Planning and Design Phase	Mitigation Measures for Construction Phase
Surface Water – Unnamed watercourse beneath Wellington Bridge.	Erosion of unnamed watercourse due to increased water flow and/or velocity during construction and/or operation phases.	<ul style="list-style-type: none"> Consider the volume and rate of stormwater runoff that will be directed into catch basins that outfall into the unnamed watercourse beneath Wellington Bridge and include permanent ESC measures in detailed design, as needed. 	<ul style="list-style-type: none"> Include temporary ESC measures in the project specific ECO Plan to control the volume and/or rate of water runoff from the construction areas into the unnamed watercourse.
Surface Water – Unnamed watercourse beneath Wellington Bridge.	Sedimentation of unnamed watercourse from erosion of bare soil during construction and/or operation phases and from inadequate water flow through existing culvert beneath bridge.	<ul style="list-style-type: none"> Develop restoration plan for vegetated areas temporarily disturbed by construction. Incorporate permanent ESC measures into detailed design. Remove or replace culvert in the unnamed watercourse beneath the bridge. 	<ul style="list-style-type: none"> Minimize the extent and duration of soil exposure, especially during periods when the ground is not frozen. Include an ESC Plan in the project specific ECO Plan. Install and maintain appropriate ESC measures throughout construction with attention to unnamed watercourse at the bottom of the Ramsey Ravine and catch basins on existing bridge approaches.
Surface Water and Fish Habitat – Unnamed watercourse beneath Wellington Bridge with potential fish habitat in downstream reach and at confluence with North Saskatchewan River.	Contamination of surface water in unnamed watercourse at and downstream of project area from spills of construction materials or equipment leaks.	<ul style="list-style-type: none"> Not applicable. 	<ul style="list-style-type: none"> Include material storage and handling practices in the project specific ECO Plan with awareness that surface water in the unnamed watercourse is an important environmental sensitivity. Avoid use of hazardous substances near to unnamed watercourse or existing catch basins. Avoid refuelling or equipment repairs or maintenance near to unnamed watercourse or existing catch basins. Use double-containment for hazardous material storage.

Ecosystem Component	Environmental Impact	Mitigation Measures for Planning and Design Phase	Mitigation Measures for Construction Phase
Vegetation – Native plants in Ramsey Ravine.	Temporary and permanent loss of native plants and vegetation structure in project area from removal of vegetation to support construction and widening of replacement bridge.	<ul style="list-style-type: none"> Minimize extent of infrastructure within the Ramsey Ravine, as much as possible. Coordinate with Natural Areas Operations regarding vegetation removal needed in the Ramsey Ravine to support construction and operation of the project. Develop a restoration plan in detailed design that includes revegetation with native species to restore areas of the Ramsey Ravine that are disturbed through construction. Require contractor to complete a Tree Preservation Plan for the project. 	<ul style="list-style-type: none"> Install drip trays beneath stationary equipment. Perform routine inspection of equipment and construction area to ensure equipment is in good working condition and hazardous materials are contained and stored adequately. Install physical markers to delineate the construction limits and avoid over clearing of vegetation in Ramsey Ravine. Vegetation removal is only to be completed by contractors under the direction of Natural Areas Operations. Complete a Tree Preservation Plan.
Vegetation – Landscape trees and maintained grass in project area.	Damage to landscape trees and maintained grass in or immediately adjacent to project area from construction activities.	<ul style="list-style-type: none"> Include landscaped trees in detailed design and avoid conflicts with these trees. Require contractor to include tree protection for landscaped trees as part of the Tree Preservation Plan. 	<ul style="list-style-type: none"> Include landscaped trees in the project Tree Preservation Plan.
Vegetation – Existing populations of	Spread of weed populations and non-native plants in project area.	<ul style="list-style-type: none"> Not applicable. 	<ul style="list-style-type: none"> Clean equipment prior to arrival on-site and after completion of work before equipment is moved to new location.

Ecosystem Component	Environmental Impact	Mitigation Measures for Planning and Design Phase	Mitigation Measures for Construction Phase
weeds and non-native plants.			<ul style="list-style-type: none"> Control noxious weeds in construction area through mechanical means such as hand pulling.
Wildlife – Active bat roosting in existing bridge structure.	Temporary loss of maternity roosting habitat for bats from the demolition of Wellington Bridge.	<ul style="list-style-type: none"> Construct and install bat boxes in the Ramsey Ravine, near to Wellington Bridge, as many seasons as possible prior to the demolition of the bridge. Plan for bridge demolition to occur between October 1 to March 15 to avoid roosting periods for bats. Retain a qualified environmental professional to conduct a pre-construction inspection of the bridge for bat species prior to demolition. If demolition must occur between March 16 to September 30, bats must be excluded from the bridge structure prior to demolition. Retain a qualified environmental professional to create and execute a bat exclusion plan and monitor bat exclusion activities. Associated will contact Alberta Environment and Parks for additional mitigation requirements pertaining to bats during the detailed design phase of the project. 	<ul style="list-style-type: none"> Exclusion materials must be installed prior to the return of bats in spring (between October 1 to March 16) and may include expanding foam, weather stripping, and/or mesh screens. Regularly inspect exclusion materials, prior to bridge demolition, to ensure materials are functioning as intended and bats are excluded from the bridge structure.
Wildlife – Bird nesting on existing bridge infrastructure and in vegetation within the project area.	Temporary or permanent loss of bird nesting habitat from demolition of Wellington Bridge and removal of vegetation for construction and operation.	<ul style="list-style-type: none"> Plan for removal of vegetation and the temporary falsework system outside of the general bird nesting and early nesting period of mid-February to late-August. Retain a qualified environmental professional to complete a pre-construction nest 	<ul style="list-style-type: none"> Coordinate with Project Managers to ensure that the removal of the temporary falsework system and vegetation is completed prior to construction activities. Install physical markers to delineate the construction limits and avoid

Ecosystem Component	Environmental Impact	Mitigation Measures for Planning and Design Phase	Mitigation Measures for Construction Phase
		<p>sweep of vegetation and temporary falsework system prior to removal if activities occur between mid February and end of August.</p> <ul style="list-style-type: none"> • Coordinate with Natural Areas Operations for vegetation removal in the Ramsey Ravine. For vegetation removal within the general bird nesting period of mid-April to late-August, a pre-construction nest sweep is to be completed. • Develop a restoration plan in detailed design that includes revegetation with native species to restore areas of the Ramsey Ravine that are disturbed through construction. 	<p>over clearing into potential bird nesting habitat.</p>
Wildlife – Wildlife passage through Ramsey Ravine.	Restriction of wildlife movement between habitats to the north and south of Wellington Bridge from barricades and sensory disturbances during construction and installation of infrastructure for operation of replacement bridge.	<ul style="list-style-type: none"> • Design wildlife passage with an openness ratio greater than 1.5 to accommodate movement of wildlife up to large terrestrial mammals, if needed. • Avoid obstructions, including use of rip rap, in designed wildlife passage space. • Develop a restoration plan in detailed design that includes revegetation of habitats within the Ramsey Ravine that are temporarily disturbed through construction. 	<ul style="list-style-type: none"> • Leave gaps in construction area for passage of medium to large mammals travelling parallel through the Ramsey Ravine.
Wildlife – Sensory perceptions of individuals using habitats near to the bridge.	Interference of hearing or sight from construction or traffic noise or use of artificial lighting in project area during construction or on top of bridge deck during operation.	<ul style="list-style-type: none"> • Include lights with low lumen output and dim the luminaire output, as needed. Note that current lights are to be 34 W luminaires dimmed to 31% of their output. 	<ul style="list-style-type: none"> • Limit construction activity to a timeframe between 7 a.m. and 9 p.m. • Direct any construction lighting in towards construction area and avoid

Ecosystem Component	Environmental Impact	Mitigation Measures for Planning and Design Phase	Mitigation Measures for Construction Phase
<p>Historical Resources – potentially undiscovered archaeological, palaeontological, and/or provincially designated historic Resources and/or Aboriginal traditional use sites within or adjacent to project area.</p>	<p>Disturbance of unanticipated historic resource through construction activities.</p>	<ul style="list-style-type: none"> • Design lights with a type IV light distribution to minimize potential light spilling into the Ramsey Ravine. • Submit for a new <i>Historical Resources Act</i> application if footprint changes during detailed design. 	<p>the project of light out into the Ramsey Ravine.</p> <ul style="list-style-type: none"> • Stop work and inform Project Managers of potential discoveries of potential historical resources. • Report discovery of historical resources to Alberta Culture, Multiculturalism and Status of Women.
<p>Historical Resources – municipal historic status and local importance of Wellington Bridge.</p>	<p>Replacement of historic and locally valued bridge with new structure.</p>	<ul style="list-style-type: none"> • Incorporate historical elements into detailed design of replacement bridge. 	<ul style="list-style-type: none"> • Not applicable.

7 ENVIRONMENTAL MONITORING

7.1 Construction

Routine environmental site inspections (e.g., weekly), as well as environmental site inspections after storm events should be completed by the contractor throughout the construction phase to confirm project compliance and that activities are following the ECO Plan. Items addressed through these routine inspections should include but not be limited to project boundary markers and/or fencing, ESC devices, tree protection measures, and material and equipment storage and containment.

If native topsoil is to be salvaged and stored for reclamation, it is recommended that an environmental monitor is present on-site for the start of topsoil stripping work. It is anticipated that vegetation clearing in the Ramsey Ravine will be coordinated and completed through Natural Areas Operations and that it will be preceded by a pre-construction nest sweep if it occurs within the general bird nesting window from mid-April to late-August. In addition, it is recommended that an environmental monitor is present on-site to inspect plant material upon arrival and oversee the initiation of restoration work.

If freestanding bat boxes are used to provide alternative roosting habitat during bridge demolition activities, they should be installed for as many seasons as possible before the demolition of the bridge. Installation of bat boxes prior to construction will increase the likelihood bats will use the boxes during or following construction activities. Bat boxes should be retained for a few years following construction to provide alternative habitat while bats become accustomed to the new bridge structure. Selection of bat box type, placement, and monitoring should be completed by a qualified environmental professional and approved by Alberta Environment and Parks.

7.2 Post Construction

The contractor shall adhere to any monitoring requirements in the contract to ensure that final acceptance criteria are met. It is recommended that an Environmental representative from the Project Team conducts an inspection of the project area during the first growing season after restoration is complete to identify any potential environmental concerns that may need to be addressed.

If bat boxes (including slab boxes and condos) are used as a permanent replacement of roosting habitat after bridge demolition, they should be installed for as many seasons as possible prior to the demolition of the bridge. Selection of bat box type, placement, and monitoring should be completed by a qualified environmental professional and approved by Alberta Environment and Parks. Although bat boxes can provide quality habitat for a long period of time, they will require regular maintenance to ensure suitable habitat remains long-term. Regular maintenance should occur when bats are not present and will address leaks, structural defects, and remove debris that may obstruct access (i.e. vegetation, wasp nests). In addition, the use of freestanding bat boxes or condos as permanent habitat replacement requires tree removals in the Ramsey Ravine to support adequate thermoregulation for the bats using the boxes.

8 PUBLIC, INDIGENOUS, AND STAKEHOLDER ENGAGEMENT

Information in Section 8 of this report is directly from the Wellington Bridge (B003) Preliminary Design Report that was prepared for the City of Edmonton by Associated and submitted in May 2021 (Associated Engineering Alberta Ltd. 2021).

A Stakeholder and Public Engagement Summary Report has been prepared for the Preliminary Design Phase and is provided in [Appendix E](#). The following outlines a brief summary of the Summary Report.

8.1 Background and Engagement Approach

A PECP was prepared at the beginning of the project and reflected the decision mapping developed by the City of Edmonton for the Request for Proposal. Information sharing is the focus of the plan as most decisions were identified as being technical in nature. Some stakeholder engagement related to gathering local knowledge and preferred bridge experience will occur. The PECP is provided in [Appendix D](#).

The Wellington Bridge Replacement webpage (www.edmonton.ca/wellingtonbridge) has been created and will continue to be updated as the project progresses and updates to the public are required.

The identified stakeholders, comprised of several groups/organizations, have a vested interest in the project (e.g., historic importance, design, pedestrian and cycle access, vehicular traffic, and construction impact). There were several internal and external stakeholders identified.

8.1.1 Internal Stakeholders

- Edmonton Historical Board**
- Alberta Historic Resources Branch
- COE Heritage Resources*
- Edmonton Arts Council (EAC)*
- West Valley LRT Project Team
- Neighbourhood Renewal*
- Urban Form and Corporate Strategic Planning*

Internal stakeholders were approached by the City of Edmonton project manager and meetings were set up as required. The stakeholders met with are marked with an asterisk (*) in the list above. Stakeholders who provided information without a meeting are marked with a double asterisk (**). Meeting summaries are provided in [Appendix E](#). Records of correspondence and contacts are maintained.

The internal stakeholders were advised about the project intent, timeline and potential outcomes. Knowledge and perspectives about the impacted communities and past projects were sought from the City departments. The EAC was approached to gain an understanding of their process and timelines.

8.1.2 External Stakeholders

- Glenora Community League
- Grosvenor Community League
- Oliver Community League

- Old Glenora Conservation Association*
- Schools: Progressive Academy, St. Vincent Catholic School, Westminster School, Glenora School
- Paths for People*
- Bike Edmonton*
- Edmonton River Valley Conservation Coalition (EVRCC)
- 124 Street Business Association*

An introductory letter via email about the project was sent out to external stakeholders (with the exception of the schools and the EVRCC) on December 18, 2020. The EVRCC was added as a stakeholder in March 2021 and the introductory letter was emailed. One-on-one meetings were arranged with the groups who indicated an interest after receiving the introductory project letter (marked with an asterisk (*) in the list above). Meeting summaries are provided in [Appendix E](#).

All were advised about the project intent, timeline and potential outcomes in the introductory letter. This information was reiterated in the requested one-on-one virtual meeting held to meet COVID 19 requirements. In addition, their local perspective was collected to help the project team understand opportunities and issues with regard to use, experience, aesthetics, and perceived construction issues.

Lines of communication were set up to meet stakeholder needs, keep them updated and position them to provide their perspective when required. Some external stakeholders (such as the schools and community leagues) may act as a conduit for project information to a larger group within the community in the future through the inclusion of project information on their webpages and/or newsletters as the project progresses.

8.2 What We Have Heard So Far

8.2.1 Internal Stakeholders

Urban Form and Corporate Strategic Planning Meeting – August 28, 2020

- Intent: identify and gain knowledge about internal and external stakeholders who will have an interest in the historic/aesthetic aspects of the Wellington Bridge. Stakeholders identified:
 - Heritage Resources
 - Edmonton Historical Board
 - Old Glenora Conservation Association
 - Edmonton Arts Council
- EAC process was outlined.

Historic Resources and Policy Development Meeting – August 31, 2020

- Intent: identify and gain knowledge about internal and external stakeholders who will have an interest in the historic aspects of the bridge.
- The Old Glenora Conservation Association was identified as a group that has high influence and will have significant interest, in particular to the historic character of the bridge.

Neighbourhood Renewal/Building Great Neighbourhoods (BGN) Meeting – September 3, 2020

- Intent: gain an understanding of external stakeholders with a community connection/interest in the Wellington Bridge.

- The Glenora community went through a Neighbourhood Renewal in +/-2012.
- Glenora community was identified as a highly vested and influential community that has political connections.
- BGN offered lessons learned from Neighbourhood Renewal and suggestions for engagement.

Edmonton Arts Council (EAC) Meeting – November 9, 2020

- Intent: gain an understanding of the EAC process and potential for art within the Wellington Bridge Replacement Project.
- EAC is interested in pursuing public art for this project.
- EAC is unclear as to how funds for public art are calculated and growth vs. renewal delineation.
- Takeaway: City of Edmonton to confirm calculation and funds available for public art.

Edmonton Historical Board (EHB) Letter – April 15, 2021

- Letter from EHB to the City of Edmonton encouraged the preservation of character-defining elements, including the supportive concrete arch and decorative concrete railings.

8.2.2 External Stakeholders

Bike Edmonton Meeting – January 21, 2021

- Intent: introduce the project and gather information on cyclists' concerns and needs for safe cycling on and below the bridge.
- Bike Edmonton identified ponding and tight approaches as the main current issues.
- Supportive of bridge replacement.
- Possible detours during construction were suggested.

Old Glenora Conservation Association Meeting – January 26, 2021

- Intent: introduce the project and gather information on local knowledge, bridge use, and user needs.
- Bridge replacement was not supported. Main concerns:
 - Bridge retention and rehabilitation are considered important for aesthetic and historical perspectives.
 - If replacement is required, it should be rebuilt with a high level of aesthetics.
 - Previous studies (e.g. Condition Assessment Report) were requested.

Paths for People Meeting – January 29, 2021

- Intent: introduce the project and gather information on local knowledge, bridge use, and user needs.
- Supportive of bridge replacement, given that current pedestrian experience on the bridge is poor.
- Wider pedestrian paths and better approaches were emphasized.
- Considerations for improvements to the trail below were also provided.

124 Street Business Association Meeting – February 12, 2021

- Intent: introduce the project and gather information on local knowledge, bridge use, and user needs.
- City indicated that they want to work with the BA in engaging with their members.
- BA indicated this was too early to engage with the business stakeholders due to the extended timeline prior to construction and current need to focus on the Valley Line LRT construction.
- Concerns originating from the 102 Avenue over Groat Road Bridge closure were also identified.

8.3 Next Steps

There are two key considerations for the next stages of engagement:

- Information sharing with businesses: ensure that the High Street businesses are informed about this project in the near future, as they will be impacted by construction.
- Online information sharing event: online information sharing event is planned once a preferred replacement strategy has been identified. An unaddressed mailout, road signs and webpage update will be undertaken to inform the public and stakeholders about the event.

9 CONCLUSION

Wellington Bridge was constructed in 1932 and needs replacement. Associated Engineering Alberta Ltd. included three replacement options for full preliminary design including a single-span steel plate girder bridge, a three-span haunched concrete slab bridge, and a modern single-span concrete arch and ultimately recommend that the City advances the modern arch bridge to detailed design.

Major environmental sensitivities within the project area include steep slopes with landslide areas, an unnamed watercourse, vegetation in the Ramsey Ravine, bird nesting habitat, and a bat colony maternity roost within the existing bridge. All three replacement options will have impacts on these environmental sensitivities that require mitigation measures during the planning and design and construction phases of the project.

Mitigation measures relevant to planning and detailed design include:

- Follow applicable recommendations made by Thurber Engineering Ltd. (2001) and coordinate with Thurber Engineering Ltd. through detailed design of selected replacement option.
- Obtain an Alberta Land Surveyor to survey for potential bed and shore within unnamed watercourse and obtain relevant permits under the *Public Lands Act*, as required.
- Minimize footprint in the Ramsey Ravine required for project infrastructure and construction.
- Coordinate vegetation removal requirements with Natural Areas Operations.
- Develop a restoration plan for areas of the Ramsey Ravine that are temporarily disturbed through construction and include the use of native topsoil, if possible, and deep-rooting, native woody plant species.
- Target removal of vegetation and temporary falsework system and demolition of Wellington Bridge outside of the general nesting period from mid-April to late-August and ensure that pre-construction nest sweeps are completed by qualified professionals if these activities must occur within the general nesting period.
- Plan for bridge demolition to occur between October 1 to March 15 to avoid roosting periods for bats and retain a qualified environmental professional to conduct a pre-construction inspection of the bridge for bat species prior to demolition. If demolition must occur between March 16 to September 30, bats must be excluded from the bridge structure prior to demolition. Retain a qualified environmental professional to create and execute a bat exclusion plan and monitor bat exclusion activities.
- Coordinate with Alberta Environment and Parks on short and long-term mitigation measures for bat colony maternity roosting habitat and install temporary and or permanent roosting structures as far in advance of bridge demolition as possible.
- Submit for a new *Historical Resources Act* application if footprint changes during detailed design and incorporate historical elements into detailed design of replacement bridge.

During the construction phase, the contractor will be responsible for adhering to general construction mitigation measures. These mitigation measures will be outlined in a project-specific ECO Plan that is accepted by the City of Edmonton and Associated Engineering Alberta Ltd. as the City's representative. As part of the ECO Plan the contractor shall be required to develop an ESC Plan that is endorsed by a CPESC. In addition, the contractor is required to develop a Tree Preservation Plan following the City's requirements. The contractor is responsible for routine environmental inspections and maintenance throughout the construction phase of the project.

Overall, the replacement of Wellington Bridge with any of the three replacement options is achievable with minimal environmental impacts for most of the environmental sensitivities given that mitigation measures are followed. However, the long-term residual impacts to bats are unknown due to the nature of their ecology, it is anticipated that impacts will range from minimal to high depending on the timing of construction, the mitigation measures implemented, habitat availability at the time of construction and the habitat selection of individuals.

The City's Planning and Environment Services issued a sign-off letter pertaining to this Environmental Impact Assessment report on December 1, 2021 ([Appendix F](#)). Comments and conditions from this sign-off letter are to be incorporated into the planning, design, and construction phases of this project, as applicable.

CLOSURE

This report was prepared for the City of Edmonton to support the City Planning Department's environmental review process to satisfy the requirements of Bylaw 7188.

The services provided by Associated Engineering Alberta Ltd. in the preparation of this report were conducted in a manner consistent with the level of skill ordinarily exercised by members of the profession currently practicing under similar conditions. No other warranty expressed or implied is made.

Respectfully submitted,

Prepared by:



Brett Bodeux, M.Sc., P.Biol.
Environmental Scientist

Reviewed by:



Sandra Meidinger, P.Biol, R.P. Bio.
Division Manager

BB

REFERENCES

- Alberta Agriculture and Forestry. 2020. Agricultural Region Soil Inventory Database (AGRASID) – Alberta Soil Information Database. Accessed online at: <https://soil.agric.gov.ab.ca/agrasidviewer/>.
- Alberta Environment. 1988. Help End Landfill Pollution – Data Tracking & Management Control System.
- Alberta Environment. 2001. Guide to the Code of Practice for Watercourse Crossings, Including Guidelines for Complying with the Code of Practice. Accessed online April 12, 2021 at: <https://open.alberta.ca/dataset/7f60e27f-d9ca-4215-aaae-9adec610974b/resource/f1dfd81c-4bb9-4ff7-a547-4d702870d32c/download/2001-watercoursecrossingsguide-apr2001.pdf>
- Alberta Environment and Parks. 2020. Environmental Site Assessment Repository.
- Alberta Parks. 2019. Alberta Conservation Information Management System (ACIMS). Available online: [http://www.albertaparks.ca/albertaparksca/management-land-use/alberta-conservation-information-management-system-\(acims\)/download-data.aspx#trackedWatch](http://www.albertaparks.ca/albertaparksca/management-land-use/alberta-conservation-information-management-system-(acims)/download-data.aspx#trackedWatch). Accessed February 3, 2021.
- Alberta Fish and Wildlife Division (AFWD). 2010. Handbook of Inventory Methods and Standard Protocols for surveying Bats in Alberta. Prepared by Maarten Vonhof.
- Associated Engineering Ltd. 2021. Preliminary Engineering Report. B003: Wellington Bridge Replacement. Edmonton, Alberta.
- Caceres, M. Carolina and M.J. Pybus. (1997). Status of the Northern Long-eared Bat (*Myotis septentrionalis*) in Alberta. Alberta Environmental Protection, Wildlife Management Division, Wildlife Status Report No. 3, Edmonton, AB. 19pp.
- City of Calgary and City of Edmonton. 2020. Environmental Construction Operations (ECO) Plan Framework Municipal Version Instructions for Preparing ECO Plans for City of Calgary and City of Edmonton Construction Projects. Available online: https://www.edmonton.ca/city_government/environmental_stewardship/environmental-construction-operations-plans.aspx. Accessed August 19, 2021.
- City of Edmonton. 2005. Erosion and Sediment Control Guidelines. Available online: https://www.edmonton.ca/city_government/utilities/erosion-and-sedimentation-control.aspx. Accessed August 19, 2021.
- City of Edmonton. 2015. Urban Primary Land Vegetation Inventory. Available online: <https://data.edmonton.ca/stories/s/uPLVI-Information-Portal/3fsu-hkrk/>. Accessed August 19, 2021.
- City of Edmonton, 2016. Environmental Sensitivity Project, Model data. Prepared for: The City of Edmonton, Alberta. Prepared by: Solstice Canada. Edmonton Alberta.

- City of Edmonton. 2018. North Saskatchewan River Valley Area Redevelopment Plan, Bylaw 7188.
- City of Edmonton. 2019. City of Edmonton Bylaw 18093 Drainage Bylaw. Available online: <https://www.edmonton.ca/documents/Bylaws/C18093.pdf>. Accessed June 2, 2021.
- City of Edmonton. 2020a. Corporate Tree Management Policy C456C. Available online: https://www.edmontcon.ca/residential_neighbourhoods/PDF/Corporate-Tree-Management-Policy-C456C.pdf. Accessed June 2, 2021.
- City of Edmonton. 2020b. City of Edmonton Bylaw 14600 Community Standards Bylaw. Available online: <https://www.edmonton.ca/documents/Bylaws/C14600.pdf>. Accessed June 2, 2021.
- City of Edmonton. 2020c. City of Edmonton Bylaw 18100 EPCOR Drainage Services Bylaw. Available online: <https://www.edmonton.ca/documents/Bylaws/C18100.pdf>. Accessed January 4, 2021.
- Cornell Lab of Ornithology. 2019. All About Birds. Available online: <https://www.allaboutbirds.org/guide/>. Accessed February 3, 2021.
- Fisheries Act*. RSC 1985, c. F-14.
- Government of Alberta. 2015a. Roadway Watercourse Crossing Inspection Manual. Accessed online April 12, 2021 at: <https://open.alberta.ca/dataset/a832eee1-53b4-45f7-a46c-8e81b498080f/resource/d338eb1d-5609-4a3a-bc96-e876442df0c4/download/6799953-2015-roadway-watercourse-crossing-inspection-manual-version-5.2.2.-2015-03-13.pdf>
- Government of Alberta. 2015b. General Status of Alberta Wild Species. Available online at: <https://extranet.gov.ab.ca/env/wild-species-status/>. Accessed February 3, 2021.
- Government of Alberta. 2020a. Alberta Flood Hazard Map Application. Available online: <https://floods.alberta.ca/>. Accessed August 19, 2021.
- Government of Alberta. 2020c. Fisheries and Wildlife Management Information System (FWMIS). Available online at: <https://www.alberta.ca/access-fwmis-data.aspx>. Accessed February 3, 2021.
- Government of Alberta. 2020d. Listing of Historical Resources. Available online: <https://www.alberta.ca/listing-historic-resources.aspx>. Accessed February 3, 2021..
- Government of Canada. 2018. General Nesting Periods of Migratory Birds in Canada. Environment Canada. Available online: <https://www.canada.ca/en/environment-climate-change/services/avoiding-harm-migratory-birds/general-nesting-periods/nesting-periods.html>. Accessed February 3, 2021..
- Government of Canada. 2019. Species at Risk Public Registry: A to Z Species Index. Available online: <https://species-registry.canada.ca/index-en.html#/species?sortBy=commonNameSort&sortDirection=asc&pageSize=10>. Accessed February 3, 2021..
- Historical Resources Act*. RSA 2000, c. H-9.

Kays, R. W., and D. E. Wilson. 2009. *Mammals of North America* Second Edition. Princeton University Press. Princeton, New Jersey.

MacLaren Plansearch Lavalin. 1982. Identification and Verification of Active and Inactive Land Disposal Sites in Alberta. Prepared for Alberta Environment and Environment Canada.

Migratory Birds Convention Act. SC 1994, c. 22.

Pedocan Land Evaluation Ltd. 1993. Soil Series Information for Reclamation Planning in Alberta. Conservation and Reclamation Council Report No. RRTAC 93-7 (2 volumes). ISBN 0-7732-6041-2.

Public Lands Act. RSA 2000, c. P-40.

Soil Conservation Act. RSA 2000, c. S-15.

Species at Risk Act, SC 2002, c. 29.

Stavne, R.B. 2006. Sharp-tailed grouse lek surveys, northwestern Alberta, 2005. Data Report, D-2006-011. Alberta Conservation Association, Peace River, Alberta.

Thurber Engineering Ltd. 2021. Wellington Bridge Replacement – Geotechnical Investigation. Edmonton, Alberta.

Weed Control Act. RSA 2008, c. W-5.1.

Weed Control Regulation. Alberta Reg. 19/2010.

Wildlife Act. RSA 2000, c. W-10.

APPENDIX A – GEOTECHNICAL INVESTIGATION

**WELLINGTON BRIDGE REPLACEMENT
EDMONTON, ALBERTA
GEOTECHNICAL INVESTIGATION**



THURBER ENGINEERING LTD.



THURBER ENGINEERING LTD.

**WELLINGTON BRIDGE REPLACEMENT
EDMONTON, ALBERTA
GEOTECHNICAL INVESTIGATION**

Report

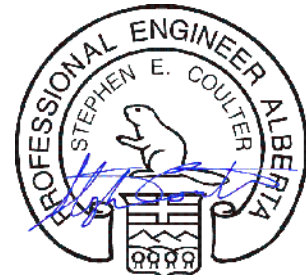
to

Associated Engineering Alberta Ltd.




February 4, 2021

Bruce Nestor, P. Eng.
Geotechnical Engineer

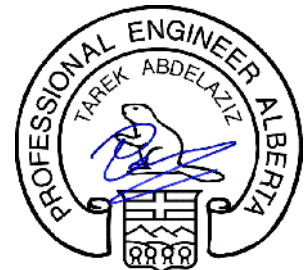


2021-02-04

Stephen Coulter, M.Eng., P. Eng., P.E.
Associate | Senior Geotechnical Engineer

PERMIT TO PRACTICE THURBER ENGINEERING LTD.	
Signature _____	
Date _____	February 4, 2021
PERMIT NUMBER: P 5186	
The Association of Professional Engineers and Geoscientists of Alberta	

Date: February 4, 2021
File: 28874



February 4, 2021

Tarek Abdelaziz, Ph.D., P.Eng.
Principal | Senior Geotechnical Engineer



TABLE OF CONTENTS

1.	INTRODUCTION.....	1
2.	PROJECT DETAILS	1
3.	METHOD OF INVESTIGATION	2
3.1	Site History	2
3.2	Review of Existing Data	2
3.3	Site Reconnaissance.....	4
3.4	Drilling Investigation	5
3.5	Laboratory Testing	6
4.	SURFACE CONDITIONS	8
5.	SUBSURFACE SOIL CONDITIONS.....	9
5.1	Clay (Fill)	9
5.2	Clay (Native).....	9
5.3	Clay Till.....	10
5.4	Sand (Empress Formation)	10
5.5	Bedrock	10
5.6	Bedrock Quality	11
5.7	Groundwater Conditions.....	12
5.8	Frost Penetration	14
6.	GEOTECHNICAL ASSESSMENT AND RECOMMENDATIONS	14
6.1	Bridge Foundations	14
6.1.1	General	14
6.1.2	Axial Capacity of Piles	16
6.1.2.1	Cast-in-Place Concrete Piles.....	16
6.1.2.2	Driven Steel Piles	20
6.1.3	Lateral Capacity of Piles.....	24
6.1.3.1	Modulus of Horizontal Subgrade Reaction	24
6.1.3.2	Group Effect	25
6.1.4	Pile Caps	27
6.1.5	Earth Pressures and Abutment Wall.....	27



6.2	Bridge Headslope Stability	31
6.2.1	General	31
6.2.2	Centreline Headslope	32
6.2.3	North Edge Headslope	35
6.2.4	Additional Considerations	40
6.3	Cement Type	42
6.4	Seismicity	43
7.	FURTHER INVESTIGATION AND DETAILED DESIGN	43
8.	LIMITATION AND USE OF REPORT	43

STATEMENT OF LIMITATIONS AND CONDITIONS

APPENDICES

APPENDIX A

Drawing No. 28874-1 – Site Plan Showing Approximate Test Hole Locations
Drawing No. 28874-2 – Stratigraphic Cross-Section A-A'
Drawing No. 28874-3 – Surficial Geology Map
Preliminary Bridge Design Concepts

APPENDIX B

Selected Site Photographs

APPENDIX C

Modified Unified Soils Classification System
Symbols and Terms Used on the Test Hole Logs
Current Test Hole Logs (TH20-1 to TH20-5)
Previous Test Hole Logs (TH14-1 to TH14-2)

APPENDIX D

Laboratory Test Results



1. INTRODUCTION

This report presents the results of a geotechnical investigation undertaken by Thurber Engineering Ltd. (Thurber) for the proposed replacement of Wellington Bridge, which carries 102 Avenue over the Ramsey Ravine between Wellington and Churchill Crescents in Edmonton, Alberta.

The geotechnical investigation was carried out in general accordance with our proposal to Mr. Michael Paulsen, P.Eng., of Associated Engineering Alberta Ltd. (AEAL), dated May 1, 2020, as well as Scope Change Request No. 1, dated August 27, 2020, and Scope Change Request No. 2, dated September 28, 2020, addressed to Ms. Tara Alexander, P.Eng. of AEAL.

It is a condition of this report that Thurber's performance of its professional services is subject to the attached Statement of Limitations and Conditions.

2. PROJECT DETAILS

It is understood that the Wellington Bridge was constructed in 1932 and is one of the oldest existing bridges within the City of Edmonton. The bridge consists of a three-span, 48 m long arch structure. In 2014, a temporary shoring system was installed beneath the bridge to accommodate the passage of construction equipment and materials for the new 102 Avenue Bridge over Groat Road. The shoring system is still in place and the Wellington Bridge is currently open to vehicle and pedestrian traffic. The location and general layout of the bridge is shown on Drawing No. 28874-1 in Appendix A.

We further understand that the City is exploring three preliminary options to replace the current bridge. These replacement options include:

- A single span steel girder bridge
- A three-span haunched concrete deck slab bridge
- A three-span modern arch bridge.

For the replacement options, AEAL has provided Thurber with three current design concepts featuring different arrangements of foundation elements. These design options are provided in Appendix A. At the time of preparing this report, the preferred option was not selected by the City.

As part of the bridge replacement assessment, Thurber was retained to undertake a geotechnical investigation in order to provide geotechnical recommendations for the design and the construction of the replacement bridge. The following sections present the methodology, results, and recommendations of the investigation.



3. METHOD OF INVESTIGATION

3.1 Site History

Thurber was part of the team that provided geotechnical engineering services to CH2M HILL for the 2013 Bridge Assessment Report and the 2014 Rehabilitation Program and to Dialog for an additional 2020 Bridge Shoring Assessment and has prepared the previous reports pertaining to these works:

- Wellington Bridge Condition Assessment, Preliminary Assessment of Bearing Capacity of Bridge Foundations, September 18, 2013
- Wellington Bridge Rehabilitation Geotechnical Investigation, February 6, 2014
- Wellington Bridge Rehabilitation Geotechnical Investigation, Addendum #1 – Construction Monitoring and Limitations, March 12, 2014
- Wellington Bridge, Geotechnical Assessment of Shoring System and Slope Conditions, April 23, 2020

As previously discussed in prior reports prepared by Thurber, there is a major geotechnical feature that is present at the site and should be considered during design for the future bridge replacement. This feature is a relatively active (creeping) landslide that has been identified on the western ravine slope immediately north of the western bridge abutment. At the time of the preparation of the proposal for this project, it was strongly recommended that this landslide be further studied and evaluated for its effects on both the existing and future bridges. Through this study, the development of additional slope remediation measures may be required. Further discussion of the site conditions is presented below in Section 3.2.

3.2 Review of Existing Data

In addition to the geotechnical reports mentioned above in Section 3.1, Thurber has previously reviewed the following topographical maps, and geological maps to gain an understanding of the overall site conditions:

- Kathol, C.P. and McPherson, R.A. Urban Geology of Edmonton, Bulletin 32, Alberta Research Council, 1975.
- LIDAR Data, Provided by City of Edmonton, 2015-2018.
- Aerial Photograph, Provided by City of Edmonton, 2019.
- Spence Taylor, Richard. Atlas: Coal-Mine Workings of the Edmonton Area, 1971.
- Alberta Energy Regulator. Online Coal Mine Map Viewer, Accessed 2020.

In the vicinity of the bridge, the crest of the ravine is situated at an approximate elevation of 664 m and the bottom of the ravine is situated at an elevation of approximately 651 m. Available published geological mapping indicates that the top of the bedrock surface is at approximately 615 m.



Based on our review of the available geotechnical information, the stratigraphy in the study area consists of glaciolacustrine clay, underlain in sequence by clay till, sand of the Empress Formation, overlying clay shale bedrock of the Edmonton Group. Previous assessments completed by Thurber indicated that the bridge pier foundations may have been founded near the interface of the glaciolacustrine clay and underlying clay till. This appears to be relatively consistent with the sketched cross-section included in the as-built drawings for the existing bridge where the piers are shown to be founded on the top of a “hard” clay layer. Test hole logs for the test holes advanced in 2014 (TH14-1 and TH14-2) are provided in Appendix C for reference.

The surficial geology of the site is presented on Drawing No. 28874-3 in Appendix A. As illustrated, the ravine slopes are dominated by two major colluvium units which consist of weathered and gravitationally moved deposits. At the bottom of the ravine, this colluvium is a mixture of glacial till and glaciolacustrine deposits mixed with some sand, gravel, and cobbles. In the upper portion of the ravine slopes, the colluvium consists primarily of glaciolacustrine deposits that are susceptible to gradual seasonal creep movements along the contact with the glacial till, which coincides with an area of typical groundwater discharge. The plateau area consists primarily of glaciolacustrine deposits at the surface.

A review of the LIDAR and geological mapping has also indicated the presence of some landslide areas along Ramsey Ravine in the vicinity of the bridge. As delineated on Drawing No. 28874-3 there are areas of landslides in the form of slow mudflow due to groundwater discharge to the south of the bridge on both sides of the ravine. North of the bridge are areas of landslides in initial stages of shallow movement caused by seasonal effects.

A third and more noteworthy type of landslide is noted directly north of the bridge on the west side of the ravine. This landslide is in an advanced stage with visible cracks and slide surfaces. Based on data review, this slide appears to be active but moving at a slow rate. This landslide appears to be shallow, and the rate of movement is highly influenced by seasonal effects such as drainage and freeze/thaw cycles. The landslide is about 55 m wide (parallel to Churchill Crescent) and 40 m long (along slope direction). The southern flank of this landslide mass is in the vicinity of the northern edge of the west bridge abutment.

A review of the available coal mine references listed above did not indicate any history of coal mining within the project area. The closest identified coal mine to the site was indicated to be in the Groat Creek Valley to the east of Ramsey Ravine. However, it is possible that smaller scale coal mines could have been advanced in areas not recorded in the available references. If mines are present at the bridge location, additional measures will be required to design the bridge foundations. Although there is risk associated with the presence of smaller scale coal mines, the risk is low considering the past performance of the bridge structure. Additional work to explore this possibility may include drilling additional core holes along with using a suitable geophysical survey method.



3.3 Site Reconnaissance

A field reconnaissance visit was undertaken by Tarek Abdelaziz, P.Eng. and Stephen Coulter P.Eng. on September 4, 2020. The purpose of this site visit was to confirm the results of the data review, observe and assess the current geotechnical site conditions, and assess the location and drill rig access for the test holes.

Selected photographs from the site visit are attached in Appendix B. The major geotechnical aspects observed on site during this visit include the following, notable features are also included on the site plan provided as Drawing No. 28874-1, in Appendix A.

- The existing landslide zone that was identified on the west side of the ravine and north of the existing bridge was visually evident from the surface condition of the slope surface in this area, including hummocky terrain, erosion gullies, and leaning trees.
- Cracks in the pavement were observed along Churchill Crescent at the crest of the ravine slope. The north-south cracks were approximately 10 to 25 mm wide and extended approximately 50 m north of the west abutment area. The cracks were observed to be more severe for the zone immediately 30 m north of the bridge. This area was coincident with the most disturbed areas of the ravine slope. The cracks are located within 2 m of the eastern curb of Churchill Crescent.
- Within the landslide zone the scarp crack at the most distressed area is approximately 1.5 m from the east curb of Churchill Crescent.
- At the toe of the western ravine slope and along the western edge of the multi-use trail there is an existing timber retaining wall that is approximately 1 to 1.5 m in height. North-south cracks are visible on the asphalt surface of the trail between the southern end of the retaining wall and the bridge structure.
- A catch basin was identified along the eastern curb of Churchill Crescent, approximately 15 m north of 102 Avenue. This catch basin appeared to be connected to the outfall located at the bottom of the ravine slope that daylights east of the multi-use trail on the north side of the bridge. In previous discussions with the City, it has been indicated that this catch basin has flooded, and the water has overflowed onto Churchill Crescent and subsequently spilled over the ravine slope in the vicinity of the northwest corner of the existing bridge. Surficial erosion channels were observed along the ravine slope in this area.
- The outfall pipe connected to this catch basin also shows some visual evidence of erosion along its alignment down the western ravine slope, which could be due to leakage of the pipe and subsequent seepage of discharged surface water into the near surface soil.
- Two diagonal open cracks (up to 25 mm in width) were observed on the 102 Avenue asphalt surface behind the west abutment along with a slight dip in the road in the abutment area. In general, the east headslope appears to be more stable than the west headslope.



- An additional smaller erosion channel was observed north of the bridge on the east side of the ravine.
- The east headslope was observed to be relatively flatter than the west headslope.
- There are some signs of disturbance in the drainage channel located to the east of the multi-use trail to the south of the bridge location. These signs include falling and tilting trees and distortion of the gabion structures within the channel. There are several outfalls along the eastern ravine slope that also show adjacent erosion features and the east slope above the disturbed channel appears to be creeping and pushing into the channel.
- In general, the headslopes and ravine slopes are considered to be marginally stable. The stability of the slopes is aided by the root structure of the considerable mature vegetation that is present on them. However, locally steep slopes (2H:1V or steeper) are present in some sections and should be considered sensitive and prone to erosion or oversteepening if disturbed.

3.4 Drilling Investigation

The current investigation included drilling three test holes (TH20-1 to TH20-3) for the bridge structure and two test holes (TH20-4 and TH20-5) for the NW landslide investigation.

The approximate locations of the test holes are shown on Drawing 28874-1, in Appendix A. The test holes were advanced to depths ranging from 10.1 m to 60.2 m.

TH20-1 and TH20-2 were drilled on October 17-19, 2020 and October 13-16, 2020, respectively, using a truck-mounted wet rotary/coring rig owned and operated by Mobile Augers and Research Ltd. of Edmonton, Alberta. A temporary one-lane closure was required to drill TH20-1 for the west bridge abutment due to the location of the borehole within one of the westbound lanes of 102 Avenue.

TH20-3 was drilled from September 16 to 19, 2020, using a track-mounted wet rotary/coring rig owned and operated by All Service Drilling Ltd. (ASD) of Nisku, Alberta. TH20-3 was accessed using an asphalt paved trail starting at Churchill Crescent. A temporary trail closure was put in place in order to complete this borehole. This test hole encountered difficulty penetrating the thick sand layer beneath the clay till and the drilling equipment was unable to penetrate below a depth of approximately 45 m. The hollow stem augers became stuck in the test hole and could not be removed and were eventually cut off below the surface and grouted into place.

TH20-4 and TH20-5 were completed on October 19-20, 2020 using a track-mounted drill rig operated by ASD. A temporary trail closure and full road closure of Churchill Crescent was put in place to complete these two test holes.

All road closures for this project were undertaken under valid ULA and OSCAM permits acquired from the City. Thurber provided temporary traffic control and signage for all on street work.



Prior to drilling, the test hole locations were cleared of underground utilities using the Alberta One Call system and third party private locates provided by National Locators of Edmonton, Alberta.

Retrieved soil samples were logged in the field by Thurber inspectors and then transferred to our Edmonton laboratory for further analysis and testing.

Standard Penetration Tests (SPT's) were carried out at regular depths in the overburden soils overlying the bedrock. Once encountered, the bedrock was cored to retrieve continuous samples. Water and slough levels were noted during and immediately after the completion of the drilling prior to installation of geotechnical instrumentation and backfilling of the holes with grout.

Vibrating wire piezometers were installed at select depths in TH20-1, and TH20-2, while slope inclinometer casing and vibrating wire piezometers were installed in TH20-4 and TH20-5. A flush mount protector was installed at each of the instrumented borehole locations to allow for future monitoring of the instrumentation. The abandonment of the augers in the test hole did not allow for any instrumentation to be installed in TH20-3.

As requested by the City, instrumentation installed in TH20-1 and TH20-2 is to be monitored by Thurber and instrumentation installed in TH20-4 and TH20-5 is to be monitored by the City.

Additional details pertaining to the drilling are noted on the test hole logs in Appendix C.

3.5 Laboratory Testing

Laboratory testing consisted of a visual classification of all grab and core samples as well as moisture content of all grab samples and select core samples. In addition, water-soluble sulphate content, Atterberg limits and unconfined compression tests were also carried out on select soil and bedrock samples.

The results of the drilling program and laboratory testing of the 2020 test holes are summarized on the attached test hole logs (Appendix C) and in Tables 3.1 to 3.4. Laboratory data results are provided in Appendix D.

**TABLE 3.1
SUMMARY OF UNIAXIAL COMPRESSIVE STRENGTH TESTS**

TEST HOLE NO.	DEPTH (m)	BULK UNIT WEIGHT (kN/m ³)	UNDRAINED SHEAR STRENGTH* (kPa)
Clay (Glaciolacustrine)			
TH20-1	3.8 - 4.3	19.1	72.4
Clay Till			
TH20-1	13.0 – 13.4	21.7	320.7
TH20-2	16.0 – 16.5	21.9	268.0
TH20-3	5.3 – 5.8	21.5	148.9
Clay Shale			
TH20-1	48.4 – 48.6	21.5	320.1
TH20-1	52.0 – 52.1	22.0	300.9
TH20-2	55.2 – 55.3	22.0	888.1
TH20-3	36.0 – 36.1	21.1	319.1
TH20-3	40.4 – 40.5	21.9	2797.9
Sandstone			
TH20-2	58.2 – 58.4	22.1	1278.4

*Equal to half the uniaxial compressive strength

**TABLE 3.2
SUMMARY OF ATTERBERG LIMITS TEST**

TEST HOLE NO.	DEPTH (m)	LIQUID LIMIT (%)	PLASTIC LIMIT (%)	USC
Clay (Fill)				
TH20-1	1.5	64	30	CH
TH20-3	1.5	45	22	CI
Clay (Native)				
TH20-1	3.8 – 4.3	55	29	CH
TH20-2	3.8 – 4.3	57	25	CH
TH20-4	3.8 – 4.3	70	29	CH
Clay Till				
TH20-1	13.0 – 13.4	41	19	CI
TH20-2	16.0 – 16.5	42	16	CI
TH20-3	7.6	41	17	CI
TH20-4	13.0 – 13.4	40	17	CI
TH20-5	3.8 – 4.3	36	17	CI



**TABLE 3.3
SUMMARY OF GRAIN SIZE ANALYSIS TESTS**

TEST HOLE NO.	DEPTH (m)	GRAVEL (%)	SAND (%)	SILT + CLAY (%)
TH20-1	27.4	0.2	93.4	6.4
TH20-2	30.5 – 30.6	0.0	83.8	16.2
TH20-3	16.0 – 16.5	0.0	90.7	9.3

**TABLE 3.4
SOLUBLE SUPHATE CONTENT TESTING**

TEST HOLE NO.	DEPTH (m)	SOLUBLE SUPHATE CONTENT (PFRA METHOD)
TH20-1	1.5	0.04 %
TH20-1	3.8 – 4.3	0.00 %
TH20-1	20.6 – 21.0	0.04 %
TH20-2	3.8 – 4.3	0.04 %
TH20-2	16.0 – 16.5	0.02 %
TH20-3	1.5	0.02 %
TH20-3	7.6	0.02 %

4. SURFACE CONDITIONS

The existing bridge structure is oriented in an east-west direction and carries four lanes of 102 Avenue over the Ramsey Ravine. A paved shared-use path, running along the bottom of the ravine, passes beneath the center span of the bridge at the project site. In general, the crest of the Ramsey Ravine is situated at an elevation of 664 m, which roughly corresponds to the elevation of the bridge deck. The bottom of the ravine is situated at an elevation of approximately 651 m. The ravine slopes and the headslopes of the bridge below the abutments are sloped at approximately 3H:1V with some sections approaching 2H:1V. The slopes surrounding the bridge are generally inclined at angles ranging between 17 and 23 degrees.

Thurber’s previous review of the LIDAR and geological mapping of the site indicated the presence of landslide areas along the Ramsey Ravine slopes in the vicinity of the bridge. As shown in Drawing Nos. 28874-1 and 28874-3, there are slow mudflow landslides due to groundwater discharge to the south of the bridge on both sides of the ravine. As previously discussed, to the north of the bridge are shallow moving landslides caused by seasonal effects. There is also a landslide in advanced stage directly north of the bridge on the west side of the ravine. This landslide is approximately 55 m wide (parallel to Churchill Crescent) and 50 m long (along the slope direction) and has resulted in visible cracks in the asphalt along Churchill Crescent. The southern flank of this landslide mass is in the vicinity of the northern edge of the west bridge abutment.



5. SUBSURFACE SOIL CONDITIONS

The generalized soil stratigraphy on both sides of the bridge consists of clay fill, overlying clay, overlying clay till, overlying sand of the Empress Formation, overlying clay shale and sandstone bedrock.

The following sections provide a brief description of the sub-surface conditions encountered in the test holes. Detailed soil/ bedrock information from the field program are provided on the individual test hole log (see Appendix C) which govern in the case of discrepancy. Test hole logs from the 2014 investigation are also included in Appendix C.

The subsurface information was used to develop a stratigraphic cross-sectional profile running along the centreline of the existing bridge in an east-west direction, as shown on Drawing No. 28874-2 in Appendix A. It should be noted that the ground profile has been estimated from the 2015 LiDAR data. Because of the natural variability of the strata, the boundaries between various strata may vary from the interpolated boundaries presented in Drawing No. 28874-2.

5.1 Clay (Fill)

Clay fill was encountered beneath the topsoil or road structure in all of the test holes except TH20-2 and extended to depths ranging from about 0.8 m to 3.4 m below ground surface. The clay fill was generally medium to high plastic, dark brown to black, silty, with some sand and organics. The natural moisture content of the clay fill ranged from 18.5 percent to 41.8 percent. SPT "N" values of the clay ranged from 3 to 6 blows per 300 mm penetration, indicating a soft to firm consistency.

Two Atterberg Limits tests were conducted on samples taken from the clay fill, and yielded Liquid Limits ranging from 45 to 64 percent, and Plastic Limits ranging from 22 to 30 percent, indicating that the clay fill ranged from medium to high plastic.

5.2 Clay (Native)

Native glaciolacustrine clay was encountered in TH20-1, TH20-2 and TH20-4 below the clay fill and extended to depths ranging from 6.1 m to 7.6 m depth. The native clay was generally brown, silty, with trace sand, oxides, rootlets, and silt lenses. The natural moisture content of the native clay ranged from 15.8 percent to 45.8 percent. SPT "N" values of the native clay ranged from seven to 18 blows per 300 mm penetration, indicating a firm to very stiff consistency.

Three Atterberg Limits tests were conducted on selected samples of the native glaciolacustrine clay and indicated Liquid Limits ranging from 55 to 70 percent, with Plastic Limits ranging from 25 to 29 percent, indicating the clay was high plastic.

One uniaxial strength test was conducted on the native clay and yielded an undrained shear strength value of 72.4 kPa, which indicated a stiff consistency.



5.3 Clay Till

Clay till was encountered below the glaciolacustrine clay and extended to depths ranging from about 12.2 m to 25.2 m below ground surface. The clay till was generally medium plastic, brown to dark grey, silty, sandy, and contained trace amounts of gravel, coal, and oxides. The natural moisture content of the clay till ranged from 15.1 to 24.8 percent. SPT “N” values ranged from seven to 105 blows per 300 mm penetration, indicating a firm to very hard consistency. The clay till was generally noted to exhibit higher strength with depth. The clay till near the base of the slopes was generally noted to be weaker than the clay till within the upper sections of the slope.

Sand layers/lenses up to 0.7 m thick were encountered within the clay till in test holes TH20-1, TH20-2, TH20-3, and TH20-4, occurring at depths ranging between 9.9 m to 21.6 m. Seepage was frequently encountered within these inter-till sand layers.

It should be noted, that while not encountered in the test holes, clay till typically contains cobbles and boulders throughout.

Five Atterberg limits tests were undertaken on select samples of clay till, indicating a Liquid Limit ranging from 36 percent to 42 percent and a Plastic Limit ranging from 16 percent and 19 percent, indicating medium plasticity.

Three uniaxial compressive strength tests were conducted on select samples of the clay till and yielded undrained shear strength values of 148.9 kPa to 320.7 kPa, indicating a very stiff to very hard consistency.

5.4 Sand (Empress Formation)

Empress Formation sand was encountered below the clay till in test holes TH20-1, TH20-2, and TH20-3, extending to depths ranging from 34.2 m to 44.8 m below ground surface.

The sand was generally brown to grey, fine to medium grained and contained trace to some silt. The natural moisture content of the sand ranged from 3.5 to 21.3 percent. SPT “N” values were typically greater than 50 blows per 150 mm of penetration, indicating a very dense relative density.

Three grain size analyses were undertaken on select samples of the sand, and yielded gravel content between 0 to 0.2 percent, sand content ranging from 83.8 to 93.4 percent, and a fines content ranging between 6.4 to 16.2 percent.

5.5 Bedrock

Clay shale and sandstone bedrock was encountered below the Empress Formation sand in TH20-1, TH20-2 and TH20-3 at depths ranging from 34.3 m to 44.8 m below ground level and extending to the termination depth of the test holes.

The natural moisture content of the bedrock ranged from 11.3 to 32.4 percent. The bedrock was observed to be extremely weak to weak in rock mechanics terms, which corresponds to a hard to very hard consistency in soil mechanics terms.



Five unconfined compression tests were conducted on select clay shale samples. The tests indicated a uniaxial compressive strength ranging from 600 kPa to 5600 kPa, corresponding to a strength range of extremely weak to weak in rock mechanics terms.

One unconfined compression strength test was conducted on a sample of sandstone from TH20-2. The sample showed a uniaxial compressive strength of 2557 kPa corresponding to a very weak strength in rock mechanics terms.

Coal seams up to 1.1 m thick were encountered in each of the test holes, in addition to bentonite seams up to 0.1 m thick. The bentonite occurred at elevations ranging from 608.9 m in TH20-2 to 618.2 m in TH20-3, corresponding to depths below ground surface ranging from 54.9 m in TH20-2 to 37.2 m in TH20-3.

5.6 Bedrock Quality

The bedrock at this site consisted of clay shale, sandstone, and siltstone in alternating layers. The strength of the bedrock varied from extremely weak to weak (in rock mechanics terminology). Bentonite layers were encountered within each of the three test holes in which bedrock was cored, in addition to coal seams up to 1.1 m in thickness.

The quality of the bedrock mass can be determined by measuring the Rock Quality Designation (RQD) index which is the ratio of the aggregate length of core pieces over 100 mm in length to the total length of core recovered, expressed as a percentage. This provides a measure of the amount of fracturing in recovered bedrock core. An RQD of 100 percent would indicate that there were no pieces less than 100 mm length in the entire run of core recovered, corresponding to a rock of very good quality. The overall RQD for the coring is summarized in Table 5.1 arranged by abutment and pier test holes.

**TABLE 5.1
RQD CORE CLASSIFICATION**

RQD VALUE (%)	QUALITY	% OF ALL CORE RUNS AT WEST ABUTMENT LOCATION (TH20-1)	% OF ALL CORE RUNS AT EAST ABUTMENT LOCATION (TH20-2)	% OF ALL CORE RUNS AT BRIDGE CENTER LOCATION (TH20-3)
0 – 25	Very Poor	33	50	57
25 – 50	Poor	0	0	43
50 – 75	Fair	50	0	0
75 – 90	Good	17	40	0
90 - 100	Very Good	0	10	0

Notes: RQD = Rock Quality Designation – a measurement of the amount of fracturing in recovered bedrock core

The strength classification of the bedrock is summarized in Table 5.2 based on the visual classification combined with laboratory strength testing. The laboratory uniaxial compressive strength results of the bedrock fell within the R0 to R2 category.



**TABLE 5.2
ROCK STRENGTH ESTIMATE**

ROCK CLASS	UNIAXIAL COMPRESSIVE STRENGTH (MPA)	STRENGTH TERM	% OF ALL CORE RUNS AT WEST ABUTMENT LOCATION (TH20-1)	% OF ALL CORE RUNS AT EAST ABUTMENT LOCATION (TH20-2)	% OF ALL CORE RUNS AT BRIDGE CENTER LOCATION (TH20-3)
R0	0.25 – 1	Extremely Weak	86	61	99
R1	1 – 5	Very Weak	0	15	1
R2	5 – 25	Weak	4	0	0
R3	25 – 50	Medium Strong	0	0	0
R4	50 – 100	Strong	0	0	0
R5	100 – 250	Very Strong	0	0	0
R6	>250	Extremely Strong	0	0	0
No recovery			10	24	0

Poor recovery was encountered in TH20-2 and TH20-3 in the upper portions of the bedrock due to difficulty with the employed drilling method, sand flowing from the overlying formation, loss of drill fluid circulation, and loss of core samples during drill string retrieval. Based on observations made at the time of drilling it is not anticipated that the poor core recovery in this zone is indicative of poor rock conditions, but rather an artifact of the drilling method and conditions.

5.7 Groundwater Conditions

Groundwater seepage was observed at the completion of drilling in test holes that were not advanced using wet rotary methods before the installation of geotechnical instrumentation. Additionally, water levels were measured in the vibrating wire piezometers on November 2, 2020 November 20, 2020, and January 25, 2021 for TH20-1 and TH20-2. As previously mentioned, the City is responsible for reading the instruments that were installed in TH20-4 and TH20-5. These piezometers were read at different times than the Thurber instruments by City staff and the results were provided to Thurber. Updated groundwater levels were also measured in TH14-1 and TH14-2 on January 25, 2022.

The measured water levels in the standpipes and vibrating wire piezometers are summarized in Tables 5.3 and 5.4.

Portions of the test holes were advanced using wet rotary drilling inside casing which does not permit observation of seepage or sloughing.



**TABLE 5.3
SUMMARY OF SLOUGH AND GROUNDWATER LEVELS MEASURED BY THURBER**

TEST HOLE	TEST HOLE DEPTH B.G.S. (m)	SEEPAGE OBSERVED B.G.S. (m)	SLOUGH ON COMPLETION B.G.S. (m)	VIBRATING WIRE PIEZOMETER SERIAL NO.	TIP DEPTH (m)	GROUNDWATER LEVELS ON NOV. 2, 2020		GROUNDWATER LEVELS ON NOV. 20, 2020		GROUNDWATER LEVELS ON JAN. 25, 2021	
						B.G.S. (m)	ELEV. (m)	B.G.S. (m)	ELEV. (m)	B.G.S. (m)	ELEV. (m)
TH20-1	54.0	N/A	N/A	68652	6.0	6.0	658.2	DRY	DRY	DRY	DRY
				68653	21.6	17.8	646.4	18.3	645.8	18.7	645.4
				68656	44.8	35.1	629.1	35.1	629.1	35.2	629.0
TH20-2	60.2	N/A	N/A	68649	5.0	DRY	DRY	DRY	DRY	DRY	DRY
				68651	20.0	18.8	645.0	19.0	644.7	18.9	644.3
				68655	44.0	33.7	630.0	33.7	630.0	33.8	629.9
TH20-3	44.7	N/A	N/A	N/A	N/A	N/A	N/A	N/A	N/A	N/A	

Notes:
B.G.S = Below Ground Surface

**TABLE 5.4
SUMMARY OF SLOUGH AND GROUNDWATER LEVELS MEASURED BY CITY OF EDMONTON**

TEST HOLE	TEST HOLE DEPTH B.G.S. (m)	SEEPAGE OBSERVED B.G.S. (m)	SLOUGH ON COMPLETION B.G.S. (m)	VIBRATING WIRE PIEZOMETER SERIAL NO.	TIP DEPTH (m)	GROUNDWATER LEVELS ON OCT 27, 2020		GROUNDWATER LEVELS ON NOV. 25, 2020		GROUNDWATER LEVELS ON JAN. 25, 2021	
						B.G.S. (m)	ELEV. (m)	B.G.S. (m)	ELEV. (m)	B.G.S. (m)	ELEV. (m)
TH20-4	14.9	11.4	14.5	68648	5.0	DRY	DRY	DRY	DRY	DRY	DRY
				68650	12.2	5.8	658.1	6.2	657.7	6.8	656.9
TH20-5	10.4	2.0	10.1	69899	9.2	5.0	648.6	6.4	647.1	7.6	645.9

Notes: B.G.S = Below Ground Surface



It should be noted that groundwater levels can vary in response to seasonal factors and precipitation. In addition, perched groundwater levels may be present in the near surface soils.

The actual groundwater conditions at the time of construction could vary from those recorded during this investigation, and hence it is recommended that the piezometers be read again prior to construction.

5.8 Frost Penetration

The surficial clay and clay fill materials are considered to have moderate frost susceptibility. The expected depths of frost penetration have been estimated using averaged thermal parameters estimated for the materials encountered at the project site and estimates of air freezing indices in the general area. The frost penetration has been estimated for both the mean annual Air Freezing Index (AFI) of 1440°C-days and the 50-year return period Air Freezing Index of 2400°C-days. The estimated frost penetration depths for the mean annual and 50-year return AFI are 1.6 m and 2.4 m, respectively.

The estimated depths of frost penetration are based on a uniform soil type with no snow/insulation cover. If the area is covered with turf or significant snow, the depth of frost penetration will be less. The 50-year return frost penetration depth is typically used for design purposes.

6. GEOTECHNICAL ASSESSMENT AND RECOMMENDATIONS

6.1 Bridge Foundations

6.1.1 General

It is understood that the new bridge will be constructed generally along the same alignment as the existing bridge with a replacement of the superstructure. The recommendations provided in the following sections are primarily targeted towards a newly constructed bridge with new foundation elements.

The preliminary design concepts provided by AEAL indicate that the foundation system will have one of three configurations, as shown in Appendix A. Hence, the design may include foundations both near the ravine crest area and within the ravine along the ravine slopes.

It should be noted that there are significant existing foundation structures present along the existing bridge alignment. These structures include the pier caps, footings, and timber piles for the existing original arch foundations as well as the grid of helical steel (screw) piles that were installed as part of the 2014 shoring work. We would not recommend complete removal of the foundations of either of these elements as it is expected that this would cause significant disturbance to the subsurface in the headslope areas. However, cutting the foundations off below finished grade (up to 1.0 m) is considered acceptable. It is anticipated that the position of these foundations will limit and dictate the position of any future in-ravine foundation locations as they must be properly positioned in order to avoid any conflict with existing underground foundation structures.



As previously discussed in Section 5 and illustrated on Drawing No. 28874-2, in Appendix A, the subsurface soils consist of high plastic native clay, overlying medium plastic clay till, overlying very dense sand, overlying clay shale and sandstone bedrock. Surficial clay fills are also present along the bottom of the ravine and in the abutment areas, which are presumably disturbed grading materials in these areas from bridge, trail, and shoring construction.

Given the site conditions and location, the following pile types are considered feasible for the support of the proposed bridge structure. The appropriate founding layer for the piles is dependent on the foundation element location along the centreline of the bridge as well as the specific structural demands for that element.

- Straight shaft Cast-in-Place (CIP) concrete piles founded in the clay till, sand, or bedrock
- Enlarged (belled) Cast-in-place (CIP) concrete piles founded in the clay till
- Driven steel pipe or H-piles driven to practical refusal in the very dense Empress sand formation.

Driven steel piles are considered less desirable and risky at this location for several reasons, including:

- The close proximity to surrounding residential areas as the construction of driven piles creates noise and vibration that can be extremely disruptive to homeowners and existing foundations. In addition, hard driving to meet practical refusal in the very dense sand is anticipated because excessive vibrations and noise.
- The ravine slopes surrounding the bridge location show evidence of previous movement and can be considered marginally stable and sensitive to vibration forces.
- A significant pre-construction survey, construction monitoring, and post-construction survey program will be required to ensure that no significant damage or movement will be caused to nearby structures and slopes will be caused by the vibrations due to driven pile installation.

The selection of the most appropriate foundation type depends on anticipated loads, site location, site access constraints, tolerable movements, and sub-surface conditions at the bridge support location. Although the old bridge was supported on footings, pile foundations are preferred to limit settlement and differential settlement of the bridge. If consideration is given to using footings to support the new bridge, the new footings will have to be founded on undisturbed competent clay till below the existing footings in order to limit future movements. This will however require significant excavations or the use of deep temporary excavation support system to construct the new footings. Settlement analyses should be undertaken if it is decided to pursue the footing option.

Preliminary recommendations for design and installation of pile foundations and abutments are provided in the following sections. Preliminary recommendations for bridge abutment slopes are presented in Section 6.2. It should be noted that the recommendations are based on the soil and bedrock conditions encountered at the test hole locations and there is potential for some variability of subsurface bearing conditions between these locations.



Recommendations for the stabilization of noted landslide areas north of the bridge on the west side of the ravine will be presented under separate cover following additional monitoring.

6.1.2 Axial Capacity of Piles

Pile foundations are considered feasible to support the bridge replacement.

The ultimate geotechnical pile capacity for Limit States Design (LSD) is defined as follows:

$$Q_T = Q_B + Q_s \text{ (kN)}$$

Where:

QT = Ultimate geotechnical pile capacity (kN)

QB = Ultimate end bearing resistance (kN)

Qs = Ultimate skin friction (kN).

The factored ULS pile capacities are based on the product of the estimated ultimate pile capacity and appropriate geotechnical resistance factors. The geotechnical resistance factors are prescribed in the National Building Code (NBC, 2010) and are dependent on the method of determination of the ultimate pile capacity, as summarized in Table 6.1.

**TABLE 6.1
RECOMMENDED GEOTECHNICAL RESISTANCE FACTOR
FOR LIMIT STATES DESIGN OF DEEP FOUNDATIONS**

DESCRIPTION	GEOTECHNICAL RESISTANCE FACTOR (GRF)
(a) Resistance to axial load	
<i>(i) semi-empirical analysis using laboratory and in-situ test data</i>	<i>0.4</i>
(ii) analysis using static loading test results	0.6
(iii) analysis using dynamic monitoring results	0.5
<i>(iv) uplift resistance by semi-empirical analysis</i>	<i>0.3</i>
(v) uplift resistance using loading test results	0.4
<i>(b) Resistance to horizontal load</i>	<i>0.5</i>

Note: Use ***bolded italic*** values for preliminary design

6.1.2.1 Cast-in-Place Concrete Piles

Straight shaft CIP friction piles, founded in the clay till, sand or bedrock, may be designed based on the skin (shaft) friction values provided in Table 6.2.

**TABLE 6.2
ULS SHAFT FRICTION VALUES FOR CAST-IN-PLACE CONCRETE PILES**

ELEVATION (m) <small>(a)</small>	SOIL TYPE	ULTIMATE SHAFT RESISTANCE (kPa)	FACTORED ULS SHAFT RESISTANCE IN COMPRESSION (kPa) (GRF = 0.4)
664-650	Native Clay Fill, Native Clay, and Clay Till	35	14
650-645	Native Clay Till	50	20
645-639	Native Clay Till and Native Sand (Empress Formation)	70	28
639-619	Native Sand (Empress Formation)	80	32
Below 619	Clay Shale Bedrock ^(b)	100	40

(a) Elevations are approximate. Refer to test holes and stratigraphic cross section for elevations and boundaries between various strata. Elevation of Empress Formation varies significantly along the bridge alignment.

(b) Assuming that the base of the pile is at least 5 m into the bedrock

Shaft friction should be ignored in the upper 2 m of the installation, or for the full depth of new fill, whichever is greater.

In addition to the shaft resistance, end bearing resistance may also be considered for straight shaft cast-in-place pile foundations socketed into the clay shale bedrock, assuming that the base is adequately cleaned. The ULS end bearing design value provided in Table 6.3 may be used to calculate the end bearing of the bedrock.

Cast-in-place belled piles in the clay till formation may be designed using the ULS end bearing design value provided in Table 6.3. Shaft resistance should not be accounted for in the design of belled piles in the clay till.

**TABLE 6.3
ULS END BEARING VALUES FOR CAST-IN-PLACE CONCRETE PILES**

SOIL TYPE	ULTIMATE END BEARING RESISTANCE (kPa)	FACTORED ULS END BEARING RESISTANCE IN COMPRESSION (kPa) (GRF = 0.4)
Very Stiff to Hard Clay Till ^(a)	1,000	400
Clay Shale Bedrock ^(b)	3,000	1,200

(a) For end bearing belled piles in the clay till formation, assuming the base is cleaned appropriately, and the base is located at least 10 m below final grade.

(b) For straight shaft end bearing piles in the clay shale bedrock; assuming the base is cleaned appropriately and founded at least 5 m into the bedrock.

Belled end bearing piles should only be considered for the clay till layer. End bearing piles founded in the clay till layer should terminate no lower than an elevation of 645 m, particularly



within the base of the slope. This limit is recommended to avoid drilling through to the underlying sand layer, which varies in top elevation by about 5 m at the bridge location. The end bearing value, provided in Table 6.3 for belled piles, assumes that the bell is located at least 10 m below final grade in the very stiff clay till at or below an elevation of 647 m

For straight shaft end bearing piles socketed in the bedrock, the base of the socket should be located 5 m into the bedrock formation or at least 3 times the socket diameter, whichever is greater, to mobilize the recommended end bearing design parameters.

Friction piles terminated in the sand layer should be located above elevation 633 m. The sand appears to be wet below that elevation and this limit is recommended to reduce the possibility of dealing of excessive sloughing and seepage conditions.

The uplift capacity of straight shaft piles may be estimated using the ultimate skin friction values provided in Table 6.3 and a geotechnical resistance factor of 0.3. The end bearing resistance should be ignored in the design.

The ultimate uplift resistance of the belled pile may be taken as the ultimate bearing resistance of the material above the bell times the area of the annulus between the pile bell and the shaft as provided in the equation below. This assumes that the belled piles are embedded at least three times the base diameter in the very stiff to hard clay till, and hence the mode of failure is essentially a bearing failure of the soil in the annulus above the bell. A geotechnical resistance factor of 0.3 should be used to calculate the factored uplift resistance of the bell.

$$Q_{b(\text{uplift})} = q_b \times (A_B - A_S), \text{ kN}$$

$$Q_{b(\text{uplift})} = \text{Ultimate uplift load in tension}$$

$$q_b = \text{Ultimate bearing resistance of soil above base (use 600 kPa)}$$

$$A_B, A_S = \text{Area of base and shaft respectively (m}^2\text{)}$$

Piles subjected to frost heave forces should be checked for adequate resistance to uplift. Adfreeze forces may be estimated based on an adfreeze friction value of 65 kPa (Canadian Foundation Engineering Manual, 4th Edition, 2006, p 196). The adfreeze friction value is applied around the pile circumference over the expected depth of freezing (2.4 m below final grade). For belled piles, resistance to frost heave will also be provided by the ultimate uplift resistance of the bell. A geotechnical resistance factor of 0.8 should be applied to the ultimate uplift resistance for resisting frost heave forces.

It should be noted that adfreeze forces need not be combined with transient uplift loads (i.e. wind or seismic). In the case of piles subjected to sustained uplift loads, however, the piles need to be designed to support both the adfreeze and sustained uplift load.

Cast-in-place concrete piles should be designed and installed in accordance with the following recommendations.



- a) A minimum pile shaft diameter of 600 mm is recommended to prevent voids from forming during pouring of the concrete, to deal with obstructions such as cobbles and boulders and facilitate the inspection of the base of the pile.
- b) A minimum pile length of 8 m is recommended to reduce first heave effect.
- c) A minimum pile spacing of three shaft diameters center to center is recommended. Skin friction should be reduced if pile spacing is less than three diameters.
- d) Belled end bearing piles may be used in the clay till as discussed above. The bell diameter to shaft diameter ratio should not exceed 3:1 and the bell should not be sloped at more than 30 degrees to the vertical. The end bearing capacity is based on a minimum depth to bell diameter ratio of three. Where the depth to bell diameter ratio is less, the end bearing resistance will need to be reduced.
- e) For belled piles, a minimum edge-to-edge spacing between adjacent bells equivalent to half of the bell diameter or 500 mm, whichever is greater, is recommended to reduce potential construction issues.
- f) Pile installations within about three times pile diameter should not be drilled and poured consecutively within 24 hours of each other, to allow sufficient time for set-up of concrete in the first pile. Hence this may require staggering of pile installations and the schedule of pile installations should be properly planned to reduce conflicts with previously poured piles.
- g) All pile excavations should be thoroughly cleaned and visually inspected by qualified geotechnical personnel prior to pouring of the concrete to ensure a satisfactory base has been achieved. No slough or disturbed material should be allowed to remain in the pile excavations. Where sloughing sand or silt layers are encountered at the design level, it will be necessary to provide temporary casing of the pile hole in order to form the bells.
- h) Longitudinal reinforcement should be provided through the pile shaft to resist potential uplift forces on the pile due to frost action and seasonal moisture variations. If piles are designed as tension elements, the pile reinforcing should be designed to resist the anticipated uplift stresses.
- i) Cobbles and boulders may be encountered in the clay till or existing fill and this may hamper the installation of the piles.
- j) Groundwater should not be allowed to accumulate in the pile excavation. A robust temporary casing will likely be required to prevent sloughing/seepage into the pile holes from wet sand layers (either in the Empress Formation or within the clay till formation), water bearing coal and bedrock fractures. If seepage is too fast to maintain the pile hole dry long enough for concrete pouring, the water should be allowed to fill the hole to the hydrostatic level and then concrete should be tremied from the bottom of the hole to displace the water. A concrete pump and piping may be used for this purpose, maintaining a head of concrete above the base of the tremie pipe at all times to avoid mixing of the concrete with water. If it is not possible to establish a dry hole, Crosshole Sonic Logging (CSL) or Thermal Integrity Profiler (TIP) testing should be undertaken to confirm the integrity of the piles.

- k) A piling rig with double rotary drilling capabilities should be considered to advance the piles within the Empress sand layer. Within this system, the casing and auger are simultaneously installed and subsequently extracted.
- l) Concrete should be poured immediately after drilling of the pile hole to reduce the risk of groundwater seepage and sloughing soil.
- m) The concrete materials and construction methods used should comply with CSA A23.1-09/A23.2-19.

The following recommendations should be considered for rock socketed piles.

- Pile sockets, ribbed or not, should be cleaned and roughened with a steel wire brush attachment to remove any clay that might have been smeared on the circumference of the socket. This is critical for bonding of concrete to undisturbed rock.
- To provide a better bond between the soil (or bedrock) and the pile shaft, the shaft could be “ribbed”. Ribs should be cut as 75 mm by 75 mm grooves in the shaft perimeter at 0.5 m depth intervals.
- The ribs cut into the excavation sidewall should be inspected for conformance with the depth and spacing requirements, and the side wall should be inspected to confirm that the bedrock is not softened.
- End bearing resistance may only be included in the design if the pile bases are thoroughly cleaned with no loose or disturbed material remaining. The final base cleaning would need to be completed after the ribs have been cut.
- Down-hole camera inspection will be required to assess whether the sidewalls, ribs, and base have been adequately cleaned.
- A piling contractor who has experience drilling piles in bedrock of variable strength and quality should be selected for the work. A variety of augers with hard carbon rock teeth, core barrels (to cut through strong sandstone layers), wire brushes, and scraper buckets will be required to complete the work.
- The bedrock may tend to slake and soften over time when exposed to water. Therefore, it is recommended that concrete be poured in the pile socket as soon as the drilling is completed.

6.1.2.2 Driven Steel Piles

As previously discussed, the bridge abutments and piers may be founded on steel piles driven to practical refusal in the Empress sand formation. However, the issues raised in Section 6.1.1 regarding this type of foundation system should be considered.

The following recommendations are provided for the design and installation of driven steel pile foundations at this site:

- a) Steel piles should be driven to a minimum depth of 10 m and the appropriate set criteria, where practical, depending on the pile sizes and loads.

- b) Driven steel pipe and H-section piles may be designed based on a combination of shaft friction and end-bearing resistance. Recommended ultimate and factored ULS geotechnical skin friction and end-bearing values are provided in Tables 6.4 and 6.5.

**TABLE 6.4
ULS SHAFT FRICTION VALUES FOR DRIVEN STEEL PILES**

ELEVATION (m) ^(a)	SOIL TYPE	ULTIMATE SHAFT RESISTANCE (kPa)	FACTORED ULS SHAFT RESISTANCE IN COMPRESSION (kPa) (GRF = 0.4)
664-650	Native Clay Fill, Native Clay, and Clay Till	30	12
650-645	Native Clay Till	40	16
645-639	Native Clay Till and Native Sand (Empress Formation)	60	24
Below 639	Native Sand (Empress Formation)	100	40

(a) Elevations are approximate. Refer to test holes and stratigraphic cross section for elevations and boundaries between varies strata. Elevation of Empress Formation varies significantly along the bridge alignment.

**TABLE 6.5
ULS END BEARING VALUES FOR DRIVEN STEEL PILES**

SOIL TYPE	ULTIMATE END BEARING RESISTANCE (kPa)	FACTORED ULS END BEARING RESISTANCE IN COMPRESSION (kPa) (GRF = 0.4)
Very Dense Sand ^(a)	7,000	2,800

(a) For steel piles driven to practical refusal in the sand formation (to be confirmed by PDA testing), assuming the tip is located at least 10 m below the final grade and embedded at least 2 m into the very dense sand; top elevation of sand varies and allowance should be made in the contract to account for possibility of driving longer or shorter piles than designed.

- c) Shaft adhesion should be ignored in the upper 2 m of the pile shaft to account for the possibility of soil shrinkage or pile flutter during driving, which may result in poor contact between the pile shaft and soil. Shaft adhesion should also be ignored within the design scour depth (if applicable) at pier locations.
- d) Practical refusal may take place within the upper few meters of the very dense Empress sand formation, and hence caution should be exercised when using skin friction values of the very dense sand to calculate the pile capacity in tension and compression.
- e) The top elevation of the Empress formation varies significantly and hence allowance should be made in the contract for the possibility of driving piles shorter or longer than designed.



- f) The end-bearing resistance and skin friction of the pile should be applied to the plugged end area and plugged perimeter of the pile, respectively.
- g) A minimum pile length of 10 m is recommended for lightly loaded piles to provide adequate resistance to frost heave forces.
- h) The maximum geotechnical stress of a driven pile is function of the dynamic impedance, which is proportional to the steel cross sectional area. In other words, a thicker wall steel pile can be driven to greater depth and geotechnical resistance than a thinner wall steel pile. For preliminary design, the factored ULS geotechnical pile capacity under static loading should be limited to a static stress of 110 MPa times the cross-sectional area of the steel. Please note that this is different from the structural capacity of the pile, which may be greater than the geotechnical capacity. The maximum geotechnical resistance may be increased based on the results of pile load tests.
- i) For preliminary design, pipe piles should have a maximum outer diameter to wall thickness ratio of 50. Pipe piles should be driven open ended to reduce issues with wandering during driving and meeting premature refusal to driving. If pipe piles are to be filled with concrete to increase their stiffness, only the upper few meters of the disturbed soil inside the pile should be drilled out. The lower “plug” of soil must remain intact inside the pile or a reduction in end bearing must be applied.
- j) The recommended skin friction values assume a minimum center-to-center pile spacing of three diameters or flange widths and should be reduced for closer spacing. Spacing reduction factors can be provided once the preferred spacing of the piles is known.
- k) Pile tips should be reinforced as hard driving might be required through hard clay till and dense sand layers. Tip reinforcement should not extend outside the steel section as this will cause voids to form along the pile shaft during driving, and a consequent reduction of the skin friction load capacity.

Steel piles should be driven with a hammer of appropriate size and rated energy, depending on the pile design load requirements. The pile-driving hammer should be approved in advance of construction and the required pile set should be determined by dynamic analyses such as Wave Equation Analyses (WEAP) for the specific hammer, pile sizes and design loads.

As a general guideline, the driving energy should be limited to 600 J per square cm of steel cross section area. The maximum hammer energy is a function of the cross-sectional area of steel and is not increased by higher grade of steel, beyond a design yield strength of about 300 MPa.

Pile driving records should be maintained during driving of all piles and should be reviewed to confirm that the set criteria have been achieved.

Selected piles at each foundation element (abutment or pier) should be subject to Pile Driving Analysis (PDA) testing to confirm the capacity.

The following guidelines should generally be followed for pile driving and approval:



- a) Piles should be driven to the specified pile embedment depths and to the required set criteria unless the piles meet premature refusal. Practical refusal is generally defined as a blow count of greater than 125 blows per 250 mm (less than 2 mm per blow) but will depend on the design loads, pile type, and type and rated energy of hammer used. Recommended pile set criteria can be provided when these factors are known.
- b) Where the piles reach the target depths and the required set is achieved at the End of Initial Drive, the piles may be accepted.
- c) In the event that the required set is not achieved at the design pile embedment depth, the piles should be allowed to set up for a period of at least 7 days (one week). Selected piles should then be re-tapped to determine if the set requirements are met after “set-up”. The “restrike” should consist of about 10 blows of the same hammer energy used to install the piles and should be conducted on piles that have not been subjected to potential disturbance from driving of adjacent piles within at least 10 m during the “set-up” period.
- d) In the event that premature refusal of the piles is met due to encountering dense material above the target depth, the following conditions should apply:
 - Where the pile tip elevations are within about 2 m of the design tip elevation, and the tip depths are greater than 8 m depth, the design compressive load may be considered acceptable. This is based on the condition that the set criteria are met, and the driving records indicate a trend of increasing blow counts with depth. Piles subjected to uplift loads (either due to tension or frost action or a combination thereof) would still have to be reviewed by the structural engineer for adequate uplift resistance.
 - Where piles meet refusal at more than 2 m above target depth, we should review the records and available soils information to confirm that the piles have adequate capacity. Also, the piles subject to uplift loading should be reviewed by the structural engineer to determine if they have adequate uplift resistance.
 - Where refusal is met at depths of less than 8 m, pre-boring of the piles may be required where the piles will be subjected to frost action. (Recommendations for pre-boring are provided below).
- e) All piles should be checked for plumbness, and potential damage due to driving at the end of the installation. An out-of-plumb tolerance of 2 percent is typically specified for driven steel piles. Care will be required in set-up and driving of the piles to meet these objectives.
- f) Heave of adjacent piles is a concern for close pile spacing and should be monitored throughout the driving. All piles indicating heave should be re-driven to at least the original embedment depths. If necessary, pile heave may be reduced by pre-boring.
- g) Pre-boring may be required where the presence of cobbles or boulders are encountered within the depth of pile installations. Pre-boring might also be required through the frost zone in the event the pile installations are undertaken during winter when the ground is frozen. Where possible, pre-boring should be limited to 25 mm less than the pile diameter.



- h) Driving of deep steel piles may cause a void to form near ground surface due to pile “flutter” during driving. When this occurs, the voids should be backfilled with either grout or tamped sand to maintain the contact between the pile and ground to provide the required resistance to vertical and horizontal loads.

6.1.3 Lateral Capacity of Piles

Pile foundations are capable of supporting lateral loads. It is common practice to design the piles for vertical loads, and then check for pile head deflections, bending moments, and shear forces under the design lateral loads. The pile response under lateral loads is governed by the pile type and size, and the characteristics of soil/bedrock within the upper 6 pile diameters (approximately) below the pile head.

The resistance of vertical piles to horizontal load involves soil-structure interaction and is commonly analyzed using computer finite difference techniques. Lateral pile performance may also be calculated by structural analyses using the modulus of lateral subgrade reaction.

6.1.3.1 Modulus of Horizontal Subgrade Reaction

In this approach, the lateral resistance of soils surrounding the pile shaft may be simulated using the modulus of horizontal subgrade reaction to represent soil stiffness. The recommended values of the modulus of horizontal subgrade reaction and ultimate lateral resistance for the soil units anticipated at the project site is presented in Table 6.6.

**TABLE 6.6
RECOMMENDED MODULUS OF HORIZONTAL SUBGRADE REACTION AND ULTIMATE
LATERAL RESISTANCE FOR BRIDGE PILES**

ELEVATION ⁽¹⁾	SOIL/BEDROCK UNIT	MODULUS OF HORIZONTAL SUBGRADE REACTION, k_{s1} (MN/m ³)	ULTIMATE LATERAL RESISTANCE, Q_u (kPa)
664-650	Native Clay Fill, Native Clay, and Clay Till	0 to 30 ⁽²⁾	0-450 ⁽²⁾
650-645	Native Clay till	60	900
645-639	Native Clay Till and Native Sand (Empress Formation)	100	1,500
639-619	Native Sand (Empress Formation)	120	1,800
Below 619 m	Clay Shale Bedrock	180	3,000

⁽¹⁾ Elevations and approximate. Refer to test hole logs and stratigraphic cross section

⁽²⁾ The modulus of subgrade reaction/ultimate lateral resistance value increases linearly from zero at the finished ground surface to the maximum design value at a depth of three times the pile diameter below final grade.



The horizontal modulus of subgrade reaction (k_{s1}) applies to a pile of unit diameter of 1 m and should be modified for piles of larger or smaller diameter, using the following formula:

$$k_B = k_{s1} \times 1/B \text{ (MN/m}^3\text{)}$$

Where:

k_B = modulus of horizontal subgrade reaction for a pile of diameter B (MN/m³)

k_{s1} = modulus of subgrade reaction for a pile of 1 m diameter (MN/m³)

B = pile diameter or effective width (m).

The spring constant K (MN/m) for a pile of diameter, D, and segment length L, may be related to the horizontal subgrade modulus as follows:

$$K = k_B \times B \times L \text{ (MN/m)}.$$

It should be noted that the modulus of horizontal subgrade reaction is an elastic parameter. Hence, the above given modulus value is valid only as long as soil/bedrock behavior remains within the elastic range. The maximum strain level associated with elastic behavior may be taken as a lateral pile deflection at the pile head of about 6 mm or one percent of the pile diameter, whichever is larger.

When modeling the piles under SLS conditions, if the induced load exceeds the ultimate load that can be sustained by the spring at any level, the excess load should be transferred down to the next lower spring. In this case, the upper spring should be substituted by a resisting force equivalent to the ultimate force of the spring (i.e., $q_u \times B \times L$). For Ultimate Limit State (ULS) design purposes, it is recommended to use the same un-factored spring constant values as in the SLS analyses. However, the failed spring at any level should be replaced by a force equivalent to 50 percent of the ultimate lateral force (i.e., $0.5 \times q_u \times B \times L$), with any excess load transferred down to the next lower spring, where 0.5 in the above example equation represents the applicable GRF.

The results of the structural analysis and resulting pile sizes should be reviewed to confirm that the soil capacity is not exceeded.

6.1.3.2 Group Effect

For pile groups, soil resistance will be lower, and the resulting lateral deflections will be larger than that estimated for individual piles depending on the pile spacing, number of rows of piles and direction of loading.

The modulus of horizontal subgrade reaction and ultimate lateral resistance values presented in Table 6.4 apply to individual piles or piles in a group where the center-to-center pile spacing is



greater than about eight times the pile diameter. For closely spaced piles in groups, there will be interaction between piles and the lateral support to each pile will be reduced accordingly. The lateral deflection of a pile in a group will be larger than the deflection of a single pile subjected to the same load.

In structural analyses using the modulus of horizontal subgrade reaction, pile group interaction may be modeled by applying group reduction factors to the modulus and ultimate lateral resistance values. The group reduction factor will depend on the pile spacing, number and layout of piles, the location of the pile within the group, and the direction of loading, with the least reduction being applied to lead (front) row piles and the highest reduction applied to piles located in third and higher order rows. Group reduction factors are presented in Table 6.7 as a function of pile row and the pile spacing to diameter ratio.

TABLE 6.7
GROUP REDUCTION FACTORS FOR MODULUS OF HORIZONTAL
SUBGRADE REACTION AND ULTIMATE LATERAL RESISTANCE VALUES
(Rollins et al, 2006^(c))

RATIO OF PILE SPACING ^(a) TO PILE SHAFT DIAMETER (OR WIDTH)	GROUP REDUCTION FACTORS		
	Leading Row ^(b) Piles	Second Row ^(b) Piles	Third and Higher Row ^(b) Piles
2.0	0.68	0.36	0.17
2.5	0.74	0.48	0.30
3.0	0.79	0.57	0.41
4.0	0.86	0.72	0.58
5.0	0.92	0.84	0.72
6.0	0.96	0.93	0.83
7.0	1.00	1.00	0.92
8.0	1.00	1.00	1.00

- Centre-to-centre spacing between piles
- Pile rows are aligned at right angle to load
- Rollins, K., Olsen, K., Jensen, D., Garrett, B., Olsen, R., and Egbert, J., 2006. Pile spacing effects on lateral pile group behavior: Analysis. Journal of Geotechnical and Geo-environmental Engineering, 110: 1272-1283

For pile spacing closer than two diameters (including tangent or secant piles) a reduction factor of 0.5 is recommended for the horizontal modulus of subgrade reaction and ultimate lateral resistance value.

Where the pile group lateral deflection exceeds tolerable limits, the individual pile load should be reduced by an appropriate amount to obtain acceptable lateral deflection. In such cases it may be necessary to increase the size of the pile group or the individual pile dimensions in order to support the pile group design load with acceptable lateral deflection.



If requested, for complex pile groups, lateral pile analyses can also be carried out using the method of p-y curves and specialized software such as GROUP or using the Finite Element Program Plaxis.

6.1.4 Pile Caps

Precautions should be taken to prevent heaving of the abutment pile caps due to frost penetration where the pile cap will lie above the seasonal frost line. Either the pile caps should be designed to resist potential frost heave by the applied dead load on the abutments or, alternatively, crushable, non-degradable void form (such as Beaver Plastics Frost Cushion) may be placed below the pile cap or grade beam to accommodate frost heave and reduce frost heave forces on the underside of the pile cap. The ground surface should be sloped away from the pile cap to prevent water from collecting in the void space and freezing. The pile cap should be designed in accordance with the crushing strength of the void filler and the piles must be able to resist the resulting uplift load. A minimum void thickness of 150 mm is recommended.

6.1.5 Earth Pressures and Abutment Wall

A triangular earth pressure distribution may be used for design of abutment retaining structures resisting earth pressures. The lateral earth pressures will depend upon the extent and direction of movement of the soil, nature, and extent of backfill and groundwater conditions.

The horizontal earth pressure, P_h , may be calculated as follows using the coefficients given in Table 6.8 assuming a horizontal backfill surface behind the wall and drained conditions. The horizontal earth pressure P_h at depth h may be calculated as follows:

$$P_h = K [(\gamma \times h) + q] \quad [\text{kN/m}^2]$$

Where:

K = the appropriate coefficient of earth pressure

γ = the bulk unit weight, in kN/m^3

h = the depth below backfill surface, in m

q = applicable surcharge load in kN/m^2 .



**TABLE 6.8
EARTH PRESSURE COEFFICIENTS FOR
VERTICAL RETAINING WALL ASSUMING STIFF WALL,
GOOD SURFACE DRAINAGE AND HORIZONTAL BACKSLOPE**

SOIL DESCRIPTION	BULK UNIT WEIGHT (kN/m³)	ASSUMED FRICTION ANGLE	K_a (Active)	K₀ (Rest)	K_p (Passive)
Gravel Backfill – (compacted to 98% of Standard Proctor Density)	21	35	0.26	0.43	3.8
Low to Medium Plastic Clay Backfill – (compacted to 95% of Standard Proctor Density)	19	23	0.44	0.61	2.3

Note: Values based on assumption of good surface drainage and horizontal backslope.

For rigid non-yielding abutment walls, the coefficient of earth pressure at rest (K_0) should be used. The active earth pressure coefficient (K_a) may be used if the wall is free to rotate 0.001H for granular backfill and 0.01H for clay backfill where H is the height of the abutment wall. It is assumed that the K_0 condition will apply for the bridge abutments at this site.

The earth pressures are governed by the soil type and the extent of selected backfill material behind the wall. To mobilize the recommended active earth pressure values, the mobilized soil zone behind the wall is typically defined by a wedge-shaped zone delineated by projecting a 1H:1V line to ground surface from a point located 0.5 m into the soil from the base of the wall footing. To mobilize the recommended passive earth pressure values, the mobilized soil zone behind the wall is typically defined by a wedge-shaped zone delineated by projecting a 2H:1V line from the base of the wall footing.

Granular fill (e.g. COE Des. 3 Class 25 aggregate with fines contents not exceeding 7 percent or equivalent product) is the recommended backfill type behind the abutment wall since it is easier to compact and place, enhance drainage and reduce frost effect on the wall.

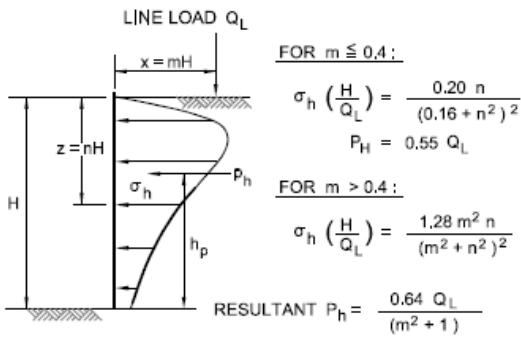
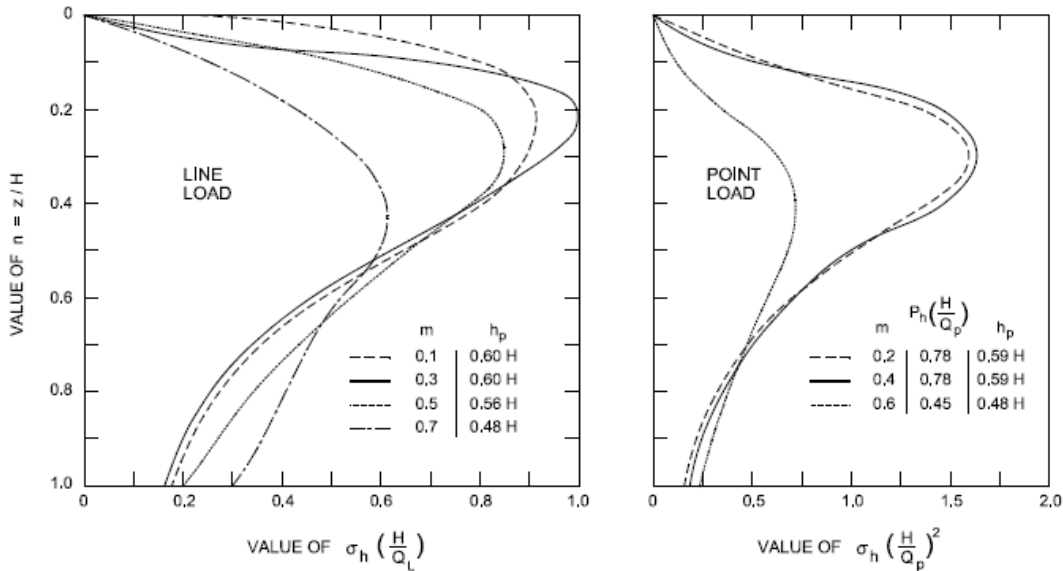
Where traffic or other live loads are imposed behind the retaining wall, the horizontal pressures due to the live load should be superimposed on the earth pressures. Surcharge loading on the walls may be estimated by the methods shown on Figure 6.1.

The surcharge loading due to soil compaction should also be considered. The surcharge loading will depend on the size of compaction equipment used behind the wall. Where heavy compaction equipment is used, and compacted densities greater than 95 percent are required, a minimum design lateral pressure of 16 kPa should be used at the top of the wall to account for compaction-induced forces.

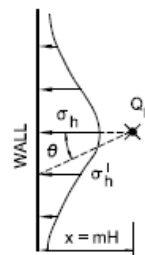
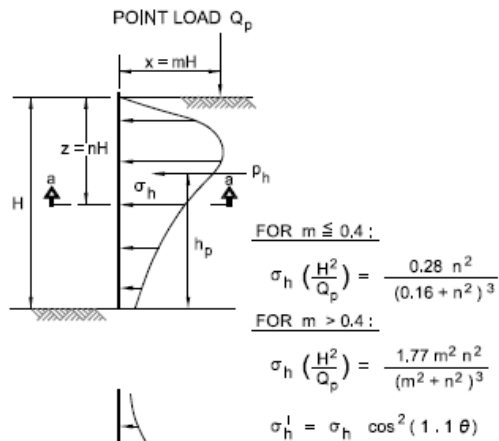
The fill should be placed in maximum lift thickness of 150 mm and be uniformly compacted to at least 98 percent of SPMDD using hand-operated (walk-behind) compaction equipment. Care should be taken not to over-compact the back fill; otherwise higher earth pressures will be created which may distress the wall. To minimize the risks of developing hydrostatic water



pressure and/or frost pressures (due to freezing of clay backfill material), drainage measures should be installed behind walls. A zone of free-draining granular material, at least 0.6 m thick, should be installed directly behind the walls, and should be hydraulically connected to a longitudinal sub-drain running along the base of the wall. The free-draining zone should comprise well graded gravel with a maximum particle size of 25 mm, and no more than 5 percent fines content (soil fraction finer than 0.075 mm). The drainage zone should be capped at surface with a relatively impervious material (e.g. compacted clay cap, asphalt, concrete) to reduce surface infiltration. The sub-drain at the base of the walls should be surrounded with washed gravel encased in non-woven geotextile fabric.



PRESSURES FROM LINE LOAD Q_L
(BOUSSINESQ EQUATION MODIFIED BY EXPERIMENT)



SECTION a-a
PRESSURES FROM POINT LOAD Q_p
(BOUSSINESQ EQUATION MODIFIED BY EXPERIMENT)

HORIZONTAL PRESSURES ON A WALL DUE TO POINT AND LINE LOAD SURCHARGES

FIGURE 6.1



It should be noted that these values are based on an assumed horizontal ground surface behind the wall and should be increased if an inclined ground surface is constructed.

6.2 Bridge Headslope Stability

6.2.1 General

Slope stability analyses were undertaken to evaluate the existing slope stability conditions along the existing east and west headslopes of the current bridge. The western headslope was considered to be the limiting case due to its steeper configuration (approximately 2H:1V in the upper portion compared to the slope of the eastern headslope sloped at approximately 2.3H:1V).

The analyses were carried out two sections: one cut through the centreline of the existing bridge alignment, as shown on Drawing No. 28874-2, which is expected to be comparable to the centreline of the proposed bridge alignment; and one cut through the slope along the north edge of the proposed bridge alignment and widening where previous instability/disturbance has been noted on the western ravine slope due a combination of erosion action and some slope movement.

The slope topography was based on data provided by AEAL and LIDAR data previously acquired by Thurber.

The soil stratigraphy and groundwater conditions were estimated by referring to the nearest test holes and Drawing No. 28874-2. The observed groundwater conditions along the centerline cross section, based on TH20-1 to TH20-2 and TH14-1 to 14-2 drilled at the bridge location, indicate that the groundwater level is approximately 645 m within the clay till layer across the ravine. Although the piezometers installed within the native clay were noted to be dry, seepage was always noted within the clay at an elevation of approximately 658 m. Hence a perched groundwater level at elevation 658 m was assumed for the clay in the analyses. For the north edge section, groundwater levels were noted to be higher within the clay till based on the piezometers installed in TH20-4, and hence a single piezometric line was applied at elevation 658 m to the clay and clay till layers.

The soil parameters used in the analyses are presented in Table 6.9. These parameters are based on the subsurface data collected during the geotechnical investigation, as well as Thurber's previous experience on similar projects. For the north edge section, back analyses were carried out to estimate the extent and the shear strength parameters of the colluvium/disturbed mass.

**TABLE 6.9
SUMMARY OF SOIL AND BEDROCK PARAMETERS
USED IN THE STABILITY ANALYSES**

SOIL TYPE	UNIT WEIGHT (kN/m ³)	EFFECTIVE FRICTION ANGLE (deg)	COHESION (kPa)
Clay Fill	19	22	4
Clay	19	22	4
Clay Till	20	26	8
Sand	20	35	0
Gravel	21	35	0
Colluvium/Disturbed Mass	19	18	3

The stability analyses were evaluated using Slope/W software which uses limit-equilibrium approach and considered that no significant large amounts of additional fill will be placed in the abutment areas and therefore only long-term conditions (without excess pore pressure generated from fill loading) would be representative. Results of the completed analyses are presented in the following subsections.

Based on current state of practice, a long-term FS of 1.5 is required for bridge headslopes. However, a FOS between 1.3 and 1.5 may also be acceptable based on Owner's tolerance to risk and associated consequences.

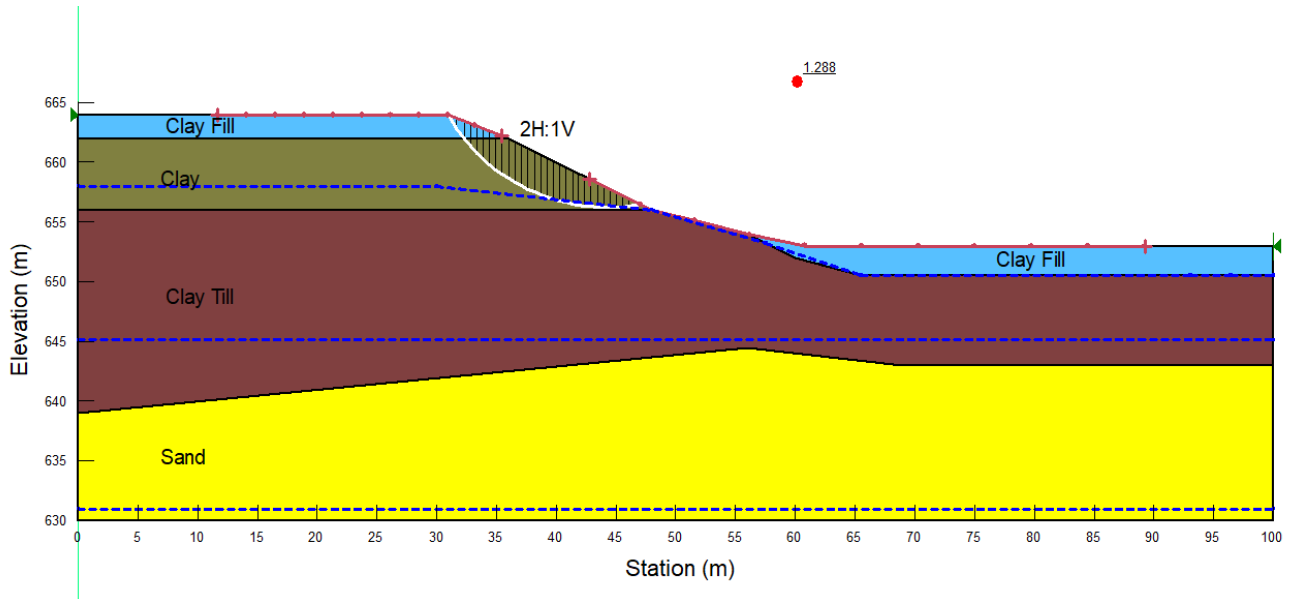
6.2.2 Centreline Headslope

The results of the analyses that were undertaken for the headslope along the centreline of the existing (and future bridge) are presented in Table 6.10 and Figures 6.2 to 6.4.

**TABLE 6.10
RESULTS OF SLOPE STABILITY ANALYSES FOR CENTRELINE HEADSLOPE**

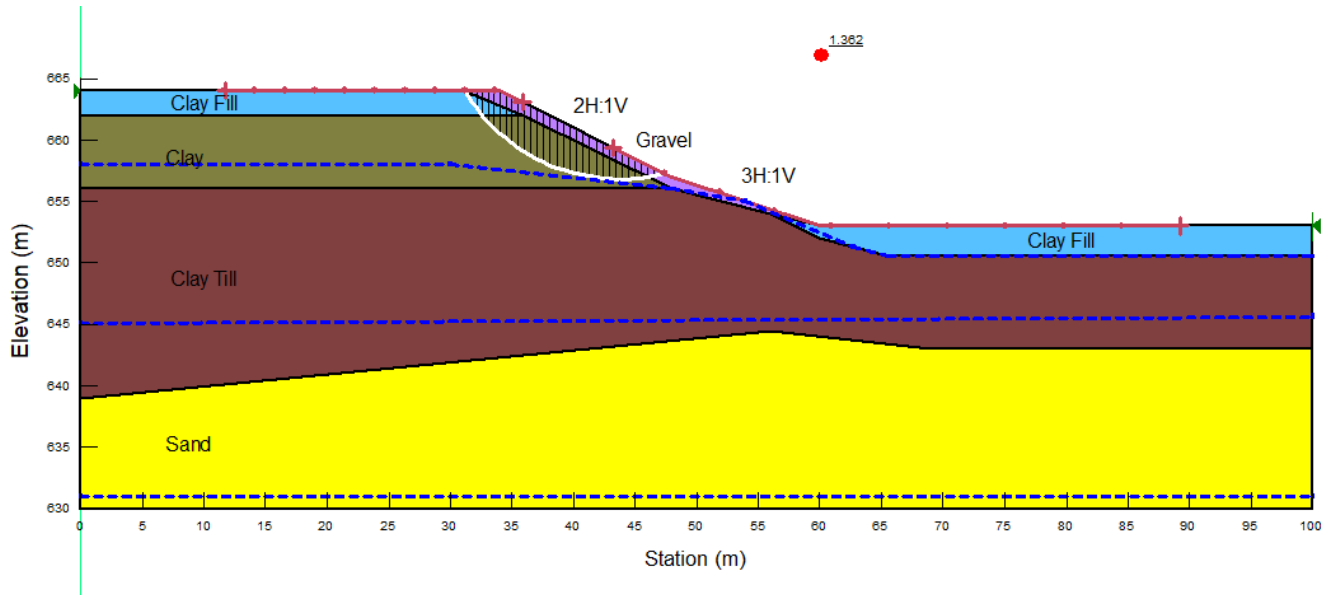
PROFILE	CASE	FACTOR OF SAFETY	FIGURE
West Abutment Headslope Along Bridge Centreline	Existing Condition	1.29	6.2
	New Headslope Configuration	1.36	6.3
	New Headslope Configuration with 8 m Gravel Wedge	1.55	6.4

Figure 6.2 indicates that current factor of safety (FS) of the headslopes is about 1.3. It is likely that the clay fill placed at the base of the slope at the bridge location contributed to the overall stability of the slope. Therefore, the current headslopes do not meet the long-term FOS for bridge headslopes (i.e. a FOS of 1.5).



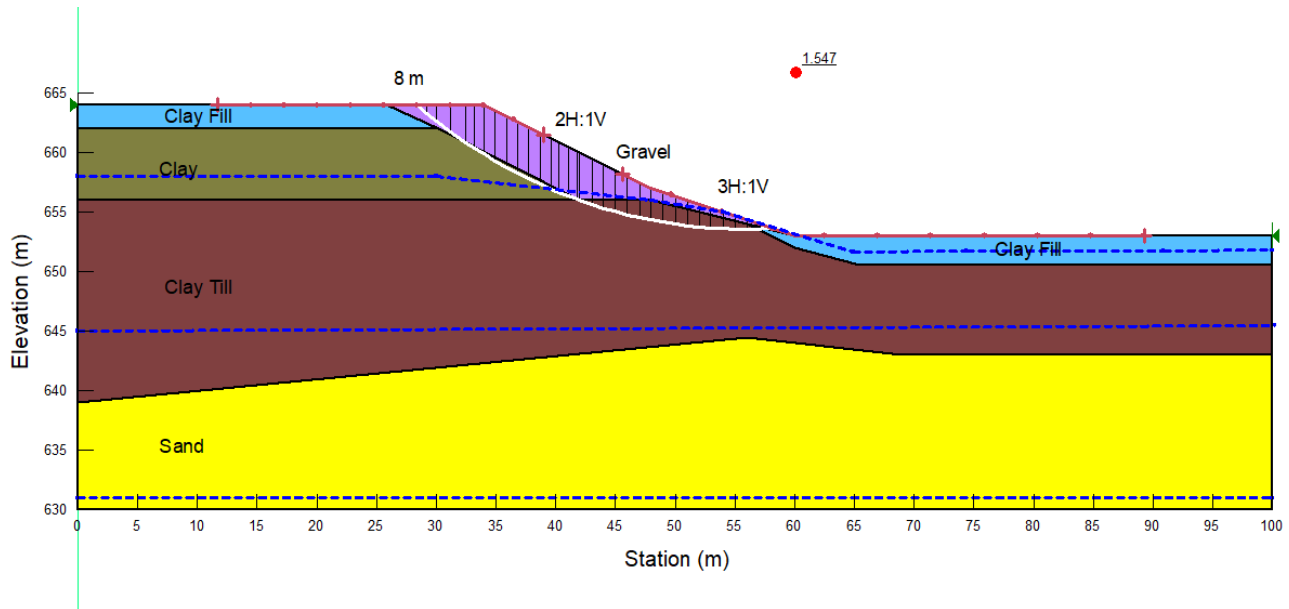
**FIGURE 6.2
CROSS-SECTION A-A WEST HEADSLOPE ALONG BRIDGE CENTRELINE –
BACKANALYSIS**

The next analysis that was undertaken was to determine the stability of the new headslope, as planned and shown in bridge option drawings, which includes an upper slope of 2H:1V and a lower slope of approximately 3H:1V. It is understood that these new slopes would be achieved through minor re-grading and the placement of a relatively thin gravel fill (less than 1 m thick) along the slope face. The results of the analysis shown on Figure 6.3 indicates that a FS of about 1.4 is achieved in this configuration, which does not meet the long-term requirement for headslope stability.



**FIGURE 6.3
CROSS-SECTION A-A WEST HEADSLOPE ALONG BRIDGE CENTRELINE –
NEW HEADSLOPE CONFIGURATION**

An additional analysis was conducted to determine possible measures to increase the FS of the slope to the required value. As shown in Figure 6.4, replacing the face of the headslope down to the top of the clay till at an elevation of approximately 656 m and back for a distance of at least 8 m from the slope crest with an approved crushed gravel would result in a calculated FS of about 1.5; therefore this can be considered a preliminary suitable option for the stabilization of the new bridge headslopes.



**FIGURE 6.4
CROSS-SECTION A-A WEST HEADSLOPE ALONG BRIDGE CENTRELINE –
NEW HEADSLOPE CONFIGURATION WITH 8 m WIDE GRAVEL WEDGE**

However, it should be considered that the portion of the headslope that can be altered will be limited to the locations and elevations where existing foundations (including screw piles) are not encountered.

6.2.3 North Edge Headslope

During discussions with AEAL, it was indicated that the preliminary design options included widening the bridge as compared to its current alignment. It was therefore determined to additionally analyze the portion of the western ravine slope immediately to the north of existing bridge, as this area has been previously recognized as featuring large erosional disturbance from the identified overflowing catch basin. Since the new bridge will be wider, it is expected that this slope area will be impacted by abutment/pier construction.

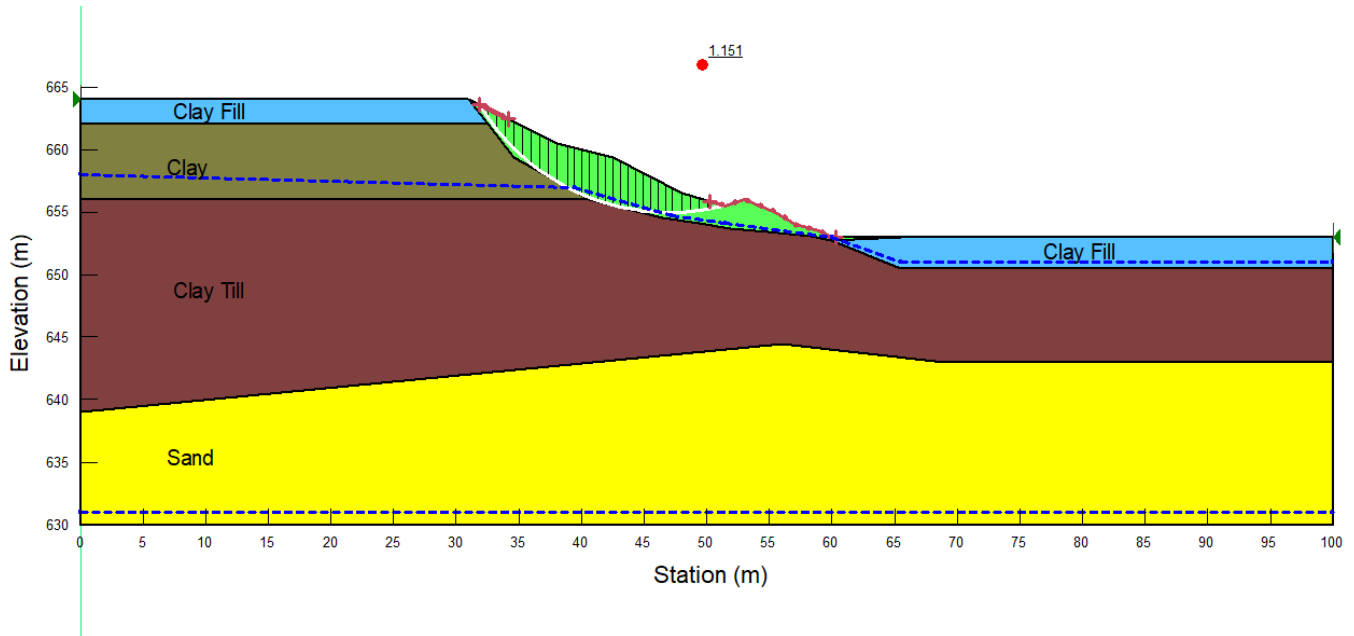
The results of the analyses that were undertaken for the headslope along the north edge of future bridge alignment are presented in Table 6.11 and Figures 6.5 to 6.10.



**TABLE 6.11
RESULTS OF SLOPE STABILITY ANALYSES FOR NORTH EDGE HEADSLOPE**

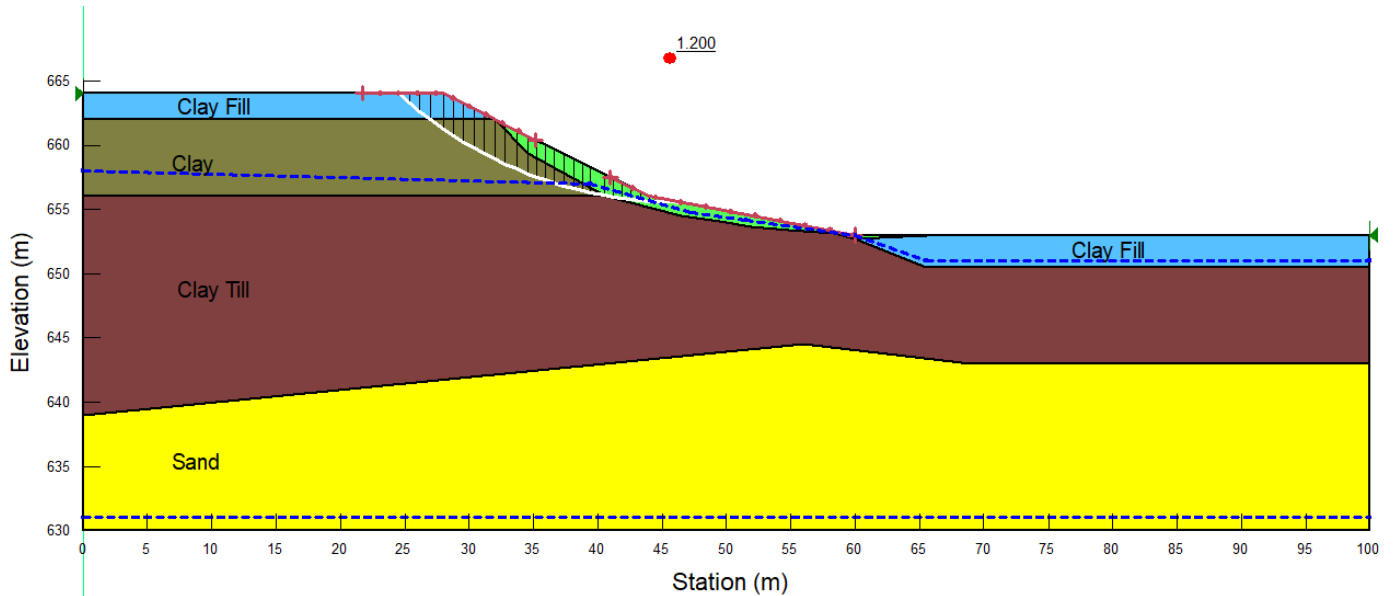
PROFILE	CASE	FACTOR OF SAFETY	FIGURE
<i>West Abutment Headslope Along North Edge</i>	Existing Condition	1.15	6.5
	New Headslope Configuration	1.20	6.6
	New Headslope Configuration with 10 m Pile Wall	1.61	6.7
	New Headslope Configuration with 10 m Gravel Wedge and Geogrid Reinforcement	1.48	6.8
	New Headslope Configuration with 8 m Gravel Wedge and No Geogrid Reinforcement	1.33	6.9
	New Headslope Configuration with 10 m Gravel Wedge and No Geogrid Reinforcement	1.39	6.10

Figure 6.5 shows that current factor of safety (FS) of the slope immediately to the north of the bridge is about 1.15, indicating that the slope is likely creeping with risk of potential future movements. The face of this slope is considered to feature a surface of weaker colluvium material (as shown in light green) that has been caused by surficial slope movements and erosion.



**FIGURE 6.5
WEST HEADSLOPE ALONG NORTH EDGE OF BRIDGE- BACKANALYSIS**

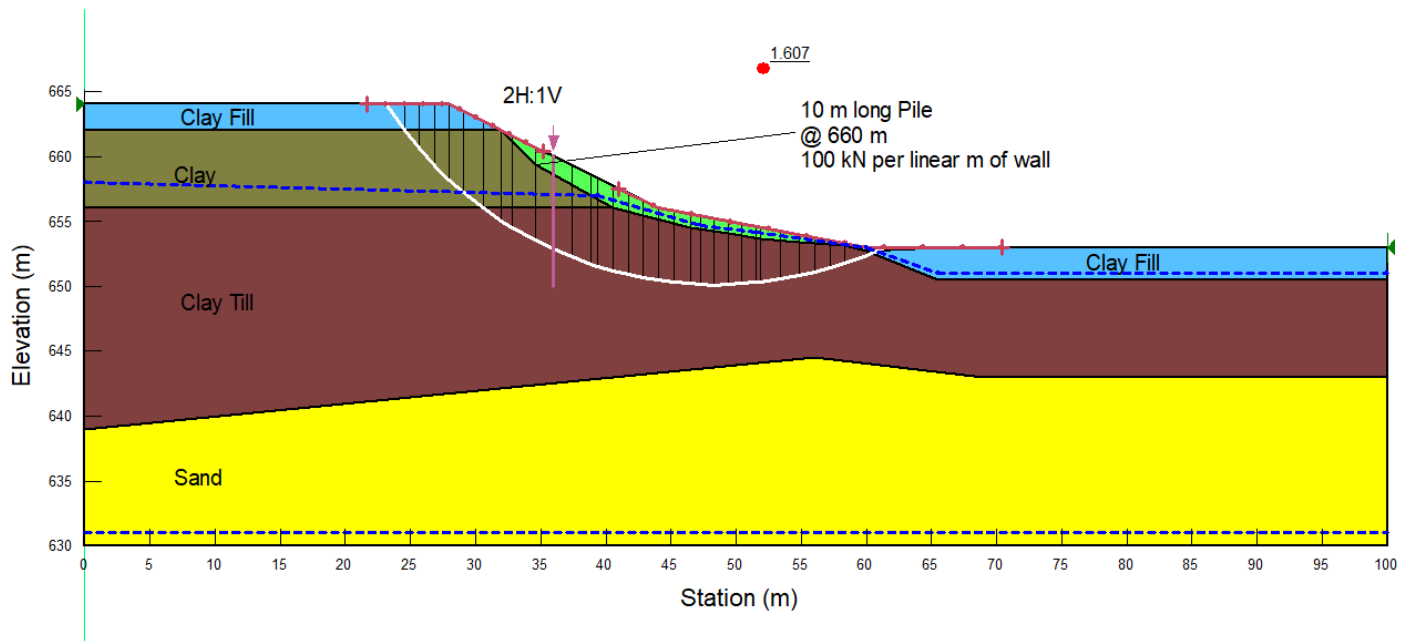
The next analysis that was undertaken was to determine the stability of the new headslope, as planned, which includes cuts into the existing slope in this area to create an upper slope of 2H:1V and a lower slope of approximately 3H:1V. The results of the analysis show on Figure 6.6 indicates that a FS of about 1.2 is achieved in this configuration, which slightly improve the current situation but does not meet the long-term requirement for headslope stability.



**FIGURE 6.6
WEST HEADSLOPE ALONG NORTH EDGE OF BRIDGE –
NEW HEADSLOPE CONFIGURATION**

Additional analyses were then undertaken to determine possible preliminary stabilization measures for the headslope in this area.

Figure 6.7 illustrates the analysis results for the stability of the slope considering the installation of a pile wall (likely a tangent cast-in-place reinforced pile wall) that is at least 10 m deep from a surface elevation of approximately 660 m. This wall would need to sustain an unfactored shear force of at least 100 kN per m of wall length to achieve a FS of 1.5 or greater. If considered, the wall should be extended northward a distance of about 10 m from the north edge of the new bridge alignment to shelter the bridge from future movements. The configuration of the pile wall will need to account for the presence of the outfall structure on the north side of the bridge.



**FIGURE 6.7
WEST HEADSLOPE ALONG NORTH EDGE OF BRIDGE –
NEW HEADSLOPE CONFIGURATION WITH PILE WALL**

The second possible stabilization method that was analyzed was the construction of a 10 m wide gravel wedge along the face of the newly reconfigured headslope, as shown in Figure 6.8. This gravel wedge would also have to contain layered geogrid reinforcement spaced at 1 m vertical intervals throughout the wedge. The minimum long term tensile strength of the geogrid for this arrangement to achieve a FS approaching 1.5, would be 50 kN/m considering all reduction values for long term creep and installation damage related to granular backfill. For comparison, additional analyses were carried out to assess the FOS for 8 and 10 m wide gravel wedges without geogrid. The results of the analyses are shown in Figures 6.8 and 6.9. The FOS is 1.3 and 1.4 for 8 m and 10 m wide gravel wedge, respectively.

The gravel replacement option will require excavation of the slopes and the crescent and likely dealing with the catch basin and outfall structure. The impact of excavation on nearby foundations should be assessed if it is decided to pursue this option. The pile wall option is anticipated to be cause less disturbance than the gravel replacement option.

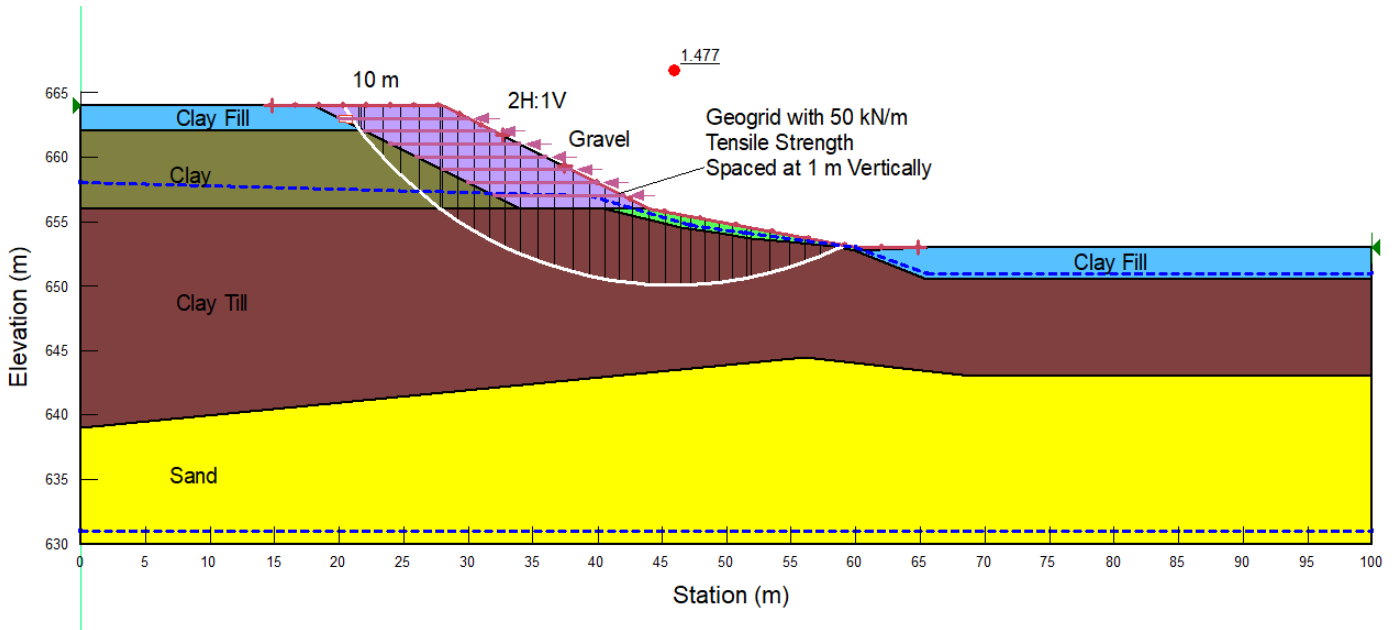


FIGURE 6.8
WEST HEADSLOPE ALONG NORTH EDGE OF BRIDGE –
NEW HEADSLOPE CONFIGURATION WITH 10 m WIDE GRAVEL WEDGE AND GEOGRID
REINFORCEMENT

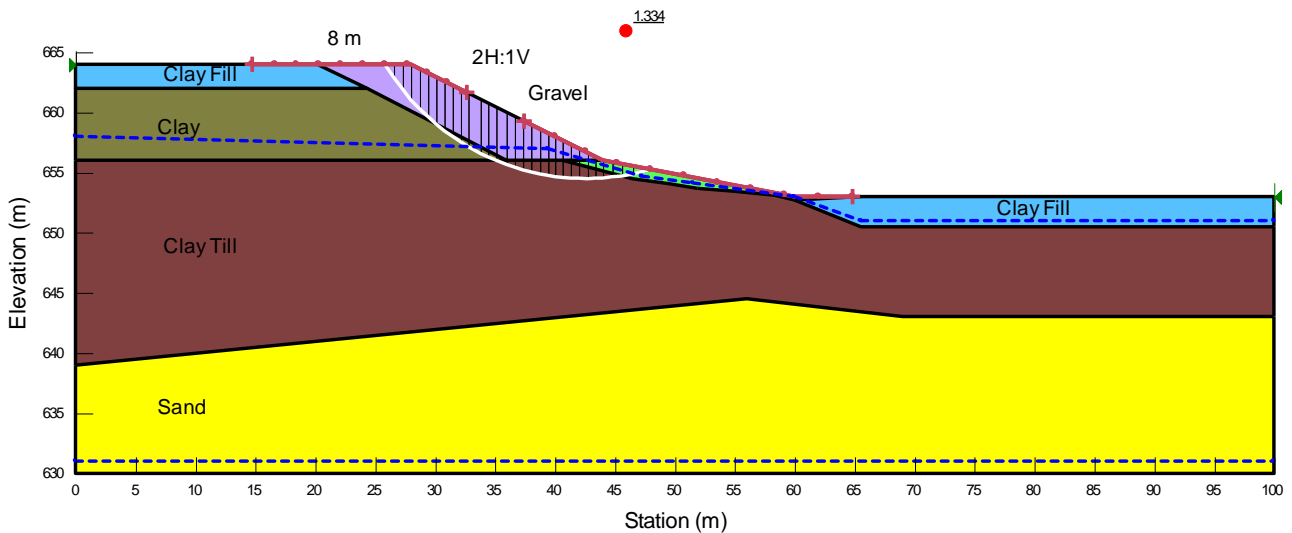
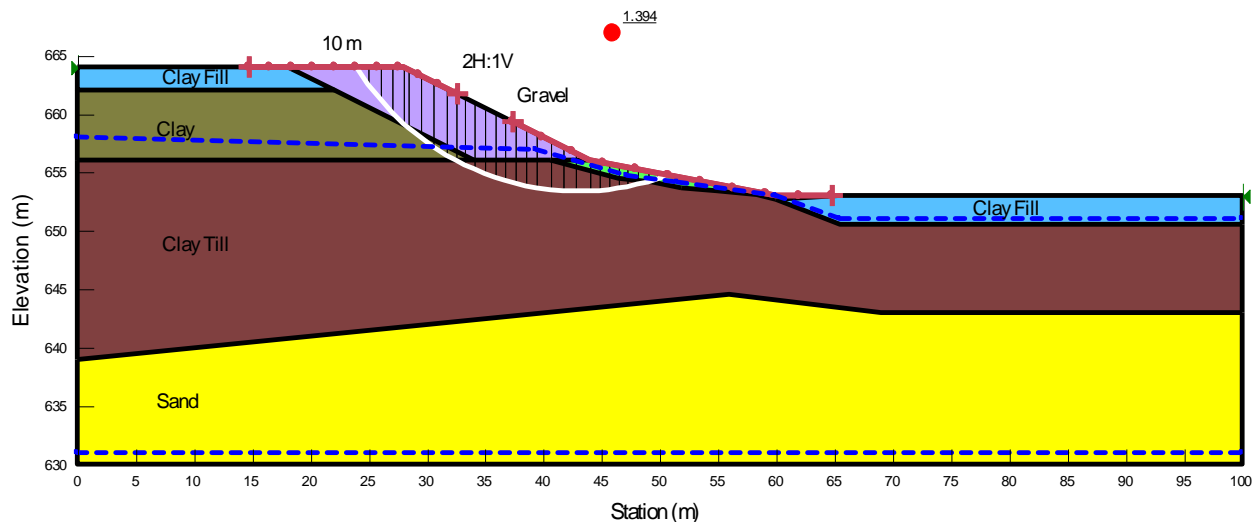


FIGURE 6.9
WEST HEADSLOPE ALONG NORTH EDGE OF BRIDGE –
NEW HEADSLOPE CONFIGURATION WITH 8 M WIDE GRAVEL WEDGE (NO GEOGRID
REINFORCEMENT)



**FIGURE 6.10
WEST HEADSLOPE ALONG NORTH EDGE OF BRIDGE –
NEW HEADSLOPE CONFIGURATION WITH 10 M WIDE GRAVEL WEDGE (NO GEOGRID
REINFORCEMENT)**

6.2.4 Additional Considerations

Considering the proposed 2H:1V headslopes, gravel fill (e.g. COE Des. 3 Class 25 aggregate with fines contents not exceeding 7 percent or equivalent product) is the recommended fill type to build the new headslopes. Gravel should be placed in 150 mm maximum thick lifts and compacted to 98 percent of Standard Proctor Maximum Dry Density (SPMDD) within plus and minus 2 percent of Optimum Moisture Content (OMC). The new fill should be keyed into the native soils/ existing fill to prevent the development of a manufactured slip surface at the interface of native soils/existing fill and granular fill. A clay cap should be provided at final grade to prevent surface water infiltration into the slope. A subdrain should also be included at the base of the gravel zone to maintain dry conditions. The sub-drain should consist of 150 mm perforated pipe, surrounded by washed rock, wrapped in a non-woven geotextile fabric. Riprap protection should be provided at the outlet of the subdrain pipe to prevent future erosion issues.

The proposed design options for the NW slope should shelter the bridge from future movement of adjacent slope but will not deal with the entire landslide block. It is expected that the stabilization effort for the identified landslide area to the north of the west headslope may include options such as gravel replacement (with or without geogrid reinforcement) or a pile wall along with minor grading. The assessment of landslide remedial measures can be completed at a later date following acquisition of slope monitoring data and receiving directions to proceed with the analyses.

The stability of the slopes surrounding the existing headslopes is sensitive to changes in grades, and surface and sub-surface drainage regime. In addition, the presence of retaining walls along



the pedestrian path and mature vegetation on the ravine and adjacent slopes has a significant impact on the stability of these slopes. It is highly recommended to not significantly disturb any of these existing conditions when constructing the new bridge to avoid slope stability issues.

Additional analyses and configurations of the headslope stabilization can be undertaken, as needed, after a bridge option is selected. Final grades in the vicinity of the bridge should be confirmed during detailed design since slopes adjacent to the bridge are very sensitive to grade alteration.

The following should also be considered:

- a) As previously discussed in Section 3.1, there is a catch basin located along the eastern curb of Churchill Crescent and immediately north of 102 Avenue, that occasionally overflows resulting in surface water running over the ravine slope adjacent to the existing abutment causing significant erosion. This catch basin and discharge pipe should be cleaned or reconfigured accordingly to properly deliver runoff into the required outfall pipe at the bottom of the ravine. Continued erosion in this area will negatively affect the stability of the slope adjacent to the bridge and any planned repair measures in this area. The outfall pipe connecting the catch basin and running down the ravine slope also shows some indication of leakage and settling along the ravine slope. The condition of this pipe should be assessed and repaired as required to ensure proper operation.
- b) In addition to the above catch basin, it is recommended that all outfalls and catch basins in the vicinity of the bridge be checked for adequate performance in order to reduce the possibility of ongoing erosional issues on the adjacent ravine slopes. Any other observed erosional channels within the immediate vicinity of the existing bridge should also be repaired during the project.
- c) In general, the site features various culverts and erosion protection features (such as gabion baskets and ravine drainage armoring). It has been observed in the past that some of these features are damaged or not performing properly causing ponding and erosion of surface water at certain times of the year, typically during the spring runoff. These structures should be reviewed and updated as required to ensure there is a functional drainage network in the area around the bridge.
- d) Permanent bridge drainage should be collected and directed in a similar manner to above.
- e) The retaining walls located along the western side of the multi-use path within the ravine, both south and north of the existing bridge should not be altered without further analysis.
- f) Any construction of stabilization measures will have to consider the impacts to surrounding structures/residences, underground and overhead utility and street/sidewalk infrastructure, and residents.
- g) Any required excavations for stabilization installations will have to be analyzed for temporary stability as well as monitored for movement of any surrounding sensitive infrastructure.



- h) Every effort should be made to maintain the mature vegetation (trees, shrubs, grass, etc.) that is present on the ravine and slopes. The root structures of this vegetation are both providing a small amount of surficial slope stability and protecting it from surface water erosion. If any de-vegetation occurs during construction, it is recommended that it be re-established and/or stabilized in an additional manner to ensure stability and protect from long-term erosion. Additional protection measures of slopes may include concrete facing, riprap armoring, turf reinforcement mats, straw wattles, live staking, or a combination of the above as needed.
- i) Construction laydown and stockpile areas should be located in flat areas away from the slopes. No stockpiling should be allowed within at least 20 m from the top of the slopes, or on the slope surfaces. Temporary access trails or ramps for construction, if needed, should be constructed in a way that do not negatively impact the stability of these sensitive slopes.
- j) Heavy cranes and construction equipment should not be left overnight near the top of the slopes to avoid slope stability issues.
- k) Excavations should be undertaken from the crest of the slope progressively working in a direction downwards towards the toe of the slope. Backfill should however be placed from the bottom of the slope working progressively upwards to the top of the slope.
- l) Diverted surface and sub-surface drainage from the construction area should not be directed over the headslopes or adjacent slopes. If required, any collected surface drainage should be directed towards existing storm sewers.

6.3 Cement Type

Sulphate content tests were conducted of four representative subsurface samples to confirm the water-soluble sulphate ion (SO_4) content of soil recovered from the test holes. The water-soluble sulphate ion test results were previously summarized in Table 3.4.

Based on these results, it is expected that the water-soluble sulphate content in the soil samples, will range from 0.02 to 0.04 percent. As per the guidelines of Table 3 of CSA Standard A23.1-09, the subsurface concrete at this site may be exposed to a negligible degree of exposure to sulphate attack and would be suitable for the use of CSA Type GU (General Use) Portland cement.

Following the guidelines of Table 2 of CSA A23.1-09, we recommend that such concrete should have a maximum water to cementing materials ratio of 0.45 with the specified minimum 56-day compressive strength of 32 MPa and should incorporate appropriate air entrainment. Further, such concrete should be cured as per the applicable "Curing Type" stated in Tables 2 and 20.

The recommendations stated above for the subsurface concrete at this site may require further additives and / or modifications due to structural, durability, service life or other considerations which are beyond the geotechnical scope.



In addition, if imported material is required to be used at the site and will be in contact with concrete, it is recommended the fill soil be tested for sulphate content so that the above stated recommendations remain valid.

6.4 Seismicity

The overall site is underlain by a sequence of fill overlying clay overlying clay till overlying sand overlying clay shale and sandstone bedrock.

Based on the results of the geotechnical investigation, the site may be generally classified as Site Class D in accordance with site classification per the National Building Code (NBC 2015).

7. FURTHER INVESTIGATION AND DETAILED DESIGN

As the project progresses through preliminary and detailed design, additional geotechnical analyses and recommendations will be completed as required. The primary focus of the remaining work may include refining the slope stability analyses for the headslope and additional recommendations for bridge foundations once the foundation locations and configurations are determined.

8. LIMITATION AND USE OF REPORT

There is a possibility that this report may form part of the design and construction documents for information purposes. This report was issued before the final design or construction details have been prepared or issued. Therefore, differences may exist between the report recommendations and the final design, contract documents, or conditions encountered during construction. In such instances, Thurber Engineering Ltd. should be contacted immediately to address these differences.

Designers and contractors undertaking or bidding the work should examine the factual results of the investigation, satisfy themselves on to the adequacy of the information for design and construction, and make their own interpretation of the data as it may affect their proposed scope of work, cost, schedule, safety, and equipment capabilities.



STATEMENT OF LIMITATIONS AND CONDITIONS

1. STANDARD OF CARE

This Report has been prepared in accordance with generally accepted engineering or environmental consulting practices in the applicable jurisdiction. No other warranty, expressed or implied, is intended or made.

2. COMPLETE REPORT

All documents, records, data and files, whether electronic or otherwise, generated as part of this assignment are a part of the Report, which is of a summary nature and is not intended to stand alone without reference to the instructions given to Thurber by the Client, communications between Thurber and the Client, and any other reports, proposals or documents prepared by Thurber for the Client relative to the specific site described herein, all of which together constitute the Report.

IN ORDER TO PROPERLY UNDERSTAND THE SUGGESTIONS, RECOMMENDATIONS AND OPINIONS EXPRESSED HEREIN, REFERENCE MUST BE MADE TO THE WHOLE OF THE REPORT. THURBER IS NOT RESPONSIBLE FOR USE BY ANY PARTY OF PORTIONS OF THE REPORT WITHOUT REFERENCE TO THE WHOLE REPORT.

3. BASIS OF REPORT

The Report has been prepared for the specific site, development, design objectives and purposes that were described to Thurber by the Client. The applicability and reliability of any of the findings, recommendations, suggestions, or opinions expressed in the Report, subject to the limitations provided herein, are only valid to the extent that the Report expressly addresses proposed development, design objectives and purposes, and then only to the extent that there has been no material alteration to or variation from any of the said descriptions provided to Thurber, unless Thurber is specifically requested by the Client to review and revise the Report in light of such alteration or variation.

4. USE OF THE REPORT

The information and opinions expressed in the Report, or any document forming part of the Report, are for the sole benefit of the Client. NO OTHER PARTY MAY USE OR RELY UPON THE REPORT OR ANY PORTION THEREOF WITHOUT THURBER'S WRITTEN CONSENT AND SUCH USE SHALL BE ON SUCH TERMS AND CONDITIONS AS THURBER MAY EXPRESSLY APPROVE. Ownership in and copyright for the contents of the Report belong to Thurber. Any use which a third party makes of the Report, is the sole responsibility of such third party. Thurber accepts no responsibility whatsoever for damages suffered by any third party resulting from use of the Report without Thurber's express written permission.

5. INTERPRETATION OF THE REPORT

- a) Nature and Exactness of Soil and Contaminant Description: Classification and identification of soils, rocks, geological units, contaminant materials and quantities have been based on investigations performed in accordance with the standards set out in Paragraph 1. Classification and identification of these factors are judgmental in nature. Comprehensive sampling and testing programs implemented with the appropriate equipment by experienced personnel may fail to locate some conditions. All investigations utilizing the standards of Paragraph 1 will involve an inherent risk that some conditions will not be detected and all documents or records summarizing such investigations will be based on assumptions of what exists between the actual points sampled. Actual conditions may vary significantly between the points investigated and the Client and all other persons making use of such documents or records with our express written consent should be aware of this risk and the Report is delivered subject to the express condition that such risk is accepted by the Client and such other persons. Some conditions are subject to change over time and those making use of the Report should be aware of this possibility and understand that the Report only presents the conditions at the sampled points at the time of sampling. If special concerns exist, or the Client has special considerations or requirements, the Client should disclose them so that additional or special investigations may be undertaken which would not otherwise be within the scope of investigations made for the purposes of the Report.
- b) Reliance on Provided Information: The evaluation and conclusions contained in the Report have been prepared on the basis of conditions in evidence at the time of site inspections and on the basis of information provided to Thurber. Thurber has relied in good faith upon representations, information and instructions provided by the Client and others concerning the site. Accordingly, Thurber does not accept responsibility for any deficiency, misstatement or inaccuracy contained in the Report as a result of misstatements, omissions, misrepresentations, or fraudulent acts of the Client or other persons providing information relied on by Thurber. Thurber is entitled to rely on such representations, information and instructions and is not required to carry out investigations to determine the truth or accuracy of such representations, information and instructions.
- c) Design Services: The Report may form part of design and construction documents for information purposes even though it may have been issued prior to final design being completed. Thurber should be retained to review final design, project plans and related documents prior to construction to confirm that they are consistent with the intent of the Report. Any differences that may exist between the Report's recommendations and the final design detailed in the contract documents should be reported to Thurber immediately so that Thurber can address potential conflicts.
- d) Construction Services: During construction Thurber should be retained to provide field reviews. Field reviews consist of performing sufficient and timely observations of encountered conditions in order to confirm and document that the site conditions do not materially differ from those interpreted conditions considered in the preparation of the report. Adequate field reviews are necessary for Thurber to provide letters of assurance, in accordance with the requirements of many regulatory authorities.

6. RELEASE OF POLLUTANTS OR HAZARDOUS SUBSTANCES

Geotechnical engineering and environmental consulting projects often have the potential to encounter pollutants or hazardous substances and the potential to cause the escape, release or dispersal of those substances. Thurber shall have no liability to the Client under any circumstances, for the escape, release or dispersal of pollutants or hazardous substances, unless such pollutants or hazardous substances have been specifically and accurately identified to Thurber by the Client prior to the commencement of Thurber's professional services.

7. INDEPENDENT JUDGEMENTS OF CLIENT

The information, interpretations and conclusions in the Report are based on Thurber's interpretation of conditions revealed through limited investigation conducted within a defined scope of services. Thurber does not accept responsibility for independent conclusions, interpretations, interpolations and/or decisions of the Client, or others who may come into possession of the Report, or any part thereof, which may be based on information contained in the Report. This restriction of liability includes but is not limited to decisions made to develop, purchase or sell land.



APPENDIX A

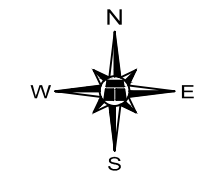
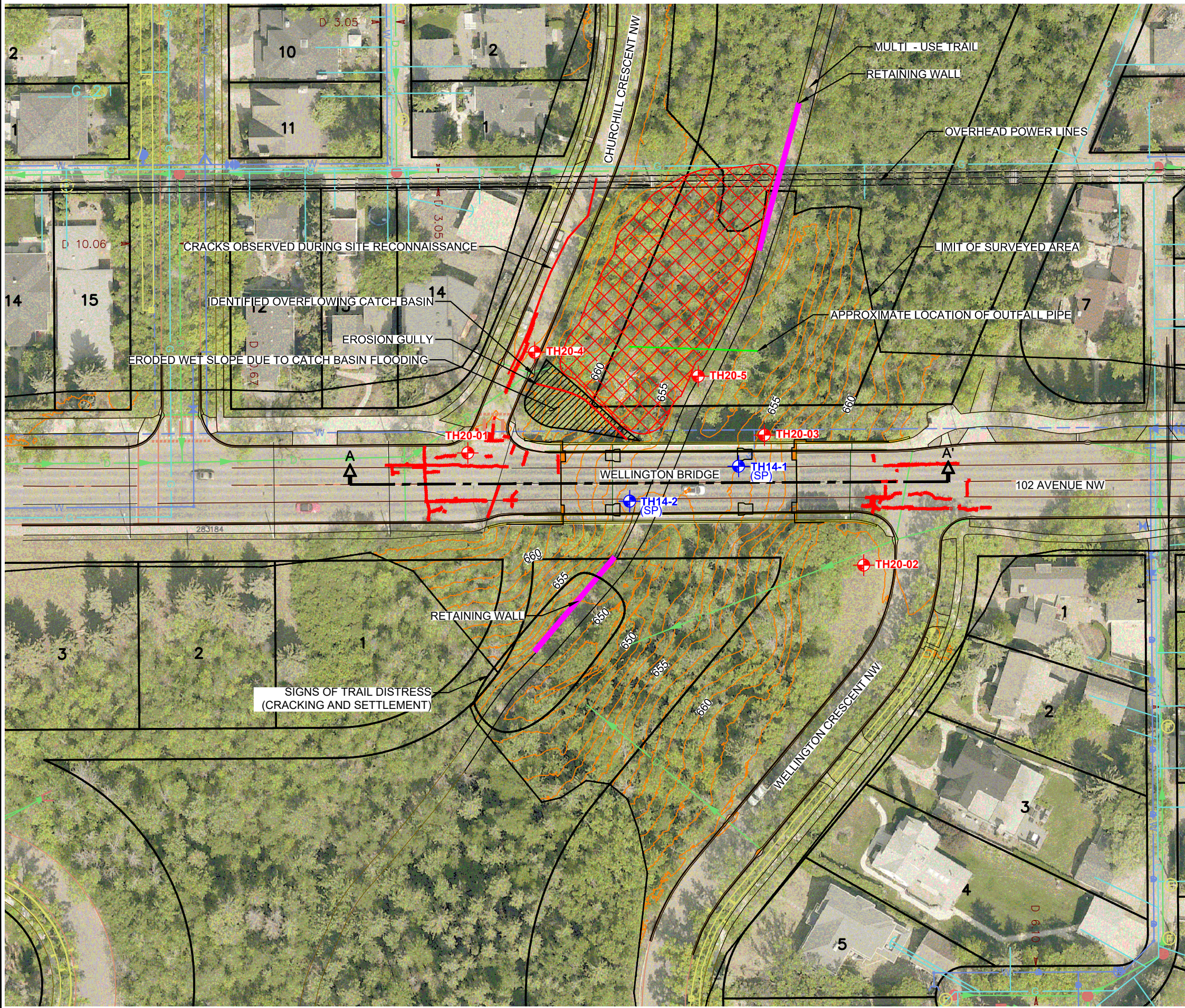
Drawing No. 28874-1 – Site Plan Showing Approximate Test Hole Locations

Drawing No. 28874-2 – Stratigraphic Cross-Section A-A'








Drawing No. 28874-3 – Surficial Geology Map

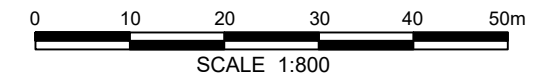
Preliminary Bridge Design Concepts

H:\288000\28874 Wellington Bridge Replacement\Drafting\28874-1 FEB 1, 2021.dwg - 1 - Feb. 01, 2021



LEGEND

-  APPROXIMATE TEST HOLE LOCATION (2020)
-  APPROXIMATE TEST HOLE LOCATION (2014)
-  STANDPIPE PIEZOMETER
-  CRACK
-  GROUND SURFACE CONTOUR (CONTOUR INTERVAL = 1m)
-  OVERHEAD POWER LINE
-  LANDSLIDES IN ADVANCE STAGE: CRACKS AND SLIDE SURFACE DEVELOPED. LANDSLIDES ARE IN DORMANT OR SLOW MOVEMENT CONDITION. POTENTIALLY ACTIVE LANDSLIDES.



2019 AIR PHOTO FROM THE CITY OF EDMONTON



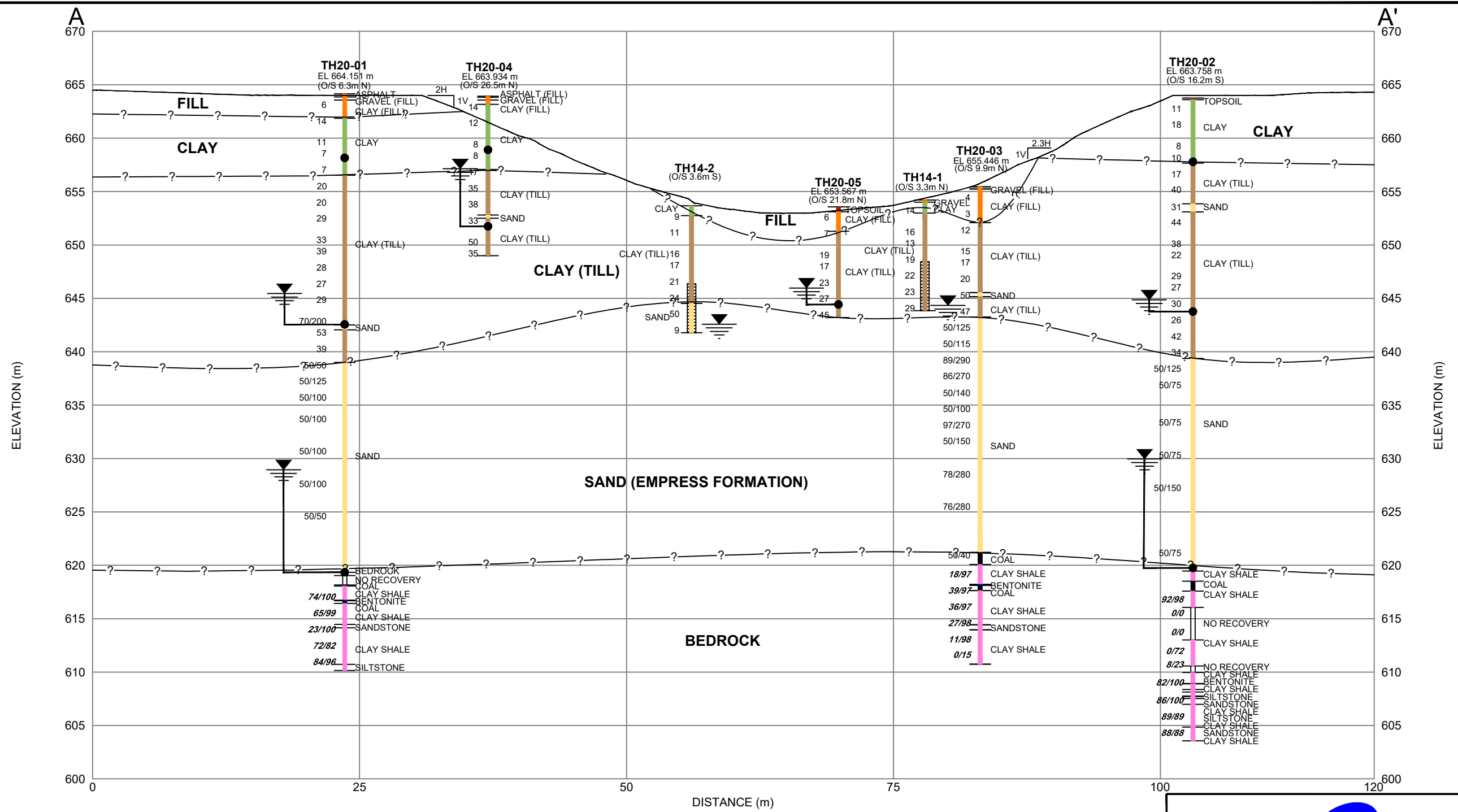
WELLINGTON BRIDGE REPLACEMENT

SITE PLAN SHOWING APPROXIMATE TEST HOLE LOCATIONS

DWG No. 28874-1

DRAWN BY	ML
DESIGNED BY	SEC
APPROVED BY	TSA
SCALE	1:800
DATE	FEBRUARY 2021
FILE No.	28874





LEGEND

- SPT N VALUE
- WATER LEVEL IN PIEZOMETER (JANUARY 25, 2021)
- VIBRATING WIRE PIEZOMETER TIP
- RQD / RECOVERY %
- STANDPIPE PIEZOMETER SCREENED INTERVAL
- SLOPE PROFILE ALONG BRIDGE CENTERLINE FROM 2015 LIDAR

NOTES:

1. DATA CONCERNING THE VARIOUS STRATA HAVE BEEN OBTAINED AT THE TEST HOLE LOCATIONS ONLY. THE SOIL STRATIGRAPHY BETWEEN TEST HOLES HAS BEEN INFERRED FROM GEOLOGICAL EVIDENCE AND SO MAY VARY FROM THAT SHOWN.
2. TEST HOLE OFFSET VALUE IS MEASURED FROM THE CENTERLINE OF THE BRIDGE.



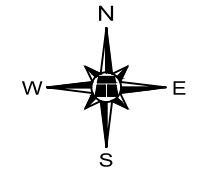
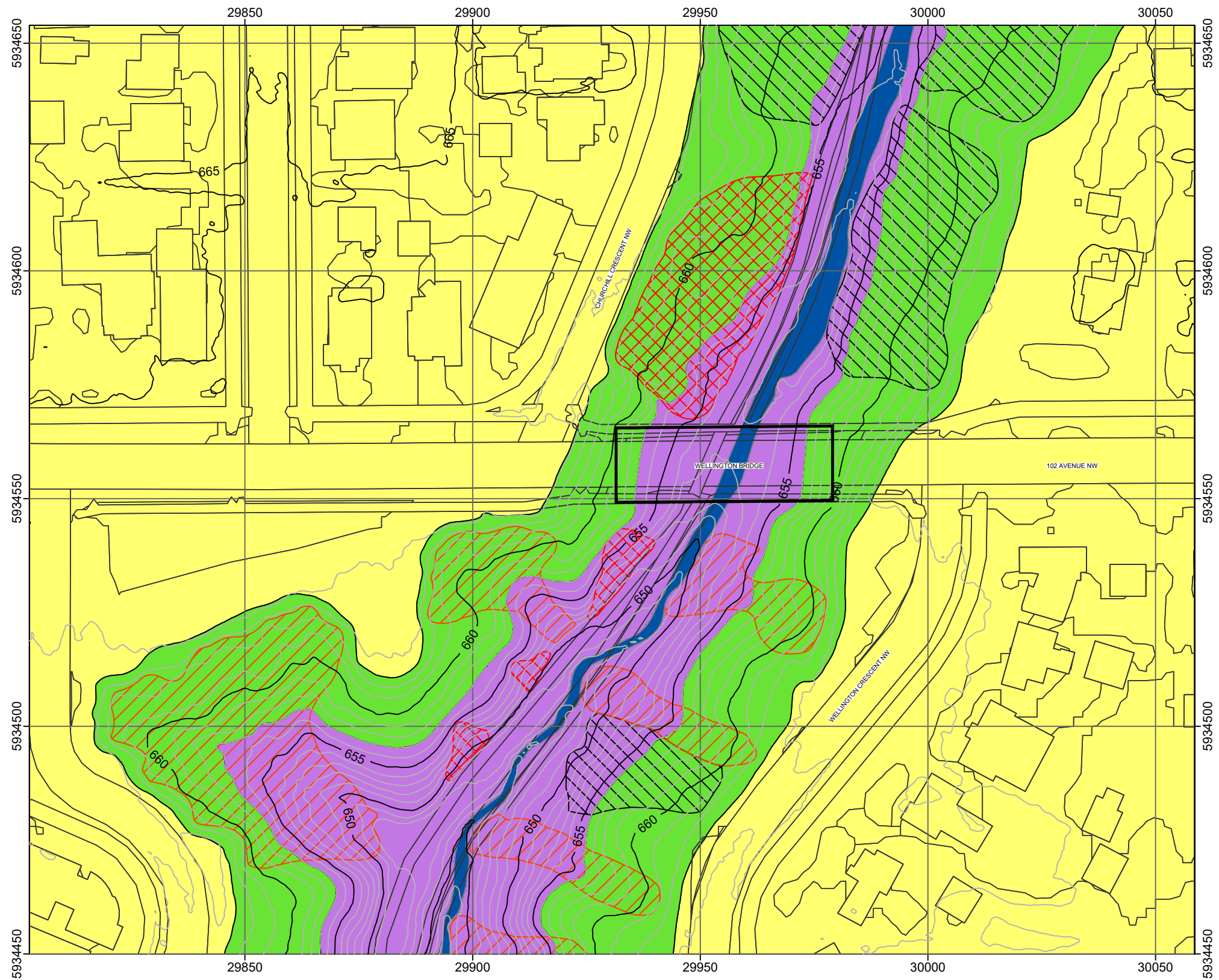
WELLINGTON BRIDGE REPLACEMENT

STRATIGRAPHIC CROSS - SECTION A - A'

DWG No. 28874-2

DRAWN BY	ML
DESIGNED BY	SEC
APPROVED BY	TSA
SCALE	1:400
DATE	FEBRUARY 2021
FILE No.	28874

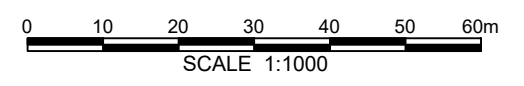





LEGEND

- GLACIOLACUSTRINE DEPOSITS: LAYERED SILT, SAND AND CLAY.
- COLLUVIUM: WEATHERED AND GRAVITATIONALLY MOVED GLACIOLACUSTRINE DEPOSITS. SLOPE UNDER SHALLOW GRADUAL, SEASONAL CREEP MOVEMENT.
- COLLUVIUM: WEATHERED AND GRAVITATIONALLY MOVED MIXTURE OF TILL AND GLACIOLACUSTRINE DEPOSITS COVERING GLACIAL TILL: MIXTURE OF CLAY, WITH WITH SOME SAND AND GRAVEL AND COBBLES.
- LANDSLIDES IN ADVANCE STAGE: CRACKS AND SLIDE SURFACE DEVELOPED. LANDSLIDES ARE IN DORMANT OR SLOW MOVEMENT CONDITION. POTENTIALLY ACTIVE LANDSLIDES.
- LANDSLIDES IN SLOW MUD FLOW FORM: GROUNDWATER DISCHARGING FROM LOWER PORTION OF GLACIOLACUSTRINE DEPOSITS AND SURFACE WATER IN WET AND MELTING SEASONS OVERSATURATED THE COLLUVIUM WHICH SLOWLY FLOW DOWNHILL.
- LANDSLIDE IN INITIAL STAGE: COLLUVIUM BULGING AND STARING TO CREATE FRACTURES. NOTE: ALL SLOPE MOVEMENTS ARE IN GENERAL SHALLOW SEASONAL, GRADUAL SLOPE MOVEMENT. TILL IS LESS DISTURBED THAN GLACIOFLUVIAL DEPOSITS BY SLOPE MOVEMENT.
- CREEK BED

REFERENCE:
 C. P. KATHOL AND R. A. MCPHERSON. URBAN GEOLOGY OF EDMONTON. BULLETIN 32. ALBERTA RESEARCH COUNCIL. 1975.






WELLINGTON BRIDGE REPLACEMENT

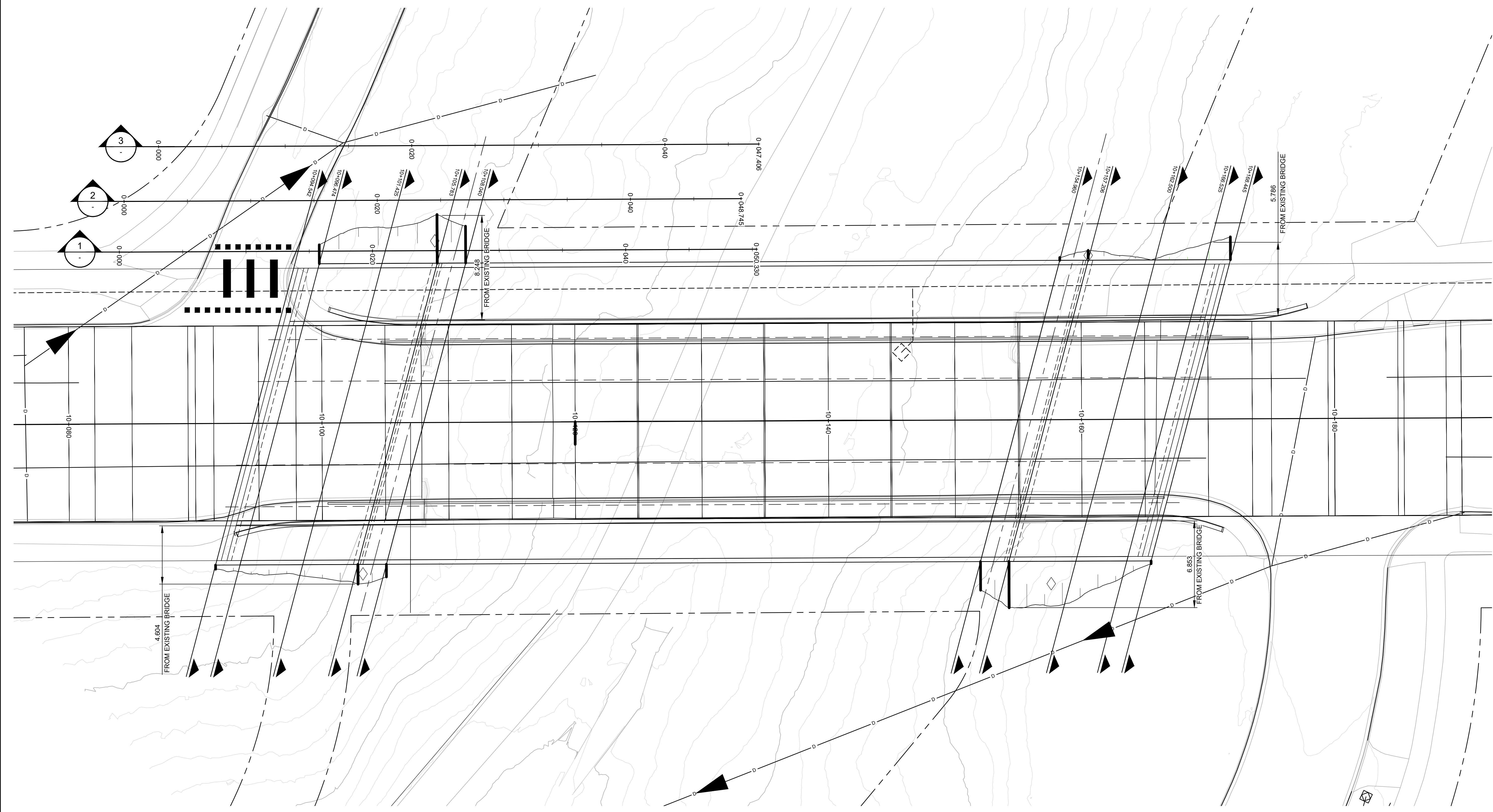
SURFICIAL GEOLOGY MAP

DWG No. 28874-3

DRAWN BY	ML
DESIGNED BY	SEC
APPROVED BY	TSA
SCALE	1:1000
DATE	FEBRUARY 2021
FILE No.	28874



THURBER ENGINEERING LTD.



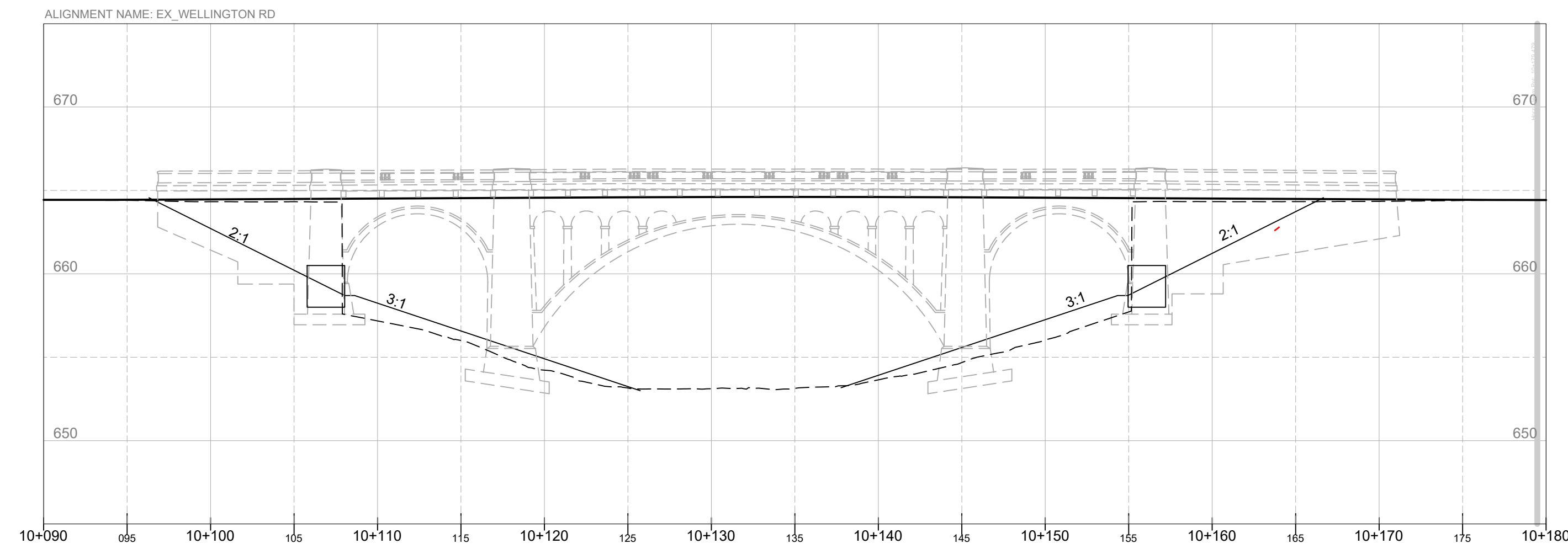
AE PROJECT No. 20203858-00
SCALE 1:150
APPROVED J. GAGNE
DATE 2020JANXX
REV
DESCRIPTION ISSUED FOR PRELIMINARY REVIEW

PRELIMINARY
 CITY OF EDMONTON

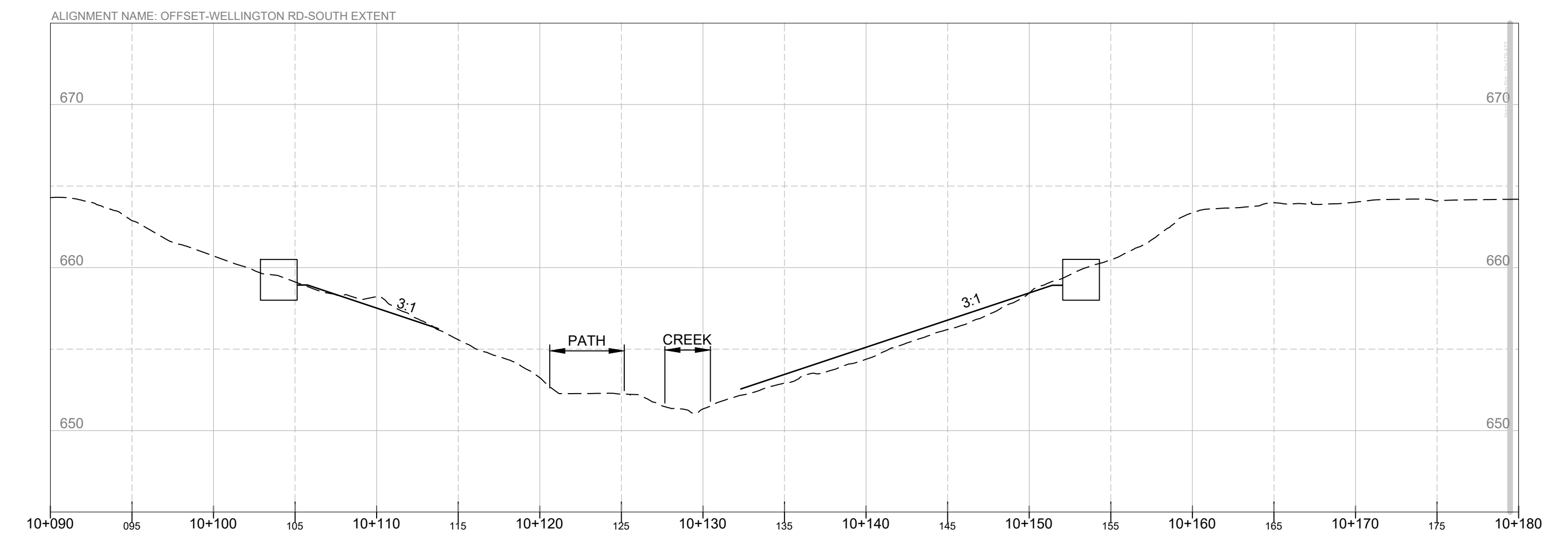
WELLINGTON BRIDGE REPLACEMENT
 SINGLE SPAN STEEL GIRDER BRIDGE
 PLAN

DWG No. SK-1A

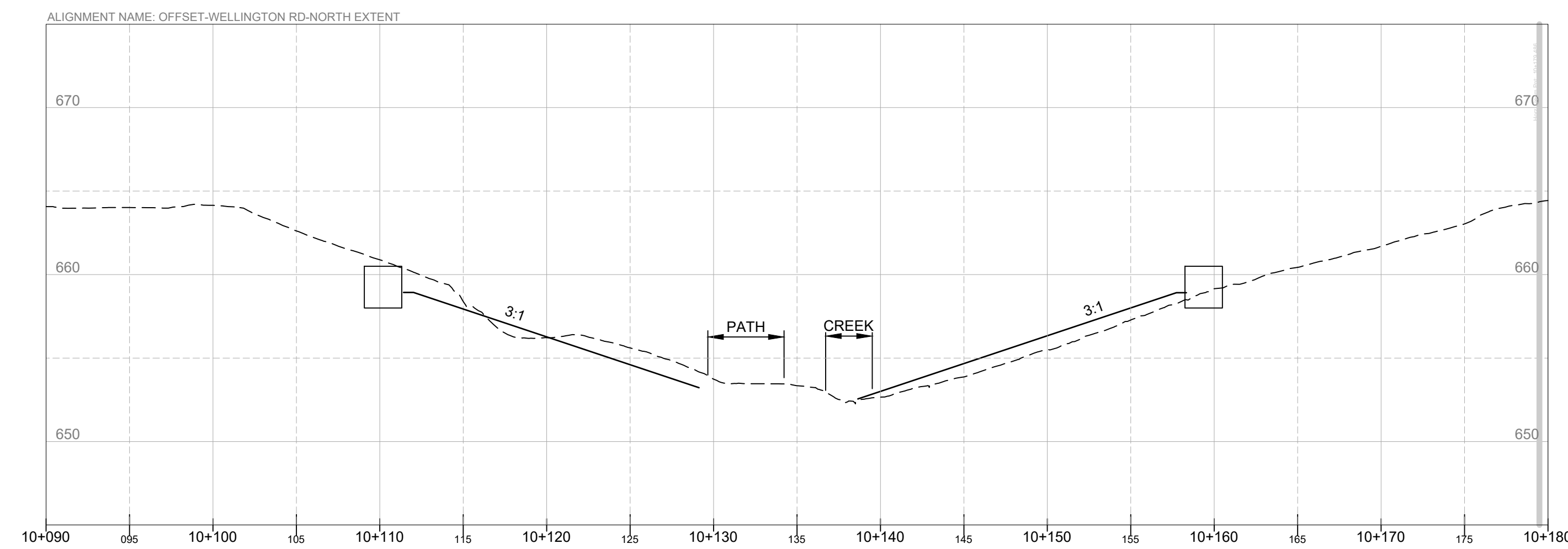
Ex_Wellington Rd SCALE 1:250



Offset-Wellington Rd-South Extent SCALE 1:250



Offset-Wellington Rd-North Extent SCALE 1:250



Platinum member

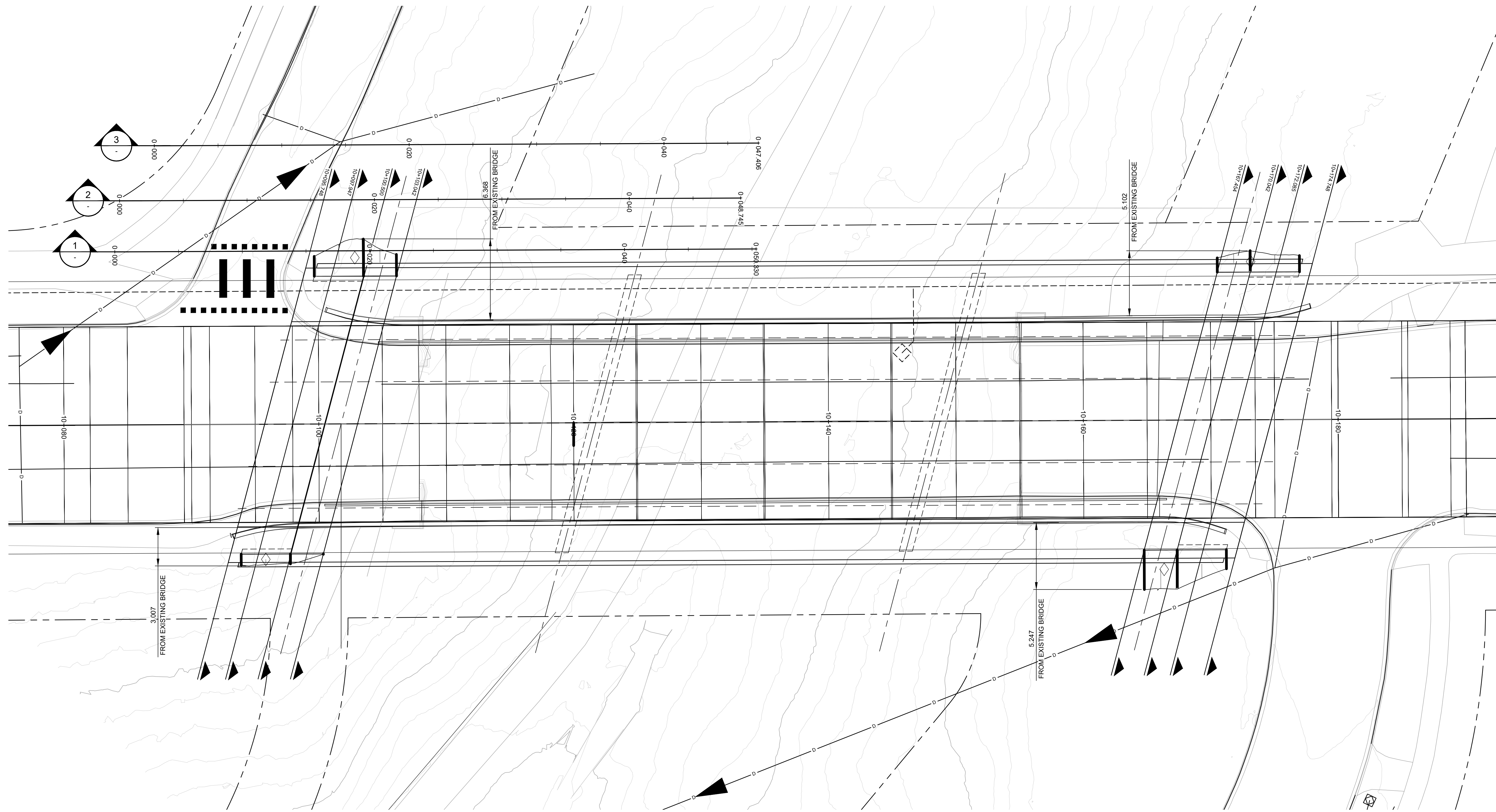
AE PROJECT No. 20203858-00
SCALE 1:250
APPROVED J. GAGNE
DATE 2020JANXX
REV
DESCRIPTION ISSUED FOR PRELIMINARY REVIEW

PRELIMINARY
CITY OF EDMONTON

WELLINGTON BRIDGE REPLACEMENT
SINGLE SPAN STEEL GIRDER BRIDGE
SECTIONS

DWG No.

SK-1B



Platinum member

AE PROJECT No.	20203858-00
SCALE	1:150
APPROVED	J. GAGNE
DATE	2020JANXX
REV	
DESCRIPTION	ISSUED FOR PRELIMINARY REVIEW

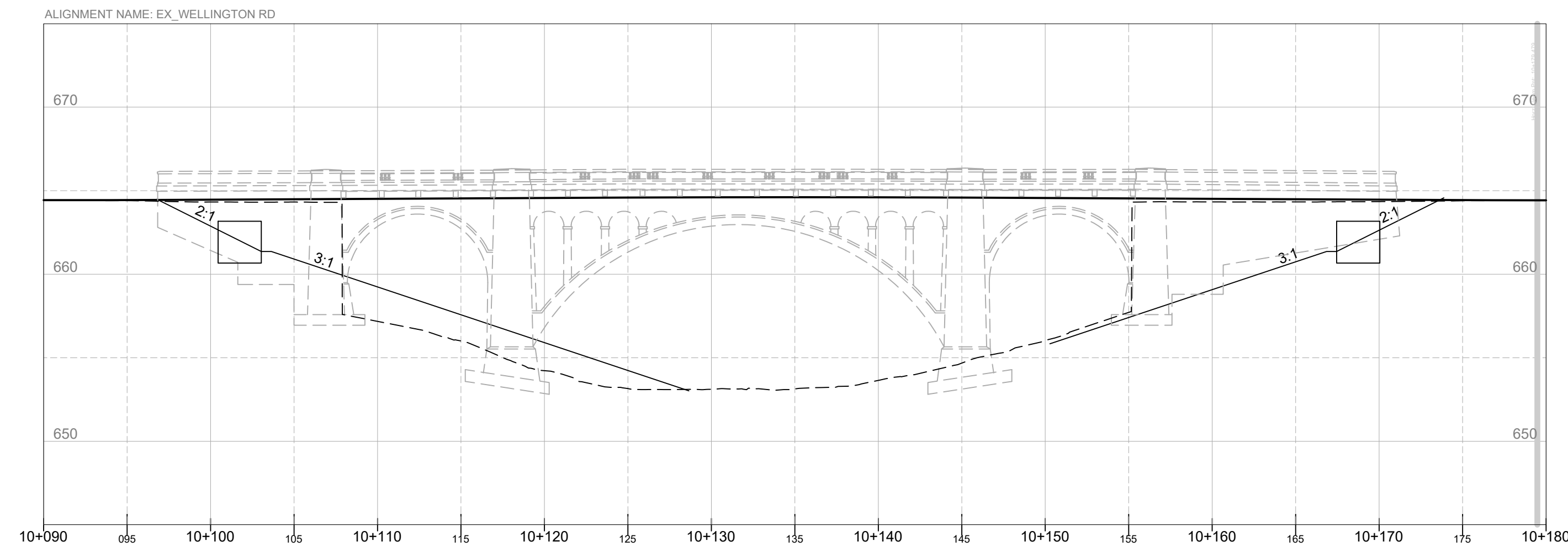
PRELIMINARY
CITY OF EDMONTON

WELLINGTON BRIDGE REPLACEMENT
THREE SPAN HAUNCHED CONCRETE DECK SLAB
PLAN

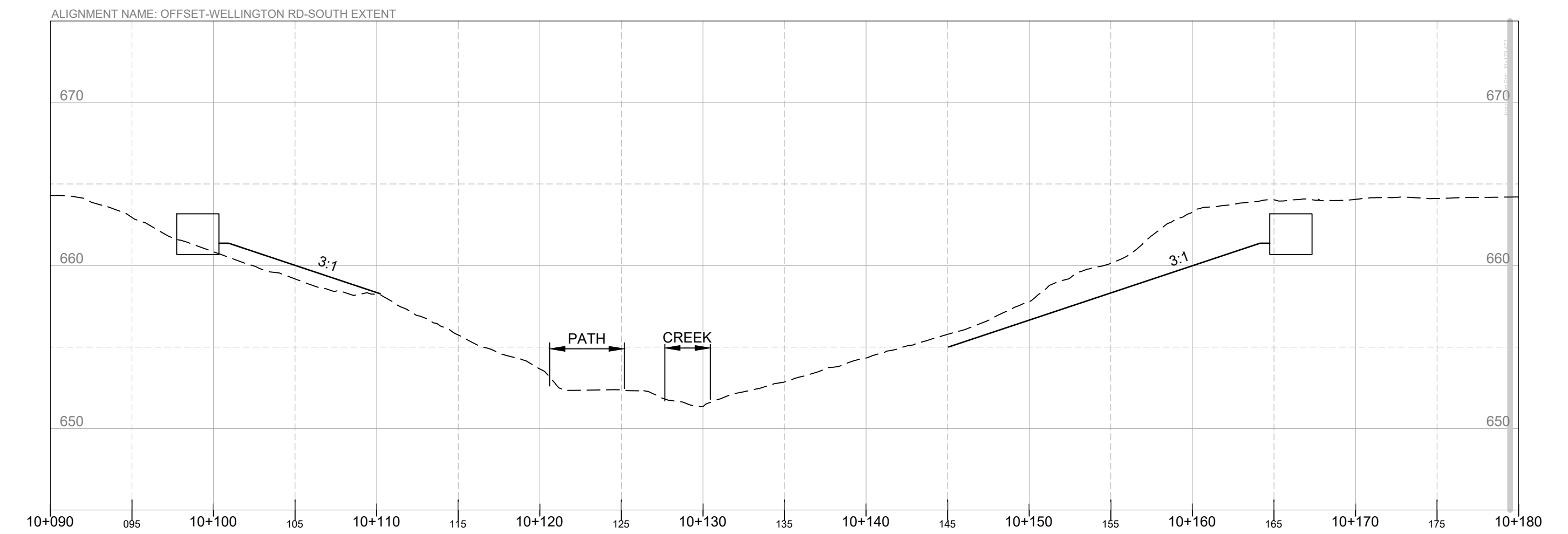
DWG No.

SK-2A

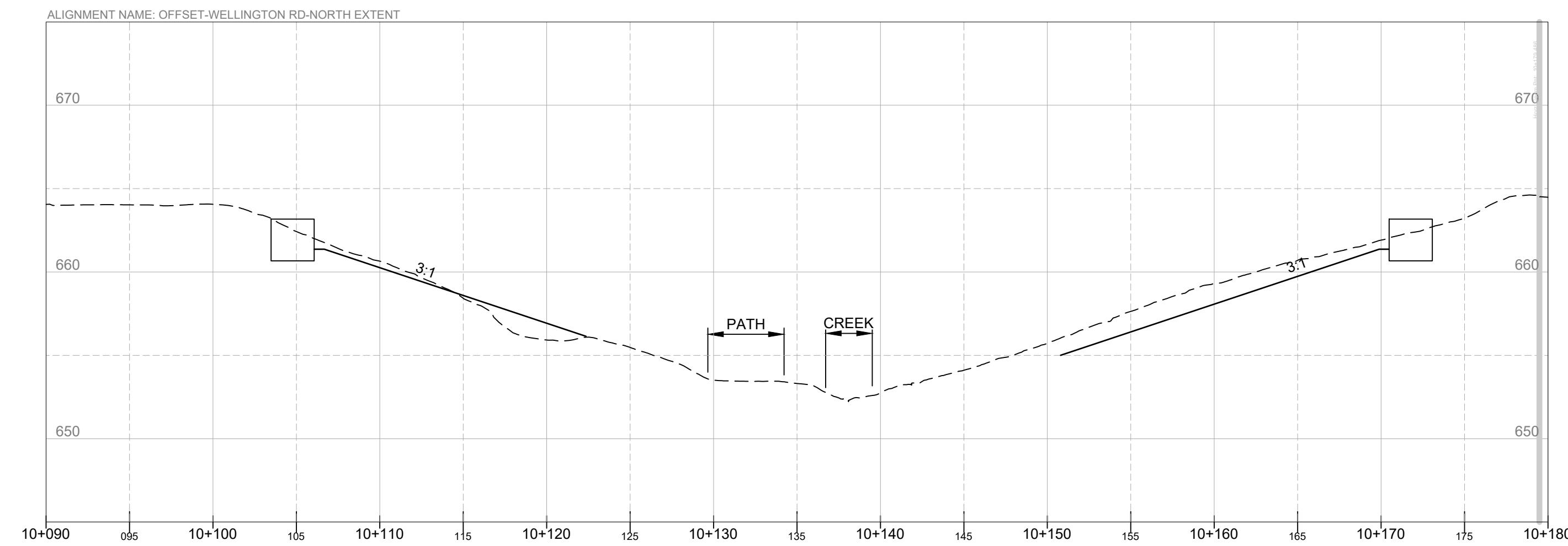
Ex_Wellington Rd SCALE 1:250



Offset-Wellington Rd-South Extent SCALE 1:250



Offset-Wellington Rd-North Extent SCALE 1:250



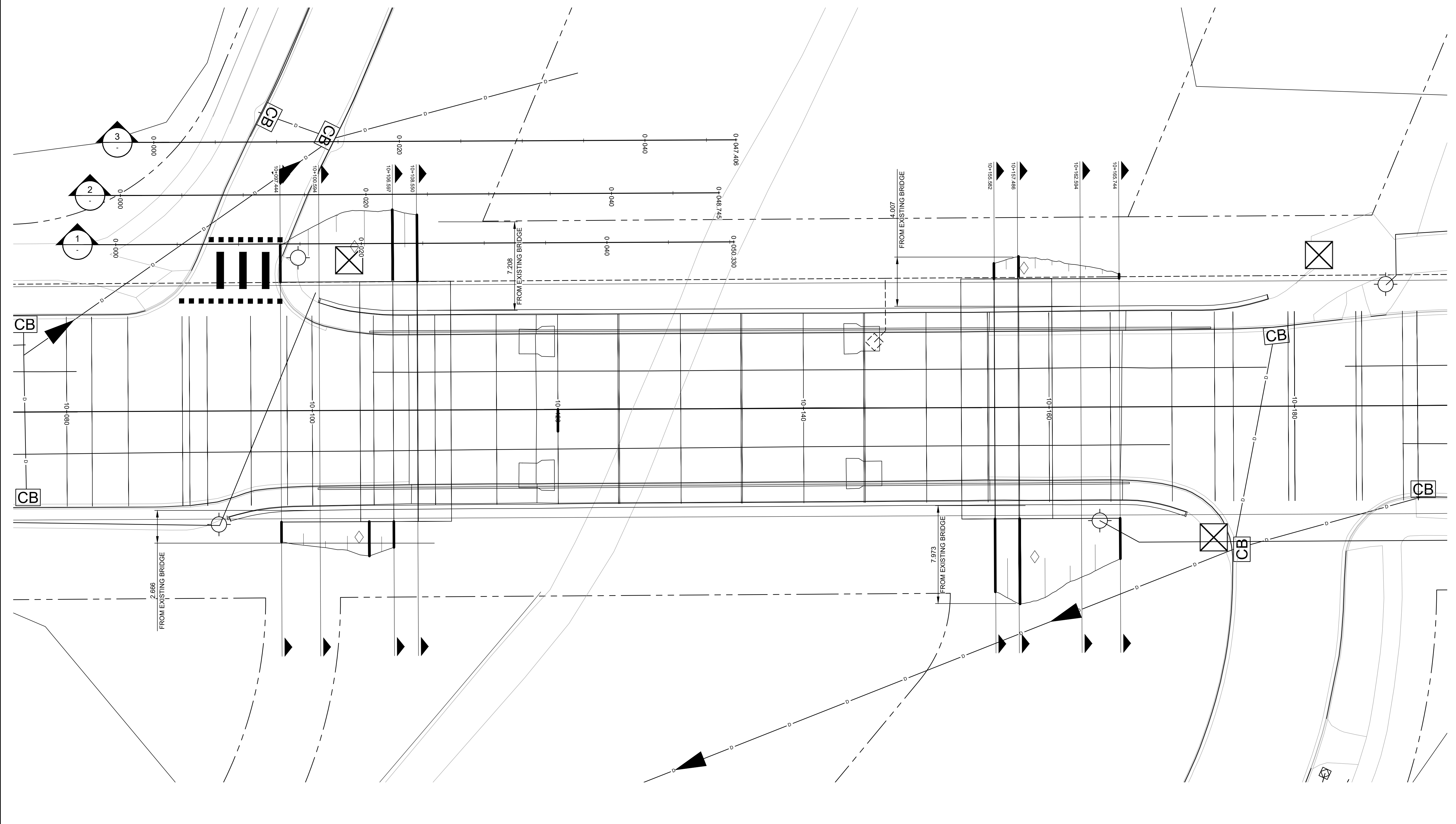
AE PROJECT No. 20203858-00
SCALE 1:250
APPROVED J. GAGNE
DATE 2020JANXX
REV
DESCRIPTION ISSUED FOR PRELIMINARY REVIEW

PRELIMINARY
 CITY OF EDMONTON

WELLINGTON BRIDGE REPLACEMENT
 THREE SPAN HAUNCHED CONCRETE DECK SLAB
 SECTIONS

DWG No.

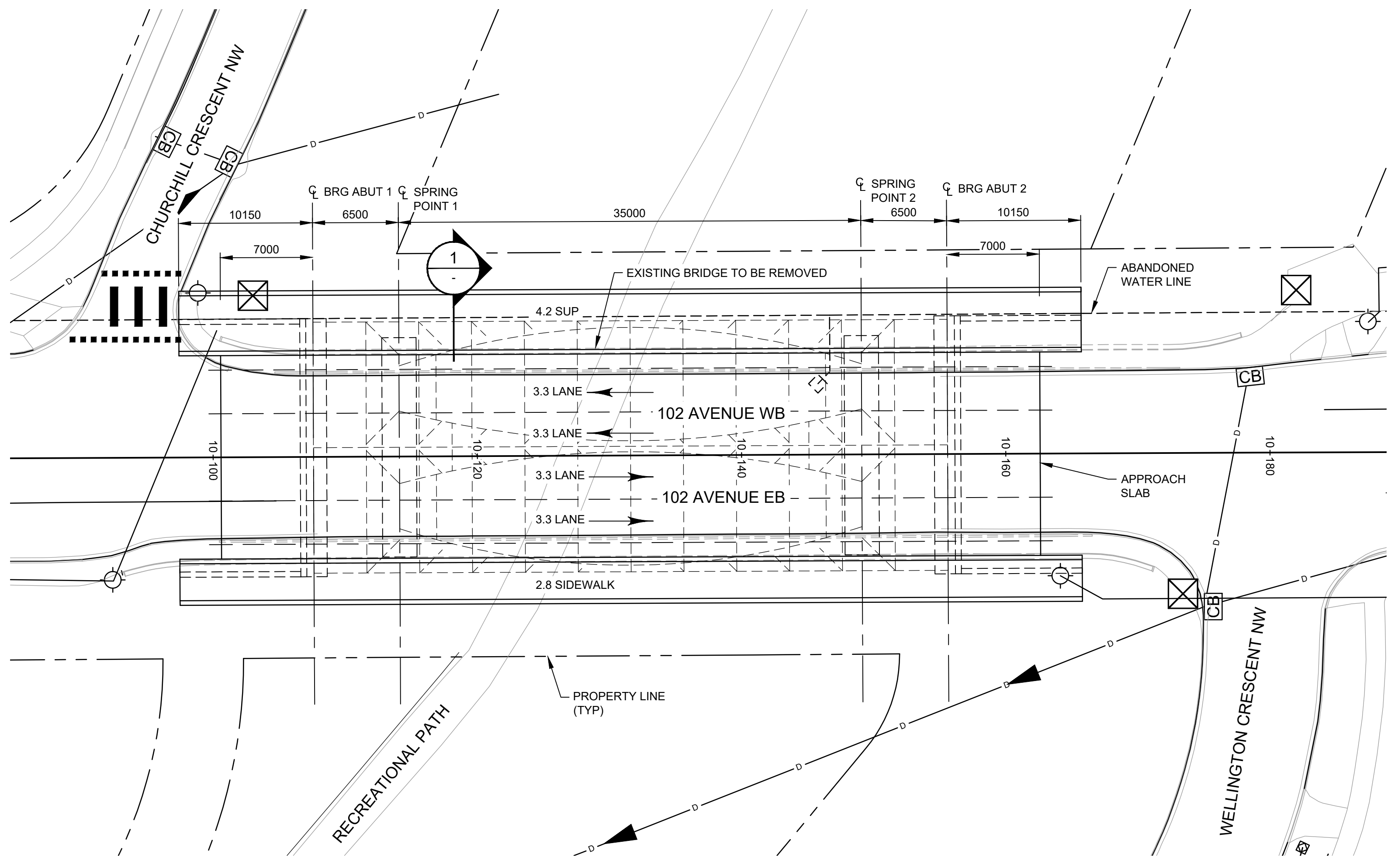
SK-2B



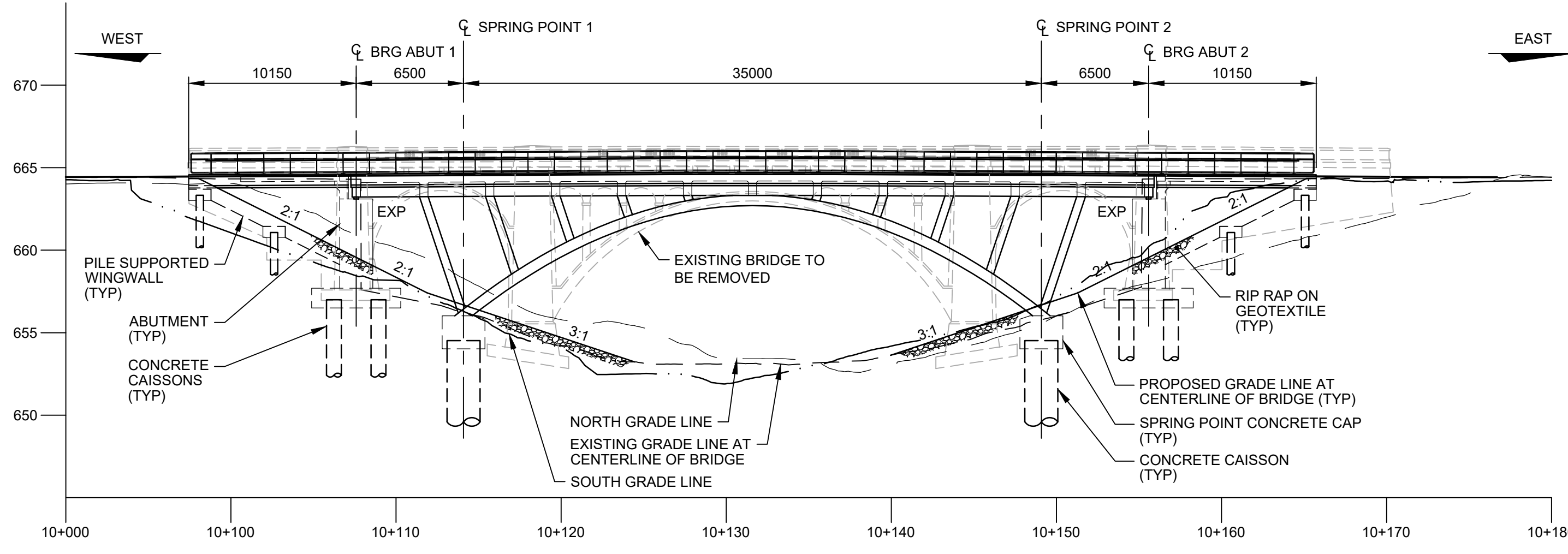
Platinum member

AE PROJECT No.	20203858-00
SCALE	1:150
APPROVED	J. GAGNE
DATE	2020JANXX
REV	
DESCRIPTION	ISSUED FOR PRELIMINARY REVIEW

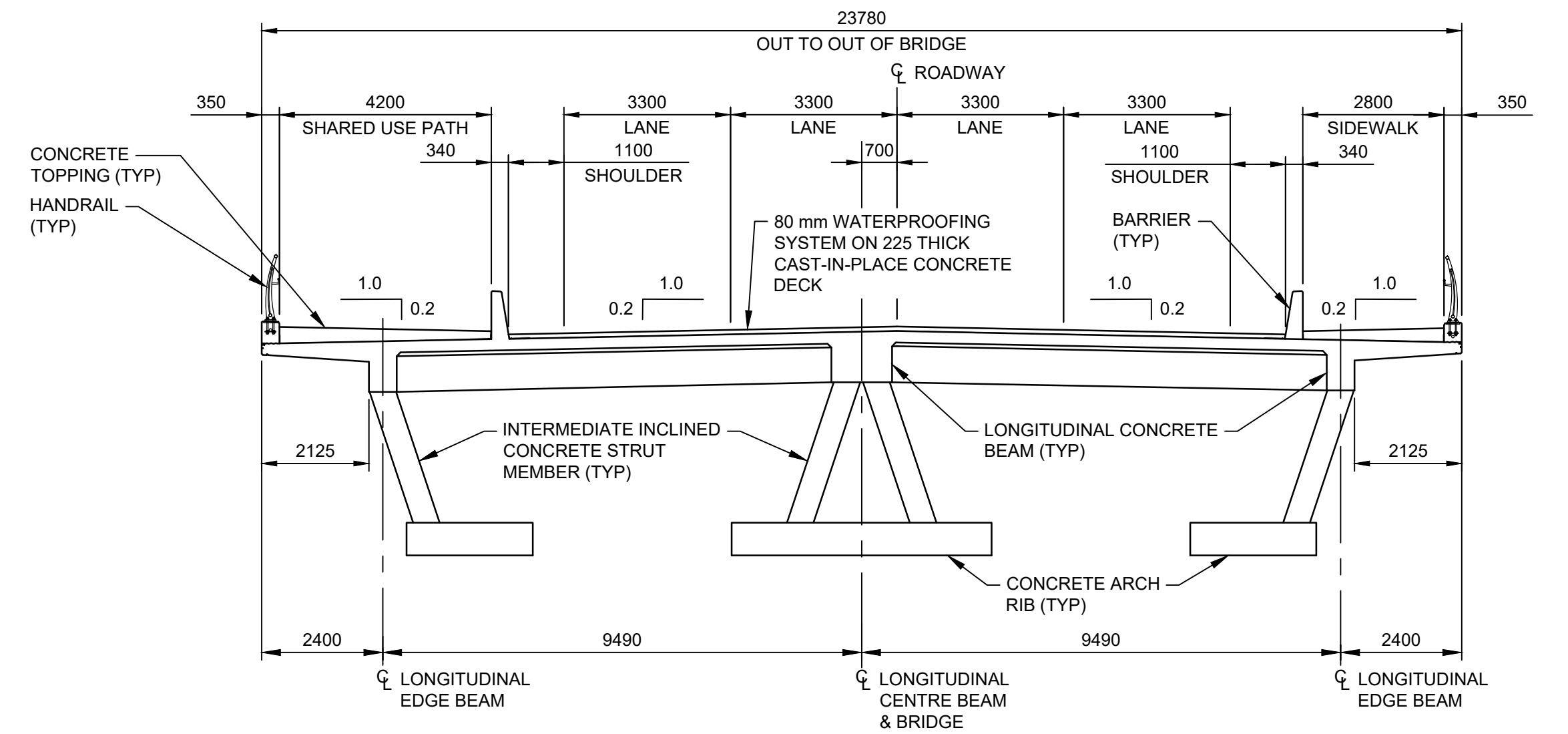
PRELIMINARY
CITY OF EDMONTON
WELLINGTON BRIDGE REPLACEMENT MODERN ARCH PLAN
DWG No. SK-3A



PLAN 1:250



ELEVATION 1:250
LOOKING NORTH



SECTION 1:100
LOOKING EAST

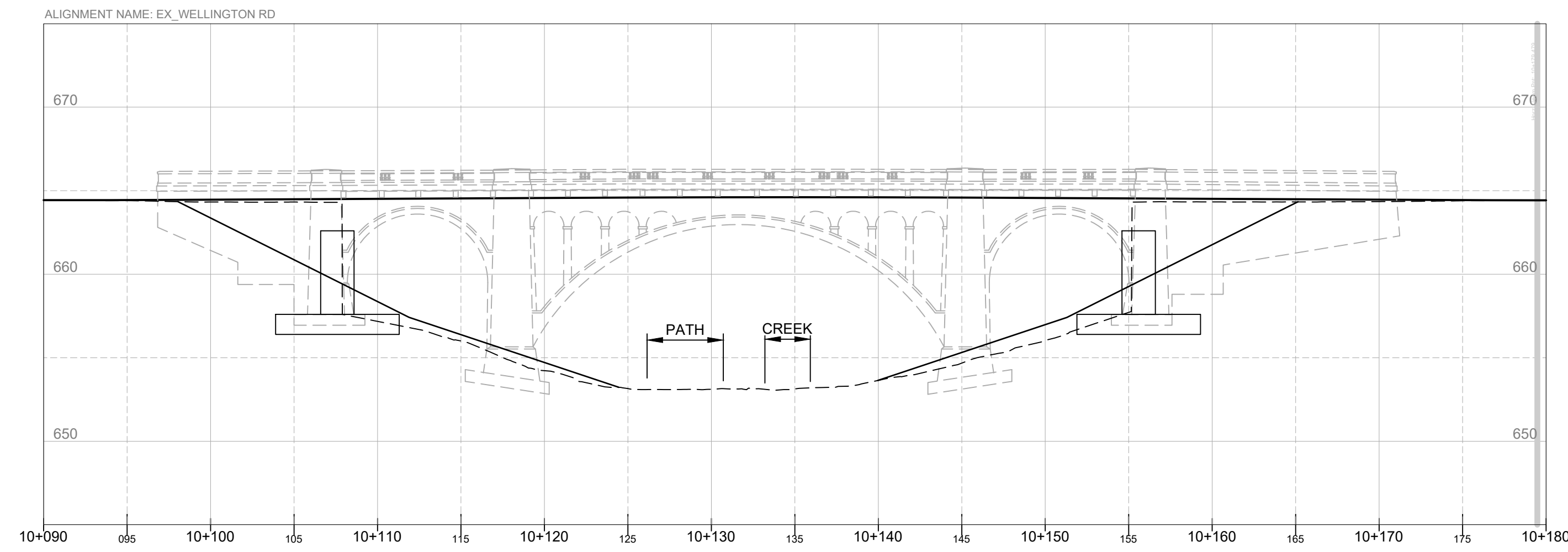
PLOT DATE: 1/20/2021 10:33:19 AM
SAVE DATE: 1/20/2021 8:33:41 AM
SAVED BY: KIRK
DWG PATH: \\s-edi-hs-01\working\2020\3858-00\distru\modern arch.dwg



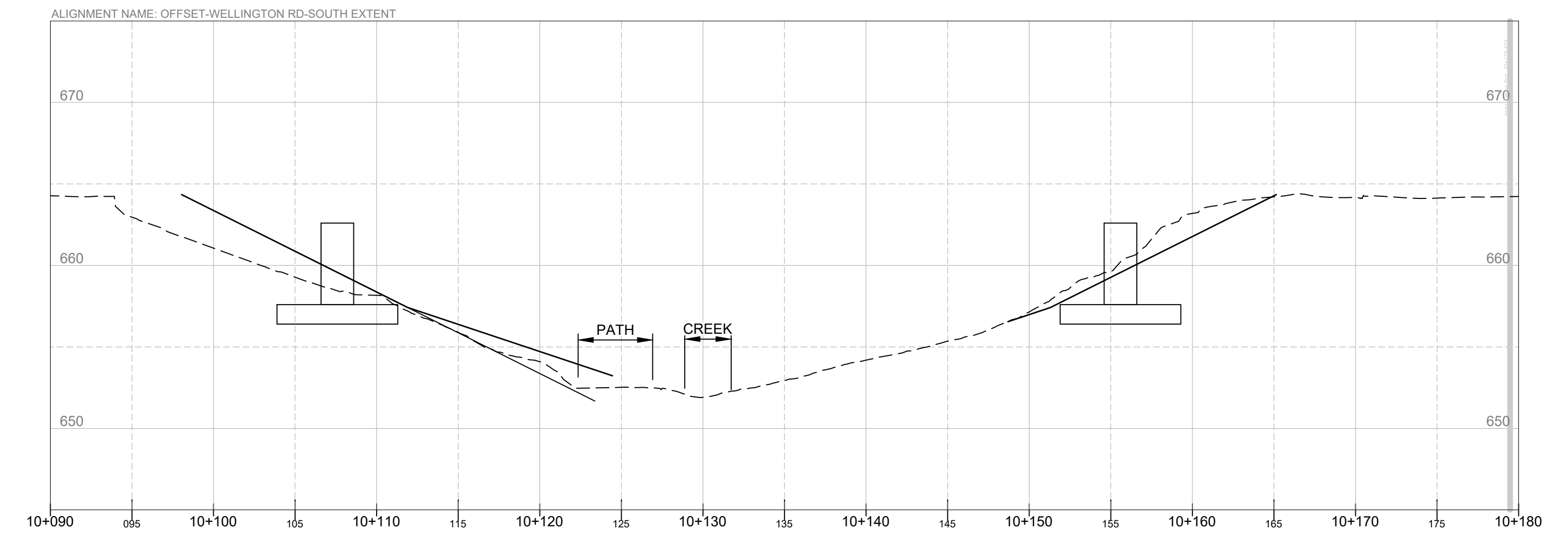
AE PROJECT No.	20203858-00
SCALE	AS SHOWN
APPROVED	J. GAGNE
DATE	2020JANXX
REV	
DESCRIPTION	ISSUED FOR PRELIMINARY REVIEW

PRELIMINARY
CITY OF EDMONTON
WELLINGTON BRIDGE REPLACEMENT
MODERN ARCH
GENERAL LAYOUT

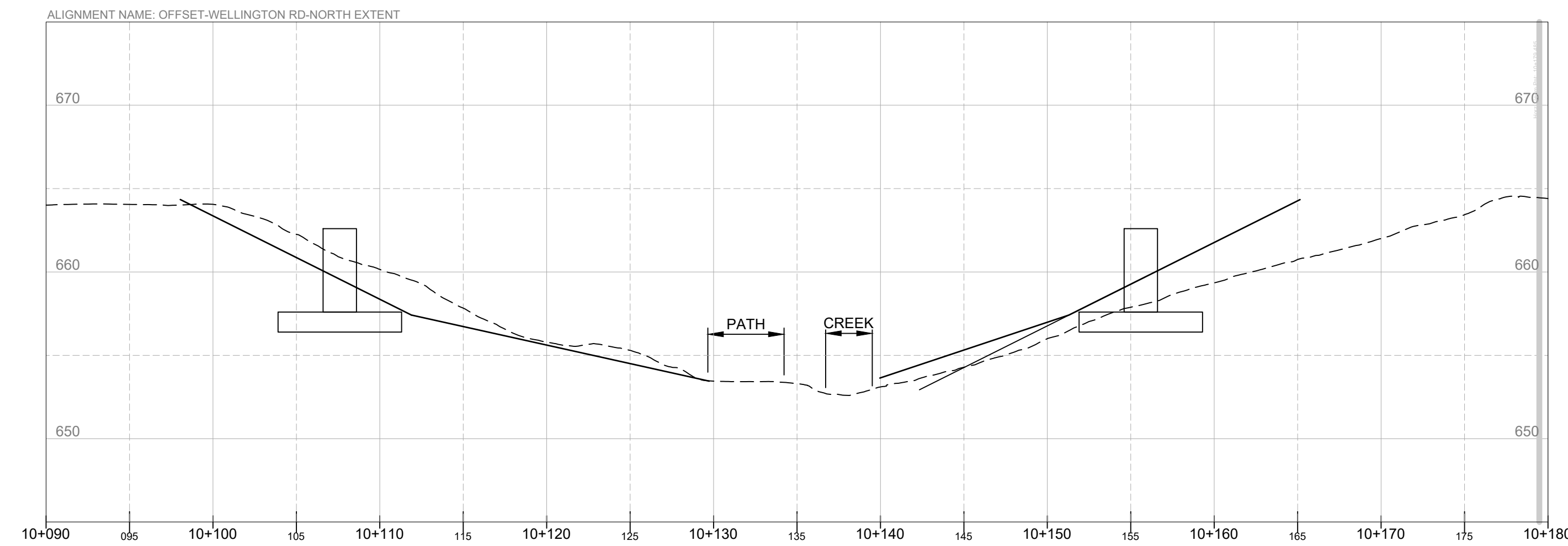
Ex_Wellington Rd SCALE 1:250



Offset-Wellington Rd-South Extent SCALE 1:250



Offset-Wellington Rd-North Extent SCALE 1:250



AE PROJECT No. 20203858-00
 SCALE 1:250
 APPROVED J. GAGNE
 DATE 2020JANXX
 REV
 DESCRIPTION ISSUED FOR PRELIMINARY REVIEW

PRELIMINARY
 CITY OF EDMONTON

WELLINGTON BRIDGE REPLACEMENT
 MODERN ARCH
 SECTIONS

DWG No.

SK-3B



APPENDIX B

Selected Site Photographs



PHOTO 1 CATCH BASIN AND CRACKING ON CHURCHILL CRESCENT LOOKING SOUTH TOWARDS 102 AVENUE



PHOTO 2 TIMBER RETAINING WALL ALONG WEST SIDE OF MULT-USE TRAIL TOWARDS SOUTH

WELLINGTON BRIDGE REPLACEMENT

SELECTED SITE PHOTOGRAPHS

PLATE 1



DRAWN BY	ML
DESIGNED BY	SEC
APPROVED BY	TSA
SCALE	N.T.S.
DATE	NOVEMBER 2020
FILE No.	28874





PHOTO 3 SOUTH END OF TIMBER RETAINING WALL NORTH OF BRIDGE



PHOTO 4 SURFACE CRACKING ON MULTI-USE TRAIL BETWEEN RETAINING WALL AND BRIDGE

WELLINGTON BRIDGE REPLACEMENT

SELECTED SITE PHOTOGRAPHS

PLATE 2



DRAWN BY	ML
DESIGNED BY	SEC
APPROVED BY	TSA
SCALE	N.T.S.
DATE	NOVEMBER 2020
FILE No.	28874



THURBER ENGINEERING LTD.



PHOTO 5 OUTFALL ON EAST SIDE OF MULTI-USE TRAIL FROM CHURCHILL CRESCENT



PHOTO 6 EROSION ON WEST RAVINE SLOPE NORTH OF BRIDGE

WELLINGTON BRIDGE REPLACEMENT

SELECTED SITE PHOTOGRAPHS

PLATE 3



DRAWN BY	ML
DESIGNED BY	SEC
APPROVED BY	TSA
SCALE	N.T.S.
DATE	NOVEMBER 2020
FILE No.	28874



THURBER ENGINEERING LTD.



PHOTO 7 EROSION ON WEST RAVINE SLOPE NORTH OF BRIDGE



PHOTO 8 EROSION ON WEST RAVINE SLOPE NORTH OF BRIDGE

WELLINGTON BRIDGE REPLACEMENT

SELECTED SITE PHOTOGRAPHS

PLATE 4



DRAWN BY	ML
DESIGNED BY	SEC
APPROVED BY	TSA
SCALE	N.T.S.
DATE	NOVEMBER 2020
FILE No.	28874



THURBER ENGINEERING LTD.



PHOTO 9 DIAGONAL CRACKING ON 102 AVENUE IN WEST ABUTMENT AREA



PHOTO 10 EROSION ON EAST RAVINE SLOPE NORTH OF BRIDGE

WELLINGTON BRIDGE REPLACEMENT

SELECTED SITE PHOTOGRAPHS

PLATE 5



DRAWN BY	ML
DESIGNED BY	SEC
APPROVED BY	TSA
SCALE	N.T.S.
DATE	NOVEMBER 2020
FILE No.	28874



THURBER ENGINEERING LTD.



PHOTO 11 DRAINAGE CHANNEL DISTURBANCE EAST OF MULTI-USE PATH SOUTH OF BRIDGE



PHOTO 12 OUTFALL ON EAST RAVINE SLOPE SOUTH OF BRIDGE

WELLINGTON BRIDGE REPLACEMENT

SELECTED SITE PHOTOGRAPHS

PLATE 6



DRAWN BY	ML
DESIGNED BY	SEC
APPROVED BY	TSA
SCALE	N.T.S.
DATE	NOVEMBER 2020
FILE No.	28874



THURBER ENGINEERING LTD.



APPENDIX C

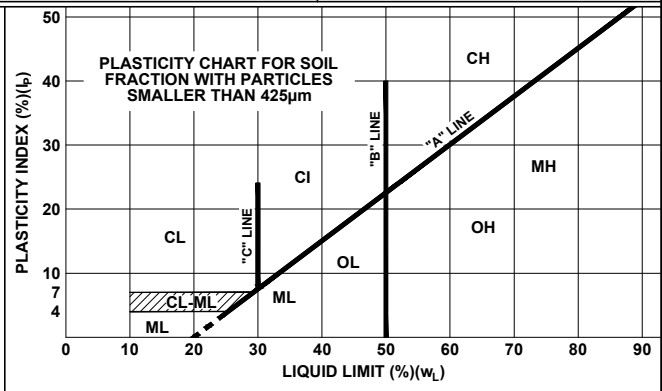
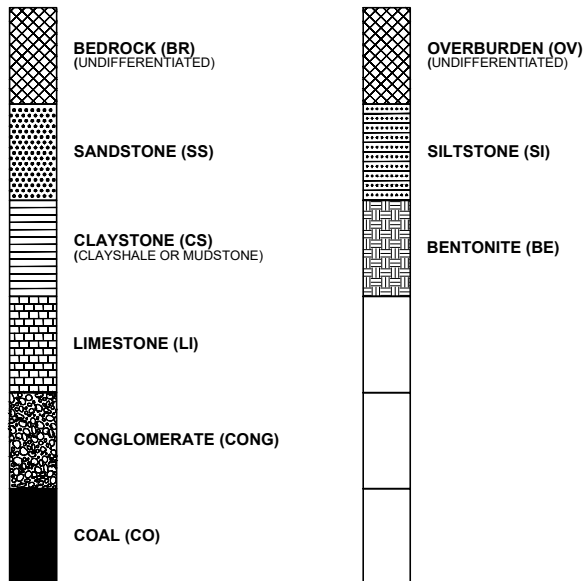
Modified Unified Soils Classification System
Symbols and Terms Used on the Test Hole Logs
Current Test Hole Logs (TH20-1 to TH20-5)
Previous Test Hole Logs (TH14-1 to TH14-2)

MODIFIED UNIFIED CLASSIFICATION SYSTEM FOR SOILS

(MODIFIED BY PFRA, 1985)

MAJOR DIVISION		GROUP SYMBOL	THURBER LOG SYMBOL	TYPICAL DESCRIPTION	LABORATORY CLASSIFICATION CRITERIA			
COARSE-GRAINED SOILS (MORE THAN HALF BY WEIGHT LARGER THAN 75µm)	GRAVELS MORE THAN HALF COARSE GRAINS LARGER THAN 4.75mm	GW	▲ ▼ ▲ ▲ ▼ ▲ ▲ ▼ ▲	WELL GRADED GRAVELS, GRAVEL-SAND MIXTURES, LITTLE OR NO FINES	$C_u = \frac{D_{60}}{D_{10}} > 4; C_c = \frac{(D_{30})^2}{D_{10} \times D_{60}} = 1 \text{ to } 3$ NOT MEETING ALL GRADATION REQUIREMENTS FOR GW ATTERBERG LIMITS BELOW "A" LINE I_p LESS THAN 4 ATTERBERG LIMITS ABOVE "A" LINE I_p MORE THAN 7 $C_u = \frac{D_{60}}{D_{10}} > 6; C_c = \frac{(D_{30})^2}{D_{10} \times D_{60}} = 1 \text{ to } 3$ NOT MEETING ALL GRADATION REQUIREMENTS FOR SW ATTERBERG LIMITS BELOW "A" LINE I_p LESS THAN 4 ATTERBERG LIMITS ABOVE "A" LINE I_p MORE THAN 7			
		GP	▲ ▲ ▲ ▲ ▲ ▲ ▲ ▲ ▲	POORLY GRADED GRAVELS, GRAVEL-SAND MIXTURES, LITTLE OR NO FINES				
		GRAVELS WITH FINES (APPRECIABLE AMOUNT OF FINES)	GM	▲ ▲ ▲ ▲ ▲ ▲ ▲ ▲ ▲		SILTY GRAVELS, GRAVEL-SAND-SILT MIXTURES		
			GC	▲ ▲ ▲ ▲ ▲ ▲ ▲ ▲ ▲		CLAYEY GRAVELS, GRAVEL-SAND-CLAY MIXTURES		
	SANDS MORE THAN HALF COARSE GRAINS SMALLER THAN 4.75mm	SW	● ● ● ● ● ● ● ● ●	WELL GRADED SANDS, GRAVELLY-SANDS, LITTLE OR NO FINES				
		SP	○ ○ ○ ○ ○ ○ ○ ○ ○	POORLY GRADED SANDS, GRAVELLY SANDS, LITTLE OR NO FINES				
		SAND WITH FINES (APPRECIABLE AMOUNT OF FINES)	SM	○ ○ ○ ○ ○ ○ ○ ○ ○		SILTY SANDS, SAND-SILT MIXTURES		
			SC	○ ○ ○ ○ ○ ○ ○ ○ ○		CLAYEY SANDS, SAND-CLAY MIXTURES		
		FINE-GRAINED SOILS (MORE THAN HALF BY WEIGHT SMALLER THAN 75µm)	SILTS BELOW "A" LINE NEGLIGIBLE ORGANIC CONTENT	$w_L < 50\%$		ML	INORGANIC SILTS AND VERY FINE SANDS, ROCK FLOUR, SILTY OR CLAYEY FINE SANDS OR CLAYEY SILTS WITH SLIGHT PLASTICITY	CLASSIFICATION IS BASED UPON PLASTICITY CHART (see below)
				$w_L > 50\%$		MH	INORGANIC SILTS, MICACEOUS OR DIATOMACEOUS, FINE SANDY OR SILTY SOILS	
CLAYS ABOVE "A" LINE NEGLIGIBLE ORGANIC CONTENT	$w_L < 30\%$		CL	INORGANIC CLAYS OF LOW PLASTICITY, GRAVELLY, SANDY, OR SILTY CLAYS, LEAN CLAYS				
	$30\% < w_L < 50\%$		CI	INORGANIC CLAYS OF MEDIUM PLASTICITY, GRAVELLY CLAYS, SANDY CLAYS, SILTY CLAYS				
	$w_L > 50\%$		CH	INORGANIC CLAYS OF HIGH PLASTICITY, FAT CLAYS				
ORGANIC SILTS & CLAYS BELOW "A" LINE	$w_L < 50\%$		OL	ORGANIC SILTS AND ORGANIC SILTY CLAYS OF LOW AND MEDIUM PLASTICITY				
	$w_L > 50\%$	OH	ORGANIC CLAYS OF HIGH PLASTICITY, ORGANIC SILTS					
HIGHLY ORGANIC SOILS		Pt	PEAT AND OTHER HIGHLY ORGANIC SOILS	STRONG COLOR OR ODOR, AND OFTEN FIBROUS TEXTURE				

Determine percentages of gravel and sand from grain size curve. Depending on percentages of fines (fraction smaller than 75µm) coarse grained soils are classified as follows:
 Less than 5% GW, GP, SW, SP
 More than 5% GM, GC, SM, SC
 Borderline cases requiring use of dual symbols 5% to 12%



MODIFIED UNIFIED CLASSIFICATION SYSTEM FOR SOILS

(MODIFIED BY PFRA, 1985)

SYMBOLS AND TERMS USED ON TEST HOLE LOGS

1. VISUAL TEXTURAL CLASSIFICATION OF MINERAL SOILS

<u>CLASSIFICATION</u>	<u>APPARENT PARTICLE SIZE</u>	<u>VISUAL IDENTIFICATION</u>
Boulders	Greater than 200 mm	Greater than 200 mm
Cobbles	75 mm to 200 mm	75 mm to 200 mm
Gravel	4.75 mm to 75 mm	5 mm to 75 mm
Sand	0.075 mm to 4.75 mm	Visible particles to 5 mm
Silt	0.002 mm to 0.075 mm	Non-Plastic particles, not visible to the naked eye
Clay	Less than 0.002 mm	Plastic particles, not visible to the naked eye

2. TERMS DESCRIBING CONSISTENCY (COHESIVE SOILS ONLY)

<u>DESCRIPTIVE TERM</u>	<u>APPROXIMATE UNDRAINED SHEAR STRENGTH</u>	<u>APPROXIMATE SPT * 'N' VALUE</u>
Very Soft	Less than 10 kPa	Less than 2
Soft	10 - 25 kPa	2 to 4
Firm	25 - 50 kPa	4 to 8
Stiff	50 - 100 kPa	8 to 15
Very Stiff	100 - 200 kPa	15 to 30
Hard	200 - 300 kPa	Greater than 30
Very Hard	Greater than 300 kPa	

} Modified from National Building Code

* SPT 'N' Value Standard Penetration Test 'N' Value - refers to the number of blows from a 63.5 kg hammer free falling a height of 0.76m to advance a standard 50mm outside diameter split spoon sampler for 0.3m depth into the undrilled portion of the test hole.







3. TERMS DESCRIBING DENSITY (COHESIONLESS SOILS ONLY)

<u>DESCRIPTIVE TERM</u>	<u>STANDARD PENETRATION TEST (SPT) (Number of Blows per 300 mm)</u>
Very Loose	0 - 4
Loose	4 - 10
Compact	10 - 30
Dense	30 - 50
Very Dense	Over 50

} Modified from National Building Code

4. LEGEND FOR TEST HOLE LOGS

SYMBOL FOR SAMPLE TYPE

 Shelby Tube	 SPT	 No Recovery	 A-Casing	 Grab	 Core
---	---	---	--	--	--

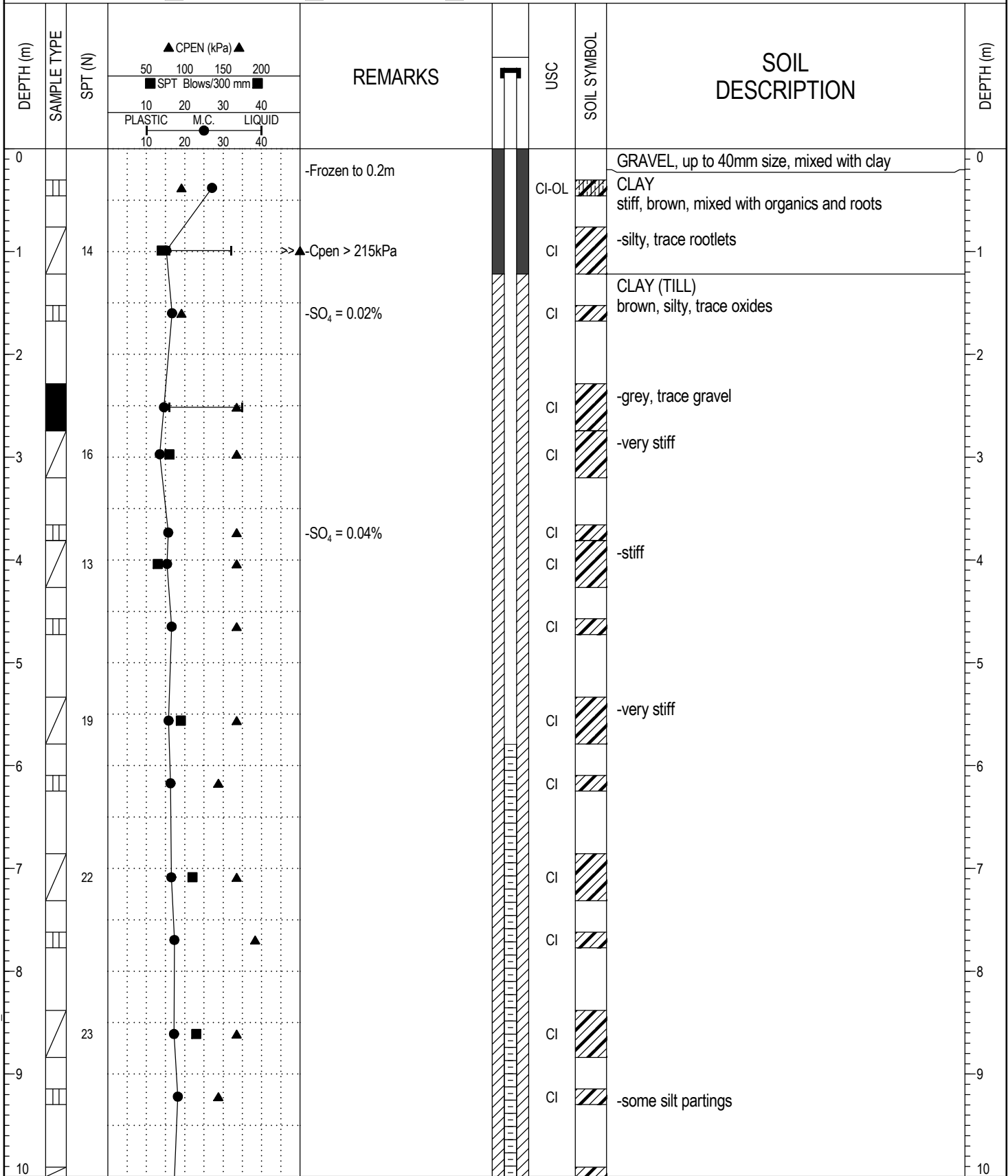
SYMBOLS USED FOR TEST HOLE LOGS

●	WC - Water Content (% by weight) of soil sample
▼	Water Level
■	SPT Standard Penetration Test 'N' Value (Blows/300mm)
▲	CPen Shear Strength determined by pocket penetrometer
CVane	Shear Strength determined by pocket vane
Cu	Undrained Shear Strength determined by unconfined compression test
SO ₄ %	Percent (%) of water soluble sulphate ions

TERMS DESCRIBING QUANTITIES

'and'	35% to 50% of each size group
'sandy'	20% to 35%
'some'	10% to 20%
'trace'	Less than 10%
'mixture'	Soils containing three or more size groups within 20% of each other and each group greater than 10%

CLIENT: CH2M HILL CANADA LTD	PROJECT: WELLINGTON BRIDGE ASSESSMENT	BOREHOLE NO: TH14-1
DRILLING COMPANY: Mobile Augers & Research Ltd.	DATE DRILLED: January 20, 2014	PROJECT NO: 17-834-167
DRILL/METHOD: M5 Track / Solid Stem Augers	LOCATION: See Drawing #17-834-167-1	ELEVATION:
SAMPLE TYPE	<input type="checkbox"/> GRAB SAMPLE <input checked="" type="checkbox"/> SPT <input checked="" type="checkbox"/> SHELBY TUBE	
BACKFILL TYPE	<input checked="" type="checkbox"/> BENTONITE <input checked="" type="checkbox"/> DRILL CUTTINGS <input type="checkbox"/> SLOUGH	



BOREHOLE LOG 17-834-167.GPJ, THRR-AB.GDT, 20-12-14-LIBRARY-NEW.LOGO.GLB



FIELD LOGGED BY: YCL	COMPLETION DEPTH: 10.4 m
PREPARED BY: SEC	COMPLETION DATE: 14-1-20
REVIEWED BY: TSA	

CLIENT: CH2M HILL CANADA LTD	PROJECT: WELLINGTON BRIDGE ASSESSMENT	BOREHOLE NO: TH14-1
DRILLING COMPANY: Mobile Augers & Research Ltd.	DATE DRILLED: January 20, 2014	PROJECT NO: 17-834-167
DRILL/METHOD: M5 Track / Solid Stem Augers	LOCATION: See Drawing #17-834-167-1	ELEVATION:

SAMPLE TYPE	<input type="checkbox"/> GRAB SAMPLE	<input checked="" type="checkbox"/> SPT	<input type="checkbox"/> SHELBY TUBE
BACKFILL TYPE	<input type="checkbox"/> BENTONITE	<input checked="" type="checkbox"/> DRILL CUTTINGS	<input type="checkbox"/> SLOUGH

DEPTH (m)	SAMPLE TYPE	SPT (N)	CPEN (kPa)			REMARKS	SLOTTED PIEZOMETER	USC	SOIL SYMBOL	SOIL DESCRIPTION	DEPTH (m)
			50	100	150						
10		29	10	20	30	>>>▲Cpen > 215kPa		CI	CLAY (TILL) - CONTINUED -trace coal	10	
11									END OF TEST HOLE AT 10.4m UPON COMPLETION: (Below ground surface) -Slough at 10.2m -No water Standpipe piezometer installed WATER LEVEL BELOW GROUND SURFACE: -January 20, 2014 = Dry -February 4, 2014 = 9.5m -November 20, 2020 = Dry	11	
12										12	
13										13	
14										14	
15										15	
16										16	
17										17	
18										18	
19										19	
20										20	

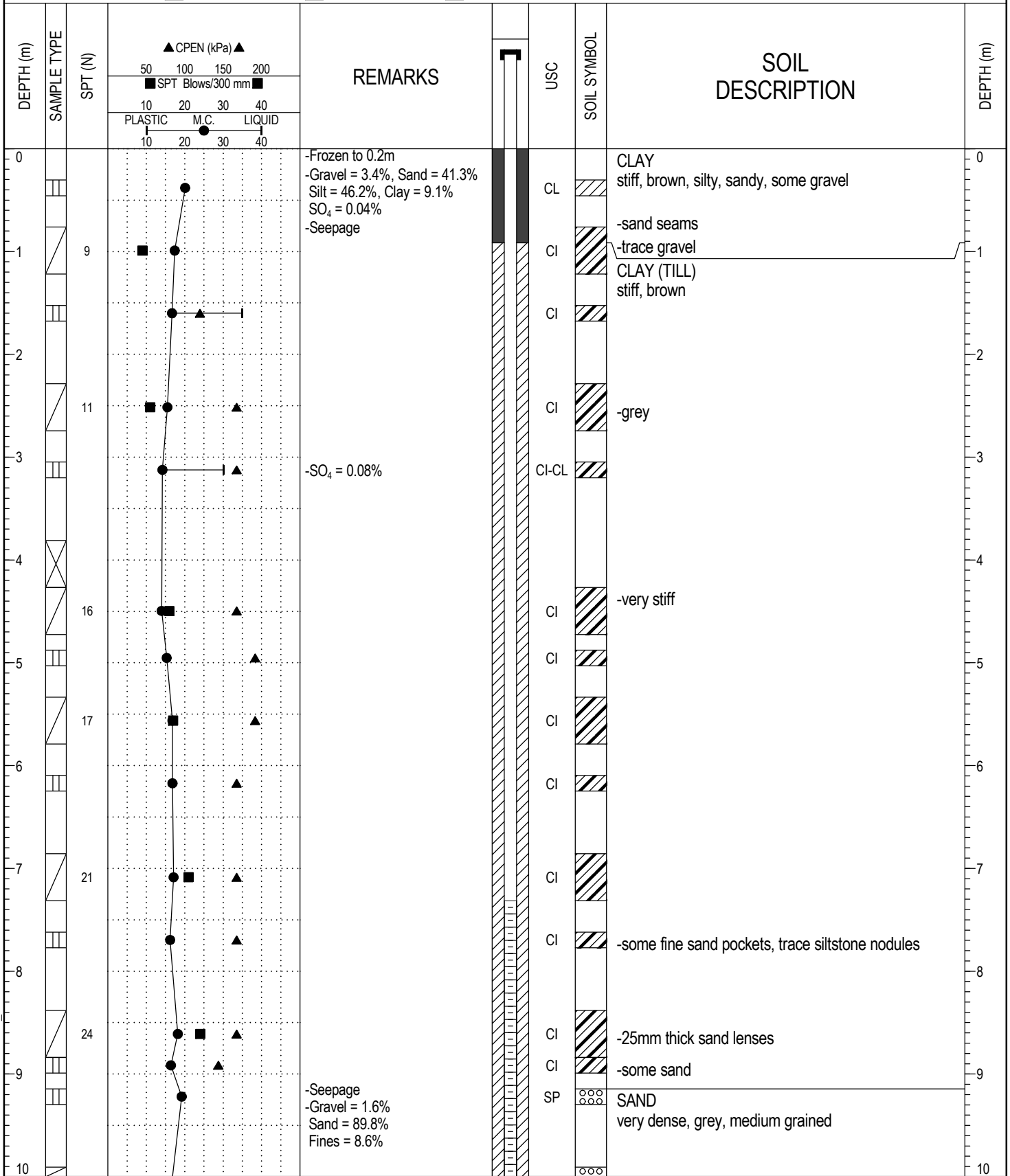
BOREHOLE LOG 17-834-167.GPJ_THRR-AB.GDT_20-12-1-LIBRARY-NEW.LOGO.GLB



FIELD LOGGED BY: YCL	COMPLETION DEPTH: 10.4 m
PREPARED BY: SEC	COMPLETION DATE: 14-1-20
REVIEWED BY: TSA	

CLIENT: CH2M HILL CANADA LTD	PROJECT: WELLINGTON BRIDGE ASSESSMENT	BOREHOLE NO: TH14-2
DRILLING COMPANY: Mobile Augers & Research Ltd.	DATE DRILLED: January 20, 2014	PROJECT NO: 17-834-167
DRILL/METHOD: M5 Track / Solid Stem Augers	LOCATION: See Drawing #17-834-167-1	ELEVATION:

SAMPLE TYPE	<input type="checkbox"/> GRAB SAMPLE	<input checked="" type="checkbox"/> SPT	<input checked="" type="checkbox"/> NO RECOVERY
BACKFILL TYPE	<input checked="" type="checkbox"/> BENTONITE	<input checked="" type="checkbox"/> DRILL CUTTINGS	<input type="checkbox"/> SLOUGH



BOREHOLE LOG 17-834-167.GPJ, THRRB, AB.GDT, 20-12-14-LIBRARY-NEW.LOGO.GLB



FIELD LOGGED BY: YCL	COMPLETION DEPTH: 11.9 m
PREPARED BY: SEC	COMPLETION DATE: 14-1-20
REVIEWED BY: TSA	

CLIENT: CH2M HILL CANADA LTD	PROJECT: WELLINGTON BRIDGE ASSESSMENT	BOREHOLE NO: TH14-2	
DRILLING COMPANY: Mobile Augers & Research Ltd.	DATE DRILLED: January 20, 2014	PROJECT NO: 17-834-167	
DRILL/METHOD: M5 Track / Solid Stem Augers	LOCATION: See Drawing #17-834-167-1	ELEVATION:	
SAMPLE TYPE	<input type="checkbox"/> GRAB SAMPLE	<input checked="" type="checkbox"/> SPT	<input checked="" type="checkbox"/> NO RECOVERY
BACKFILL TYPE	<input checked="" type="checkbox"/> BENTONITE	<input checked="" type="checkbox"/> DRILL CUTTINGS	<input type="checkbox"/> SLOUGH

DEPTH (m)	SAMPLE TYPE	SPT (N)	REMARKS			SLOTTED PIEZOMETER	USC	SOIL SYMBOL	SOIL DESCRIPTION	DEPTH (m)
			CPEN (kPa)	SPT Blows/300 mm	PLASTIC					
10		50	100				SP	SAND - CONTINUED	10	
11							SP-SM		11	
12		9	20				SM	-loose	12	
12	END OF TEST HOLE AT 11.9m UPON COMPLETION: (Below ground surface) -Slough at 10.1m -Water at 8.8m Standpipe piezometer installed WATER LEVEL BELOW GROUND SURFACE: -January 20, 2014 = Dry -February 4, 2014 = 11.1m -November 20, 2020 = 11.1m								12	
13									13	
14									14	
15									15	
16									16	
17									17	
18									18	
19									19	
20									20	

BOREHOLE LOG 17-834-167.GPJ_THRR-AB.GDT_20-12-1-LIBRARY-NEW.LOGO.GLB

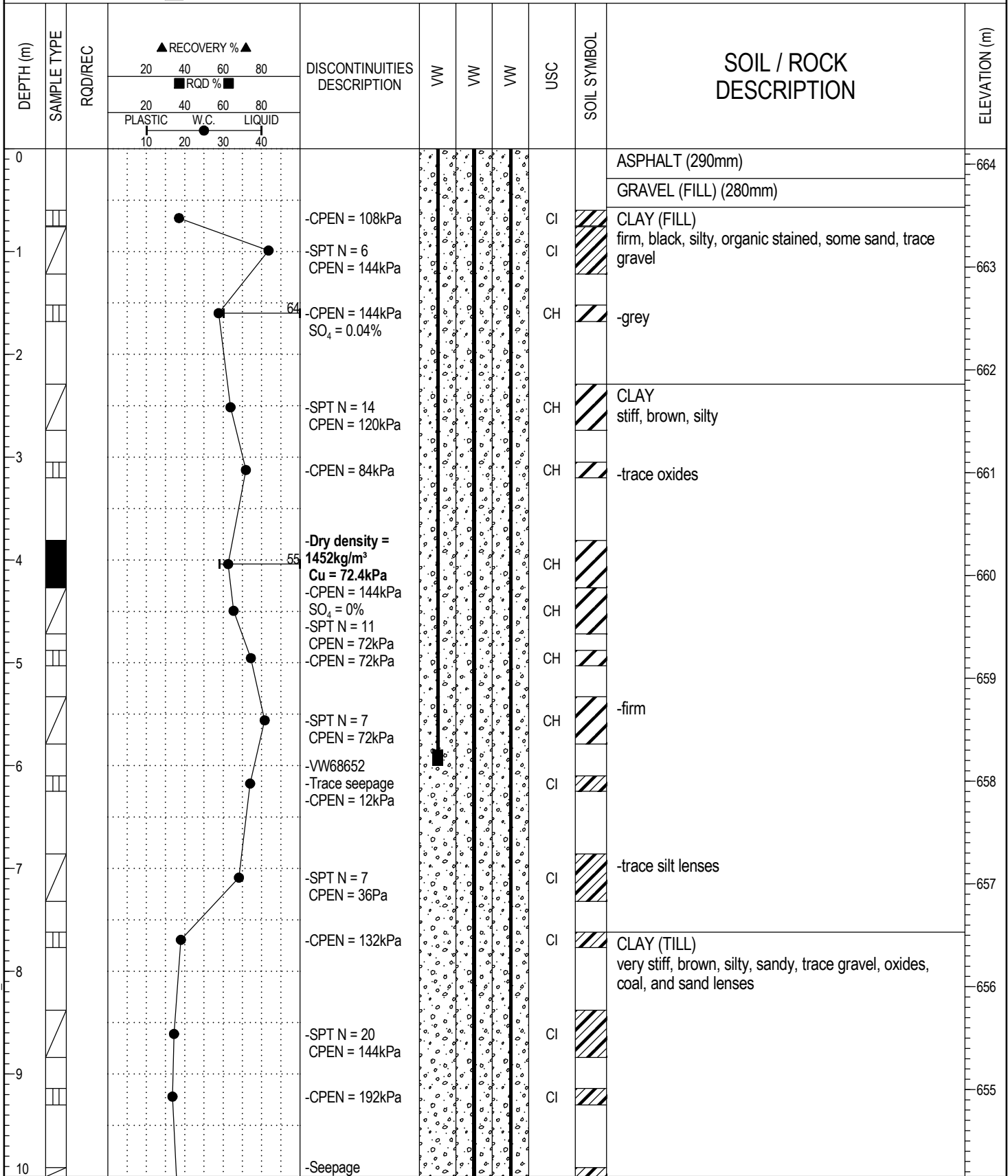


FIELD LOGGED BY: YCL	COMPLETION DEPTH: 11.9m
PREPARED BY: SEC	COMPLETION DATE: 14-1-20
REVIEWED BY: TSA	

CLIENT: Associated Engineering Alberta Ltd	PROJECT: WELLINGTON BRIDGE REPLACEMENT	BOREHOLE NO: TH20-01
DRILLING COMPANY: Mobile Augers & Research Ltd.	DATE DRILLED: October 17 to 19, 2020	PROJECT NO: 28874
DRILL/METHOD: M10 / Solid Stem Augers - Coring	LOCATION: N5934563.632, E29912.863	ELEVATION: 664.15 (m)

SAMPLE TYPE	<input type="checkbox"/> GRAB SAMPLE	<input checked="" type="checkbox"/> SPT	<input checked="" type="checkbox"/> SHELBY TUBE	<input checked="" type="checkbox"/> NO RECOVERY	<input checked="" type="checkbox"/> CORE
-------------	--------------------------------------	---	---	---	--

BACKFILL TYPE	<input checked="" type="checkbox"/> GROUT
---------------	---



BOREHOLE LOG 28874-ROCK-VW.GPJ_THRBR_AB.GDT_21-1-27-REGULAR-LIBRARY-ROCK-VW.GLB

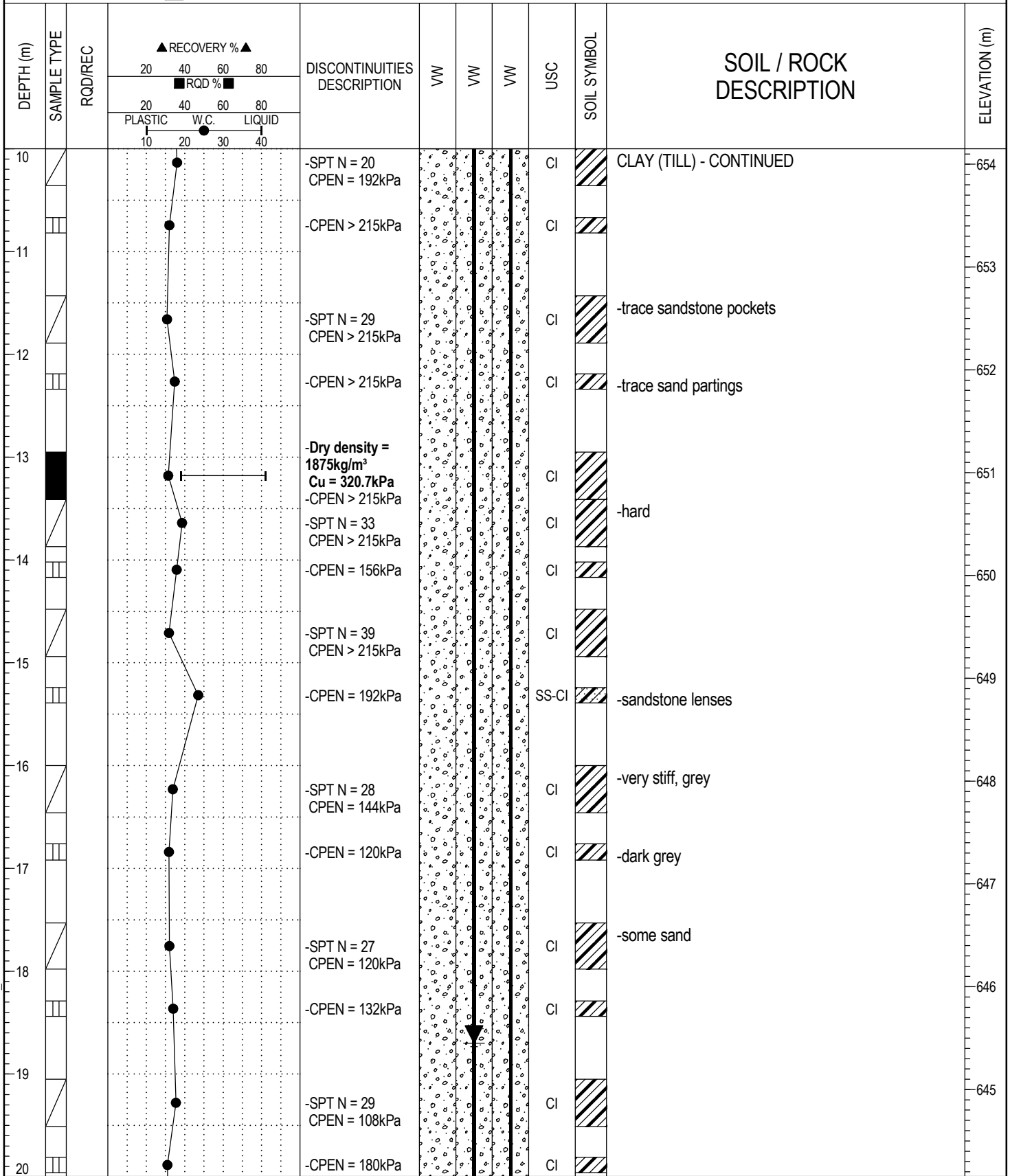


FIELD LOGGED BY: NNM	COMPLETION DEPTH: 54.0 m
PREPARED BY: SEC	COMPLETION DATE: 20-10-19
REVIEWED BY: TSA	Page 1 of 6

CLIENT: Associated Engineering Alberta Ltd	PROJECT: WELLINGTON BRIDGE REPLACEMENT	BOREHOLE NO: TH20-01
DRILLING COMPANY: Mobile Augers & Research Ltd.	DATE DRILLED: October 17 to 19, 2020	PROJECT NO: 28874
DRILL/METHOD: M10 / Solid Stem Augers - Coring	LOCATION: N5934563.632, E29912.863	ELEVATION: 664.15 (m)

SAMPLE TYPE	<input type="checkbox"/> GRAB SAMPLE	<input checked="" type="checkbox"/> SPT	<input type="checkbox"/> SHELBY TUBE	<input checked="" type="checkbox"/> NO RECOVERY	<input type="checkbox"/> CORE
-------------	--------------------------------------	---	--------------------------------------	---	-------------------------------

BACKFILL TYPE	<input checked="" type="checkbox"/> GROUT
---------------	---

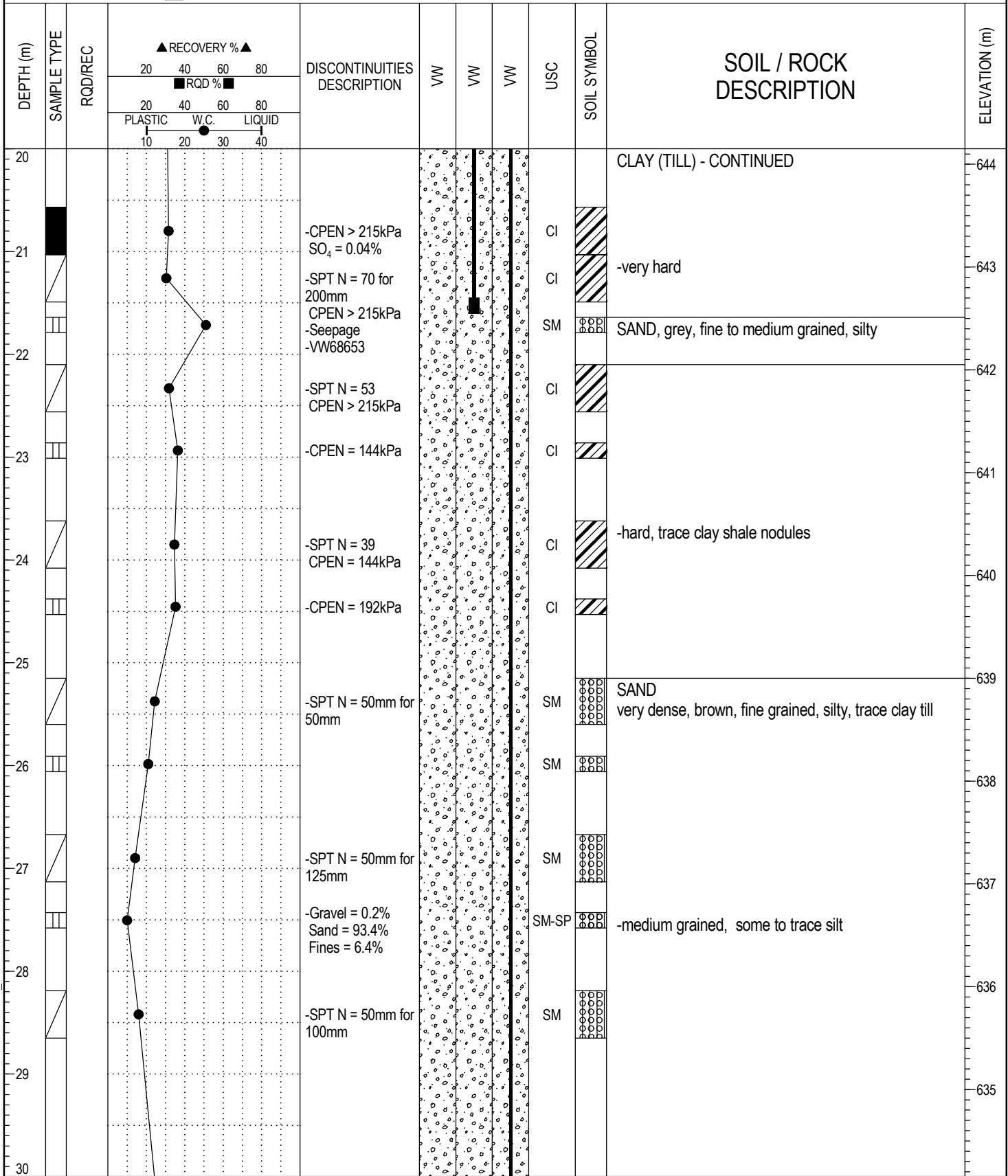


FIELD LOGGED BY: NNM	COMPLETION DEPTH: 54.0 m
PREPARED BY: SEC	COMPLETION DATE: 20-10-19
REVIEWED BY: TSA	Page 2 of 6

CLIENT: Associated Engineering Alberta Ltd	PROJECT: WELLINGTON BRIDGE REPLACEMENT	BOREHOLE NO: TH20-01
DRILLING COMPANY: Mobile Augers & Research Ltd.	DATE DRILLED: October 17 to 19, 2020	PROJECT NO: 28874
DRILL/METHOD: M10 / Solid Stem Augers - Coring	LOCATION: N5934563.632, E29912.863	ELEVATION: 664.15 (m)

SAMPLE TYPE	<input type="checkbox"/> GRAB SAMPLE	<input checked="" type="checkbox"/> SPT	<input type="checkbox"/> SHELBY TUBE	<input checked="" type="checkbox"/> NO RECOVERY	<input type="checkbox"/> CORE
-------------	--------------------------------------	---	--------------------------------------	---	-------------------------------

BACKFILL TYPE	<input checked="" type="checkbox"/> GROUT
---------------	---



BOREHOLE LOG 28874-ROCK-VW.GPJ_THRBR_AB.GDT_21-1-27-REGULAR-LIBRARY-ROCK-VW.GLB

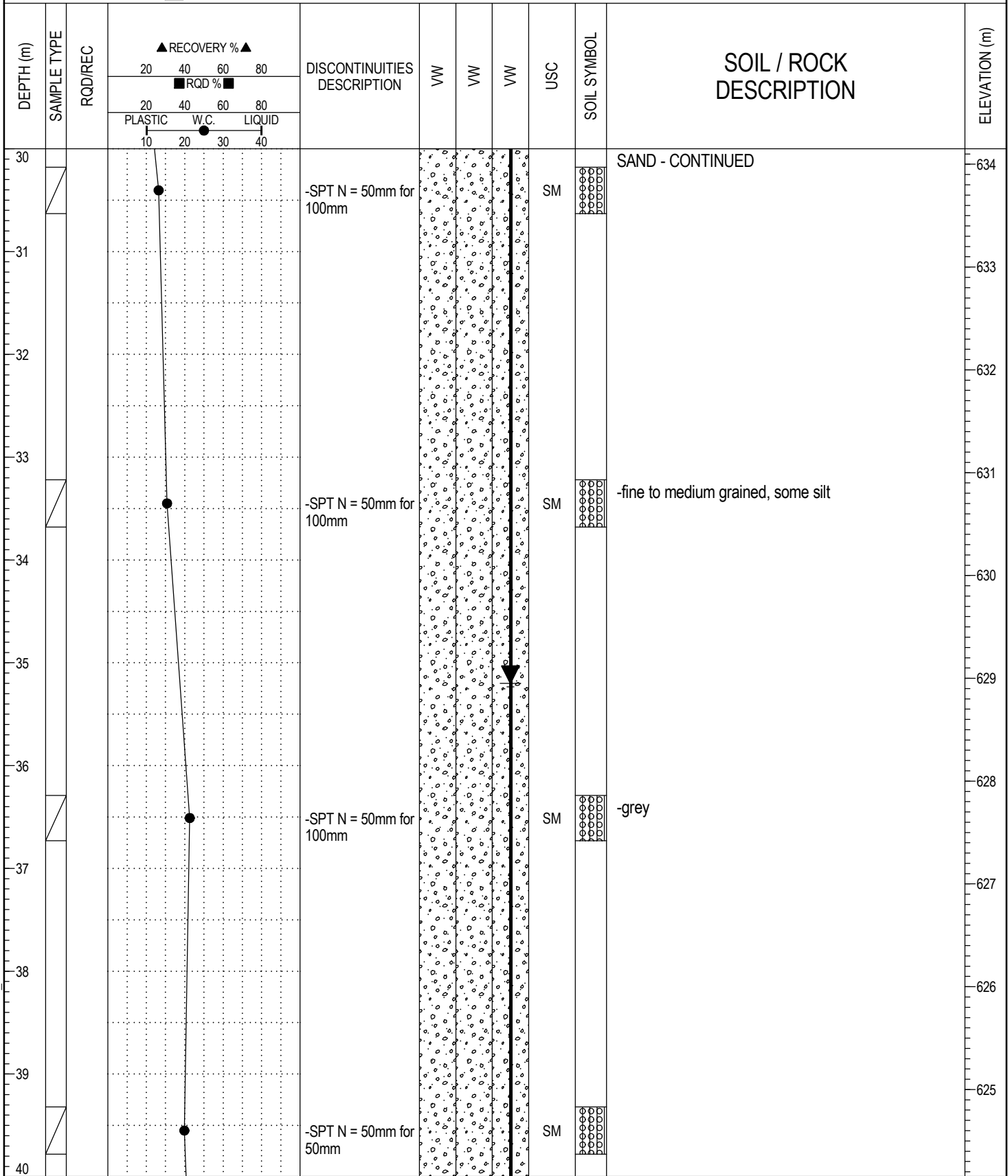


FIELD LOGGED BY: NNM	COMPLETION DEPTH: 54.0 m
PREPARED BY: SEC	COMPLETION DATE: 20-10-19
REVIEWED BY: TSA	Page 3 of 6

CLIENT: Associated Engineering Alberta Ltd	PROJECT: WELLINGTON BRIDGE REPLACEMENT	BOREHOLE NO: TH20-01
DRILLING COMPANY: Mobile Augers & Research Ltd.	DATE DRILLED: October 17 to 19, 2020	PROJECT NO: 28874
DRILL/METHOD: M10 / Solid Stem Augers - Coring	LOCATION: N5934563.632, E29912.863	ELEVATION: 664.15 (m)

SAMPLE TYPE	<input type="checkbox"/> GRAB SAMPLE	<input checked="" type="checkbox"/> SPT	<input type="checkbox"/> SHELBY TUBE	<input checked="" type="checkbox"/> NO RECOVERY	<input type="checkbox"/> CORE
-------------	--------------------------------------	---	--------------------------------------	---	-------------------------------

BACKFILL TYPE	<input checked="" type="checkbox"/> GROUT
---------------	---



BOREHOLE LOG 28874-ROCK-VW.GPJ_THRBR_AB.GDT_21-1-27-REGULAR-LIBRARY-ROCK-VW.GLB

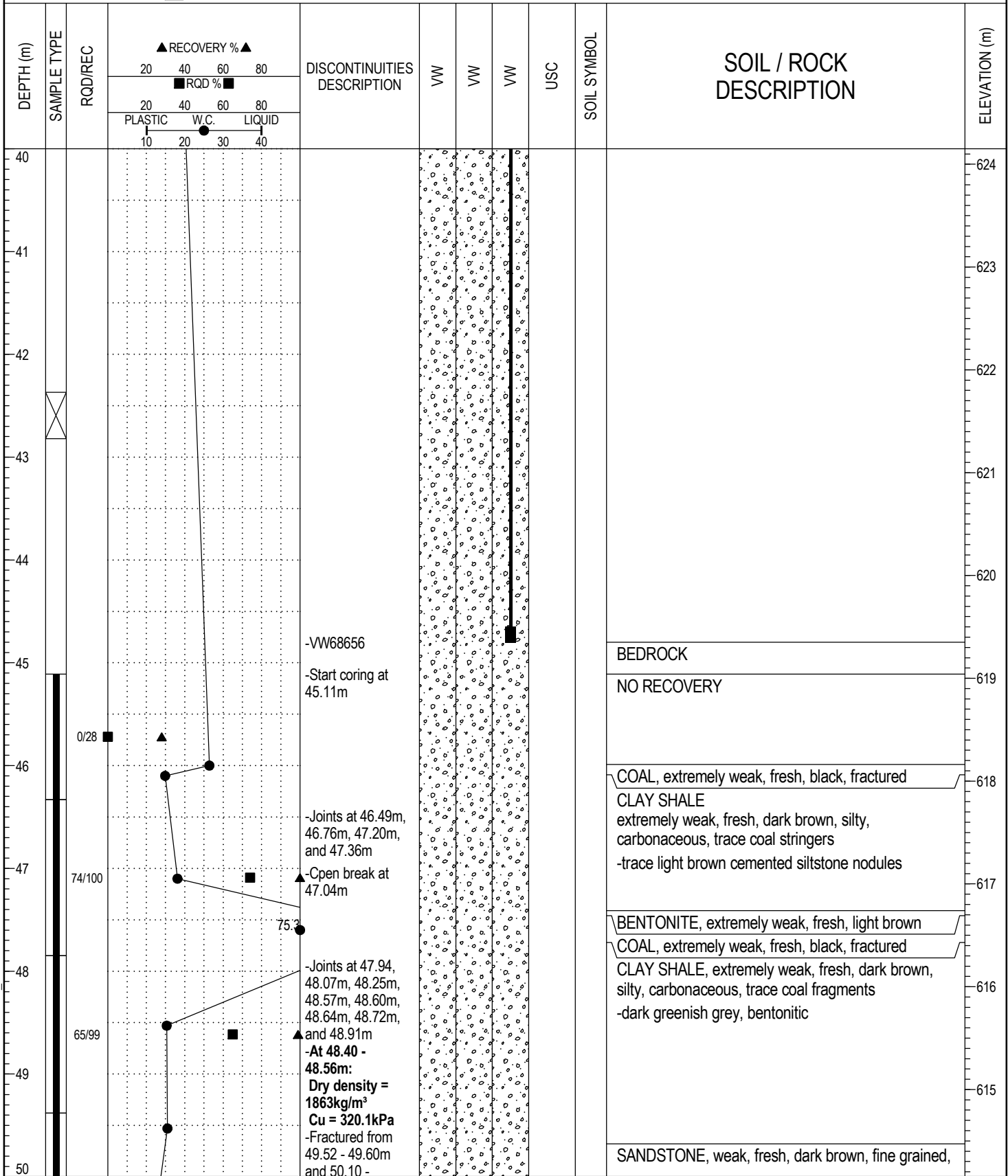


FIELD LOGGED BY: NNM	COMPLETION DEPTH: 54.0 m
PREPARED BY: SEC	COMPLETION DATE: 20-10-19
REVIEWED BY: TSA	Page 4 of 6

CLIENT: Associated Engineering Alberta Ltd	PROJECT: WELLINGTON BRIDGE REPLACEMENT	BOREHOLE NO: TH20-01
DRILLING COMPANY: Mobile Augers & Research Ltd.	DATE DRILLED: October 17 to 19, 2020	PROJECT NO: 28874
DRILL/METHOD: M10 / Solid Stem Augers - Coring	LOCATION: N5934563.632, E29912.863	ELEVATION: 664.15 (m)

SAMPLE TYPE	<input type="checkbox"/> GRAB SAMPLE	<input checked="" type="checkbox"/> SPT	<input checked="" type="checkbox"/> SHELBY TUBE	<input checked="" type="checkbox"/> NO RECOVERY	<input type="checkbox"/> CORE
-------------	--------------------------------------	---	---	---	-------------------------------

BACKFILL TYPE	<input checked="" type="checkbox"/> GROUT
---------------	---



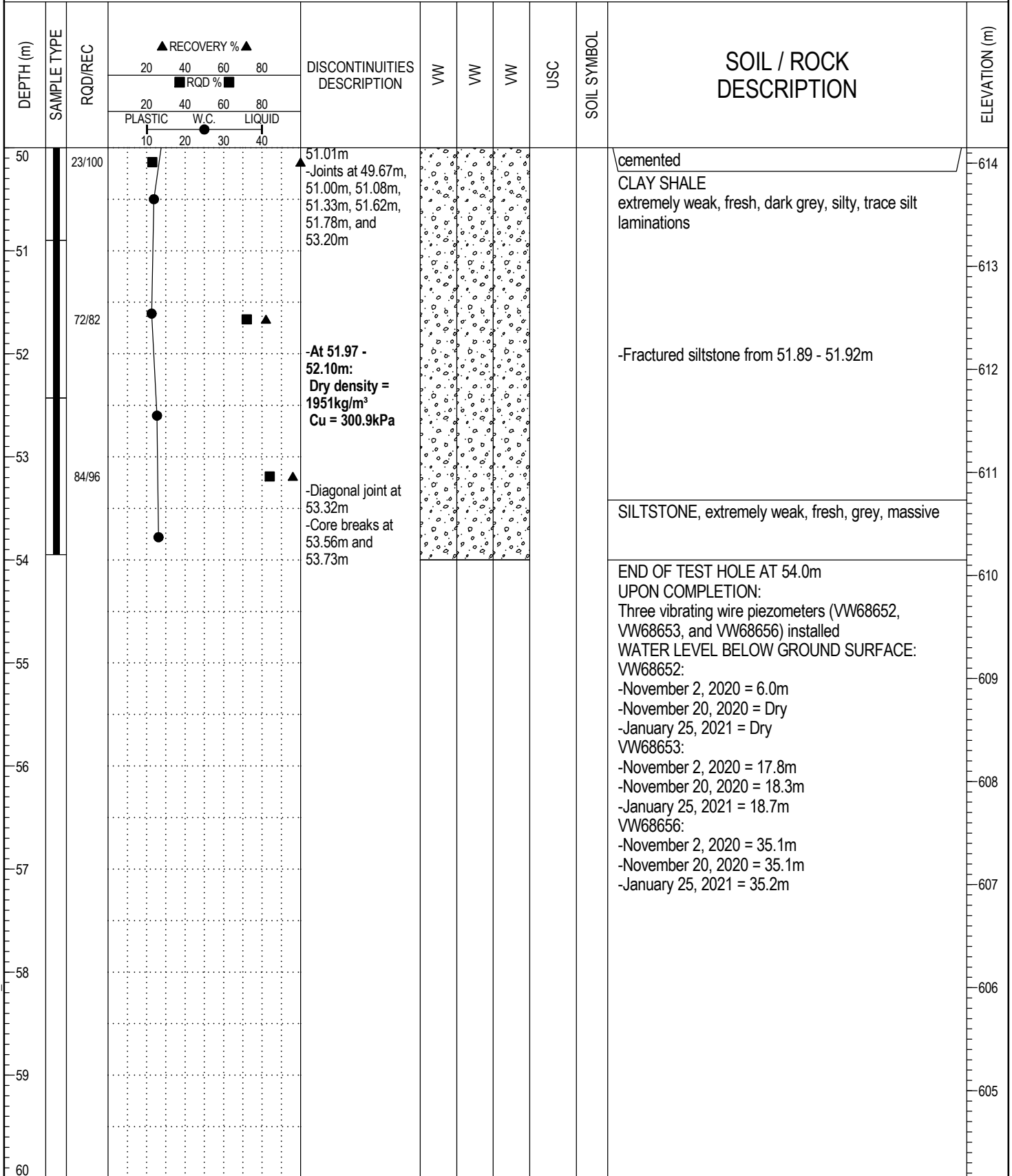
BOREHOLE LOG 28874-ROCK-VW.GPJ_THRBR_AB.GDT_21-1-27-REGULAR-LIBRARY-ROCK-VW.GLB



CLIENT: Associated Engineering Alberta Ltd	PROJECT: WELLINGTON BRIDGE REPLACEMENT	BOREHOLE NO: TH20-01
DRILLING COMPANY: Mobile Augers & Research Ltd.	DATE DRILLED: October 17 to 19, 2020	PROJECT NO: 28874
DRILL/METHOD: M10 / Solid Stem Augers - Coring	LOCATION: N5934563.632, E29912.863	ELEVATION: 664.15 (m)

SAMPLE TYPE	<input type="checkbox"/> GRAB SAMPLE	<input checked="" type="checkbox"/> SPT	<input type="checkbox"/> SHELBY TUBE	<input checked="" type="checkbox"/> NO RECOVERY	<input type="checkbox"/> CORE
-------------	--------------------------------------	---	--------------------------------------	---	-------------------------------

BACKFILL TYPE	<input checked="" type="checkbox"/> GROUT
---------------	---



BOREHOLE LOG 28874-ROCK-VW.GPJ_THRBR_AB.GDT_21-1-27-REGULAR-LIBRARY-ROCK-VW.GLB

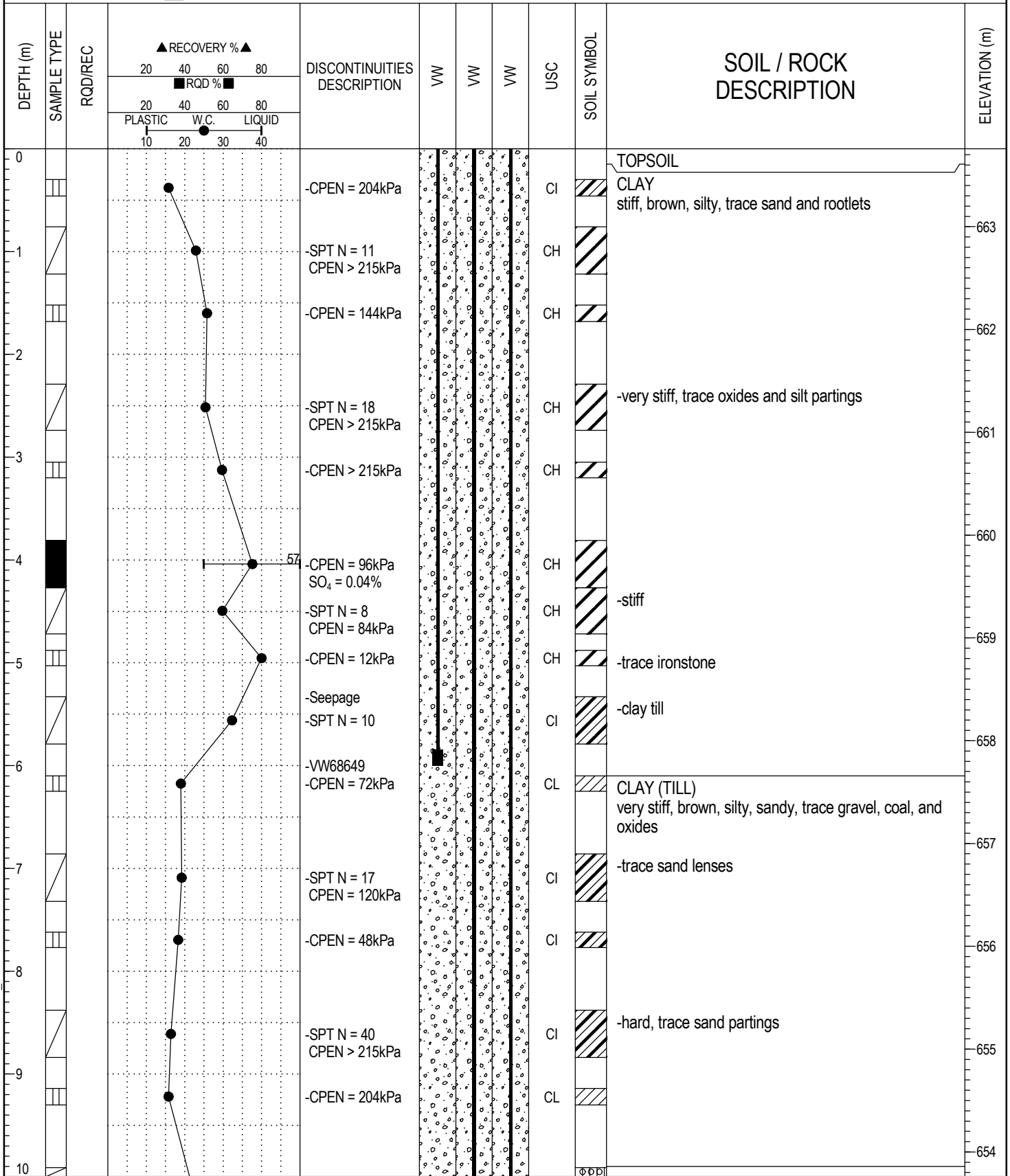


FIELD LOGGED BY: NNM	COMPLETION DEPTH: 54.0 m
PREPARED BY: SEC	COMPLETION DATE: 20-10-19
REVIEWED BY: TSA	Page 6 of 6

CLIENT: Associated Engineering Alberta Ltd	PROJECT: WELLINGTON BRIDGE REPLACEMENT	BOREHOLE NO: TH20-02
DRILLING COMPANY: Mobile Augers & Research Ltd.	DATE DRILLED: October 13 to 16, 2020	PROJECT NO: 28874
DRILL/METHOD: M10 / Solid Stem Augers - Coring	LOCATION: N5934541.104, E29992.289	ELEVATION: 663.76 (m)

SAMPLE TYPE	<input type="checkbox"/> GRAB SAMPLE	<input checked="" type="checkbox"/> SPT	<input checked="" type="checkbox"/> SHELBY TUBE	<input checked="" type="checkbox"/> NO RECOVERY	<input checked="" type="checkbox"/> CORE
-------------	--------------------------------------	---	---	---	--

BACKFILL TYPE	<input checked="" type="checkbox"/> GROUT
---------------	---



BOREHOLE LOG 28874-ROCK-VW.GPJ_THRBR_AB.GDT_21-1-27-REGULAR-LIBRARY-ROCK-VW.GLB

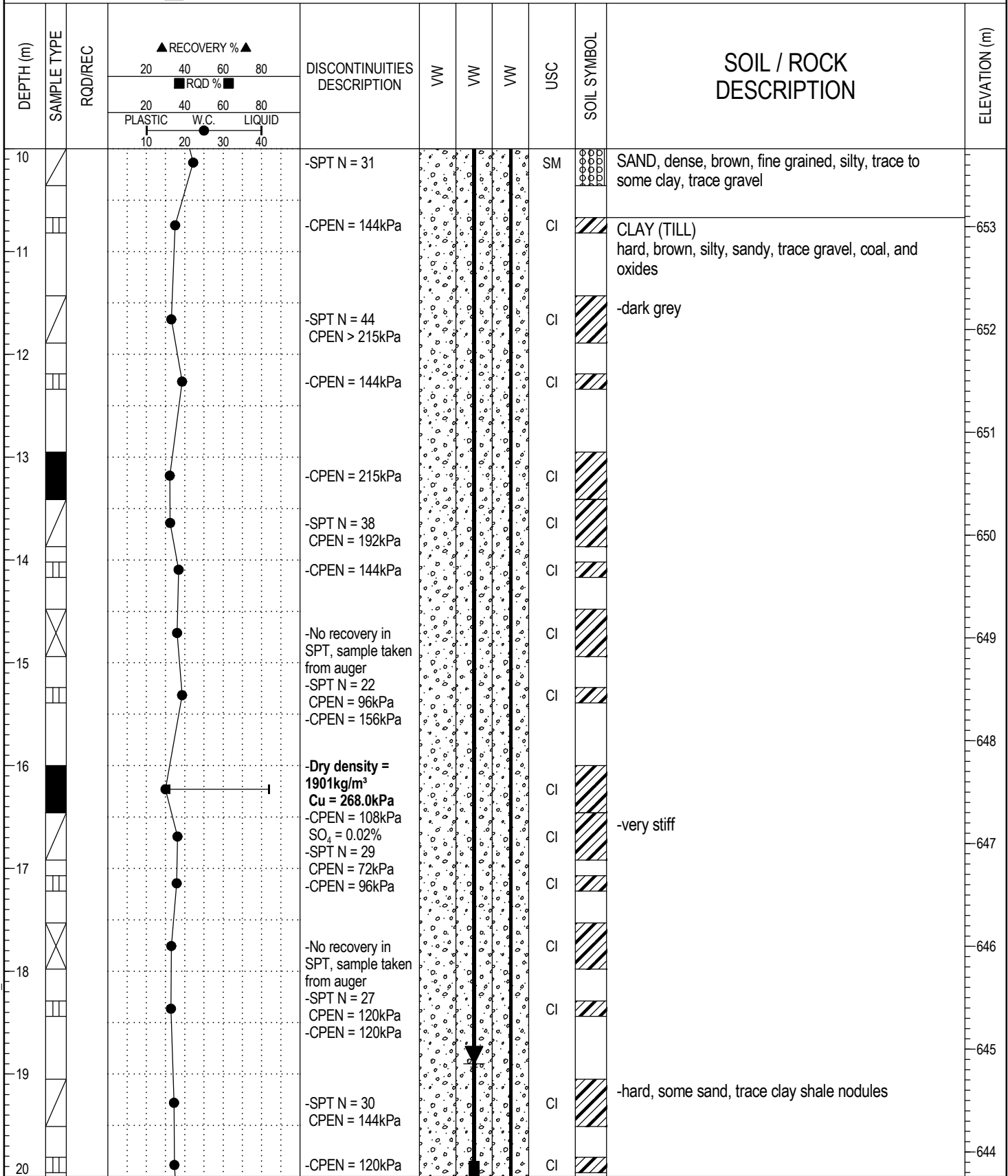


FIELD LOGGED BY: NNM	COMPLETION DEPTH: 60.2 m
PREPARED BY: SEC	COMPLETION DATE: 20-10-16
REVIEWED BY: TSA	Page 1 of 7

CLIENT: Associated Engineering Alberta Ltd	PROJECT: WELLINGTON BRIDGE REPLACEMENT	BOREHOLE NO: TH20-02
DRILLING COMPANY: Mobile Augers & Research Ltd.	DATE DRILLED: October 13 to 16, 2020	PROJECT NO: 28874
DRILL/METHOD: M10 / Solid Stem Augers - Coring	LOCATION: N5934541.104, E29992.289	ELEVATION: 663.76 (m)

SAMPLE TYPE	<input type="checkbox"/> GRAB SAMPLE	<input checked="" type="checkbox"/> SPT	<input type="checkbox"/> SHELBY TUBE	<input checked="" type="checkbox"/> NO RECOVERY	<input type="checkbox"/> CORE
-------------	--------------------------------------	---	--------------------------------------	---	-------------------------------

BACKFILL TYPE	<input checked="" type="checkbox"/> GROUT
---------------	---



BOREHOLE LOG 28874-ROCK-VW.GPJ_THRBR_AB.GDT_21-1-27-REGULAR-LIBRARY-ROCK-VW.GLB

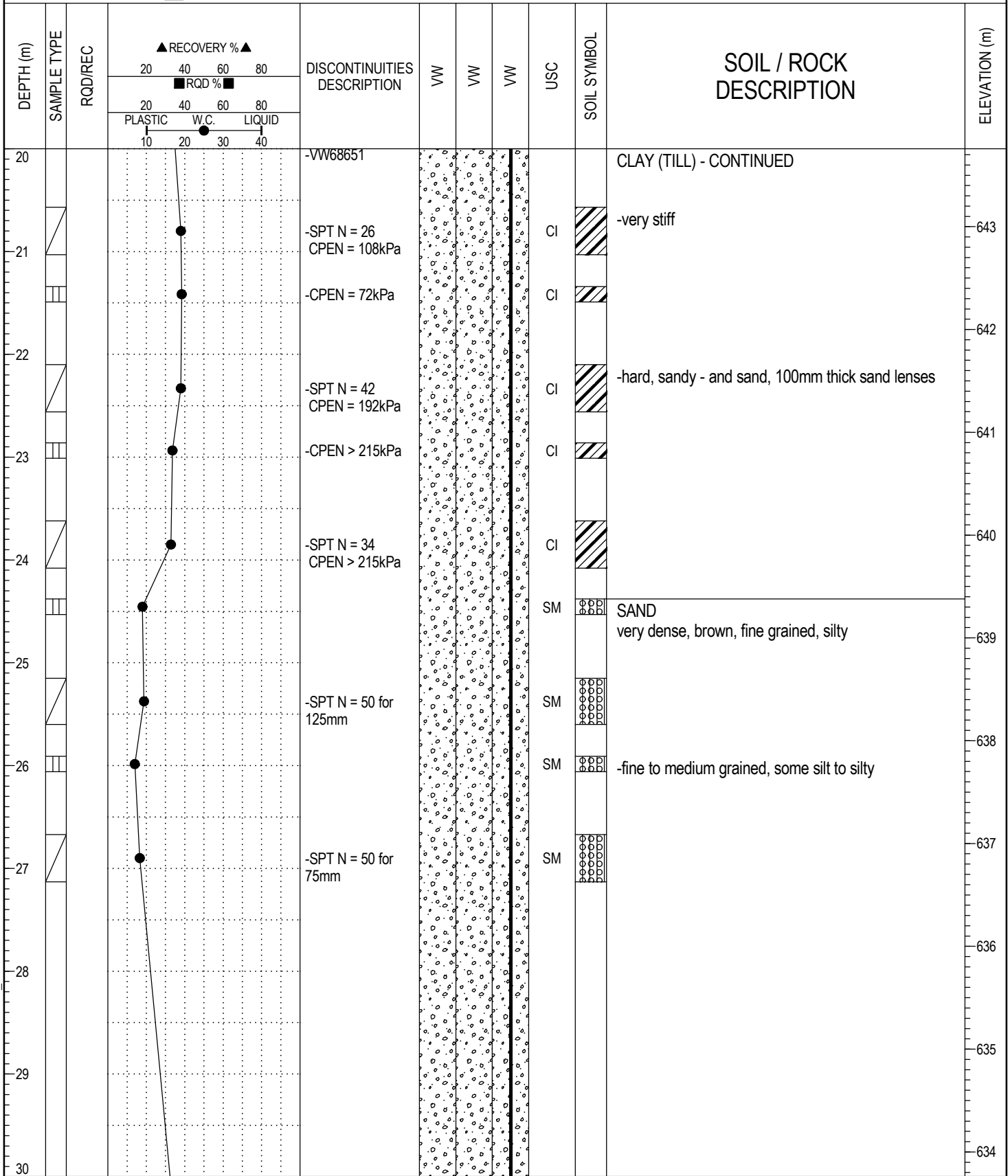


FIELD LOGGED BY: NNM	COMPLETION DEPTH: 60.2 m
PREPARED BY: SEC	COMPLETION DATE: 20-10-16
REVIEWED BY: TSA	Page 2 of 7

CLIENT: Associated Engineering Alberta Ltd	PROJECT: WELLINGTON BRIDGE REPLACEMENT	BOREHOLE NO: TH20-02
DRILLING COMPANY: Mobile Augers & Research Ltd.	DATE DRILLED: October 13 to 16, 2020	PROJECT NO: 28874
DRILL/METHOD: M10 / Solid Stem Augers - Coring	LOCATION: N5934541.104, E29992.289	ELEVATION: 663.76 (m)

SAMPLE TYPE	<input type="checkbox"/> GRAB SAMPLE	<input checked="" type="checkbox"/> SPT	<input type="checkbox"/> SHELBY TUBE	<input checked="" type="checkbox"/> NO RECOVERY	<input type="checkbox"/> CORE
-------------	--------------------------------------	---	--------------------------------------	---	-------------------------------

BACKFILL TYPE	<input checked="" type="checkbox"/> GROUT
---------------	---



BOREHOLE LOG 28874-ROCK-VW-GPJ_THRBR-AB.GDT_21-1-27-REGULAR-LIBRARY-ROCK-VW.GLB

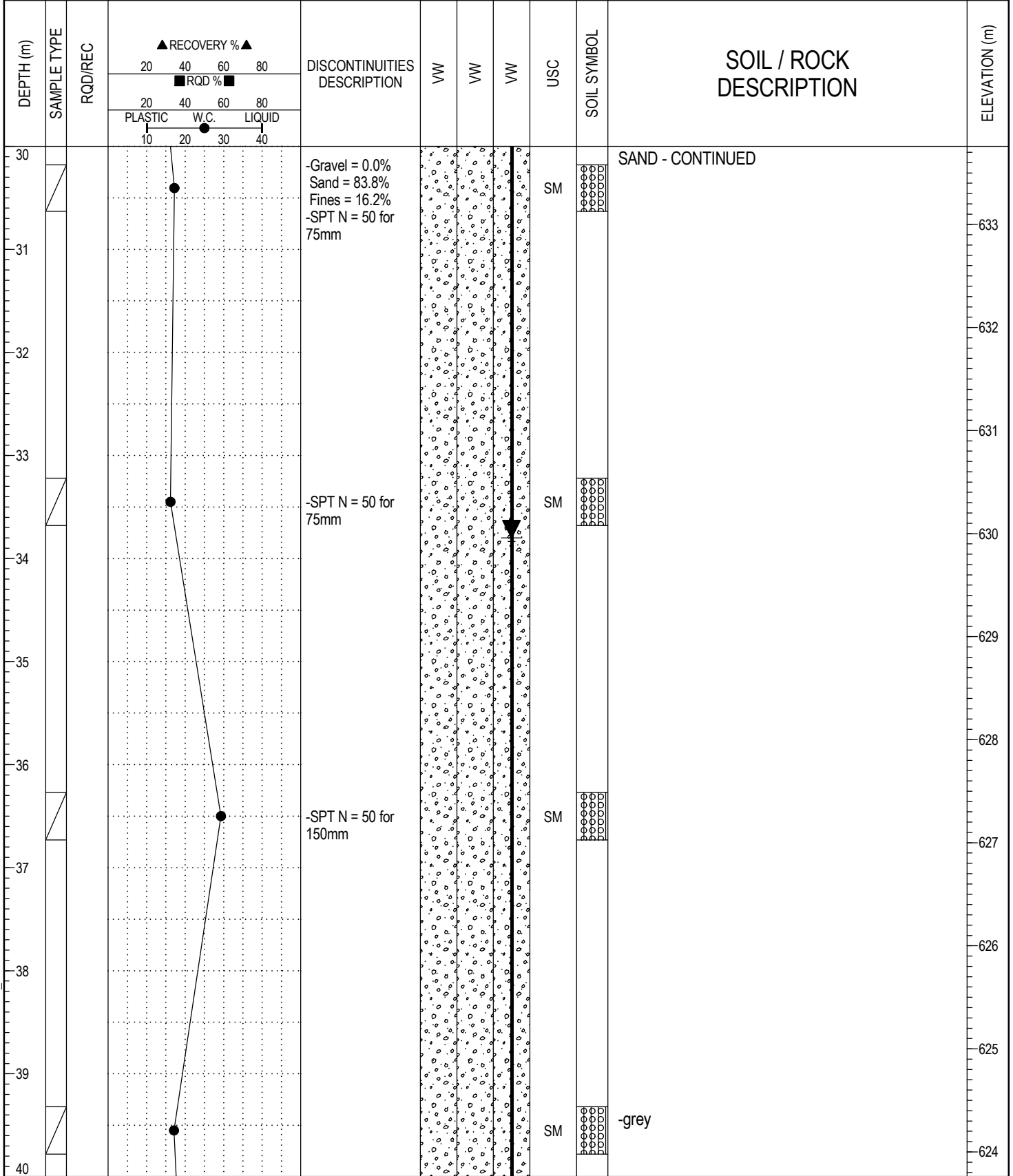


FIELD LOGGED BY: NNM	COMPLETION DEPTH: 60.2 m
PREPARED BY: SEC	COMPLETION DATE: 20-10-16
REVIEWED BY: TSA	Page 3 of 7

CLIENT: Associated Engineering Alberta Ltd	PROJECT: WELLINGTON BRIDGE REPLACEMENT	BOREHOLE NO: TH20-02
DRILLING COMPANY: Mobile Augers & Research Ltd.	DATE DRILLED: October 13 to 16, 2020	PROJECT NO: 28874
DRILL/METHOD: M10 / Solid Stem Augers - Coring	LOCATION: N5934541.104, E29992.289	ELEVATION: 663.76 (m)

SAMPLE TYPE	<input type="checkbox"/> GRAB SAMPLE	<input checked="" type="checkbox"/> SPT	<input type="checkbox"/> SHELBY TUBE	<input checked="" type="checkbox"/> NO RECOVERY	<input type="checkbox"/> CORE
-------------	--------------------------------------	---	--------------------------------------	---	-------------------------------

BACKFILL TYPE	<input checked="" type="checkbox"/> GROUT
---------------	---



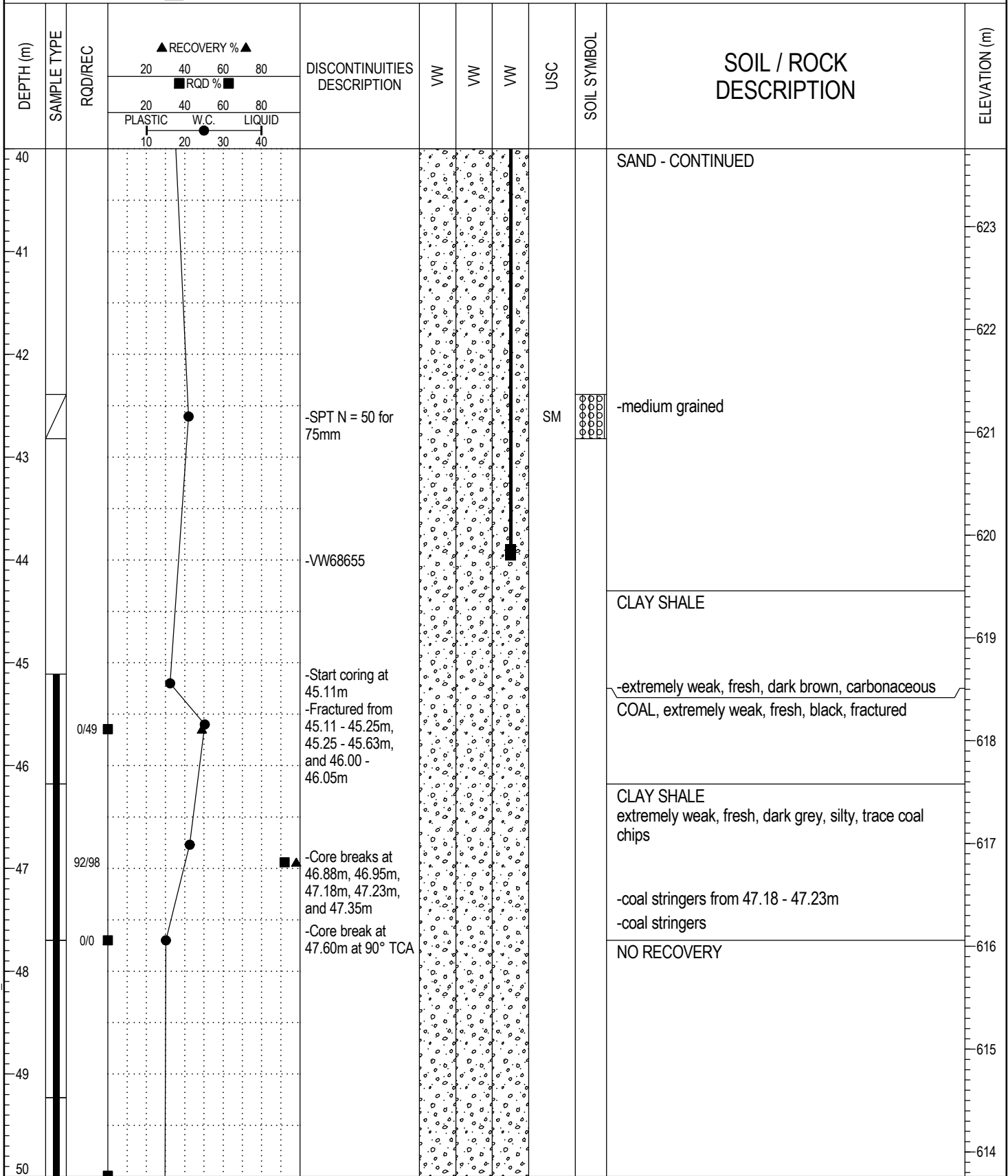
BOREHOLE LOG 28874-ROCK-VW.GPJ_THRBR_AB.GDT_21-1-27-REGULAR-LIBRARY-ROCK-VW.GLB



FIELD LOGGED BY: NNM	COMPLETION DEPTH: 60.2 m
PREPARED BY: SEC	COMPLETION DATE: 20-10-16
REVIEWED BY: TSA	Page 4 of 7

CLIENT: Associated Engineering Alberta Ltd	PROJECT: WELLINGTON BRIDGE REPLACEMENT	BOREHOLE NO: TH20-02
DRILLING COMPANY: Mobile Augers & Research Ltd.	DATE DRILLED: October 13 to 16, 2020	PROJECT NO: 28874
DRILL/METHOD: M10 / Solid Stem Augers - Coring	LOCATION: N5934541.104, E29992.289	ELEVATION: 663.76 (m)

SAMPLE TYPE	<input type="checkbox"/> GRAB SAMPLE	<input checked="" type="checkbox"/> SPT	<input checked="" type="checkbox"/> SHELBY TUBE	<input checked="" type="checkbox"/> NO RECOVERY	<input type="checkbox"/> CORE
BACKFILL TYPE	<input checked="" type="checkbox"/> GROUT				



BOREHOLE LOG 28874-ROCK-VW-GPJ_THRBR_AB.GDT 21-1-27- REGULAR LIBRARY-ROCK - VW.GLB

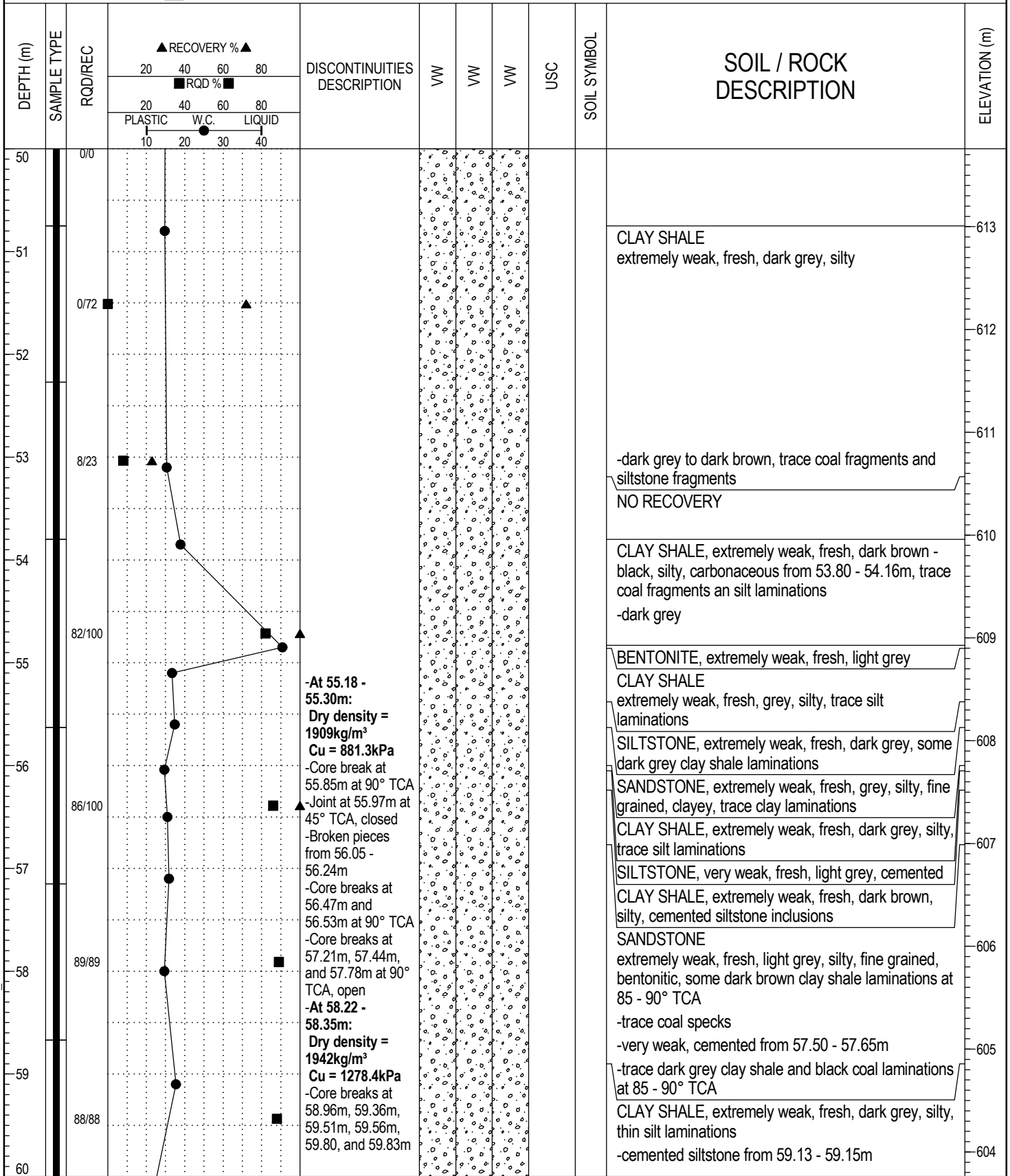


FIELD LOGGED BY: NNM	COMPLETION DEPTH: 60.2 m
PREPARED BY: SEC	COMPLETION DATE: 20-10-16
REVIEWED BY: TSA	Page 5 of 7

CLIENT: Associated Engineering Alberta Ltd	PROJECT: WELLINGTON BRIDGE REPLACEMENT	BOREHOLE NO: TH20-02
DRILLING COMPANY: Mobile Augers & Research Ltd.	DATE DRILLED: October 13 to 16, 2020	PROJECT NO: 28874
DRILL/METHOD: M10 / Solid Stem Augers - Coring	LOCATION: N5934541.104, E29992.289	ELEVATION: 663.76 (m)

SAMPLE TYPE	<input type="checkbox"/> GRAB SAMPLE	<input checked="" type="checkbox"/> SPT	<input checked="" type="checkbox"/> SHELBY TUBE	<input checked="" type="checkbox"/> NO RECOVERY	<input checked="" type="checkbox"/> CORE
-------------	--------------------------------------	---	---	---	--

BACKFILL TYPE	<input checked="" type="checkbox"/> GROUT
---------------	---



BOREHOLE LOG 28874-ROCK-VW-GPJ_THRRR_AB.GDT_21-1-27-REGULAR-LIBRARY-ROCK-VW.GLB



CLIENT: Associated Engineering Alberta Ltd	PROJECT: WELLINGTON BRIDGE REPLACEMENT	BOREHOLE NO: TH20-02
DRILLING COMPANY: Mobile Augers & Research Ltd.	DATE DRILLED: October 13 to 16, 2020	PROJECT NO: 28874
DRILL/METHOD: M10 / Solid Stem Augers - Coring	LOCATION: N5934541.104, E29992.289	ELEVATION: 663.76 (m)
SAMPLE TYPE	<input type="checkbox"/> GRAB SAMPLE <input checked="" type="checkbox"/> SPT <input checked="" type="checkbox"/> SHELBY TUBE <input checked="" type="checkbox"/> NO RECOVERY <input type="checkbox"/> CORE	
BACKFILL TYPE	<input checked="" type="checkbox"/> GROUT	

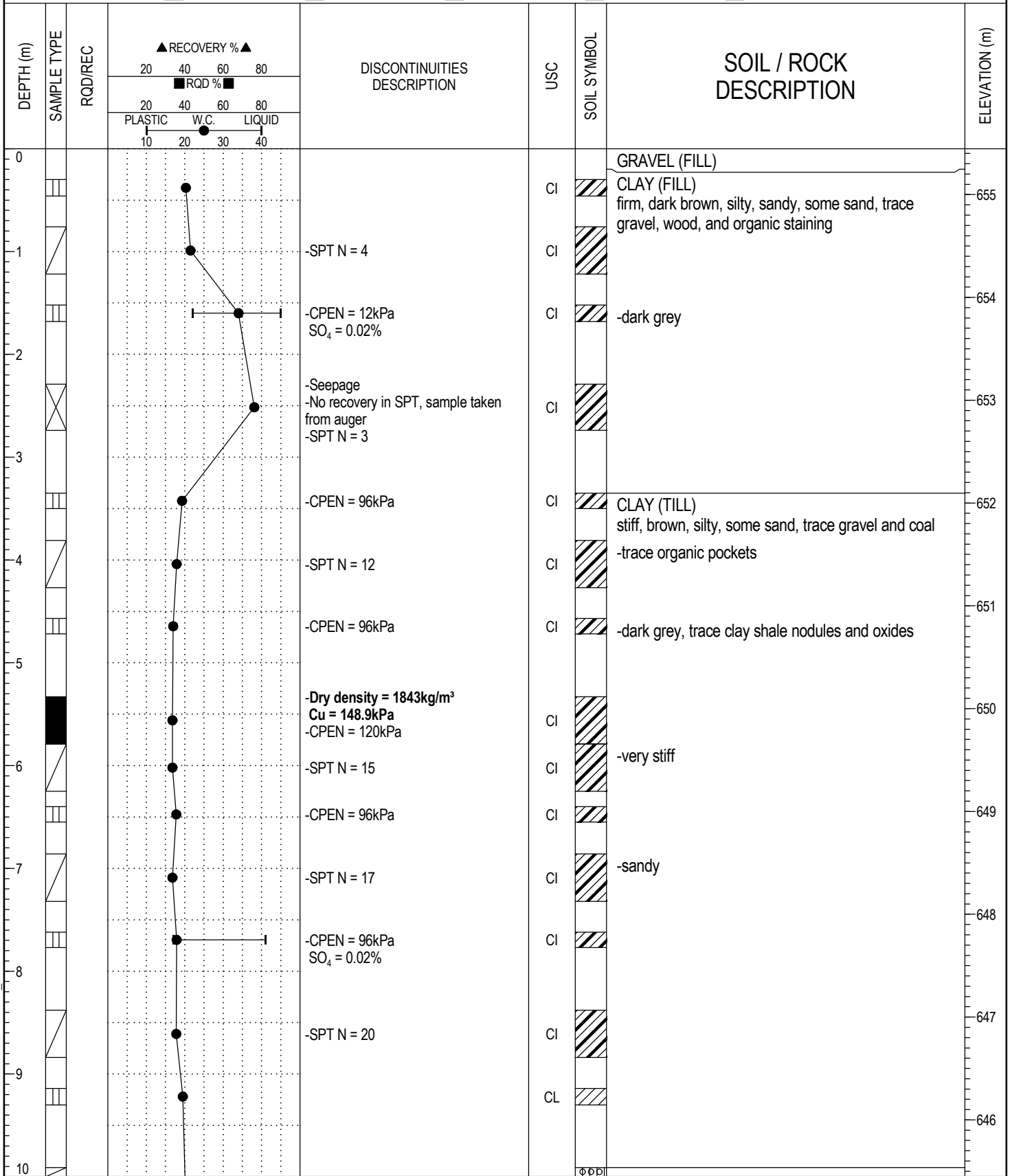
DEPTH (m)	SAMPLE TYPE	RQD/REC	RECOVERY %				DISCONTINUITIES DESCRIPTION	VW	VW	VW	USC	SOIL SYMBOL	SOIL / ROCK DESCRIPTION	ELEVATION (m)
			RQD %											
			20	40	60	80								
60			20	40	60	80						-trace light brown cemented siltstone inclusions	603	
61												END OF TEST HOLE AT 60.2m UPON COMPLETION: Three vibrating wire piezometers (VW68649, VW68651, and VW68655) installed WATER LEVEL BELOW GROUND SURFACE: VW68649: -November 2, 2020 = 5.97m -November 20, 2020 = Dry -January 25, 2021 = Dry	602	
62												VW68651: -November 2, 2020 = 18.8m -November 20, 2020 = 19.1m -January 25, 2021 = 18.9m	601	
63												VW68655: -November 2, 2020 = 33.7m -November 20, 2020 = 33.7m -January 25, 2021 = 33.8m	600	
64													599	
65													598	
66													597	
67													596	
68													595	
69													594	
70														

BOREHOLE LOG 28874-ROCK-VW.GPJ_THRBR_AB.GDT_21-1-27-REGULAR-LIBRARY-ROCK-VW.GLB



FIELD LOGGED BY: NNM	COMPLETION DEPTH: 60.2 m
PREPARED BY: SEC	COMPLETION DATE: 20-10-16
REVIEWED BY: TSA	Page 7 of 7

CLIENT: Associated Engineering Alberta Ltd	PROJECT: WELLINGTON BRIDGE REPLACEMENT	BOREHOLE NO: TH20-03
DRILLING COMPANY: ALL SERVICE DRILLING INC	DATE DRILLED: September 16 to 19, 2020	PROJECT NO: 28874
DRILL/METHOD: D50T / Solid & Hollow Stem Augers - Coring	LOCATION: N5934567.211, E29972.362	ELEVATION: 655.45 (m)
SAMPLE TYPE <input type="checkbox"/> GRAB SAMPLE <input checked="" type="checkbox"/> SPT <input checked="" type="checkbox"/> NO RECOVERY <input checked="" type="checkbox"/> SHELBY TUBE <input checked="" type="checkbox"/> CORE		

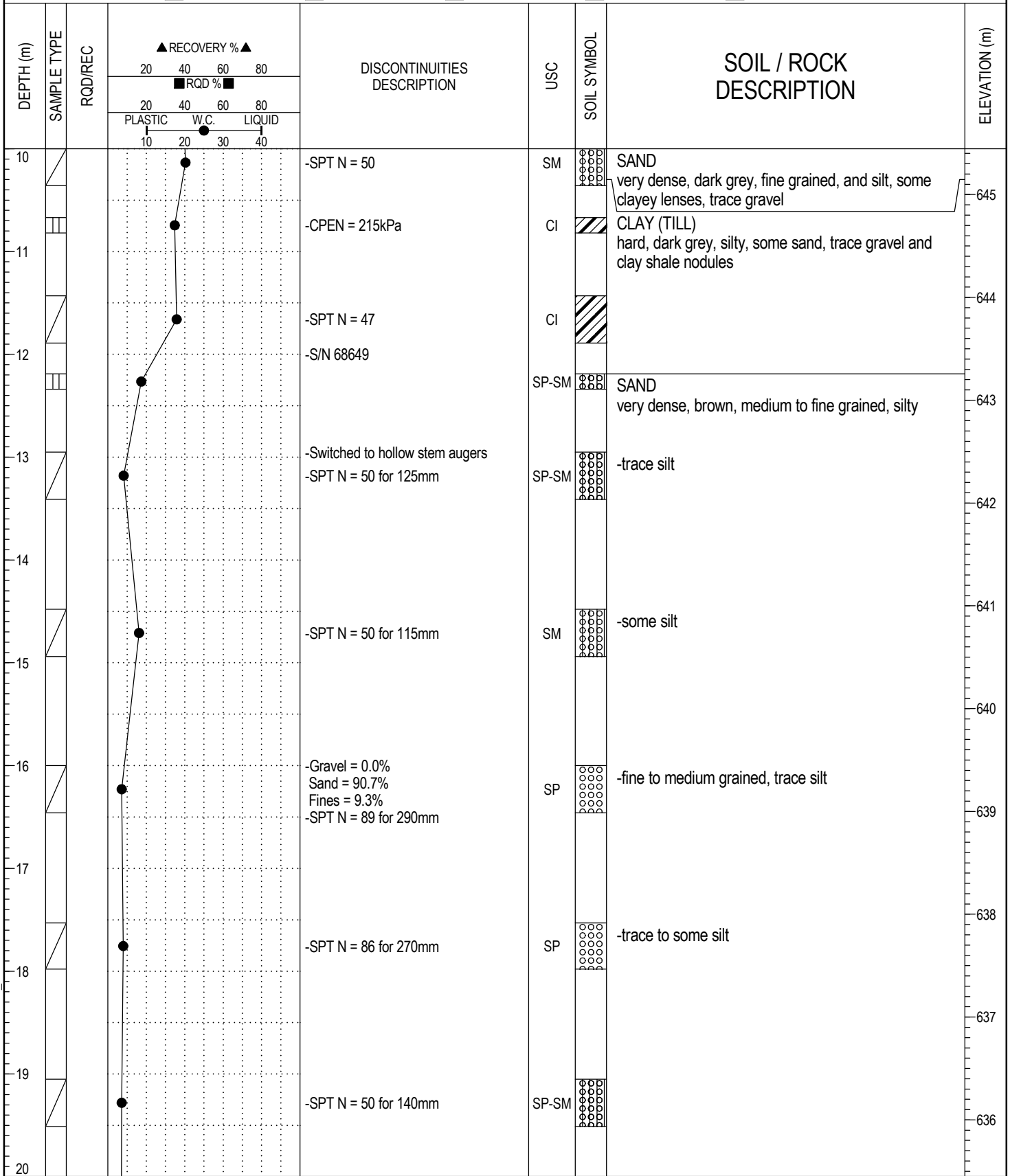


BOREHOLE LOG 28874-ROCK-VW-GPJ_THRBR_AB.GDT_21-1-27-REGULAR-LIBRARY-ROCK-VW.GLB



FIELD LOGGED BY: NNM	COMPLETION DEPTH: 44.7 m
PREPARED BY: SEC	COMPLETION DATE: 20-9-19
REVIEWED BY: TSA	Page 1 of 5

CLIENT: Associated Engineering Alberta Ltd	PROJECT: WELLINGTON BRIDGE REPLACEMENT	BOREHOLE NO: TH20-03
DRILLING COMPANY: ALL SERVICE DRILLING INC	DATE DRILLED: September 16 to 19, 2020	PROJECT NO: 28874
DRILL/METHOD: D50T / Solid & Hollow Stem Augers - Coring	LOCATION: N5934567.211, E29972.362	ELEVATION: 655.45 (m)
SAMPLE TYPE <input type="checkbox"/> GRAB SAMPLE <input checked="" type="checkbox"/> SPT <input checked="" type="checkbox"/> NO RECOVERY <input checked="" type="checkbox"/> SHELBY TUBE <input type="checkbox"/> CORE		

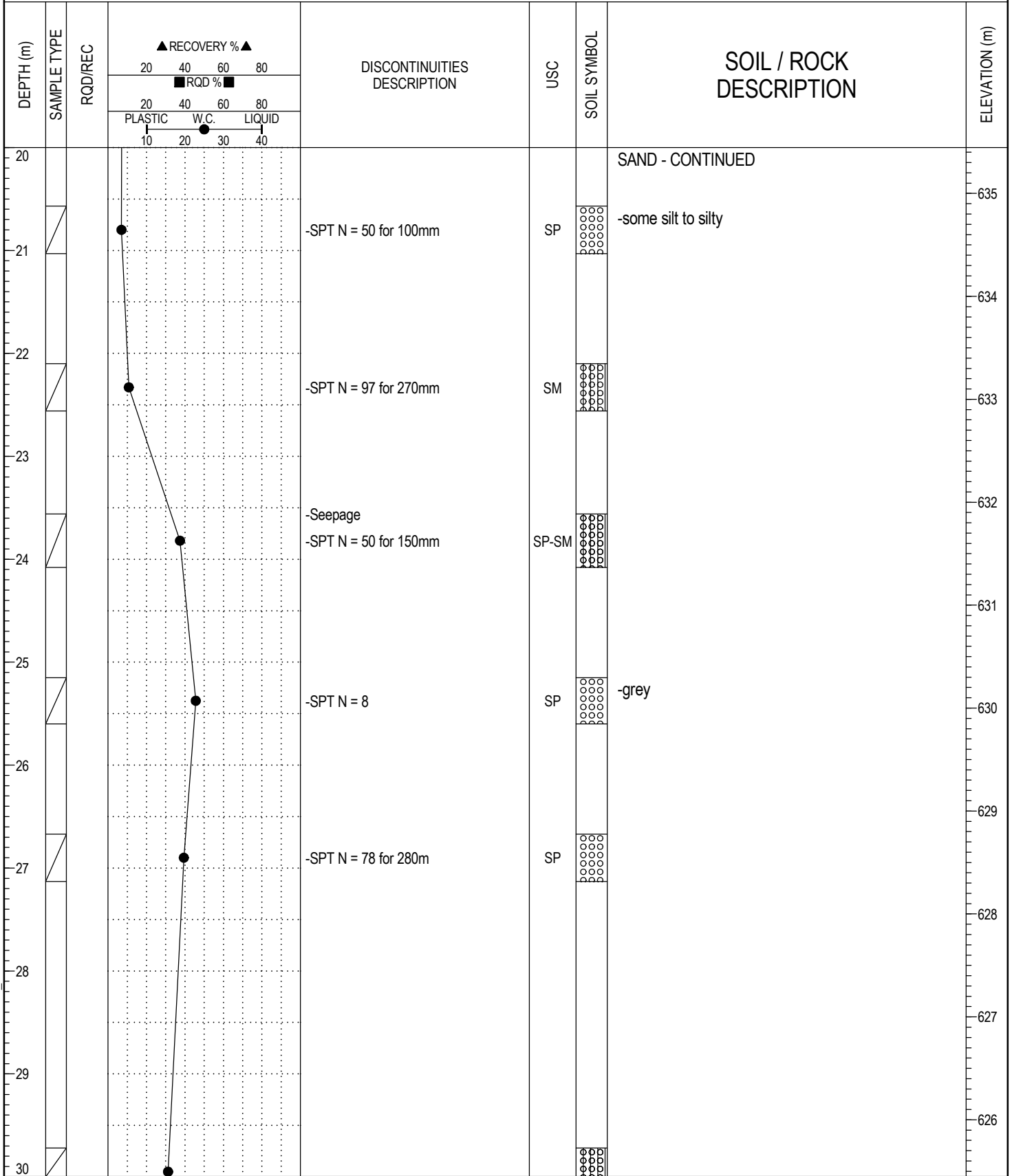


BOREHOLE LOG 28874-ROCK-VW-GPJ_THRBR_AB.GDT_21-1-27-REGULAR-LIBRARY-ROCK-VW.GLB



FIELD LOGGED BY: NNM	COMPLETION DEPTH: 44.7 m
PREPARED BY: SEC	COMPLETION DATE: 20-9-19
REVIEWED BY: TSA	Page 2 of 5

CLIENT: Associated Engineering Alberta Ltd	PROJECT: WELLINGTON BRIDGE REPLACEMENT	BOREHOLE NO: TH20-03
DRILLING COMPANY: ALL SERVICE DRILLING INC	DATE DRILLED: September 16 to 19, 2020	PROJECT NO: 28874
DRILL/METHOD: D50T / Solid & Hollow Stem Augers - Coring	LOCATION: N5934567.211, E29972.362	ELEVATION: 655.45 (m)
SAMPLE TYPE <input type="checkbox"/> GRAB SAMPLE <input checked="" type="checkbox"/> SPT <input checked="" type="checkbox"/> NO RECOVERY <input checked="" type="checkbox"/> SHELBY TUBE <input type="checkbox"/> CORE		

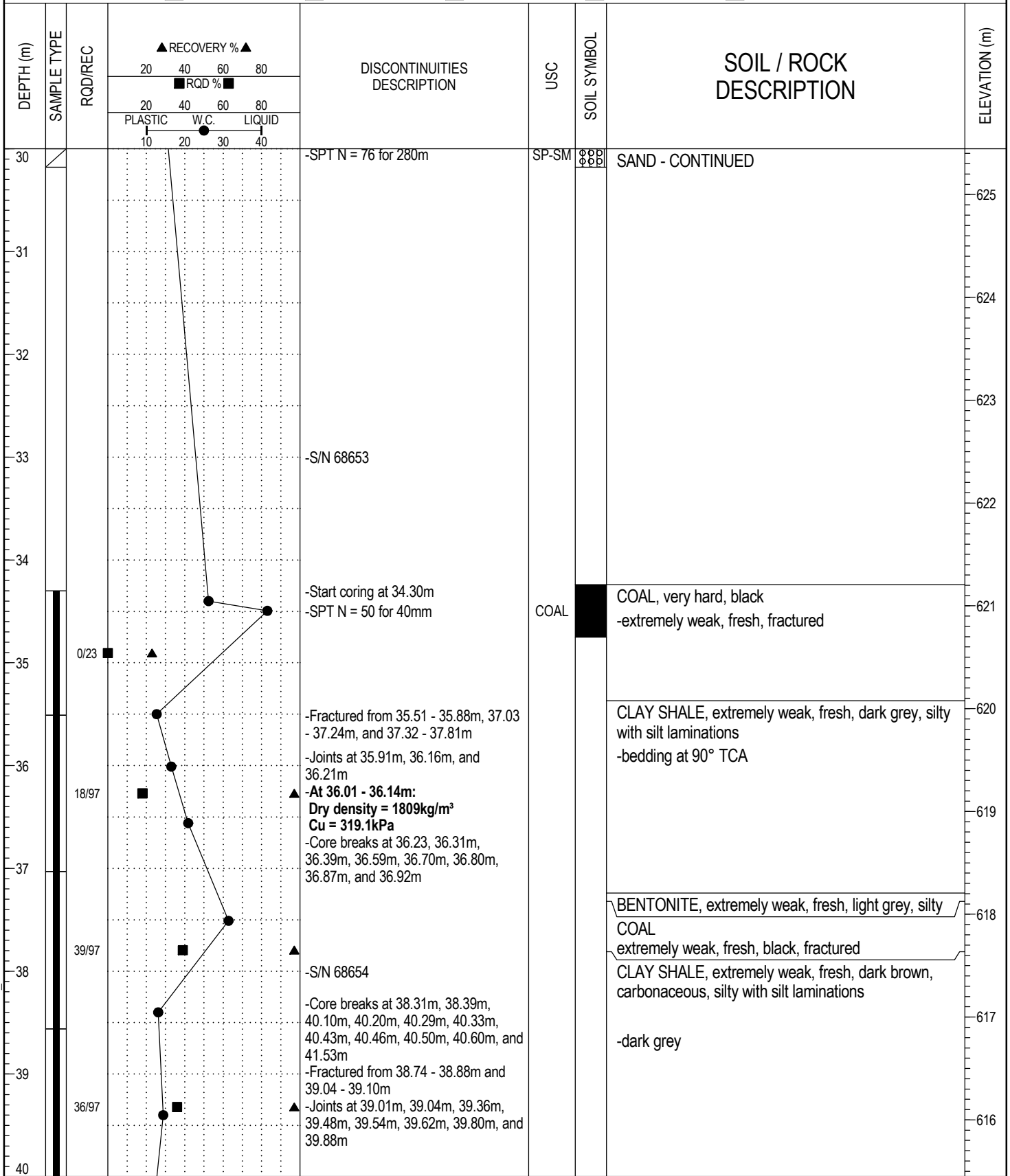


BOREHOLE LOG: 28874-ROCK-VW-GPJ_THRBR_AB.GDT_21-1-27-REGULAR-LIBRARY-ROCK-VW.GLB



FIELD LOGGED BY: NNM	COMPLETION DEPTH: 44.7 m
PREPARED BY: SEC	COMPLETION DATE: 20-9-19
REVIEWED BY: TSA	Page 3 of 5

CLIENT: Associated Engineering Alberta Ltd	PROJECT: WELLINGTON BRIDGE REPLACEMENT	BOREHOLE NO: TH20-03
DRILLING COMPANY: ALL SERVICE DRILLING INC	DATE DRILLED: September 16 to 19, 2020	PROJECT NO: 28874
DRILL/METHOD: D50T / Solid & Hollow Stem Augers - Coring	LOCATION: N5934567.211, E29972.362	ELEVATION: 655.45 (m)
SAMPLE TYPE <input type="checkbox"/> GRAB SAMPLE <input checked="" type="checkbox"/> SPT <input checked="" type="checkbox"/> NO RECOVERY <input type="checkbox"/> SHELBY TUBE <input type="checkbox"/> CORE		

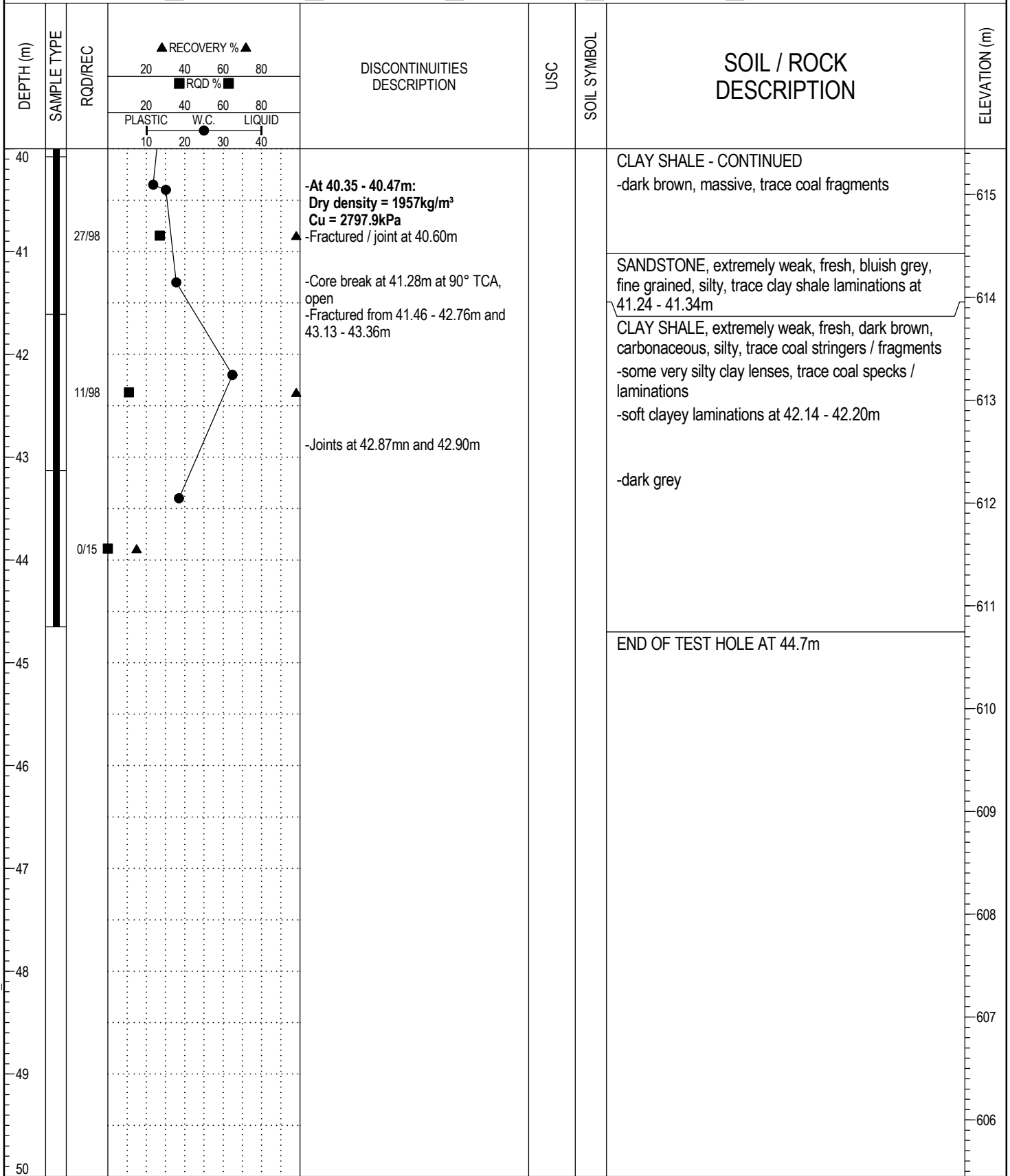


BOREHOLE LOG 28874-ROCK-VW-GPJ_THRBR_AB.GDT_21-1-27-REGULAR-LIBRARY-ROCK-VW.GLB



FIELD LOGGED BY: NNM	COMPLETION DEPTH: 44.7 m
PREPARED BY: SEC	COMPLETION DATE: 20-9-19
REVIEWED BY: TSA	Page 4 of 5

CLIENT: Associated Engineering Alberta Ltd	PROJECT: WELLINGTON BRIDGE REPLACEMENT	BOREHOLE NO: TH20-03
DRILLING COMPANY: ALL SERVICE DRILLING INC	DATE DRILLED: September 16 to 19, 2020	PROJECT NO: 28874
DRILL/METHOD: D50T / Solid & Hollow Stem Augers - Coring	LOCATION: N5934567.211, E29972.362	ELEVATION: 655.45 (m)
SAMPLE TYPE <input type="checkbox"/> GRAB SAMPLE <input checked="" type="checkbox"/> SPT <input checked="" type="checkbox"/> NO RECOVERY <input checked="" type="checkbox"/> SHELBY TUBE <input checked="" type="checkbox"/> CORE		



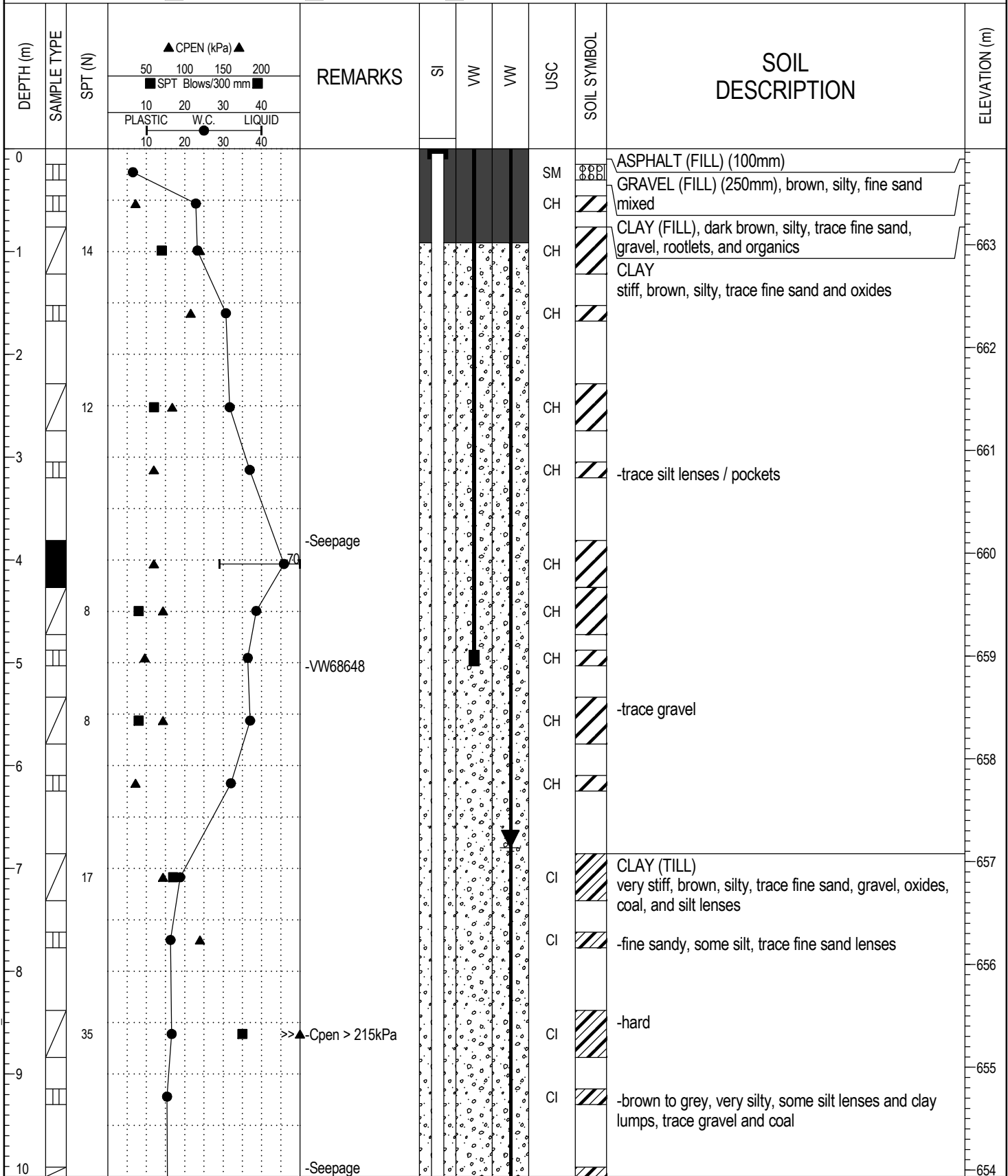
BOREHOLE LOG 28874-ROCK-VW.GPJ_THRBR_AB.GDT_21-1-27-REGULAR-LIBRARY-ROCK-VW.GLB



FIELD LOGGED BY: NNM	COMPLETION DEPTH: 44.7 m
PREPARED BY: SEC	COMPLETION DATE: 20-9-19
REVIEWED BY: TSA	Page 5 of 5

CLIENT: Associated Engineering Alberta Ltd	PROJECT: WELLINGTON BRIDGE REPLACEMENT	BOREHOLE NO: TH20-4
DRILLING COMPANY: ALL SERVICE DRILLING INC	DATE DRILLED: October 19 & 20, 2020	PROJECT NO: 28874
DRILL/METHOD: Track / Solid Stem Augers	LOCATION: N5934583.839, E29926.275	ELEVATION: 663.93 (m)

SAMPLE TYPE	<input type="checkbox"/> GRAB SAMPLE	<input checked="" type="checkbox"/> SPT	<input type="checkbox"/> SHELBY TUBE
BACKFILL TYPE	<input checked="" type="checkbox"/> BENTONITE	<input type="checkbox"/> GROUT	<input type="checkbox"/> SLOUGH



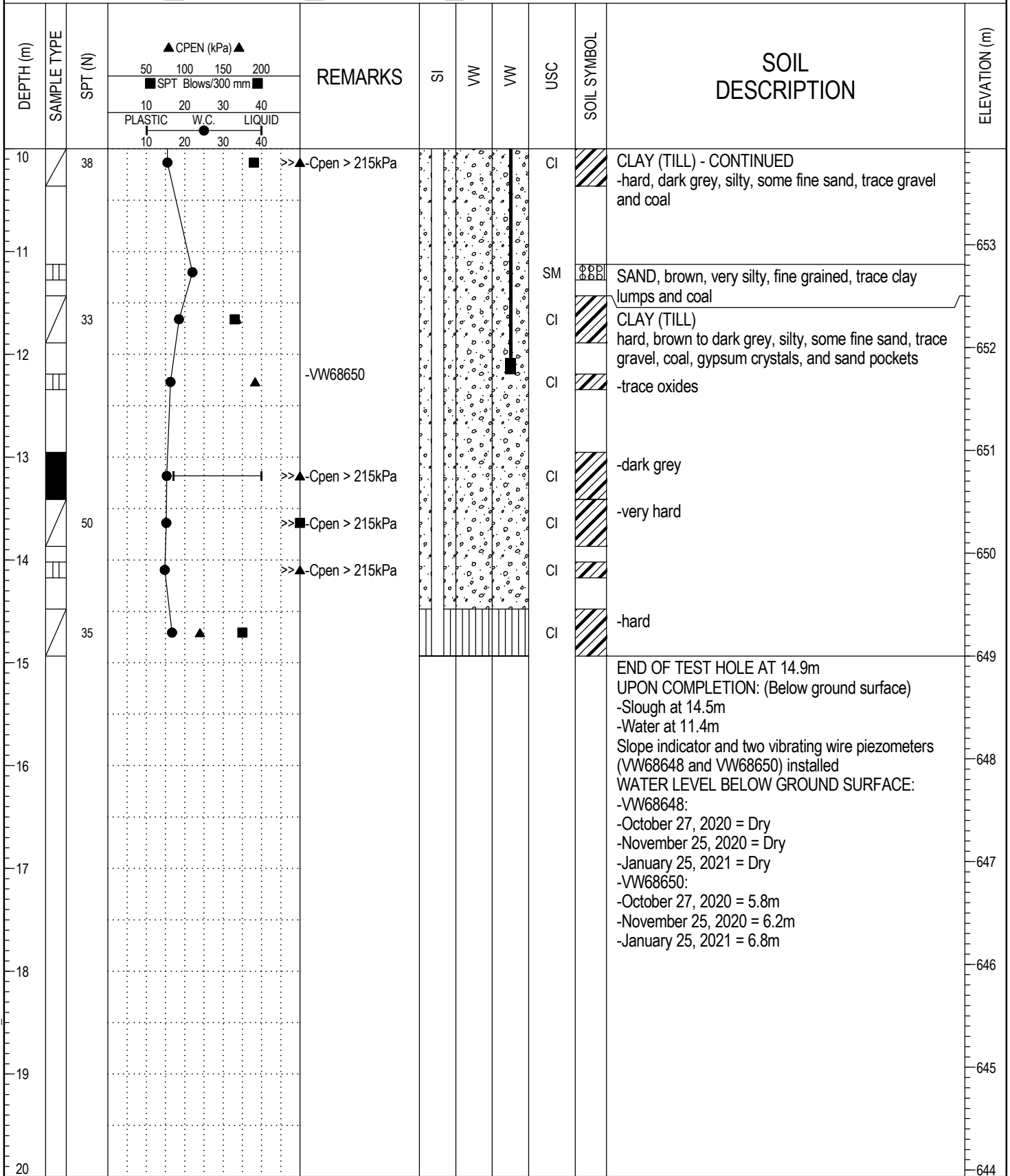
BOREHOLE LOG 28874-VW.GPJ_THRBR_AB.GDT_21-1-27_COPY OF LIBRARY-NEW LOGO-VW.GLB



FIELD LOGGED BY: KAC / GS	COMPLETION DEPTH: 14.9 m
PREPARED BY: SEC	COMPLETION DATE: 20-10-20
REVIEWED BY: TSA	

CLIENT: Associated Engineering Alberta Ltd	PROJECT: WELLINGTON BRIDGE REPLACEMENT	BOREHOLE NO: TH20-4
DRILLING COMPANY: ALL SERVICE DRILLING INC	DATE DRILLED: October 19 & 20, 2020	PROJECT NO: 28874
DRILL/METHOD: Track / Solid Stem Augers	LOCATION: N5934583.839, E29926.275	ELEVATION: 663.93 (m)

SAMPLE TYPE	<input type="checkbox"/> GRAB SAMPLE	<input checked="" type="checkbox"/> SPT	<input type="checkbox"/> SHELBY TUBE
BACKFILL TYPE	<input type="checkbox"/> BENTONITE	<input type="checkbox"/> GROUT	<input type="checkbox"/> SLOUGH



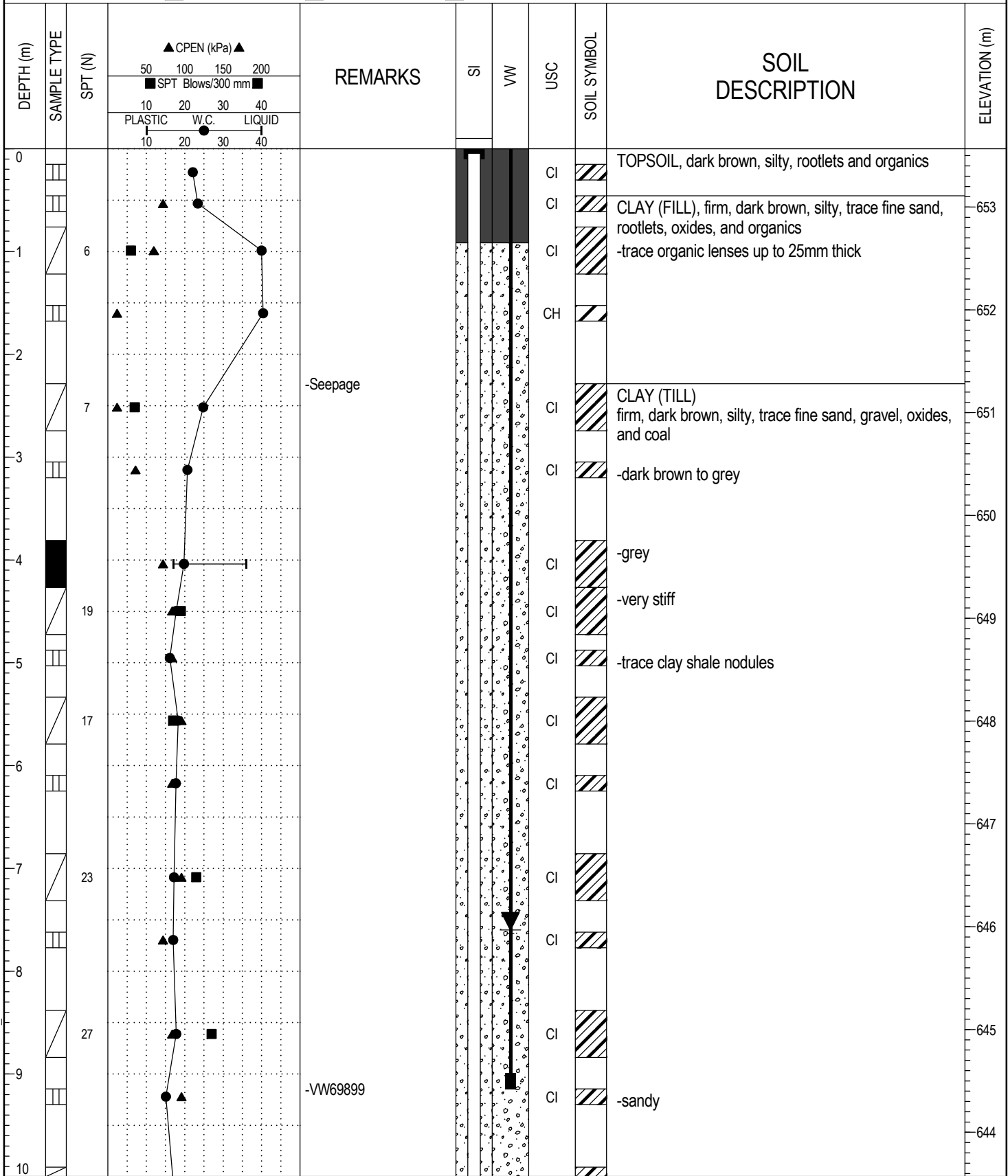
BOREHOLE LOG 28874-VW.GPJ_THRBR_AB.GDT_21-1-27_COPY OF LIBRARY-NEW LOGO-VW.GLB



FIELD LOGGED BY: KAC / GS	COMPLETION DEPTH: 14.9m
PREPARED BY: SEC	COMPLETION DATE: 20-10-20
REVIEWED BY: TSA	

CLIENT: Associated Engineering Alberta Ltd	PROJECT: WELLINGTON BRIDGE REPLACEMENT	BOREHOLE NO: TH20-5
DRILLING COMPANY: ALL SERVICE DRILLING INC	DATE DRILLED: October 19, 2020	PROJECT NO: 28874
DRILL/METHOD: Track / Solid Stem Augers	LOCATION: N5934579.042, E29959.091	ELEVATION: 653.57 (m)

SAMPLE TYPE	<input type="checkbox"/> GRAB SAMPLE	<input checked="" type="checkbox"/> SPT	<input checked="" type="checkbox"/> SHELBY TUBE
BACKFILL TYPE	<input checked="" type="checkbox"/> BENTONITE	<input type="checkbox"/> GROUT	<input type="checkbox"/> SLOUGH



BOREHOLE LOG 28874-VW.GPJ_THRBR_AB.GDT_21-1-27_COPY OF LIBRARY-NEW LOGO-VW.GLB



FIELD LOGGED BY: GS / KAC	COMPLETION DEPTH: 10.4 m
PREPARED BY: SEC	COMPLETION DATE: 20-10-19
REVIEWED BY: TSA	

CLIENT: Associated Engineering Alberta Ltd	PROJECT: WELLINGTON BRIDGE REPLACEMENT	BOREHOLE NO: TH20-5
DRILLING COMPANY: ALL SERVICE DRILLING INC	DATE DRILLED: October 19, 2020	PROJECT NO: 28874
DRILL/METHOD: Track / Solid Stem Augers	LOCATION: N5934579.042, E29959.091	ELEVATION: 653.57 (m)

SAMPLE TYPE	<input type="checkbox"/> GRAB SAMPLE	<input checked="" type="checkbox"/> SPT	<input type="checkbox"/> SHELBY TUBE
BACKFILL TYPE	<input type="checkbox"/> BENTONITE	<input type="checkbox"/> GROUT	<input type="checkbox"/> SLOUGH

DEPTH (m)	SAMPLE TYPE	SPT (N)	REMARKS			SI	VW	USC	SOIL SYMBOL	SOIL DESCRIPTION	ELEVATION (m)
			CPEN (kPa)	SPT Blows/300 mm	PLASTIC W.C. LIQUID						
10		45	<p>▲ CPEN (kPa) ▲</p> <p>50 100 150 200</p> <p>■ SPT Blows/300 mm ■</p> <p>10 20 30 40</p> <p>PLASTIC W.C. LIQUID</p> <p>10 20 30 40</p>				CI	<p>CLAY (TILL) - CONTINUED</p> <p>-hard</p> <p>END OF TEST HOLE AT 10.4m</p> <p>UPON COMPLETION: (Below ground surface)</p> <p>-Slough at 10.1m</p> <p>-Water at 2.0m</p> <p>Slope indicator and vibrating wire piezometer (VW69899) installed</p> <p>WATER LEVEL BELOW GROUND SURFACE:</p> <p>-October 27, 2020 = 5.0m</p> <p>-November 25, 2020 = 6.4m</p> <p>-January 25, 2021 = 7.6m</p>	643		
11										642	
12										641	
13										640	
14										639	
15										638	
16										637	
17										636	
18										635	
19										634	
20										634	

BOREHOLE LOG 28874-VW.GPJ_THRBR_AB.GDT_21-1-27 - COPY OF LIBRARY-NEW LOGO-VW.GLB



FIELD LOGGED BY: GS / KAC	COMPLETION DEPTH: 10.4 m
PREPARED BY: SEC	COMPLETION DATE: 20-10-19
REVIEWED BY: TSA	



APPENDIX D

Laboratory Test Results



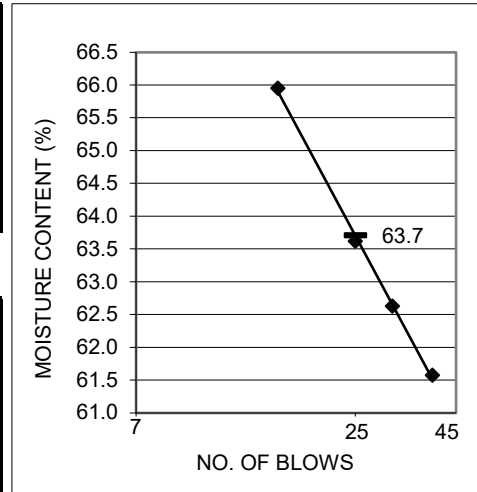
ATTERBERG LIMITS
ASTM D4318

Client: AEAL
Project: Wellington Bridge
Project No: 28874
Test Hole: TH20-1
Sample No: G3
Depth: 1.52 m

Date Tested: 05-Nov-20
Tested By: JAP
Checked By:

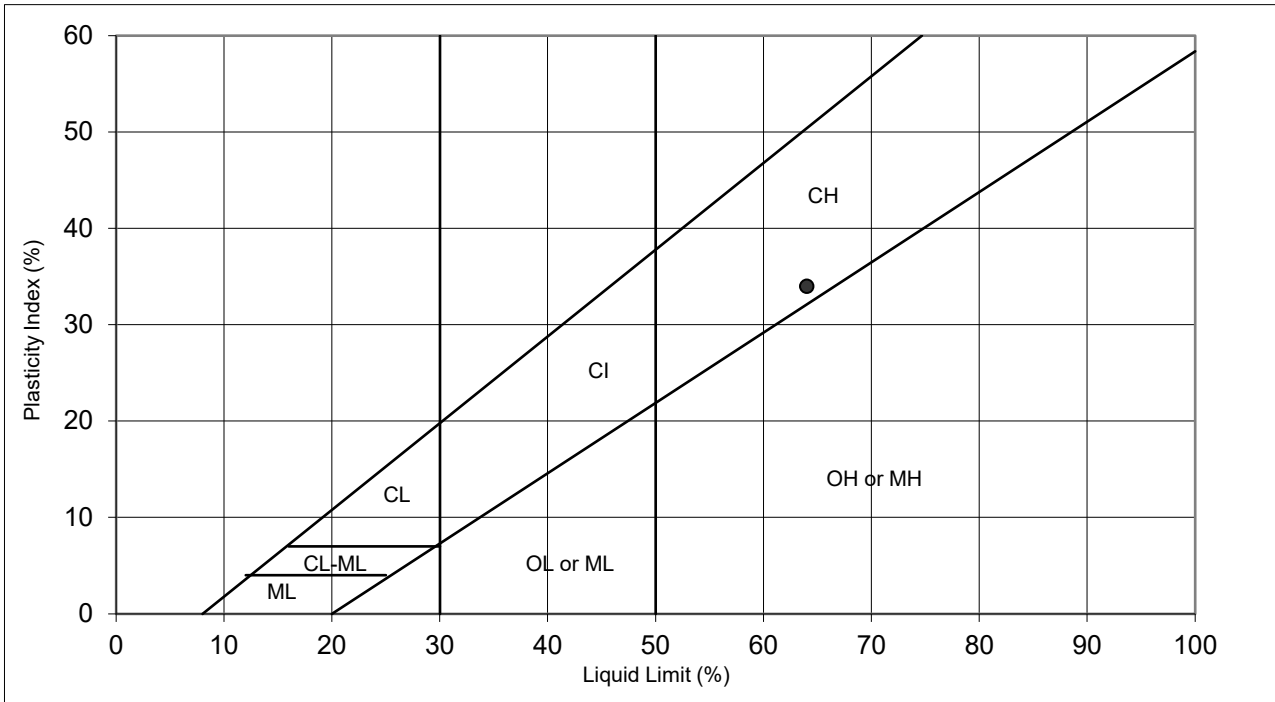
LIQUID LIMIT

Trial No:	1	2	3	4
No of Blows:	39	31	25	16
Container No.	1	2	3	4
Wet Soil + Container	14.38	15.84	18.08	15.5
Dry Soil + Container	8.9	9.74	11.05	9.34
Wt. Of Container	0	0	0	0
Moisture Content	61.6	62.6	63.6	66.0



PLASTIC LIMIT

	1	2	AVERAGE
Container No.	5	6	
Wet Soil + Container	29.5	28.39	
Dry Soil + Container	27.04	26.21	
Wt. Of Container	18.97	19.01	
Moisture Content	30.5	30.3	30.4



REMARKS

Liquid Limit:	64
Plastic Limit:	30
Plasticity Index:	34
USC Classification:	CH



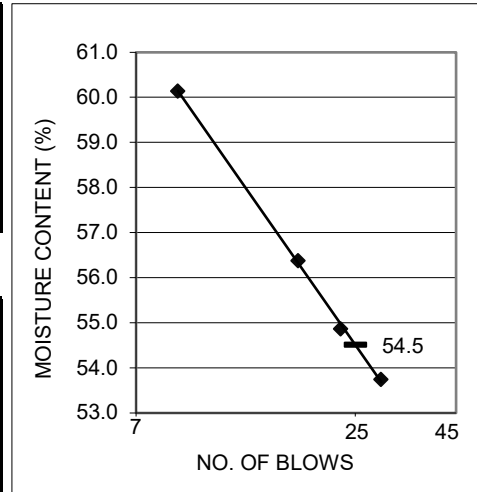
ATTERBERG LIMITS
ASTM D4318

Client: AEAL
Project: Wellington Bridge
Project No: 28874
Test Hole: TH20-1
Sample No: ST6
Depth: 3.81 - 4.27 m

Date Tested: 05-Nov-20
Tested By: JAP
Checked By:

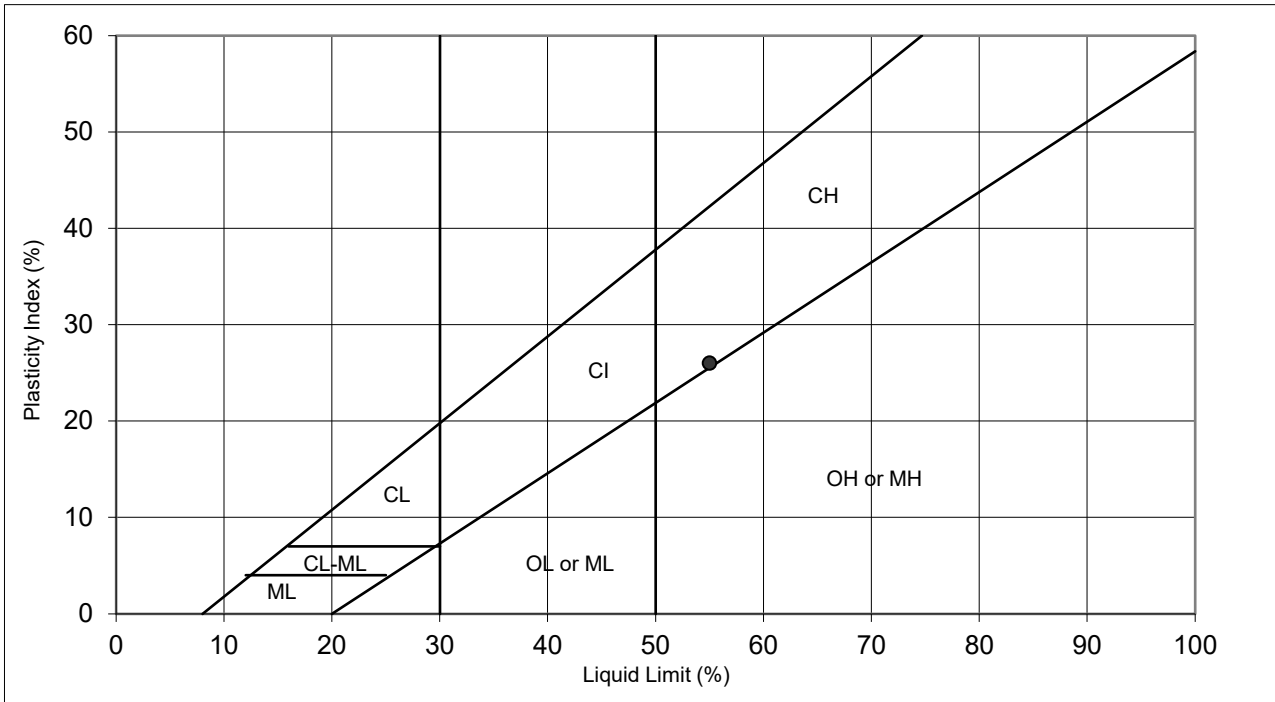
LIQUID LIMIT

Trial No:	1	2	3	4
No of Blows:	29	23	18	9
Container No.	1	2	3	4
Wet Soil + Container	16.45	17.19	16.06	16.51
Dry Soil + Container	10.7	11.10	10.27	10.31
Wt. Of Container	0	0	0	0
Moisture Content	53.7	54.9	56.4	60.1



PLASTIC LIMIT

	1	2	AVERAGE
Container No.	5	6	
Wet Soil + Container	28.13	30.56	
Dry Soil + Container	26.02	27.90	
Wt. Of Container	18.77	18.8	
Moisture Content	29.1	29.2	29.2



REMARKS

Liquid Limit:	55
Plastic Limit:	29
Plasticity Index:	26
USC Classification:	CH



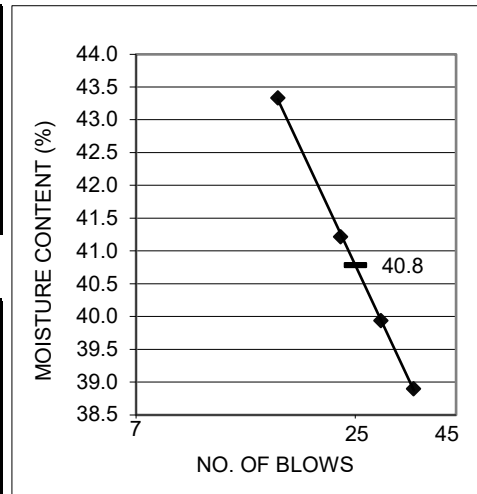
ATTERBERG LIMITS
ASTM D4318

Client: AEAL
Project: Wellington Bridge
Project No: 28874
Test Hole: TH20-1
Sample No: ST19
Depth: 12.95 - 13.41 m

Date Tested: 05-Nov-20
Tested By: JAP
Checked By:

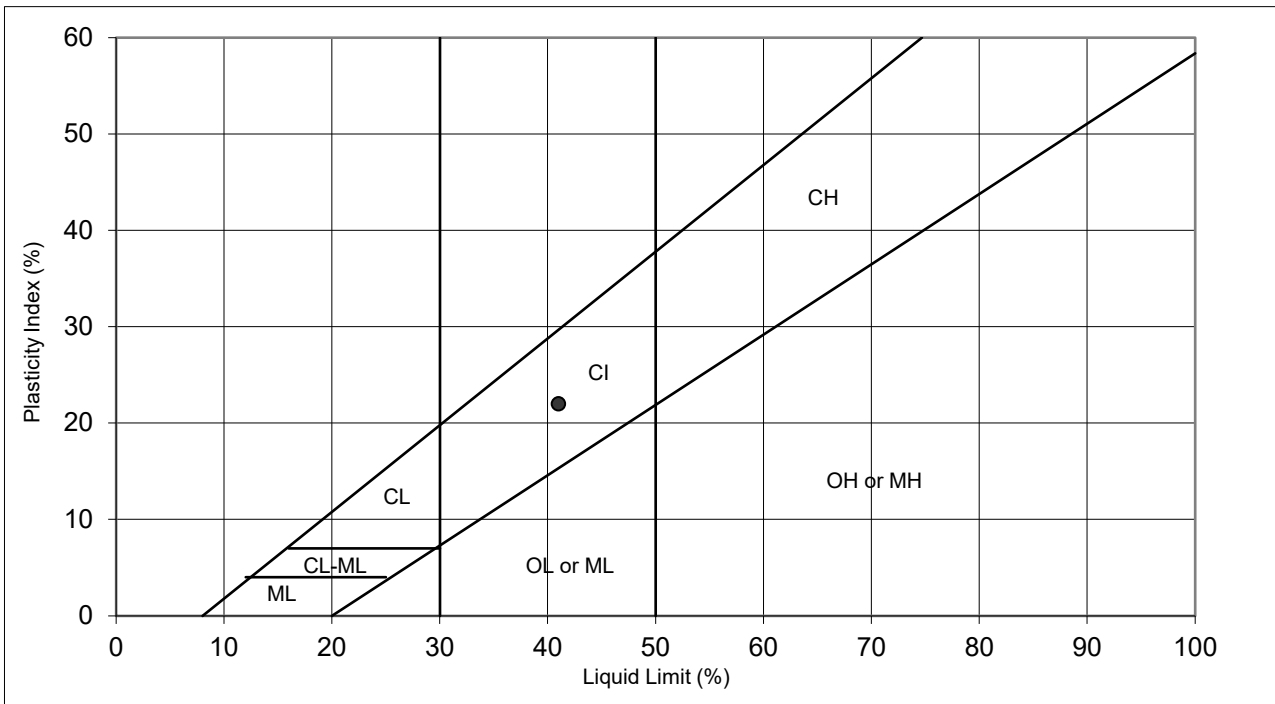
LIQUID LIMIT

Trial No:	1	2	3	4
No of Blows:	35	29	23	16
Container No.	1	2	3	4
Wet Soil + Container	17.89	17.80	17.2	17.53
Dry Soil + Container	12.88	12.72	12.18	12.23
Wt. Of Container	0	0	0	0
Moisture Content	38.9	39.9	41.2	43.3



PLASTIC LIMIT

	1	2	AVERAGE
Container No.	5	6	
Wet Soil + Container	29.27	29.72	
Dry Soil + Container	27.62	28.01	
Wt. Of Container	18.84	19.01	
Moisture Content	18.8	19.0	18.9



REMARKS

Liquid Limit:	41
Plastic Limit:	19
Plasticity Index:	22
USC Classification:	CI



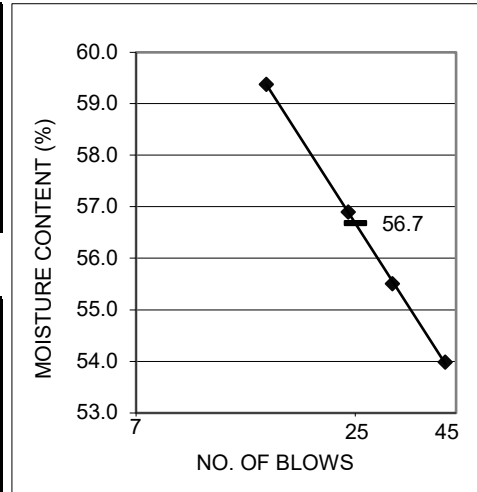
ATTERBERG LIMITS
ASTM D4318

Client: AEAL
Project: Wellington Bridge
Project No: 28874
Test Hole: TH20-2
Sample No: ST6
Depth: 3.81 - 4.27 m

Date Tested: 31-Oct-20
Tested By: NM
Checked By:

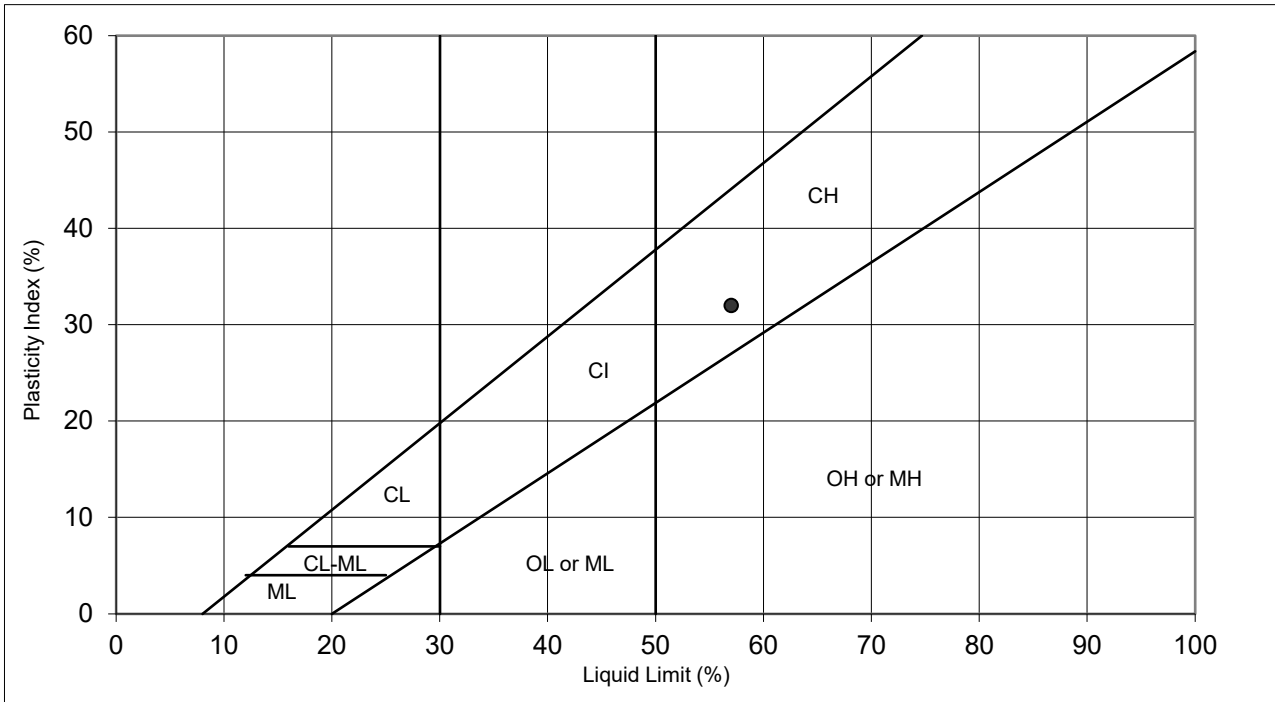
LIQUID LIMIT

Trial No:	1	2	3	4
No of Blows:	42	31	24	15
Container No.	1	2	3	4
Wet Soil + Container	12.18	13.84	13.54	13.34
Dry Soil + Container	7.91	8.90	8.63	8.37
Wt. Of Container	0	0	0	0
Moisture Content	54.0	55.5	56.9	59.4



PLASTIC LIMIT

	1	2	AVERAGE
Container No.	5	6	
Wet Soil + Container	28.54	28.33	
Dry Soil + Container	26.58	26.39	
Wt. Of Container	18.87	18.79	
Moisture Content	25.4	25.5	25.5



REMARKS

Liquid Limit:	57
Plastic Limit:	25
Plasticity Index:	32
USC Classification:	CH



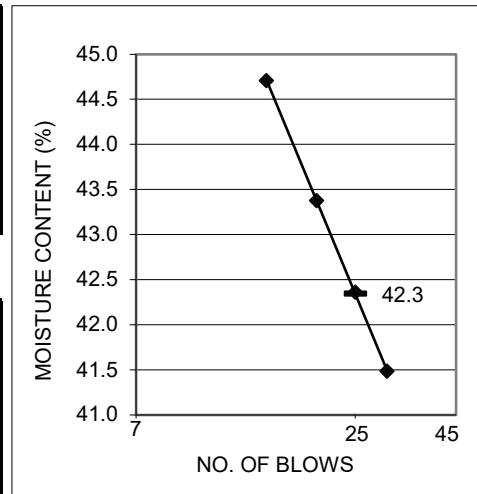
ATTERBERG LIMITS
ASTM D4318

Client: AEAL
Project: Wellington Bridge
Project No: 28874
Test Hole: TH20-2
Sample No: ST24
Depth: 16.00 - 16.46 m

Date Tested: 31-Oct-20
Tested By: NM
Checked By:

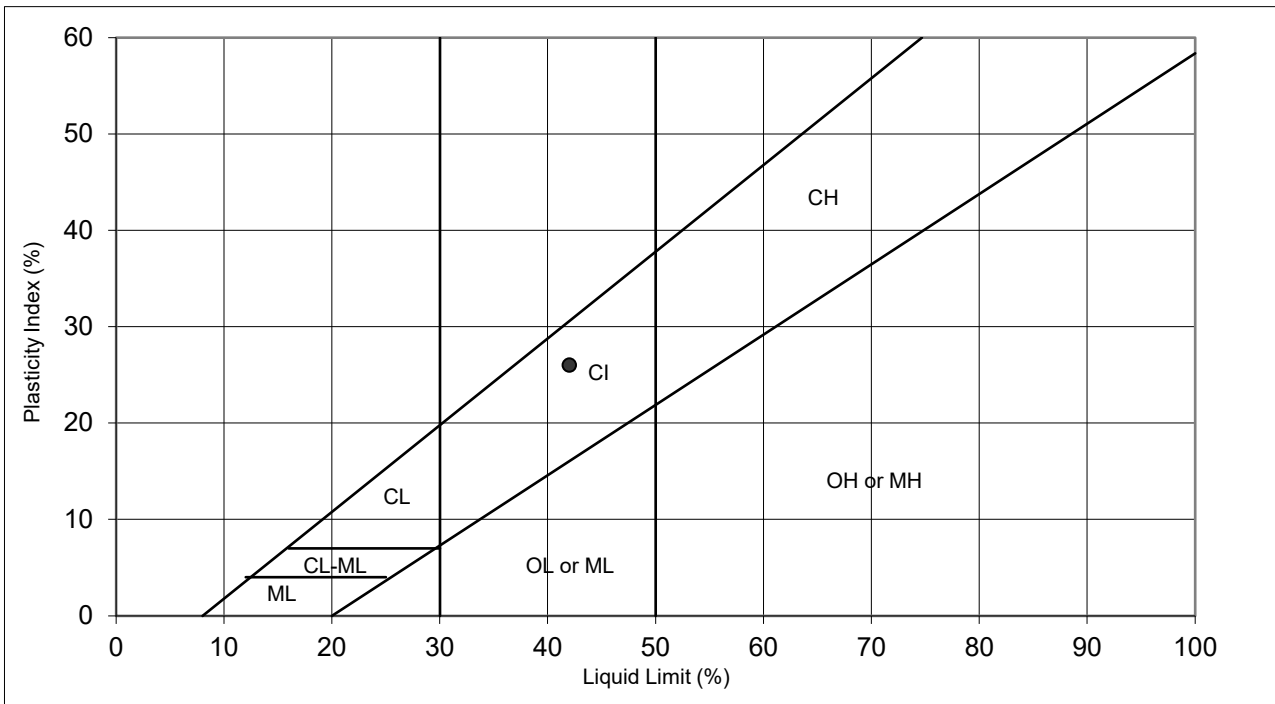
LIQUID LIMIT

Trial No:	1	2	3	4
No of Blows:	30	25	20	15
Container No.	1	2	3	4
Wet Soil + Container	12.96	13.14	12.23	13.4
Dry Soil + Container	9.16	9.23	8.53	9.26
Wt. Of Container	0	0	0	0
Moisture Content	41.5	42.4	43.4	44.7



PLASTIC LIMIT

	1	2	AVERAGE
Container No.	5	6	
Wet Soil + Container	28.44	27.93	
Dry Soil + Container	27.1	26.63	
Wt. Of Container	18.95	18.75	
Moisture Content	16.4	16.5	16.5



REMARKS

Liquid Limit:	42
Plastic Limit:	16
Plasticity Index:	26
USC Classification:	CI



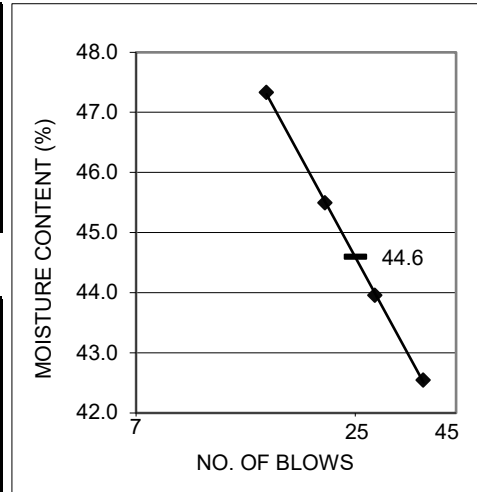
ATTERBERG LIMITS
ASTM D4318

Client: AEAL
Project: Wellington Bridge
Project No: 28874
Test Hole: TH20-3
Sample No: G3
Depth: 1.52 m

Date Tested: 01-Oct-20
Tested By: JAP
Checked By:

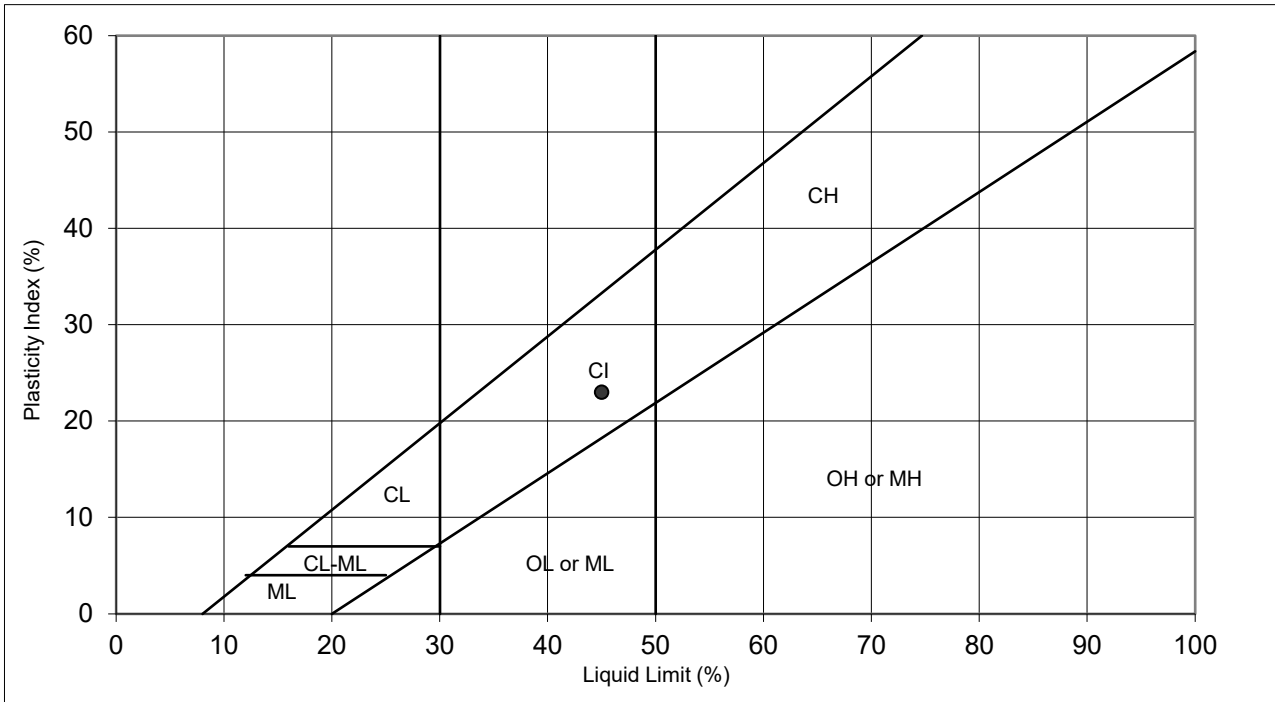
LIQUID LIMIT

Trial No:	1	2	3	4
No of Blows:	37	28	21	15
Container No.	1	2	3	4
Wet Soil + Container	16.92	18.11	16.47	16.28
Dry Soil + Container	11.87	12.58	11.32	11.05
Wt. Of Container	0	0	0	0
Moisture Content	42.5	44.0	45.5	47.3



PLASTIC LIMIT

	1	2	AVERAGE
Container No.	5	6	
Wet Soil + Container	31.17	28.94	
Dry Soil + Container	28.95	27.10	
Wt. Of Container	18.87	18.81	
Moisture Content	22.0	22.2	22.1



REMARKS

Liquid Limit:	45
Plastic Limit:	22
Plasticity Index:	23
USC Classification:	CI



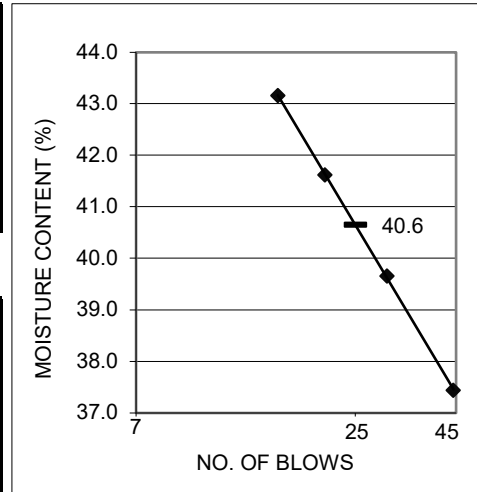
ATTERBERG LIMITS
ASTM D4318

Client: AEAL
Project: Wellington Bridge
Project No: 28874
Test Hole: TH20-3
Sample No: G12
Depth: 7.62 m

Date Tested: 01-Oct-20
Tested By: NM
Checked By:

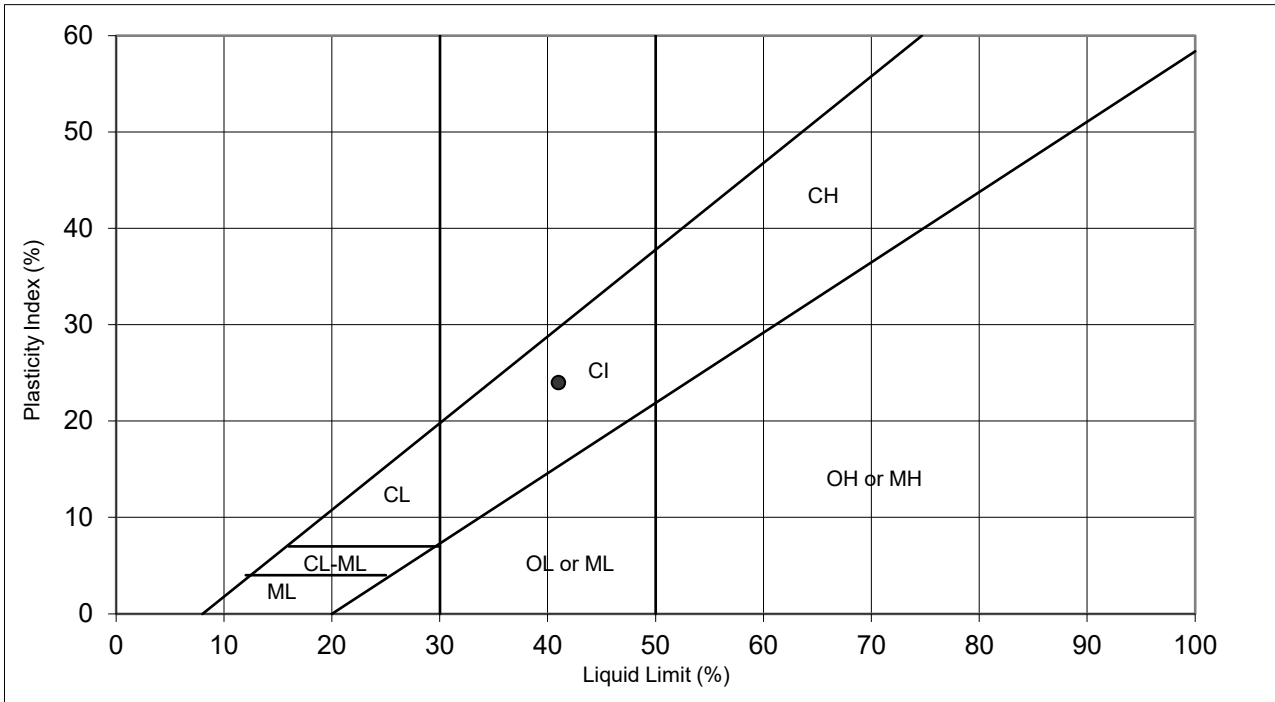
LIQUID LIMIT

Trial No:	1	2	3	4
No of Blows:	44	30	21	16
Container No.	1	2	3	4
Wet Soil + Container	13.51	13.03	12.76	12.24
Dry Soil + Container	9.83	9.33	9.01	8.55
Wt. Of Container	0	0	0	0
Moisture Content	37.4	39.7	41.6	43.2



PLASTIC LIMIT

	1	2	AVERAGE
Container No.	5	6	
Wet Soil + Container	28.1	28.13	
Dry Soil + Container	26.77	26.78	
Wt. Of Container	18.75	18.69	
Moisture Content	16.6	16.7	16.6



REMARKS

Liquid Limit:	41
Plastic Limit:	17
Plasticity Index:	24
USC Classification:	CI



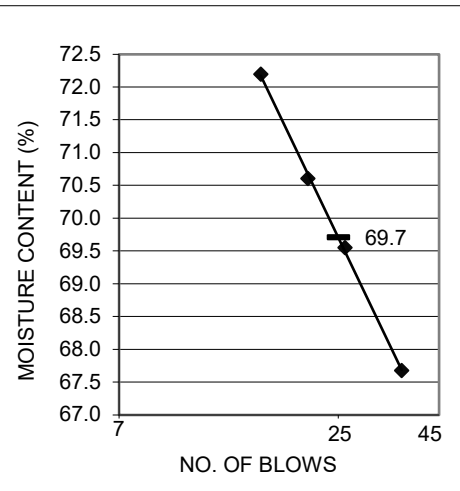
ATTERBERG LIMITS
ASTM D4318

Client: AEAL
Project: Wellington Bridge
Project No: 28874
Test Hole: TH20-4
Sample No: ST7
Depth: 3.81 - 4.27 m

Date Tested: 31-Oct-20
Tested By: NM
Checked By:

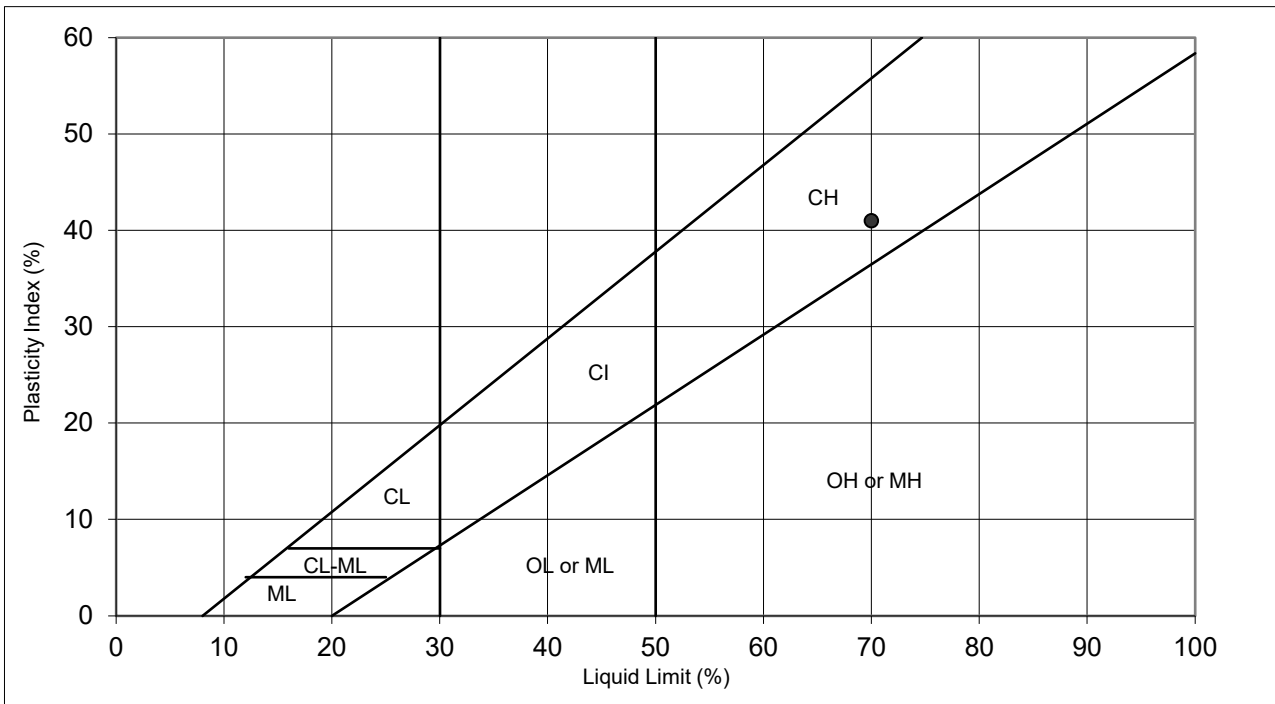
LIQUID LIMIT

Trial No:	1	2	3	4
No of Blows:	36	26	21	16
Container No.	1	2	3	4
Wet Soil + Container	13.85	14.31	13.29	13.19
Dry Soil + Container	8.26	8.44	7.79	7.66
Wt. Of Container	0	0	0	0
Moisture Content	67.7	69.5	70.6	72.2



PLASTIC LIMIT

	1	2	AVERAGE
Container No.	5	6	
Wet Soil + Container	28.3	28.32	
Dry Soil + Container	26.12	26.17	
Wt. Of Container	18.66	18.81	
Moisture Content	29.2	29.2	29.2



REMARKS

Liquid Limit:	70
Plastic Limit:	29
Plasticity Index:	41
USC Classification:	CH



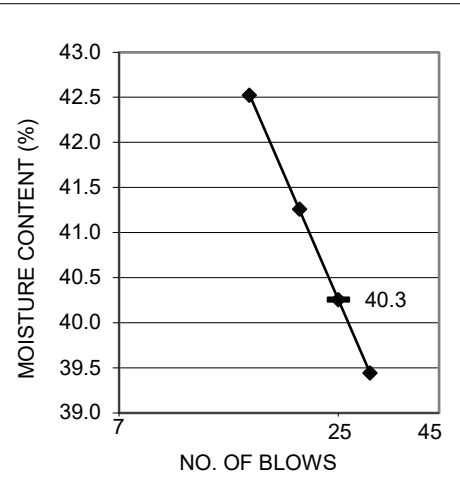
ATTERBERG LIMITS
ASTM D4318

Client: AEAL
Project: Wellington Bridge
Project No: 28874
Test Hole: TH20-4
Sample No: ST20
Depth: 12.95 - 13.41 m

Date Tested: 31-Oct-20
Tested By: NM
Checked By:

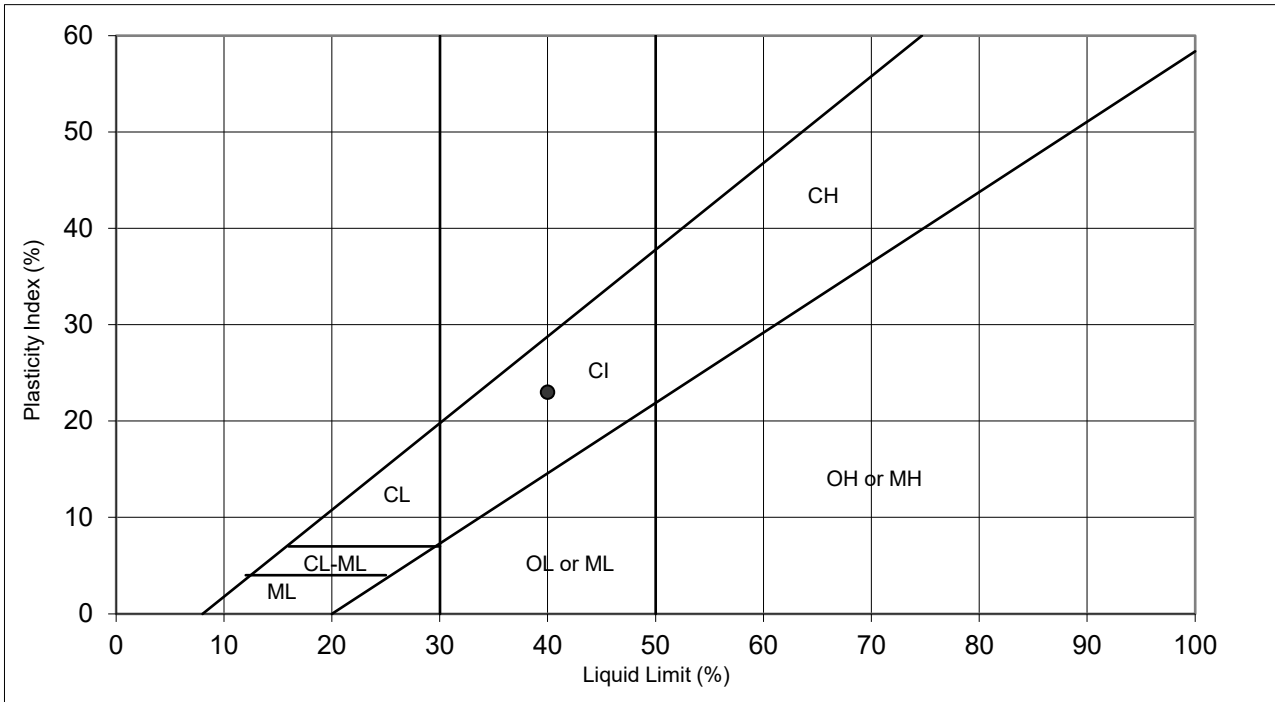
LIQUID LIMIT

Trial No:	1	2	3	4
No of Blows:	30	25	20	15
Container No.	1	2	3	4
Wet Soil + Container	14	13.17	14.14	13.34
Dry Soil + Container	10.04	9.39	10.01	9.36
Wt. Of Container	0	0	0	0
Moisture Content	39.4	40.3	41.3	42.5



PLASTIC LIMIT

	1	2	AVERAGE
Container No.	5	6	
Wet Soil + Container	28.24	28.45	
Dry Soil + Container	26.91	27.08	
Wt. Of Container	18.9	18.8	
Moisture Content	16.6	16.5	16.6



REMARKS

Liquid Limit:	40
Plastic Limit:	17
Plasticity Index:	23
USC Classification:	CI



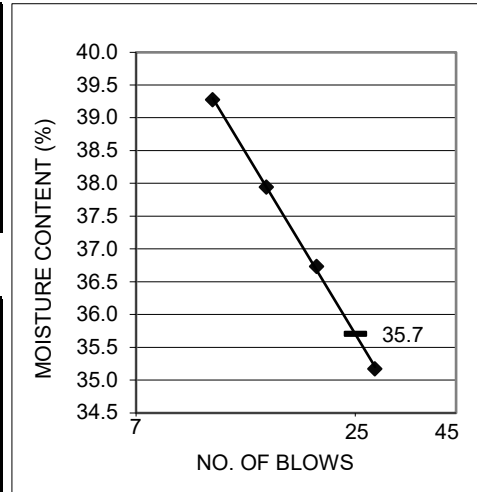
ATTERBERG LIMITS
ASTM D4318

Client: AEAL
Project: Wellington Bridge
Project No: 28874
Test Hole: TH20-5
Sample No: ST7
Depth: 3.81 - 4.27 m

Date Tested: 05-Nov-20
Tested By: JAP
Checked By:

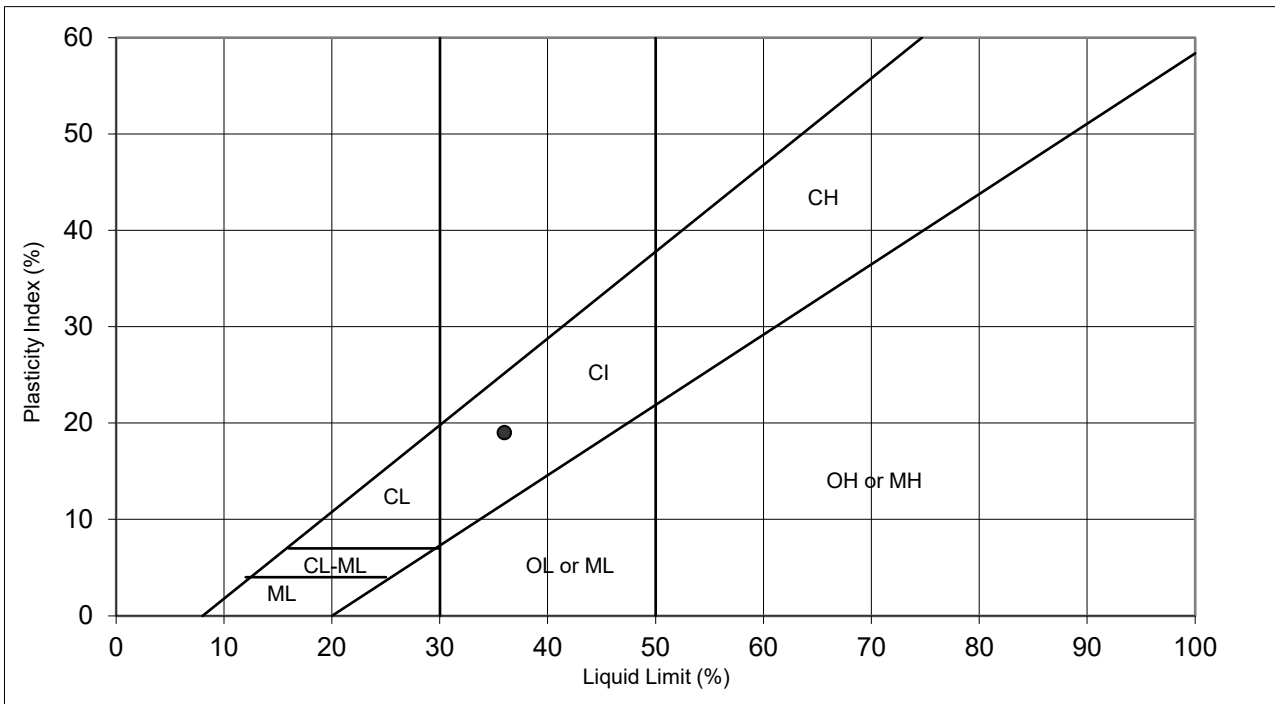
LIQUID LIMIT

Trial No:	1	2	3	4
No of Blows:	28	20	15	11
Container No.	1	2	3	4
Wet Soil + Container	17.91	17.57	16.76	16.17
Dry Soil + Container	13.25	12.85	12.15	11.61
Wt. Of Container	0	0	0	0
Moisture Content	35.2	36.7	37.9	39.3



PLASTIC LIMIT

	1	2	AVERAGE
Container No.	5	6	
Wet Soil + Container	29.61	30.81	
Dry Soil + Container	28	29.01	
Wt. Of Container	18.71	18.71	
Moisture Content	17.3	17.5	17.4



REMARKS

Liquid Limit:	36
Plastic Limit:	17
Plasticity Index:	19
USC Classification:	CI



SIEVE ANALYSIS REPORT

THURBER ENGINEERING LTD.

4127 Roper Road Edmonton, Alberta T6B 3S5 P: 780.438.1460 F: 780.437.7125

Client: AEAL

Project No.: 28874

Project: Wellington Bridge

Date: 29-Oct-20

Sample Source: TH20-1 G40 @ 27.43 m

Date Tested: 29-Oct-20

Material Type:

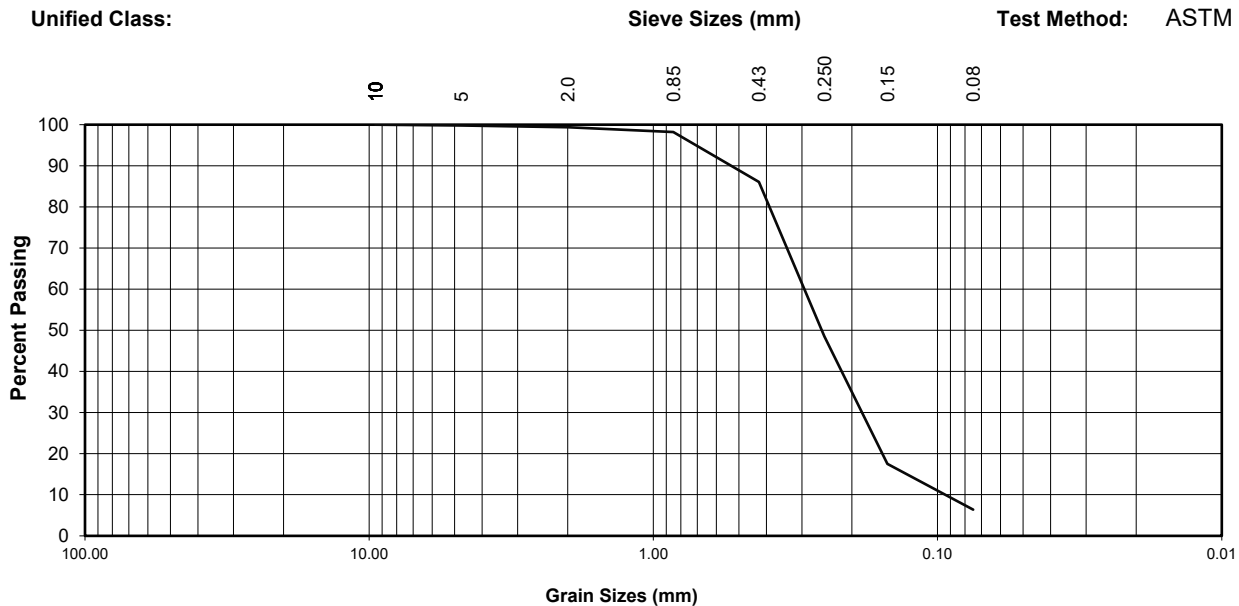
Sampled by: n/a

Specification:

Date Sampled: n/a

Unified Class:

Test Method: ASTM C 136



Sieve No.	Opening (mm)	Percent Passing	Gradation Limits	
			Max	Min
3/8 ins	9.5	100.0		
#4	4.75	99.8		
#10	2	99.4		
#20	0.85	98.2		
#40	0.425	86.1		
#60	0.25	48.5		
#100	0.15	17.5		
#200	0.075	6.4		

Total Sample Proportions	
Gravel:	0.2 %
Sand:	93.4 %
Fines:	6.4 %

Silt and Clay	
Silt	-
Clay	-
Total Fines:	

Moisture Content
As Received: 4.4%

Percent Crush: -
Faces Counted:

Computer File : TH20-1 G40
Series No.: n/a

Comments:

Checked By:



SIEVE ANALYSIS REPORT

THURBER ENGINEERING LTD.

4127 Roper Road Edmonton, Alberta T6B 3S5 P: 780.438.1460 F: 780.437.7125

Client: AEAL

Project No.: 28874

Project: Wellington Bridge

Date: 04-Nov-20

Sample Source: TH20-2 P40 @ 30.48 - 30.64 m

Date Tested: 04-Nov-20

Material Type:

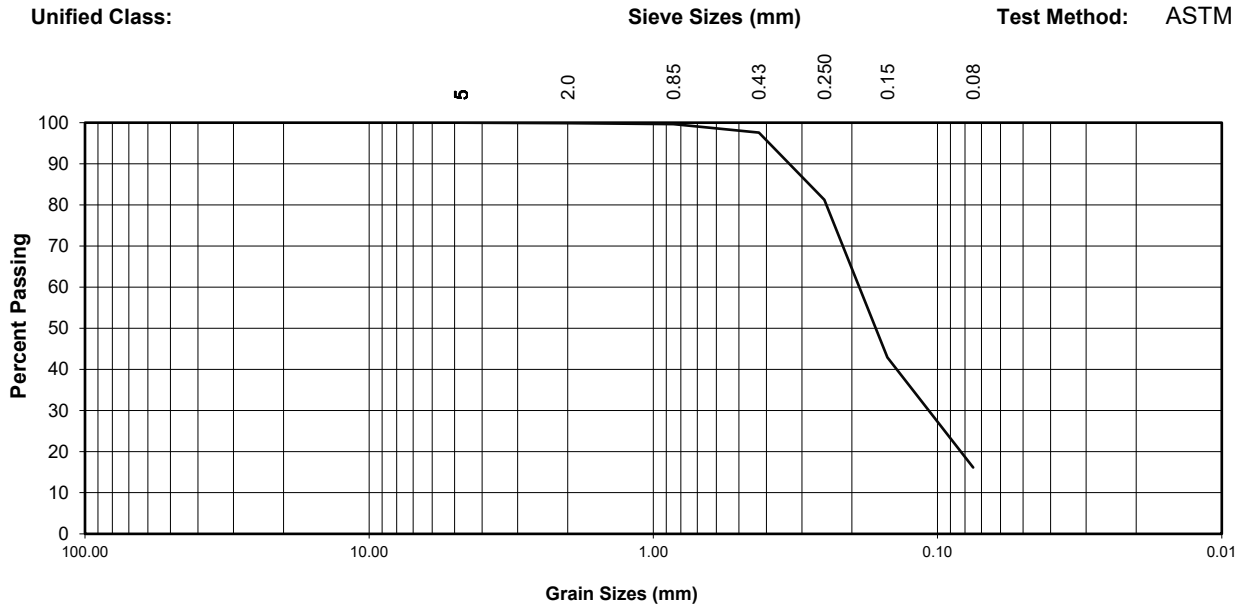
Sampled by: N/A

Specification:

Date Sampled: N/A

Unified Class:

Test Method: ASTM C 136



Sieve No.	Opening (mm)	Percent Passing	Gradation Limits	
			Max	Min
#4	4.75	100.0		
#10	2	99.9		
#20	0.85	99.7		
#40	0.425	97.6		
#60	0.25	81.2		
#100	0.15	42.9		
#200	0.075	16.2		

Total Sample Proportions	
Gravel:	0.0 %
Sand:	83.8 %
Fines:	16.2 %

Silt and Clay	
Silt	-
Clay	-
Total Fines:	

Moisture Content

As Received: 17.1%

Percent Crush: -

Faces Counted:

Computer File : TH20-2 P40

Series No.: N/A

Comments:

Checked By:



SIEVE ANALYSIS REPORT

THURBER ENGINEERING LTD.

4127 Roper Road Edmonton, Alberta T6B 3S5 P: 780.438.1460 F: 780.437.7125

Client: AEAL

Project No.: 28874

Project: Wellington Bridge

Date: 04-Nov-20

Sample Source: TH20-3 P21 @ 16.00 - 16.46 m

Date Tested: 04-Nov-20

Material Type:

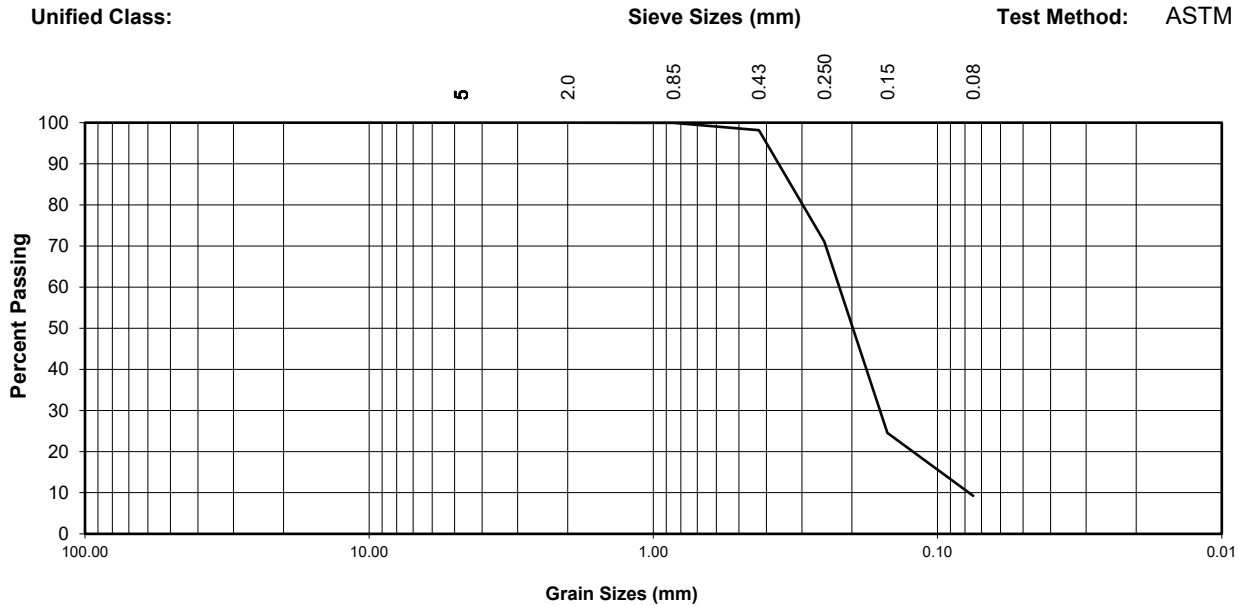
Sampled by: N/A

Specification:

Date Sampled: N/A

Unified Class:

Test Method: ASTM C 136



Sieve No.	Opening (mm)	Percent Passing	Gradation Limits	
			Max	Min
#4	4.75	100.0		
#10	2	100.0		
#20	0.85	100.0		
#40	0.425	98.2		
#60	0.25	71.0		
#100	0.15	24.5		
#200	0.075	9.3		

Total Sample Proportions	
Gravel:	0.0 %
Sand:	90.7 %
Fines:	9.3 %

Silt and Clay	
Silt	-
Clay	-
Total Fines:	

Moisture Content
As Received: 3.5%

Percent Crush: -
Faces Counted:

Computer File : TH20-3 P21
Series No.: N/A

Comments:

Checked By:

THURBER ENGINEERING LTD. UNCONFINED COMPRESSION TEST REPORT

AEAL
FILE NUMBER : 28874

REPORT DATE: Sept 30/20
REPORT NUMBER: UC20-1

Wellington Bridge

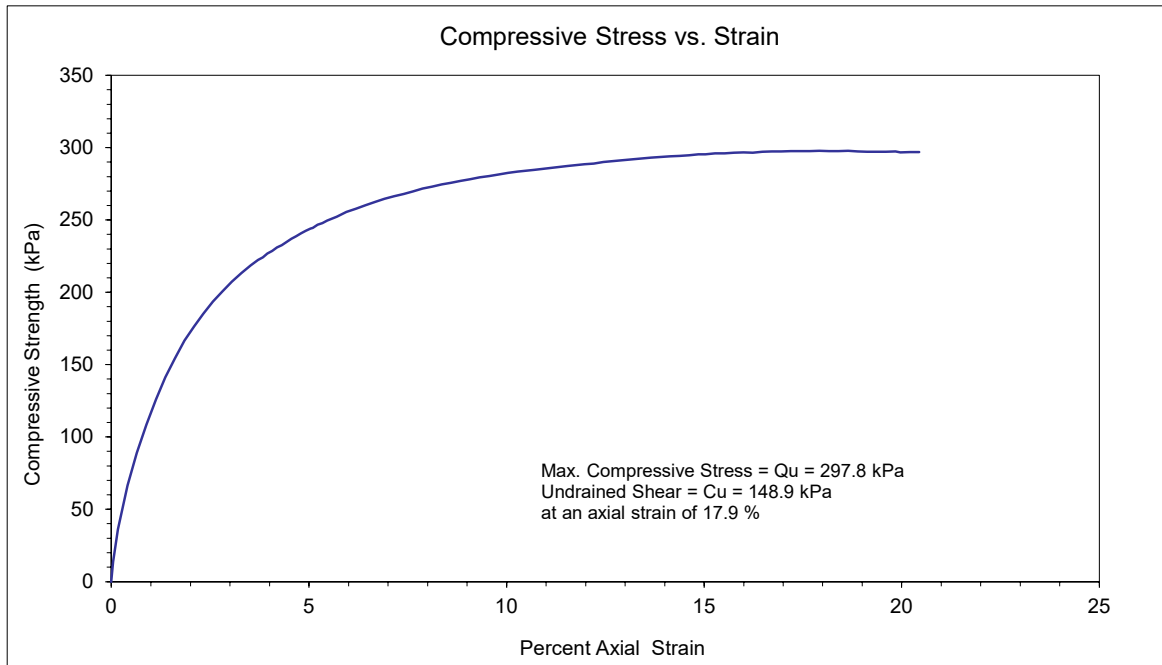
TEST DATE: Sept 30/20
SAMPLE: TH20-3 @ 5.33 - 5.79 m
DESCRIPTION: Clay till (CI), silty, some sand, trace coal, pebbles, claystone nodules, grey.

SPECIMEN DETAILS:

Wet Density (kg/m³): 2153
Dry Density (kg/m³): 1843
Moisture Content (%): 16.8

Liquid Limit (%): -
Plastic Limit (%): -
Plasticity Index (%): -

Gravel (%): -
Sand (%): -
Silt (%): -
Clay (%): -



THURBER ENGINEERING LTD. UNCONFINED COMPRESSION TEST REPORT

AEAL
FILE NUMBER : 28874

REPORT DATE: Sept 30/20
REPORT NUMBER: UC20-2

Wellington Bridge

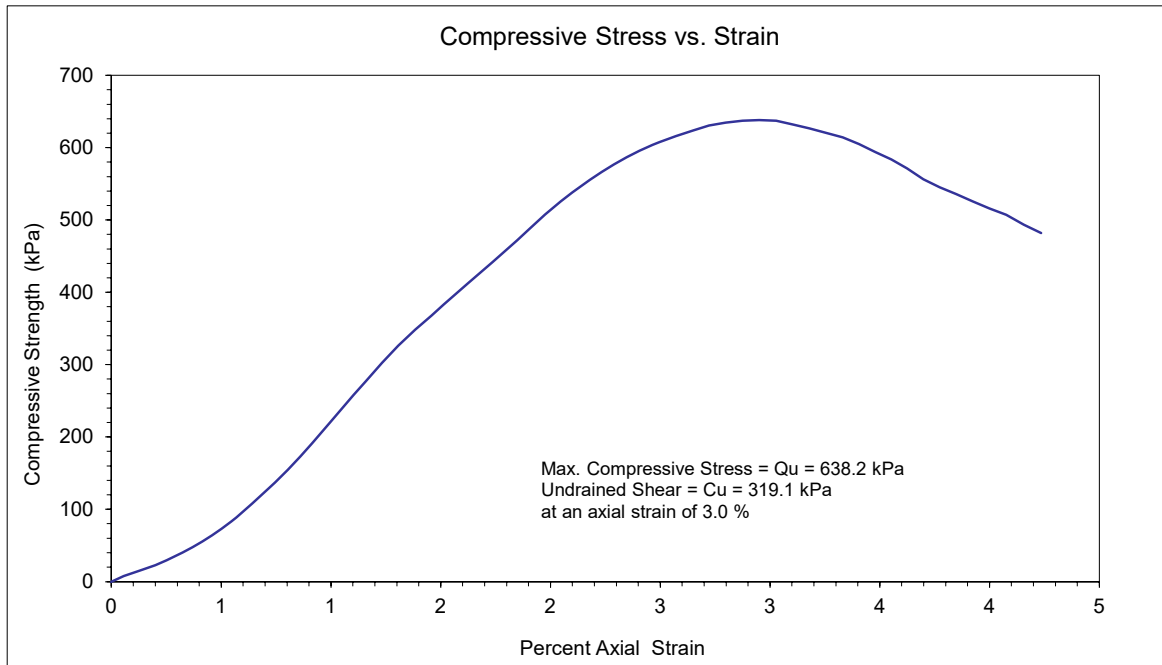
TEST DATE: Sept 30/20
SAMPLE: TH20-3 @ 36.01 - 36.14 m
DESCRIPTION: Clay Shale (CH), silty, trace siltstone inclusions, grey.

SPECIMEN DETAILS:

Wet Density (kg/m³): 2108
Dry Density (kg/m³): 1809
Moisture Content (%): 16.5

Liquid Limit (%): -
Plastic Limit (%): -
Plasticity Index (%): -

Gravel (%): -
Sand (%): -
Silt (%): -
Clay (%): -



THURBER ENGINEERING LTD. UNCONFINED COMPRESSION TEST REPORT

AEAL
FILE NUMBER : 28874

REPORT DATE: Sept 30/20
REPORT NUMBER: UC20-3

Wellington Bridge

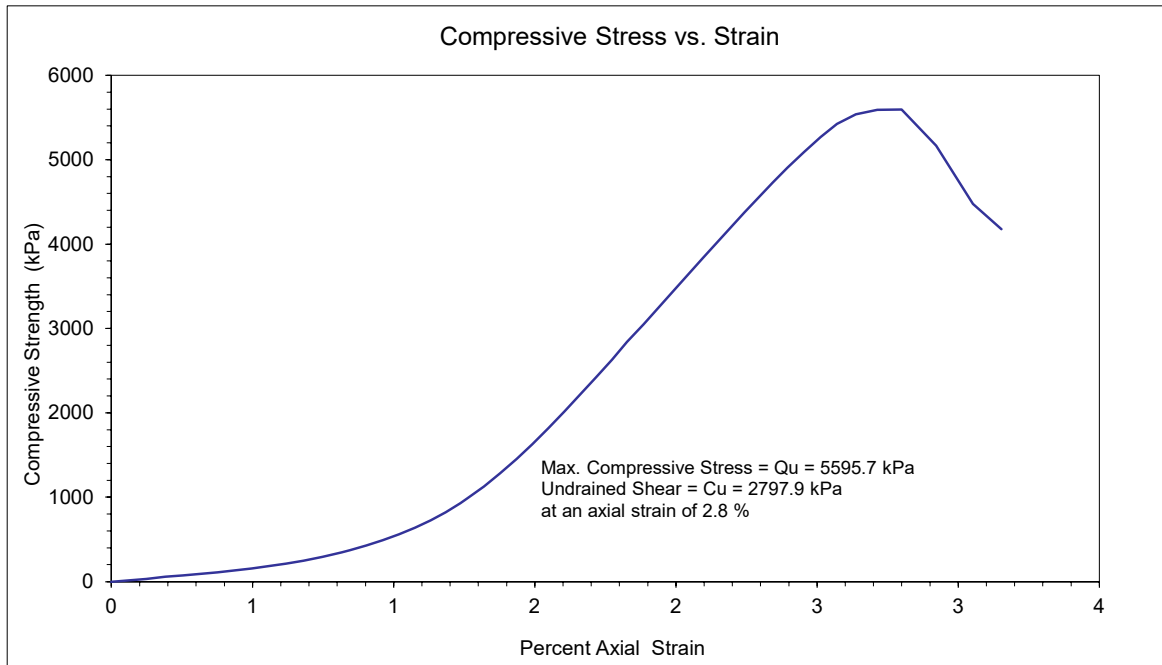
TEST DATE: Sept 30/20
SAMPLE: TH20-3 @ 40.35 - 40.47 m
DESCRIPTION: Clay Shale (Cl), very silty, trace siltstone inclusion, coal, grey.

SPECIMEN DETAILS:

Wet Density (kg/m³): 2189
Dry Density (kg/m³): 1957
Moisture Content (%): 11.8

Liquid Limit (%): -
Plastic Limit (%): -
Plasticity Index (%): -

Gravel (%): -
Sand (%): -
Silt (%): -
Clay (%): -



THURBER ENGINEERING LTD. UNCONFINED COMPRESSION TEST REPORT

AEAL
FILE NUMBER : 28874

REPORT DATE: Oct 29/20
REPORT NUMBER: UC20-4

Wellington Bridge

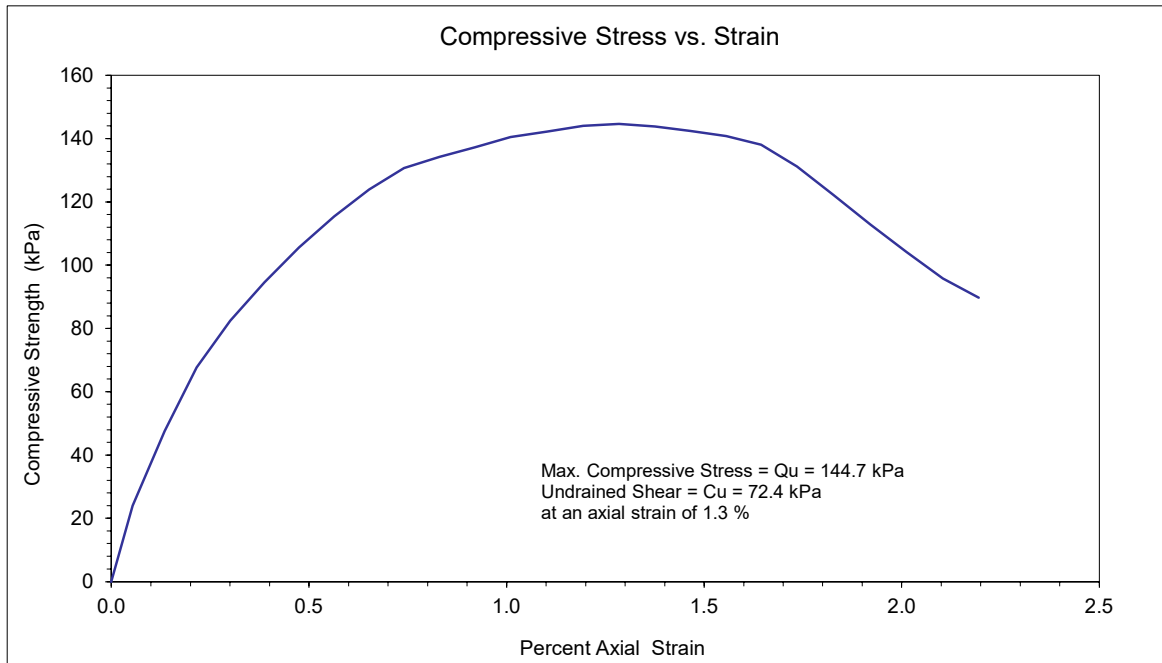
TEST DATE: Oct 27/20
SAMPLE: TH20-1 @ 3.81 - 4.27 m
DESCRIPTION: Clay (CH), silty, trace silt lenses, coal, oxides, brown and grey.

SPECIMEN DETAILS:

Wet Density (kg/m³): 1907
Dry Density (kg/m³): 1452
Moisture Content (%): 31.3

Liquid Limit (%): -
Plastic Limit (%): -
Plasticity Index (%): -

Gravel (%): -
Sand (%): -
Silt (%): -
Clay (%): -



THURBER ENGINEERING LTD. UNCONFINED COMPRESSION TEST REPORT

AEAL
FILE NUMBER : 28874

REPORT DATE: Oct 28/20
REPORT NUMBER: UC20-5

Wellington Bridge

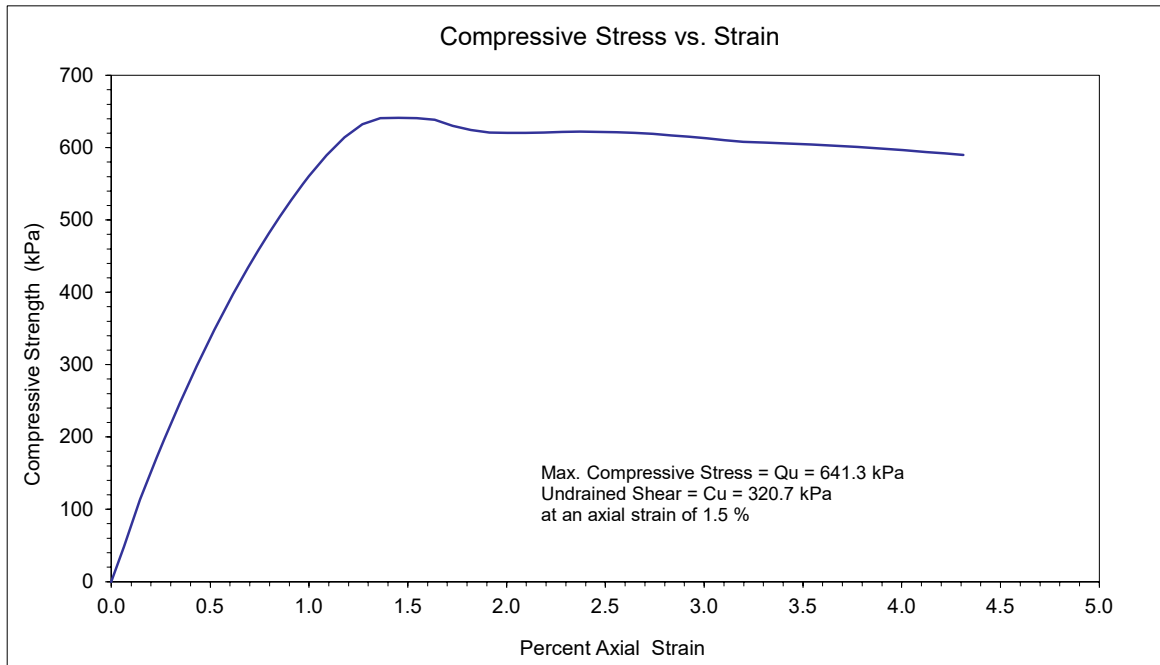
TEST DATE: Oct 27/20
 SAMPLE: TH20-1 @ 12.95 - 13.41 m
 DESCRIPTION: Clay till (Cl), sandy, silty, trace coal, oxides, gravel, gypsum, claystone nodules, brown and grey.

SPECIMEN DETAILS:

Wet Density (kg/m³): 2170
 Dry Density (kg/m³): 1875
 Moisture Content (%): 15.7

Liquid Limit (%): -
 Plastic Limit (%): -
 Plasticity Index (%): -

Gravel (%): -
 Sand (%): -
 Silt (%): -
 Clay (%): -



THURBER ENGINEERING LTD. UNCONFINED COMPRESSION TEST REPORT

AEAL
FILE NUMBER : 28874

REPORT DATE: Oct 28/20
REPORT NUMBER: UC20-6

Wellington Bridge

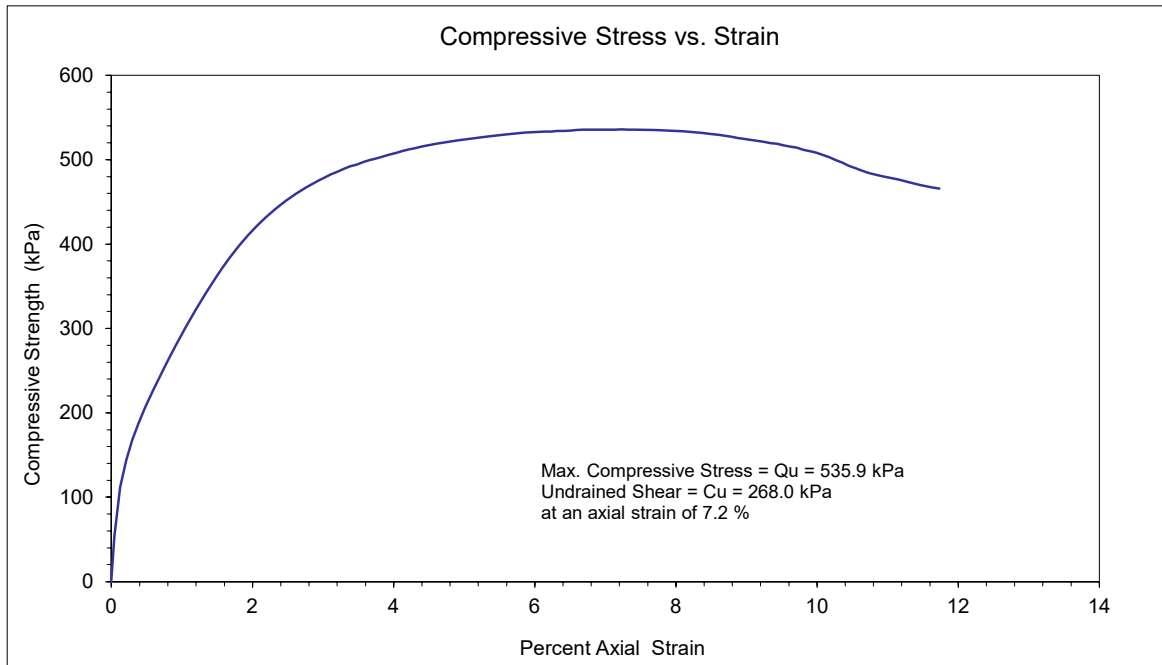
TEST DATE: Oct 27/20
SAMPLE: TH20-2 @ 16.00 - 16.46 m
DESCRIPTION: Clay till (CI), sandy, silty, trace coal, gravel, oxides, claystone nodules, grey.

SPECIMEN DETAILS:

Wet Density (kg/m³): 2187
Dry Density (kg/m³): 1901
Moisture Content (%): 15.0

Liquid Limit (%): -
Plastic Limit (%): -
Plasticity Index (%): -

Gravel (%): -
Sand (%): -
Silt (%): -
Clay (%): -



THURBER ENGINEERING LTD. UNCONFINED COMPRESSION TEST REPORT

AEAL
FILE NUMBER : 28874

REPORT DATE: Oct 29/20
REPORT NUMBER: UC20-7

Wellington Bridge

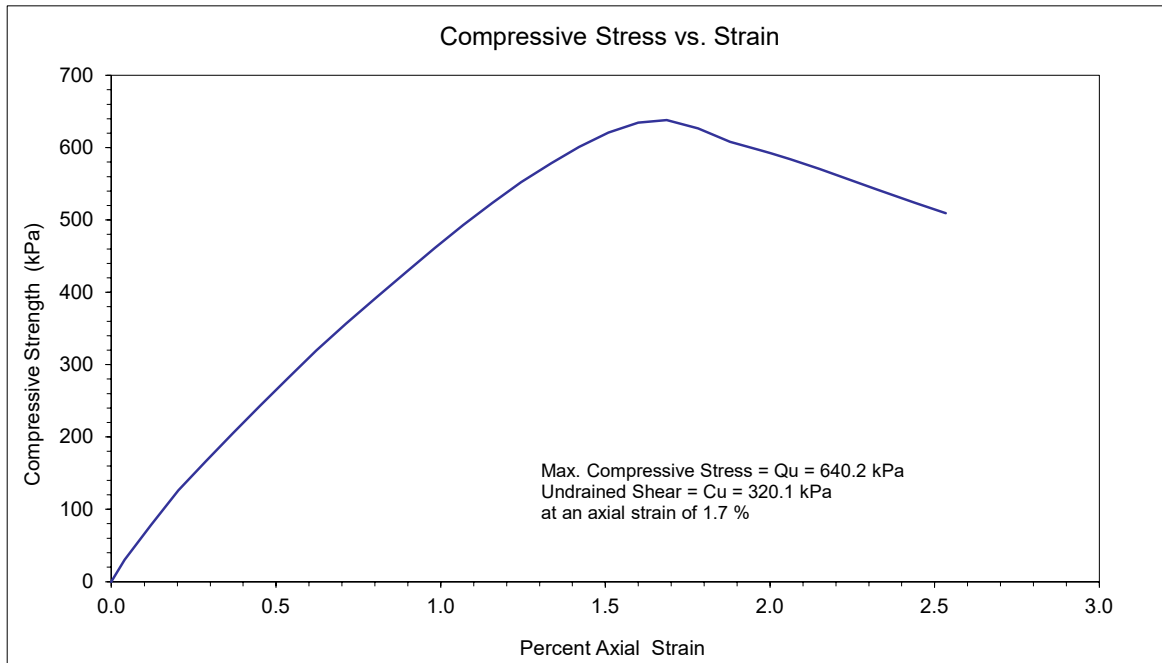
TEST DATE: Oct 27/20
SAMPLE: TH20-1 @ 48.40 - 48.56 m
DESCRIPTION: Bentonitic Clay Shale (CH), silty, trace coal stringers, greenish grey.

SPECIMEN DETAILS:

Wet Density (kg/m³): 2148
Dry Density (kg/m³): 1863
Moisture Content (%): 15.3

Liquid Limit (%): -
Plastic Limit (%): -
Plasticity Index (%): -

Gravel (%): -
Sand (%): -
Silt (%): -
Clay (%): -



THURBER ENGINEERING LTD. UNCONFINED COMPRESSION TEST REPORT

AEAL
FILE NUMBER : 28874

REPORT DATE: Oct 29/20
REPORT NUMBER: UC20-8

Wellington Bridge

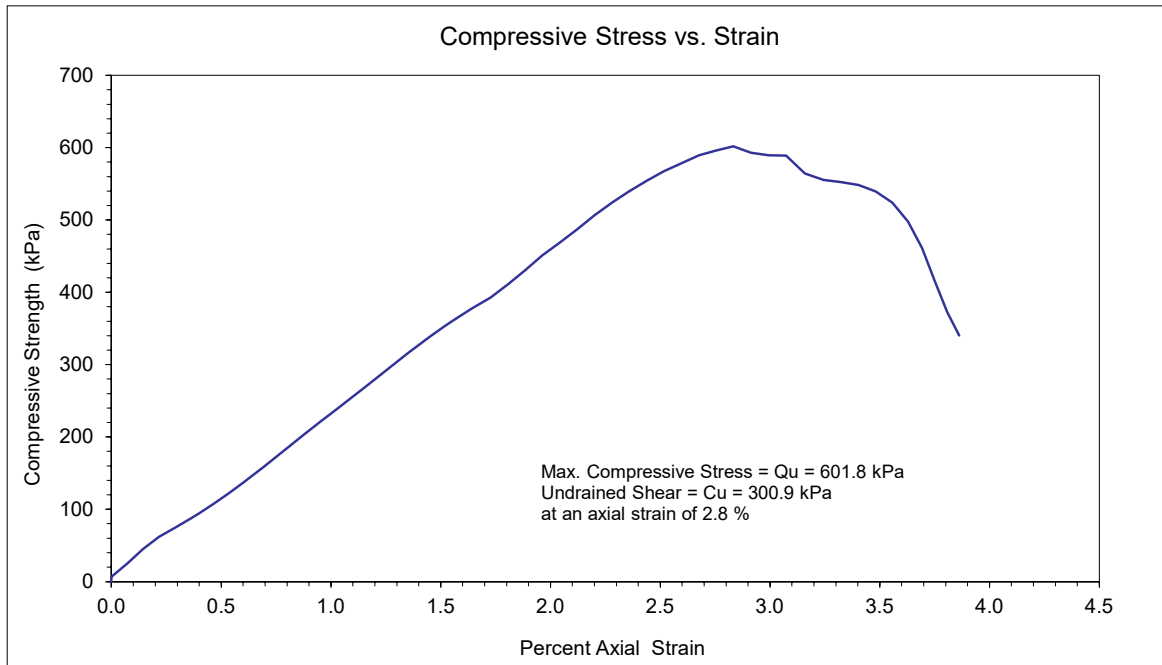
TEST DATE: Oct 27/20
SAMPLE: TH20-1 @ 51.97 - 52.10 m
DESCRIPTION: Clay Shale (CH), silty, trace silt lenses, coal stringers, grey.

SPECIMEN DETAILS:

Wet Density (kg/m³): 2199
Dry Density (kg/m³): 1951
Moisture Content (%): 12.7

Liquid Limit (%): -
Plastic Limit (%): -
Plasticity Index (%): -

Gravel (%): -
Sand (%): -
Silt (%): -
Clay (%): -



THURBER ENGINEERING LTD. UNCONFINED COMPRESSION TEST REPORT

AEAL
FILE NUMBER : 28874

REPORT DATE: Oct 29/20
REPORT NUMBER: UC20-9

Wellington Bridge

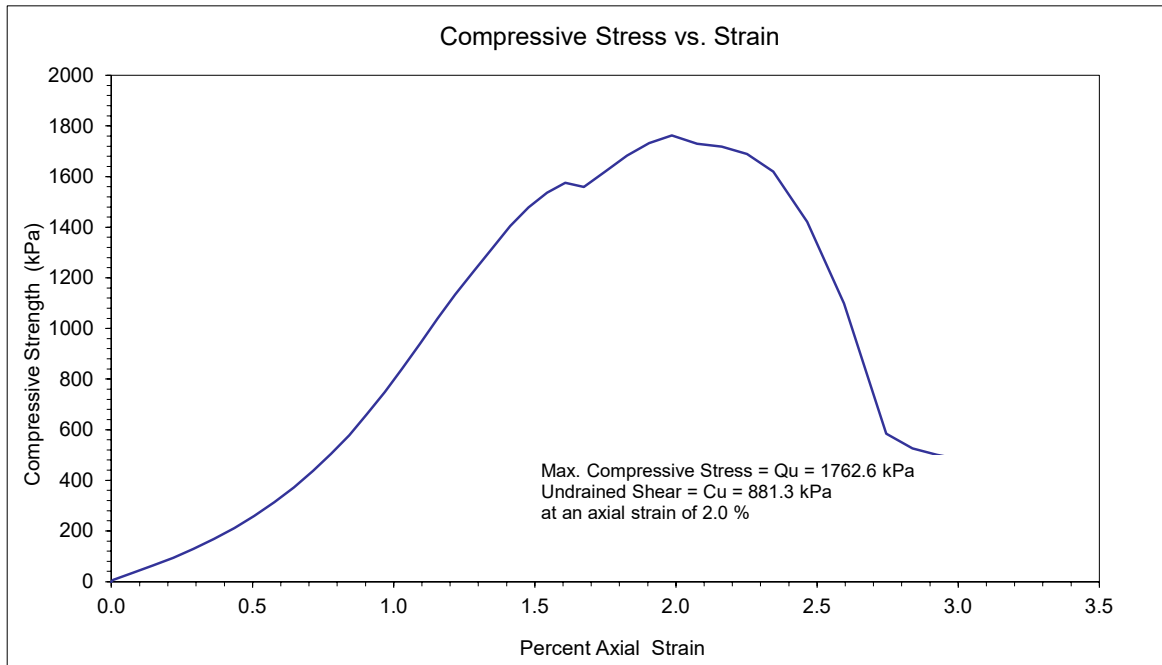
TEST DATE: Oct 27/20
SAMPLE: TH20-2 @ 55.18 - 55.30 m
DESCRIPTION: Bentonic Clay Shale (CH), silty, trace coal stringers, bluish grey.

SPECIMEN DETAILS:

Wet Density (kg/m³): 2202
Dry Density (kg/m³): 1909
Moisture Content (%): 15.3

Liquid Limit (%): -
Plastic Limit (%): -
Plasticity Index (%): -

Gravel (%): -
Sand (%): -
Silt (%): -
Clay (%): -



THURBER ENGINEERING LTD. UNCONFINED COMPRESSION TEST REPORT

AEAL
FILE NUMBER : 28874

REPORT DATE: Oct 29/20
REPORT NUMBER: UC20-10

Wellington Bridge

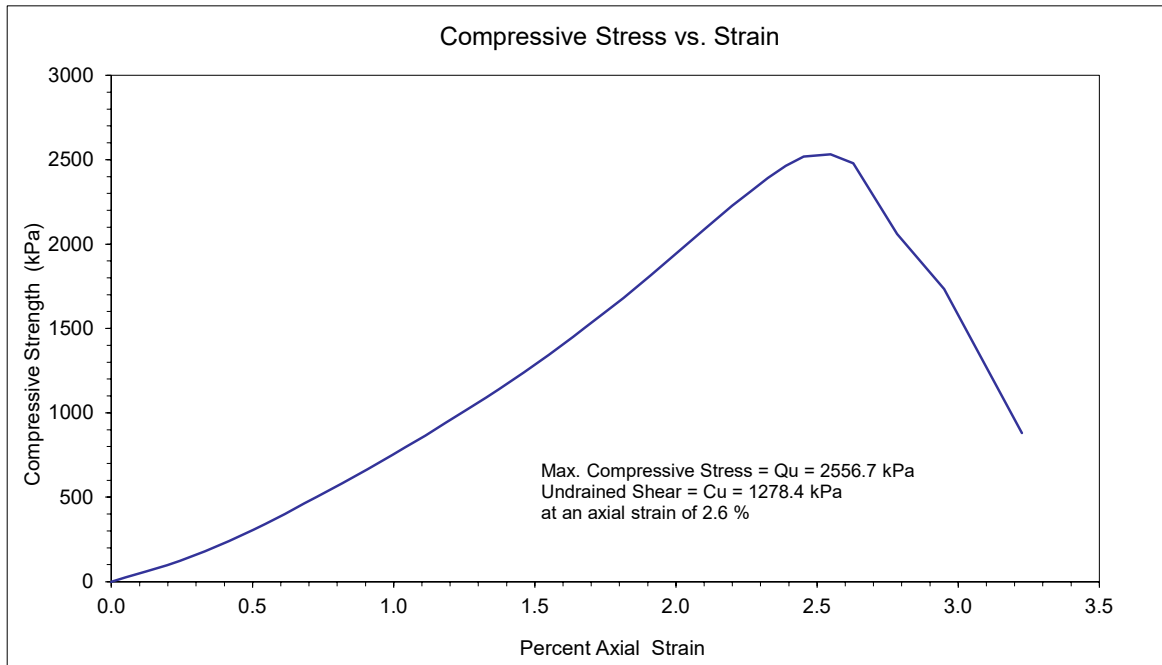
TEST DATE: Oct 27/20
SAMPLE: TH20-2 @ 58.22 - 58.35 m
DESCRIPTION: Sandstone (SC), fine to medium grain, bentonitic, silty, coal, light grey.

SPECIMEN DETAILS:

Wet Density (kg/m³): 2207
Dry Density (kg/m³): 1942
Moisture Content (%): 13.7

Liquid Limit (%): -
Plastic Limit (%): -
Plasticity Index (%): -

Gravel (%): -
Sand (%): -
Silt (%): -
Clay (%): -





THURBER ENGINEERING LTD.

February 6, 2014

File: 17-834-167

CH2M HILL
Suite 800, Highfield Place
10010 – 106 Street
Edmonton, Alberta
T5J 3L8

Attention: Ms. Malika Ali, P.Eng.

**WELLINGTON BRIDGE REHABILITATION
EDMONTON, ALBERTA
GEOTECHNICAL INVESTIGATION**

Dear Ms. Ali,

This letter presents the results of a geotechnical investigation completed by Thurber Engineering Ltd. (Thurber) to provide geotechnical input with respect to the bearing capacity of existing and proposed foundation elements supporting the superstructure of the above-noted bridge. The bridge is located on 102 Avenue east of 132 Street in Edmonton, Alberta.

Thurber previously completed a desktop study for this project and provided an assessment of the bearing capacity of the existing foundations of the bridge in a letter dated September 18, 2013.

It was determined by the City of Edmonton (City) that a geotechnical investigation was required to obtain site specific geotechnical information at the bridge site in order to provide more reliable geotechnical recommendations for the foundations.

The work presented in this letter was undertaken in in general accordance with the scope change letter prepared by Thurber, dated December 10, 2013. Notice to proceed with the assessment was given by Ms. Malika Ali, P.Eng. of CH2M HILL in December 2013.

1. PROJECT DETAILS

The Wellington Bridge is one of the oldest bridges in the City of Edmonton (City) and is a “designated municipal historical resource.”

According to the available information, it is understood that the Wellington Bridge was constructed in 1932 and is a three span, 47 m long concrete arch structure that spans over Ramsey Ravine. Existing as-built foundation drawings indicate that the bridge abutments and piers are supported on four concrete footings which are approximately 2.5 m deep, 3.7 to 5.2 m wide and 4.4 to 5.5 m long. The drawings also indicate that the pier footings are inclined to horizontal and are supported on 1.5 to 2.4 m deep, 300 mm diameter timber piles.

It is understood that a preliminary assessment completed by CH2M Hill indicated that the Wellington Bridge is structurally deficient to carry truck loads during the construction of the



102nd Avenue bridge replacement over Groat Road and therefore the City has decided to strengthen the Wellington Bridge using a temporary shoring system on both sides of the bridge. The shoring towers will be installed at 6 m intervals for a total of 32 towers. It is currently understood that the towers will be supported on either one metre by one metre square spread footings or a group of helical steel (screw) piles.

2. SCOPE OF WORK

Our original scope of work included the following tasks:

1. Drilling test holes
2. Laboratory testing
3. Preparation of a letter to summarize the geotechnical investigation findings and provide revised bearing capacity values for the existing bridge footings and the proposed showing tower footings

3. METHOD OF INVESTIGATION

3.1 Field Program

Two test holes (TH14-1 and TH14-2) as shown on Drawing No. 17-834-167-1, attached were drilled adjacent to the existing bridge pier foundations within the Ramsey ravine on January 20, 2014. The test holes were drilled using a track-mounted auger drill rig. The test hole locations were accessed via the existing bike path that descends from Churchill Crescent. Both test holes were advanced to a depth of 10.4 m below existing ground surface.

4. SITE CONDITIONS

4.1 Subsurface Conditions

In general, the stratigraphy at the test hole locations typically consists of a surficial clay layer overlying clay till, underlain by sand, as shown on the attached test hole logs.

An approximately 200 mm thick gravel layer was encountered in TH14-1 at ground surface.

Clay was encountered below the gravel in TH14-1 and at ground surface in TH14-2. The clay extended to a depth of 1.2 m in TH14-1 and 0.9 m in TH14-2. The clay was typically low to medium plastic, brown and mixed with gravel, sand, silt and organic rootlets. The surficial clay was observed to be frozen to a depth of about 0.2 m below ground surface. SPT 'N' blow counts ranged from 9 to 14 blows per 300 mm penetration, indicating that the clay has a stiff consistency.

Clay till was encountered underlying the surficial clay layer, and extended to the maximum investigation depth in TH14-1 and to a depth of 9.1 m in TH14-2. The clay till was medium plastic, brown and contained traces of silt, oxides, sand, and siltstone. SPT 'N' blow counts



ranged from 11 to 29 blows per 300 mm penetration, indicating that the clay till has a stiff to very stiff consistency. The clay till was generally noted to very stiff below 4 m depth. Four Atterberg Limits tests were performed on selected clay till samples indicate a liquid limit ranging from 30 to 35 percent and a plastic limit ranging from 14 to 17 percent.

Although not encountered during drilling, cobbles and boulders are frequently encountered in clay till deposits.

Sand was encountered underlying the clay till in TH14-2 at a depth of 9.1 m, and extended to the maximum investigation depth of the test hole. The sand was loose to very dense, grey, and medium grained. A grain size analysis test of a selected sand sample showed a gravel content of about 1 percent, a sand content of 90 percent, and 9 percent fines (silt and clay passing the 80 µm sieve).

4.2 Groundwater Conditions

Sloughing and groundwater seepage were monitored in the test holes during and immediately after drilling. Standpipe piezometers were installed in both test holes. Groundwater levels were also measured after drilling completion, and again on February 4, 2014. The results are summarized in Table 4.1.

**TABLE 4.1
TEST HOLE GROUNDWATER CONDITIONS
SUMMARY OF SLOUGHING/SEEPAGE AND GROUNDWATER LEVELS**

TEST HOLE	TEST HOLE DEPTH B.G.S. (m)	SLOUGH LEVEL ON COMPLETION B.G.S. (m)	GROUND WATER AT COMPLETION B.G.S. (m)	STANDPIPE WATER LEVELS February 4, 2014 B.G.S. (m)
TH14-1	10.4	10.2	Dry	9.5
TH14-2	10.4	10.1	Dry	11.1

Note (1) BGS = Below Ground Surface.

It should be noted that groundwater levels can vary in response to seasonal climate factors and precipitation, hence, the actual groundwater levels in the standpipes may differ at the time of construction and could vary from those recorded during the course of this investigation.

It is recommended that the groundwater levels be recorded prior to construction to determine seasonal ground water fluctuations.



4.3 Frost Effects

The medium plastic clay and clay till layers, encountered in the test holes, are expected to have low to moderate frost susceptibility.

The expected depth of frost penetration has been estimated for the average soil properties for the in-situ materials encountered in the test holes for both the mean annual Air Freezing Index (AFI) and the 50 year return period Air Freezing Index of 1440°C and 2220°C days, respectively. Where the clay is continuous from ground surface, the average annual depth of frost penetration is estimated to be about 1.6 m, and the penetration for a 50-year return period is about 2.4 m.

The estimated depth of frost penetration is for a uniform soil type with no insulation cover. The depth of frost penetration will be reduced if turf or snow cover is present.

5. GEOTECHNICAL ASSESSMENT AND RECOMMENDATIONS

5.1 General

In general, the soil conditions at the test hole locations consist of 4 m of stiff clay and clay till underlain by very stiff clay till extending to 9 m depth and sand below that depth. Short-term groundwater levels are about 9.5 m below existing ground surface at the test hole locations.

The assessment and recommendations provided in the following sections are based on the following assumptions:

- 1- The soil conditions are generally similar at the other temporary pier and abutment locations.
- 2- The existing bridge footings are founded on the clay till, as per the as-built drawings. Since the site and test holes were not surveyed, it was not possible to confirm if the footings are founded on the clay till formation.

5.2 Existing Bridge Foundations

Based on the information gathered from the field and laboratory investigations, it is assumed that the bridge footings are founded on the stiff to very stiff clay till stratum. For this type of material, and as-built dimensions of bridge footings, the estimated ultimate bearing capacity is 650 kPa is expected, which is consistent with the lower bound value of our previous recommendations. The factored ULS bearing resistance is 325 kPa based on a geotechnical resistance factor of 0.5.

The above noted bearing capacity values are for footings subject to concentric loads. For footings subjected to eccentric loads, a reduction is required to the effective bearing area of the footings, when calculating the footing ULS capacity, as follows:



$$B' = B - 2e_B$$

$$L' = L - 2e_L$$

Where:

B' , L' , are the effective footing dimensions

e_B , e_L , are the eccentricities in the B and L;

B, L, are the actual footing dimensions

The same ULS bearing capacity given above may be used with the effective footing dimension in calculating the factored ULS footing load.

5.3 Proposed Shoring Tower Foundations

5.3.1 General

As per our discussions with CH2M Hill, it is understood that the proposed shoring towers will be supported on spread footings, situated either at about 0.5 m below existing ground surface (i.e. above the frost depth) or below the frost level. It is also understood that the footings will only be subject to concentric loads. The effects on the existing bridge footings will need to be taken into account as indicated in the following sections.

Helical steel (screw) piles are also considered feasible to support the shoring towers. Recommendations are provided in Section 5.3.4. These may have the advantage of causing less construction disturbance and less impact on the existing bridge footings.

The following sections provide general discussions and recommendations for these foundation alternatives. More detailed recommendations for the design and construction of the selected foundation type may be provided at a future date when more details on the foundation design are available.

5.3.2 Shallow Spread Footings

It is understood that shallow spread footings founded within 0.5 m of the ground surface are being considered for the foundations of the shoring towers. It should be noted that shallow foundations may be subject to frost heave effects unless the footings are insulated. In addition, the shallow foundations are expected to be founded in the clay layer above the clay till and the resulting bearing capacities will be lower than footings extending into the underlying clay till.

Based on the information gathered from the field and laboratory investigations shallow spread footing are expected to be founded on the native stiff clay stratum above the clay till. An ultimate bearing capacity value of 360 kPa may be used for the design of the footings supported on the native stiff clay. The factored ULS bearing resistance is 175 kPa based on a geotechnical resistance factor of 0.5.



It is noted that the groundwater table is relatively deep at this site and the near surface soils are considered low to moderately frost susceptible. Uninsulated footings may therefore be subjected to seasonal movements, possibly in the order of 30 mm, assuming that dead loading is maintained as high as practical on the footings to resist frost heaving. In addition, it may be feasible to adjust the shoring towers to correct for frost heave.

If this amount of frost heaving is not desirable, then the footings should be insulated to mitigate the frost effects.

5.3.3 Deep Spread Footings

Based on the information gathered from the field and laboratory investigations, spread footings founded below the frost depth (i.e. at 2.4 m or deeper) are expected to be founded in the stiff to very stiff clay till stratum. An ultimate bearing capacity value of 530 kPa may be used for the design of spread footings supported on the native stiff to very stiff clay till. The factored ULS bearing resistance for the footings would be 265 kPa based on a geotechnical resistance factor of 0.5.

If the spread footings are founded below the frost depth, this will eliminate the need for frost mitigation measures. However, the construction of foundation elements at this depth may require the use of vertically shored excavations to provide protection to the existing bridge foundations when excavations are in close proximity to the existing bridge footings. For preliminary purposes, shored excavations should be undertaken for excavations within 4 m from the edge of existing bridge footings.

Temporary open excavations (i.e. up to 2 weeks duration) at locations away from the bridge supports to construct shoring footings may be constructed at inclination of 1H:1.5V through stiff clay and clay till. In areas where wet sand, loose and/or softer layers are encountered, flatter slopes tapered back from the base of the excavation at 1H:1V, or flatter may be considered.

Excavated spoil material should be kept back from the top of the footing trenches by at least the depth of the excavation and should not be placed on a sloping ground where it may cause slope instability. Personnel should not be allowed in the open footing excavations without proper safety precautions being taken. The above recommendations are provided for design and planning purposes and are not a clearance for Alberta Occupational Health and Safety. In all cases, excavations should be consistent with the most recent Occupational Health and Safety Regulations and Code, which should be followed by the prime contractors.

Water-bearing sand and silt layers may be present within the clay/clay till layers. Where encountered, the seepage is expected to be of magnitude that can be handled by normal trench grading and use of sump and pump drainage where required.

Excavated clay and clay till are deemed suitable for backfilling footing trenches. Moisture conditioning of excavated soils may be required to meet compaction requirements. All backfill material should be compacted to at least 98 percent of SPMDD within +/- 2 percent of OMC.



5.3.4 Helical Steel (Screw) Piles

Helical steel (screw) piles may also be used to support the shoring towers. They are generally not recommended for support of dynamic loading, or foundations subjected to large lateral loads. A contractor experienced with the installation of screw piles should be contacted to check site accessibility and confirm if there is enough room under the bridge to accommodate the installation equipment.

Helical piles typically consist of a steel pipe shaft with one or more helices welded onto the shaft. The piles are rotated into the ground with a hydraulic drive to adequate depth to achieve the required resistance.

Helical piles can typically be installed into stiff to very stiff clay till, as encountered at this site. The depth of penetration and required design of helices (single or multiple) will depend on the soil conditions and design vertical and lateral loads. Helical piles have difficulties in penetrating into cobbly gravels, clay till with boulders, or hard clay till and may meet premature refusal if these conditions are encountered. Helical piles should be founded with the helices in native clay till below the depth of any fill and also below the depth of frost.

Shaft diameters typically vary from about 200 to 400 mm for moderately loaded piles. Pile helix diameters typically vary from 300 to 800 mm diameter. Helical piles need to be designed by a structural engineer to meet the required installation stresses and also the expected geotechnical conditions.

The capacity of helical piles can be determined using the bearing capacity theory. The major factors that affect the vertical capacity are the pile geometry (diameter, depth and spacing of helices), soil and ground water profile and the installation procedures.

The ultimate capacity of the helical pile (Q_{ult}) with a single helix in clay till may be expressed as follows:

$$Q_{ult} = (9 \times C_u + \gamma' H) \times (\pi \times D^2 / 4) \text{ (kN)}$$

Where

C_u = Undrained shear strength at the depth of the helix plate (kPa)

γ' = Effective unit weight (use 21 kN/m³ above water table and 11 kN/m³ below water table)

H = Helix embedment (m)

D = Helix plate diameter (m)

For preliminary design, an average undrained shear strength value of 100 kPa may be used to design the screw piles, assuming that the upper helix is situated in the very stiff clay till at least 3 m below existing ground surface.



A geotechnical resistance factor of 0.4 in compression and 0.3 in tension should be used to determine the factored ULS geotechnical capacity, in accordance with the NBC 2005.

Shaft friction should generally be ignored for preliminary design for small diameter shafts due to potential effects of disturbance and loss of shaft adhesion.

The above noted calculation should be completed for each helix in the case of multiple helices. A reduction factor should be applied to the calculated capacity if the vertical spacing between the helices is less than 5 times the average diameter of the helices as presented in Table 5.1.

**TABLE 5.1
RECOMMENDED INTERACTION FACTORS FOR HELICAL PILE DESIGN**

RATIO OF AVERAGE HELIX SPACING TO AVERAGE HELIX DIAMETER (S/D)	INTERACTION FACTOR
2.5	0.65
3	0.75
3.5	0.85
4	0.95
5	1.0

It should be recognized that helical pile capacities are highly dependent on the pile design geometry and method of installation, and the screw pile designs are typically completed and warranted by the Piling Contractor. Depending on the number of screw piles, it may be beneficial to undertake pile load tests on representative piles at the site to verify the load carrying capacity of helical piles. Where load tests are performed, the geotechnical resistance factors may be increased accordingly.

It is recommended that the final helical pile design be reviewed by a geotechnical engineer. In addition, the structural capacity may be checked for the applied loading conditions.

Helical piles should be checked for frost uplift. An ultimate frost heave of 80 kPa should be used for a bare steel shaft within the depth of frost penetration. A resistance factor of 0.3 (in tension) may be applied to the ultimate helix capacity in resisting frost heave forces calculated by the above methods. The upper part of the shaft may be double wrapped with yellow jacket tape to reduce the frost adhesion bond and eliminate the frost heave concern.

Helical piles should not be installed at spacing closer than three times the largest helix diameter, center to center. The upper helix should be located below the frost penetration depth. The screw piles installations should be monitored to determine that the advancement rate of the screw piles is appropriate.



5.4 Cement Type

Four tests were selected to determine the water-soluble sulphate ion (SO_4) content of soil samples from the test holes drilled along the alignment in the event that concrete based structures are included as part of the project. The results are summarized in Table 5.2.

**TABLE 5.2
SOLUBLE SULPHATE CONTENT**

TEST HOLE	SOLUBLE SULPHATE CONTENT in PERCENT (PFRA Method)
TH14-1 @ 1.5 m	0.02
TH14-1 @ 3.7 m	0.04
TH14-2 @ 0.3 m	0.04
TH14-2 @ 3.3 m	0.08

These tests indicated the presence of 0.02 to 0.08 percent water-soluble sulphate content in the soil samples indicating that there is no potential for sulphate attack on the subsurface concrete. As a result, CSA Type GU (General Use hydraulic cement, old CSA Type 10) may be used in the subsurface concrete at this project site.

The recommendations stated above for the subsurface concrete at this site may require further additions and / or modifications due to structural, durability, service life or other considerations which are beyond the geotechnical scope.

In addition, if imported material is required to be used at the site and will be in contact with concrete, it is recommended that the fill soil be tested for sulphate content to determine whether the above-stated recommendations remain valid.



6. CLOSURE

We trust this information meets with your needs at this time. Please contact the undersigned should questions arise.

The work conducted by Thurber is subject to the Statement of Limitations and Conditions that is included at the end of the text of this report.

Yours very truly,
Thurber Engineering Ltd.
Tarek Abdelaziz, Ph.D., P.Eng.
Review Engineer

Stephen Coulter, P.Eng., P.E.
Project Engineer
/meg

Attachments

- Statement of Limitations and Conditions
- Drawing No. 17-834-167-1
- Terms and Symbols Used on Test Hole Logs
- Modified Unified Soil Classification System for Soils
- Test Hole Logs



STATEMENT OF LIMITATIONS AND CONDITIONS

1. STANDARD OF CARE

This study and Report have been prepared in accordance with generally accepted engineering or environmental consulting practices in this area. No other warranty, expressed or implied, is made.

2. COMPLETE REPORT

All documents, records, data and files, whether electronic or otherwise, generated as part of this assignment are a part of the Report which is of a summary nature and is not intended to stand alone without reference to the instructions given to us by the Client, communications between us and the Client, and to any other reports, writings, proposals or documents prepared by us for the Client relative to the specific site described herein, all of which constitute the Report.

IN ORDER TO PROPERLY UNDERSTAND THE SUGGESTIONS, RECOMMENDATIONS AND OPINIONS EXPRESSED HEREIN, REFERENCE MUST BE MADE TO THE WHOLE OF THE REPORT. WE CANNOT BE RESPONSIBLE FOR USE BY ANY PARTY OF PORTIONS OF THE REPORT WITHOUT REFERENCE TO THE WHOLE REPORT.

3. BASIS OF REPORT

The Report has been prepared for the specific site, development, design objectives and purposes that were described to us by the Client. The applicability and reliability of any of the findings, recommendations, suggestions, or opinions expressed in the document, subject to the limitations provided herein, are only valid to the extent that this Report expressly addresses proposed development, design objectives and purposes, and then only to the extent there has been no material alteration to or variation from any of the said descriptions provided to us unless we are specifically requested by the Client to review and revise the Report in light of such alteration or variation or to consider such representations, information and instructions.

4. USE OF THE REPORT

The information and opinions expressed in the Report, or any document forming part of the Report, are for the sole benefit of the Client. NO OTHER PARTY MAY USE OR RELY UPON THE REPORT OR ANY PORTION THEREOF WITHOUT OUR WRITTEN CONSENT AND SUCH USE SHALL BE ON SUCH TERMS AND CONDITIONS AS WE MAY EXPRESSLY APPROVE. The contents of the Report remain our copyright property. The Client may not give, lend or, sell the Report, or otherwise make the Report, or any portion thereof, available to any person without our prior written permission. Any use which a third party makes of the Report, are the sole responsibility of such third parties. Unless expressly permitted by us, no person other than the Client is entitled to rely on this Report. We accept no responsibility whatsoever for damages suffered by any third party resulting from use of the Report without our express written permission.

5. INTERPRETATION OF THE REPORT

- a) Nature and Exactness of Soil and Contaminant Description: Classification and identification of soils, rocks, geological units, contaminant materials and quantities have been based on investigations performed in accordance with the standards set out in Paragraph 1. Classification and identification of these factors are judgmental in nature. Comprehensive sampling and testing programs implemented with the appropriate equipment by experienced personnel, may fail to locate some conditions. All investigations utilizing the standards of Paragraph 1 will involve an inherent risk that some conditions will not be detected and all documents or records summarizing such investigations will be based on assumptions of what exists between the actual points sampled. Actual conditions may vary significantly between the points investigated and the Client and all other persons making use of such documents or records with our express written consent should be aware of this risk and this report is delivered on the express condition that such risk is accepted by the Client and such other persons. Some conditions are subject to change over time and those making use of the Report should be aware of this possibility and understand that the Report only presents the conditions at the sampled points at the time of sampling. Where special concerns exist, or the Client has special considerations or requirements, the Client should disclose them so that additional or special investigations may be undertaken which would not otherwise be within the scope of investigations made for the purposes of the Report.
- b) Reliance on Provided Information: The evaluation and conclusions contained in the Report have been prepared on the basis of conditions in evidence at the time of site inspections and on the basis of information provided to us. We have relied in good faith upon representations, information and instructions provided by the Client and others concerning the site. Accordingly, we cannot accept responsibility for any deficiency, misstatement or inaccuracy contained in the Report as a result of misstatements, omissions, misrepresentations, or fraudulent acts of the Client or other persons providing information relied on by us. We are entitled to rely on such representations, information and instructions and are not required to carry out investigations to determine the truth or accuracy of such representations, information and instructions.

(see over ...)



INTERPRETATION OF THE REPORT *(continued. . .)*

- c) Design Services: The Report may form part of the design and construction documents for information purposes even though it may have been issued prior to the final design being completed. We should be retained to review the final design, project plans and documents prior to construction to confirm that they are consistent with the intent of the Report. Any differences that may exist between the report recommendations and the final design detailed in the contract documents should be reported to us immediately so that we can address potential conflicts.
- d) Construction Services: During construction we must be retained to provide field reviews. Field reviews consist of performing sufficient and timely observations of encountered conditions to confirm and document that the site conditions do not materially differ from those interpreted conditions considered in the preparation of the report. Adequate field reviews are necessary for Thurber to provide letters of assurance, in accordance with the requirements of many regulatory authorities.

6. RISK LIMITATION

Geotechnical engineering and environmental consulting projects often have the potential to encounter pollutants or hazardous substances and the potential to cause an accidental release of those substances. In consideration of the provision of the services by us, which are for the Client's benefit, the Client agrees to hold harmless and to indemnify and defend us and our directors, officers, servants, agents, employees, workmen and contractors (hereinafter referred to as the "Company") from and against any and all claims, losses, damages, demands, disputes, liability and legal investigative costs of defence, whether for personal injury including death, or any other loss whatsoever, regardless of any action or omission on the part of the Company, that result from an accidental release of pollutants or hazardous substances occurring as a result of carrying out this Project. This indemnification shall extend to all Claims brought or threatened against the Company under any federal or provincial statute as a result of conducting work on this Project. In addition to the above indemnification, the Client further agrees not to bring any claims against the Company in connection with any of the aforementioned causes.

7. SERVICES OF SUBCONSULTANTS AND CONTRACTORS

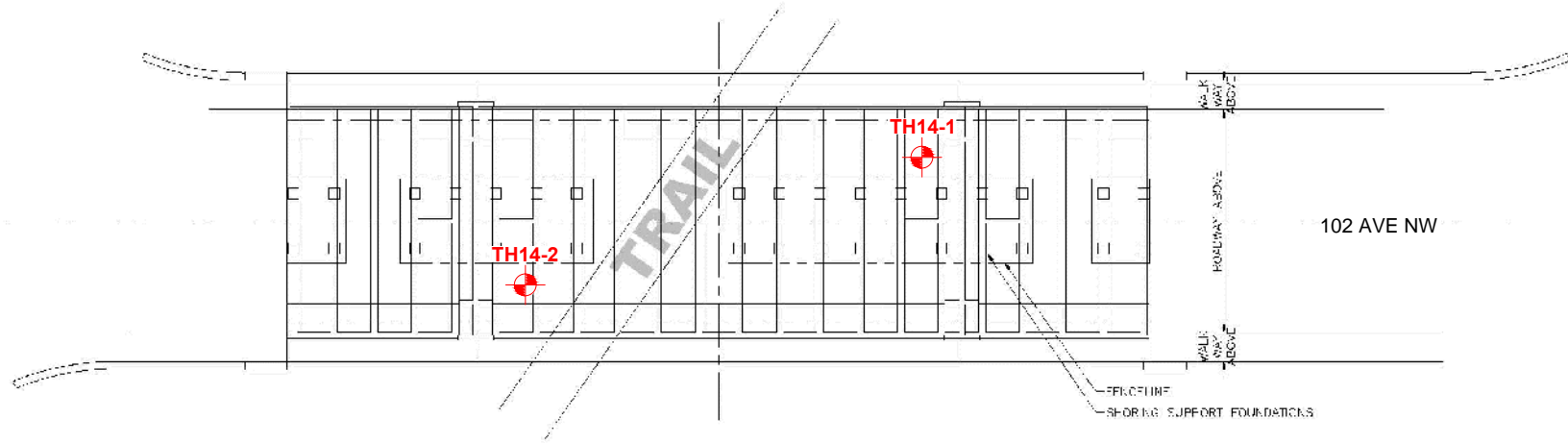
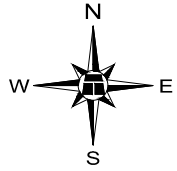
The conduct of engineering and environmental studies frequently requires hiring the services of individuals and companies with special expertise and/or services which we do not provide. We may arrange the hiring of these services as a convenience to our Clients. As these services are for the Client's benefit, the Client agrees to hold the Company harmless and to indemnify and defend us from and against all claims arising through such hirings to the extent that the Client would incur had he hired those services directly. This includes responsibility for payment for services rendered and pursuit of damages for errors, omissions or negligence by those parties in carrying out their work. In particular, these conditions apply to the use of drilling, excavation and laboratory testing services.

8. CONTROL OF WORK AND JOBSITE SAFETY

We are responsible only for the activities of our employees on the jobsite. The presence of our personnel on the site shall not be construed in any way to relieve the Client or any contractors on site from their responsibilities for site safety. The Client acknowledges that he, his representatives, contractors or others retain control of the site and that we never occupy a position of control of the site. The Client undertakes to inform us of all hazardous conditions, or other relevant conditions of which the Client is aware. The Client also recognizes that our activities may uncover previously unknown hazardous conditions or materials and that such a discovery may result in the necessity to undertake emergency procedures to protect our employees as well as the public at large and the environment in general. These procedures may well involve additional costs outside of any budgets previously agreed to. The Client agrees to pay us for any expenses incurred as the result of such discoveries and to compensate us through payment of additional fees and expenses for time spent by us to deal with the consequences of such discoveries. The Client also acknowledges that in some cases the discovery of hazardous conditions and materials will require that certain regulatory bodies be informed and the Client agrees that notification to such bodies by us will not be a cause of action or dispute.

9. INDEPENDENT JUDGEMENTS OF CLIENT

The information, interpretations and conclusions in the Report are based on our interpretation of conditions revealed through limited investigation conducted within a defined scope of services. We cannot accept responsibility for independent conclusions, interpretations, interpolations and/or decisions of the Client, or others who may come into possession of the Report, or any part thereof, which may be based on information contained in the Report. This restriction of liability includes but is not limited to decisions made to develop, purchase or sell land.



LEGEND

 APPROXIMATE TEST HOLE LOCATION



BASE PLAN PROVIDED BY CH2MHILL



**WELLINGTON BRIDGE FOUNDATION
ASSESSMENT**
**SITE PLAN SHOWING APPROXIMATE
TEST HOLE LOCATIONS**

DWG No. 17-834-167-1

DRAWN BY	KLW
DESIGNED BY	SEC
APPROVED BY	TSA
SCALE	APPROX. 1:400
DATE	FEBRUARY 2014
FILE No.	17-834-167



SYMBOLS AND TERMS USED ON TEST HOLE LOGS

1. VISUAL TEXTURAL CLASSIFICATION OF MINERAL SOILS

<u>CLASSIFICATION</u>	<u>APPARENT PARTICLE SIZE</u>	<u>VISUAL IDENTIFICATION</u>
Boulders	Greater than 200 mm	Greater than 200 mm
Cobbles	75 mm to 200 mm	75 mm to 200 mm
Gravel	4.75 mm to 75 mm	5 mm to 75 mm
Sand	0.075 mm to 4.75 mm	Visible particles to 5 mm
Silt	0.002 mm to 0.075 mm	Non-Plastic particles, not visible to the naked eye
Clay	Less than 0.002 mm	Plastic particles, not visible to the naked eye

2. TERMS DESCRIBING CONSISTENCY (COHESIVE SOILS ONLY)

<u>DESCRIPTIVE TERM</u>	<u>APPROXIMATE UNDRAINED SHEAR STRENGTH</u>	<u>APPROXIMATE SPT * 'N' VALUE</u>
Very Soft	Less than 10 kPa	Less than 2
Soft	10 - 25 kPa	2 to 4
Firm	25 - 50 kPa	4 to 8
Stiff	50 - 100 kPa	8 to 15
Very Stiff	100 - 200 kPa	15 to 30
Hard	200 - 300 kPa	Greater than 30
Very Hard	Greater than 300 kPa	

} Modified from
} National Building
} Code

* SPT 'N' Value Standard Penetration Test 'N' Value - refers to the number of blows from a 63.5 kg hammer free falling a height of 0.76m to advance a standard 50mm outside diameter split spoon sampler for 0.3m depth into the undrilled portion of the test hole.

3. TERMS DESCRIBING DENSITY (COHESIONLESS SOILS ONLY)

<u>DESCRIPTIVE TERM</u>	<u>STANDARD PENETRATION TEST (SPT)</u> (Number of Blows per 300 mm)
Very Loose	0 - 4
Loose	4 - 10
Compact	10 - 30
Dense	30 - 50
Very Dense	Over 50

} Modified from
} National Building
} Code

4. LEGEND FOR TEST HOLE LOGS

SYMBOL FOR SAMPLE TYPE

	Shelby Tube		A-Casing
	SPT		Grab
	No Recovery		Core

SYMBOLS USED FOR TEST HOLE LOGS

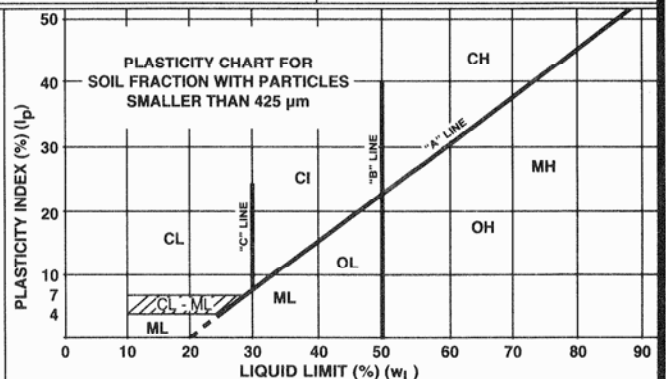
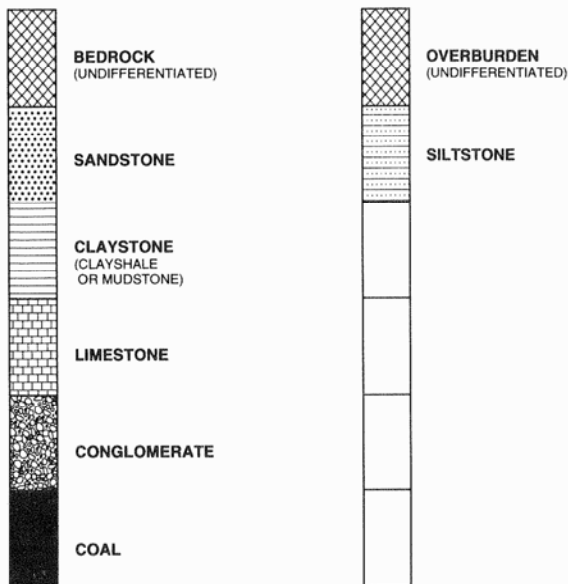
●	MC - Moisture Content (% by weight) of soil sample
▼	Water Level
■	SPT Standard Penetration Test 'N' Value (Blows/300mm)
▲	CPen Shear Strength determined by pocket penetrometer
CVane	Shear Strength determined by pocket vane
Cu	Undrained Shear Strength determined by unconfined compression test
SO ₄ %	Percent (%) of water soluble sulphate ions

MODIFIED UNIFIED CLASSIFICATION SYSTEM FOR SOILS

(MODIFIED BY PFRA, 1985)

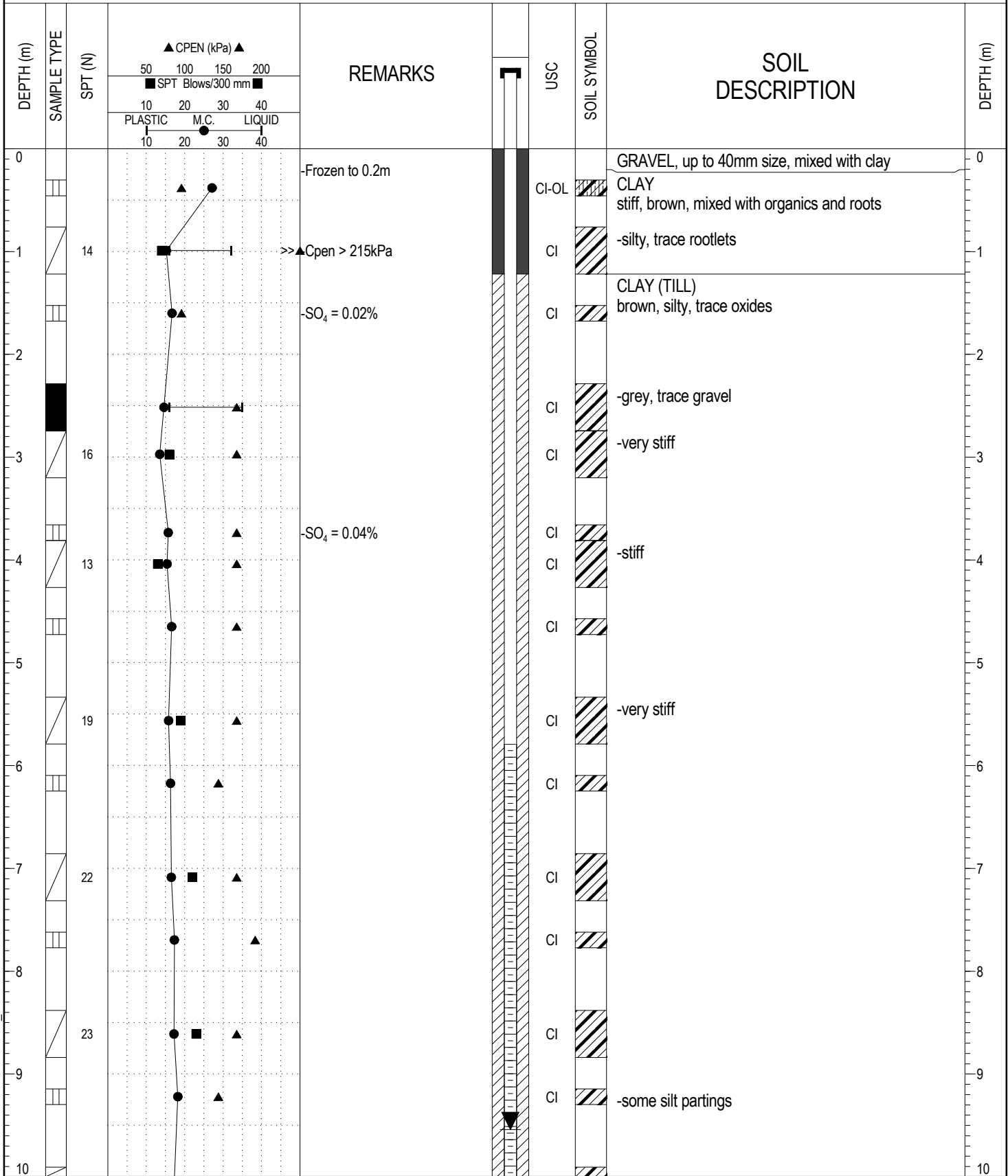
MAJOR DIVISION		GROUP SYMBOL	THURBER LOG SYMBOL	TYPICAL DESCRIPTION	LABORATORY CLASSIFICATION CRITERIA	
COARSE-GRAINED SOILS (MORE THAN HALF BY WEIGHT LARGER THAN 75µm)	GRAVELS MORE THAN HALF COARSE GRAINS LARGER THAN 4.75 mm	GW	Δ Δ Δ Δ	WELL GRADED GRAVELS, GRAVEL - SAND MIXTURES, LITTLE OR NO FINES	Determine percentages of gravel and sand from grain size curve. Depending on percentages of fines (fraction smaller than 75µm) coarse grained soils are classified as follows: Less than 5% GW, GP, SW, SP More than 5% to 12% GM, GC, SM, SC Borderline cases requiring use of dual symbols	
		GP	▲ ▲ ▲ ▲	POORLY GRADED GRAVELS, GRAVEL-SAND MIXTURES, LITTLE OR NO FINES		
		GRAVELS WITH FINES (APPRECIABLE AMOUNT OF FINES)	GM	▲ ▲ ▲ ▲		SILTY GRAVELS, GRAVEL-SAND-SILT MIXTURES
			GC	▲ ▲ ▲ ▲		CLAYEY GRAVELS, GRAVEL-SAND-CLAY MIXTURES
	SANDS MORE THAN HALF COARSE GRAINS SMALLER THAN 4.75 mm	SW	WELL GRADED SANDS, GRAVELLY SANDS, LITTLE OR NO FINES		
		SP	○ ○ ○ ○	POORLY GRADED SANDS, GRAVELLY SANDS, LITTLE OR NO FINES		
		SAND WITH FINES (APPRECIABLE AMOUNT OF FINES)	SM	○ ○ ○ ○		SILTY SANDS, SAND-SILT MIXTURES
			SC	○ ○ ○ ○		CLAYEY SANDS, SAND-CLAY MIXTURES
			GM	○ ○ ○ ○		GRAVELLY SANDS, SAND-SILT MIXTURES
		FINE-GRAINED SOILS (MORE THAN HALF BY WEIGHT SMALLER THAN 75µm)	SILTS BELOW "A" LINE NEGLIGIBLE ORGANIC CONTENT	$w_L < 50\%$		ML
$w_L > 50\%$	MH			INORGANIC SILTS, MICACEOUS OR DIATOMACEOUS, FINE SANDY OR SILTY SOILS		
CLAYS ABOVE "A" LINE NEGLIGIBLE ORGANIC CONTENT	$w_L < 30\%$		CL	INORGANIC CLAYS OF LOW PLASTICITY, GRAVELLY, SANDY, OR SILTY CLAYS, LEAN CLAYS		
	$30\% < w_L < 50\%$		CI	INORGANIC CLAYS OF MEDIUM PLASTICITY, GRAVELLY CLAYS, SANDY CLAYS, SILTY CLAYS		
	$w_L > 50\%$		CH	INORGANIC CLAYS OF HIGH PLASTICITY, FAT CLAYS		
ORGANIC SILTS & CLAYS BELOW "A" LINE	$w_L < 50\%$		OL	ORGANIC SILTS AND ORGANIC SILTY CLAYS OF LOW AND MEDIUM PLASTICITY		
	$w_L > 50\%$		OH	ORGANIC CLAYS OF HIGH PLASTICITY, ORGANIC SILTS		
HIGHLY ORGANIC SOILS			Pt	PEAT AND OTHER HIGHLY ORGANIC SOILS	STRONG COLOR OR ODOR, AND OFTEN FIBROUS TEXTURE	

SPECIAL SYMBOLS



MODIFIED UNIFIED CLASSIFICATION SYSTEM FOR SOILS
(MODIFIED BY PFRA, 1985)

CLIENT: CH2M HILL CANADA LTD	PROJECT: WELLINGTON BRIDGE ASSESSMENT	BOREHOLE NO: TH14-1
DRILLING COMPANY: Mobile Augers & Research Ltd.	DATE DRILLED: January 20, 2014	PROJECT NO: 17-834-167
DRILL/METHOD: M5 Track / Solid Stem Augers	LOCATION: See Drawing #17-834-167-1	ELEVATION:
SAMPLE TYPE	<input type="checkbox"/> GRAB SAMPLE <input checked="" type="checkbox"/> SPT <input checked="" type="checkbox"/> SHELBY TUBE	
BACKFILL TYPE	<input checked="" type="checkbox"/> BENTONITE <input checked="" type="checkbox"/> DRILL CUTTINGS <input type="checkbox"/> SLOUGH	



BOREHOLE LOG 17-834-167.GPJ, THRB, AB.GDT, 2/6/14- LIBRARY-NEW LOGO.GLB



FIELD LOGGED BY: YCL	COMPLETION DEPTH: 10.4 m
PREPARED BY: SEC	COMPLETION DATE: 1/20/14
REVIEWED BY: TSA	

CLIENT: CH2M HILL CANADA LTD	PROJECT: WELLINGTON BRIDGE ASSESSMENT	BOREHOLE NO: TH14-1
DRILLING COMPANY: Mobile Augers & Research Ltd.	DATE DRILLED: January 20, 2014	PROJECT NO: 17-834-167
DRILL/METHOD: M5 Track / Solid Stem Augers	LOCATION: See Drawing #17-834-167-1	ELEVATION:

SAMPLE TYPE	<input type="checkbox"/> GRAB SAMPLE	<input checked="" type="checkbox"/> SPT	<input type="checkbox"/> SHELBY TUBE
BACKFILL TYPE	<input checked="" type="checkbox"/> BENTONITE	<input checked="" type="checkbox"/> DRILL CUTTINGS	<input type="checkbox"/> SLOUGH

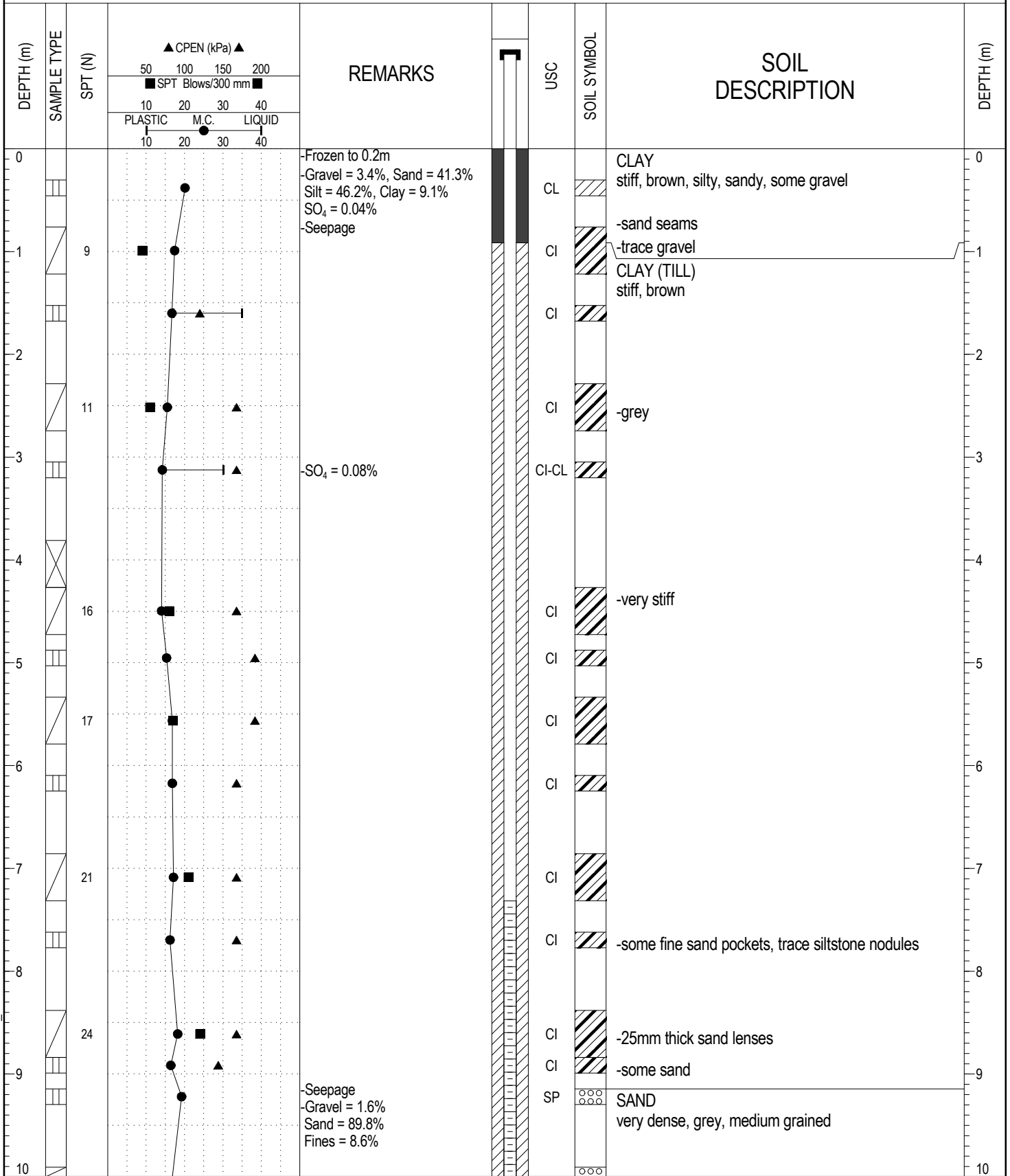
DEPTH (m)	SAMPLE TYPE	SPT (N)	CPEN (kPa) ▲			REMARKS	SLOTTED PIEZOMETER	USC	SOIL SYMBOL	SOIL DESCRIPTION	DEPTH (m)
			50	100	150						
10		29	10	20	30	40		CI	CLAY (TILL) - CONTINUED -trace coal	10	
11									END OF TEST HOLE AT 10.4m UPON COMPLETION: (Below ground surface) -Slough at 10.2m -No water Standpipe piezometer installed WATER LEVEL BELOW GROUND SURFACE: -January 20, 2014 = Dry -February 4, 2014 = 9.5m	11	
12										12	
13										13	
14										14	
15										15	
16										16	
17										17	
18										18	
19										19	
20										20	

BOREHOLE LOG 17-834-167.GPJ_THRRR_AB.GDT_2/6/14- LIBRARY-NEW LOGO.GLB



FIELD LOGGED BY: YCL	COMPLETION DEPTH: 10.4 m
PREPARED BY: SEC	COMPLETION DATE: 1/20/14
REVIEWED BY: TSA	

CLIENT: CH2M HILL CANADA LTD	PROJECT: WELLINGTON BRIDGE ASSESSMENT	BOREHOLE NO: TH14-2
DRILLING COMPANY: Mobile Augers & Research Ltd.	DATE DRILLED: January 20, 2014	PROJECT NO: 17-834-167
DRILL/METHOD: M5 Track / Solid Stem Augers	LOCATION: See Drawing #17-834-167-1	ELEVATION:
SAMPLE TYPE	<input type="checkbox"/> GRAB SAMPLE <input checked="" type="checkbox"/> SPT <input checked="" type="checkbox"/> NO RECOVERY	
BACKFILL TYPE	<input checked="" type="checkbox"/> BENTONITE <input type="checkbox"/> DRILL CUTTINGS <input type="checkbox"/> SLOUGH	



BOREHOLE LOG 17-834-167.GPJ, THURBER, AB.GDT, 2/6/14- LIBRARY-NEW LOGO.GLB



FIELD LOGGED BY: YCL	COMPLETION DEPTH: 11.9 m
PREPARED BY: SEC	COMPLETION DATE: 1/20/14
REVIEWED BY: TSA	

CLIENT: CH2M HILL CANADA LTD	PROJECT: WELLINGTON BRIDGE ASSESSMENT	BOREHOLE NO: TH14-2
DRILLING COMPANY: Mobile Augers & Research Ltd.	DATE DRILLED: January 20, 2014	PROJECT NO: 17-834-167
DRILL/METHOD: M5 Track / Solid Stem Augers	LOCATION: See Drawing #17-834-167-1	ELEVATION:

SAMPLE TYPE	<input type="checkbox"/> GRAB SAMPLE	<input checked="" type="checkbox"/> SPT	<input checked="" type="checkbox"/> NO RECOVERY
BACKFILL TYPE	<input checked="" type="checkbox"/> BENTONITE	<input checked="" type="checkbox"/> DRILL CUTTINGS	<input type="checkbox"/> SLOUGH

DEPTH (m)	SAMPLE TYPE	SPT (N)	REMARKS			SLOTTED PIEZOMETER	USC	SOIL SYMBOL	SOIL DESCRIPTION	DEPTH (m)
			CPEN (kPa)	SPT Blows/300 mm	PLASTIC					
10		50					SP	SAND - CONTINUED	10	
11							SP-SM		11	
12		9					SM	-loose	12	
12	END OF TEST HOLE AT 11.9m UPON COMPLETION: (Below ground surface) -Slough at 10.1m -Water at 8.8m Standpipe piezometer installed WATER LEVEL BELOW GROUND SURFACE: -January 20, 2014 = Dry -February 4, 2014 = 11.1m								12	
13									13	
14									14	
15									15	
16									16	
17									17	
18									18	
19									19	
20									20	

BOREHOLE LOG 17-834-167.GPJ_THRRR_AB.GDT_2/6/14- LIBRARY-NEW LOGO.GLB



FIELD LOGGED BY: YCL	COMPLETION DEPTH: 11.9m
PREPARED BY: SEC	COMPLETION DATE: 1/20/14
REVIEWED BY: TSA	

APPENDIX B - HISTORICAL RESOURCES APPROVAL

Historical Resources Act Approval with Conditions

Proponent: City of Edmonton
3rd Floor, City Hall, 1 Sir Winston Churchill Square, Edmonton, AB T5J 2R7

Contact: Cyril Balitbit

Agent: Circle CRM Group Inc.

Contact: Shannon Wright

Project Name: Wellington Bridge Replacement Project

Project Components: Bridge

Application Purpose: Requesting HRA Approval / Requirements

Historical Resources Act approval is granted for the activities described in this application and its attached plan(s)/sketch(es) subject to the following conditions.



David Link
Assistant Deputy Minister
Heritage Division
Alberta Culture, Multiculturalism
and Status of Women

SCHEDULE OF CONDITIONS

ARCHAEOLOGICAL RESOURCES

Historical Resources Act approval is granted in relation to archaeological resources, subject to the conditions outlined below.

1. *Historical Resources Act* approval relative to archaeological resources is granted conditionally on the understanding that the finalized development footprint is confined to the project polygon submitted with this application.

If the final project footprint extends outside of this polygon, the final development plans must be submitted for review by Alberta Culture, Multiculturalism and Status of Women. The final plans must be submitted in a new Historic Resources Application prior to the onset of development activities. The application must be accompanied by GIS shapefiles.

SCHEDULE OF CONDITIONS (continued)

PALAEONTOLOGICAL RESOURCES

There are no *Historical Resources Act* requirements associated with palaeontological resources; however, the proponent must comply with [Standard Requirements under the Historical Resources Act: Reporting the Discovery of Historic Resources](#), which are applicable to all land surface disturbance activities in the Province.

ABORIGINAL TRADITIONAL USE SITES

There are no *Historical Resources Act* requirements associated with Aboriginal traditional use sites of a historic resource nature; however, the proponent must comply with [Standard Requirements under the Historical Resources Act: Reporting the Discovery of Historic Resources](#), which are applicable to all land surface disturbance activities in the Province.

HISTORIC STRUCTURES

Historical Resources Act approval is granted relative to historic structures, subject to the conditions outlined below.

1. Documentation of historic structures is required prior to any development-related impact.

SITE	HRV	SITE DESCRIPTION	CONDITIONS/APPROVAL
Wellington Bridge	N/A	Bridge	Historic structure must be documented in accordance with the procedures and requirements outlined in the Requirements for Recording and Reporting Historic Structures .

PROVINCIALY DESIGNATED HISTORIC RESOURCES

There are no *Historical Resources Act* requirements associated with Provincially Designated Historic Resources; however, the proponent must comply with [Standard Requirements under the Historical Resources Act: Reporting the Discovery of Historic Resources](#), which are applicable to all land surface disturbance activities in the Province.

ADDITIONAL COMMENTS

1. In addition to any specific conditions detailed above, the proponent must abide by all [Standard Conditions under the Historical Resources Act](#).
2. To obtain contact information for consultants qualified to undertake the assessment work specified above, please consult the list of [Alberta Historic Resource Consultants](#).

Lands Affected: Additional Lands

Proposed Development Area:

MER	RGE	TWP	SEC	LSD List
4	25	53	1	1-2

SCHEDULE OF CONDITIONS (continued)

Documents Attached:

Document Name	Document Type
Project Plans	Illustrative Material



Heritage &
Archaeology
Consulting

August 13, 2021

Calgary Head Office

60, 4807 32 St. SE
Calgary, AB T2B 2X3
TEL: 403 984 8189
info@circleconsulting.ca
www.circleconsulting.ca

Edmonton Office

210, 10544 106 St. NW
Edmonton, AB T5H 2X6
TEL: 780 423 5840
info@circleconsulting.ca
www.circleconsulting.ca

Williams Lake Office

24, 605 Carson Drive
Williams Lake, BC V2G 1T1
TEL: 250 413 7092
info@circleconsulting.ca
www.circleconsulting.ca

Martina Purdon
Head, Regulatory Approvals & Information Management
Archaeological Survey
Historic Resources Management Branch
Alberta Culture, Multiculturalism and Status of Women
Old St. Stephen's College
8820 – 112 Street NW
Edmonton, Alberta T6G 2P8

Dear Martina:

**RE: Historic Resources Application (No. 019570663)
HRM Project (No. 4715-20-0061-001+002)
City of Edmonton
Wellington Bridge Replacement Project**

The City of Edmonton is seeking *Historical Resources Act* approval for the above captioned project.

The Proposed project will involve the replacement of the Wellington Bridge, which has fallen into disrepair in recent years. *Historic Resources Act* Approval with Conditions were issued for the Project on September 2, 2020, requiring documentation of the bridge prior to the onset of rehabilitation activities.

The bridge was recorded as HS 107522 on October 8, 2020, and any upgrades to the Wellington Bridge will be in accordance with the *Historic Resources Act* as prescribed for historic structures. The Historic Structure site form for HS 107522 was submitted October 2020; revisions were completed as per corrections requested on April 14, 2021. The corrected site form was resubmitted August 13, 2021.

As such, the *Historic Resources Act* Requirements for the recording of the bridge have been fulfilled; **a response is requested for the City of Edmonton Wellington Bridge Replacement Project.**

Please let me know if you have any questions or concerns.

Sincerely,

A handwritten signature in black ink, appearing to read "Shannon Wright".

Shannon Wright, M.Sc.,
Project Archaeologist
Encl. (*as noted*)

sw/es

Cc: Cyril Balitbit, City of Edmonton
Brett Bodeaux, Associated Engineering

Historic Resources Application

Application Number:019932253

Revision Number: 01

Submitted Date: Aug 13, 2021

Status: In Screening

Application Type

- New/First Time Project Submission
- Amendment/Supplementary Submission (applicant must provide HRM Project Number)

HRM Project Number: 4715 - 20 - 0061 (if known)

Project Category: Transportation - Urban, Municipal or Local Road / Other Transportation Project (4715)

Application Purpose:

- Purpose:**
- Requesting HRA Approval / Requirements
 - Amendment or Update to Project Submitted Previously
 - Requesting Response to Baseline Proposal
 - Requesting Response to Baseline Study
 - Submission of Final Project Plans
 - Submission of Historic Resource Avoidance Plan
 - Update to Project Name and/or Ownership
 - Public Lands Disposition Amendment - No New Disturbance
 - Submission of As-Built Plans
 - Notification of Project Cancellation

- Lands Affected:**
- All New Lands
 - Additional Lands
 - No New Lands

Application Purpose Comments:

Development Information

- Project Type:**
- Urban Road
 - Municipal Road
 - Local Road
 - Access Road
 - Haul Road
 - Bridge
 - Culvert Improvement / Replacement
 - Borrow Pit
 - Maintenance Facility
 - Temporary Workspace
 - Snow Disposal Site
 - Airstrip
 - Airport
 - Rail Project
 - Slope / Bank Stabilization
 - Geotechnical / Geophysical Testing
 - Other

Other Project Type Description:

GIS Shapefiles attached (y/n) - Recommended yes

Approximate project area (ha) 0.490

Maximum depth of disturbance (m)
Temporary Field Authorization (TFA) number
Aboriginal Consultation Office FNC number
Other reference number

Project Identifier: Wellington Bridge Replacement Project

Project Name

Anticipated date of commencement of land development: Spring 2025

Anticipated termination of land development: Spring 2028

Key Contact

Title: _____ **Address:** 60, 4870 - 32nd Street S

First Name: Shannon **Initials:** _____

Last Name: Wright **City:** Calgary

Affiliation: Circle CRM Group Inc. **Province/State:** AB **Country:** Canada

Email: shannon@circleconsulting.ca **Postal Code/Zip:** T2B 2X3

Work Number: (403) 984-8189

Cell Number: (780) 293-6349

Fax Number: () -

Applicant Ref. #:

Proponent **The Proponent is the same as the Key Contact.**

Please complete the details below, if the Proponent is not the same as the Key Contact.

Company Name: City of Edmonton **Address:** 3rd Floor, City Hall, 1 Sir Winston Churchill Square

Contact Title: _____

Contact First Name: Cyril **Initials:** _____ **City:** Edmonton

Contact Last Name: Balitbit **Province/State:** AB **Country:** Canada

Contact Position: _____ **Postal Code/Zip:** T5J 2R7

Phone Number: (780) 496-6602

Fax Number: () -

Email: cyril.balitbit@edmonton.ca

CC Email: bodeauxb@ae.ca

Proposed Development Area

	MER	RGE	TWP	SEC	LSD List
<input type="checkbox"/>	4	25	53	1	1-2
<input type="checkbox"/>	4	25	53	1	1-2

Listed Lands Affected

MER	RGE	TWP	SEC	LSD	HRV	Category
4	25	53	1	1	1	h
4	25	53	1	1	4	a
4	25	53	1	1	5	p
4	25	53	1	2	5	a
4	25	53	1	2	5	p

Attachments *Illustrative material is required prior to submittal of the application. If available, also supply Justification and Action Matrix documents.*

	Upload/Created Date	Type	Description
View	Apr 15, 2021	GIS Data File	Development_Footprint
View	Aug 13, 2021	Additional Supporting Material	HS Site Form
View	Aug 13, 2021	Additional Supporting Material	HRA Requirements
View	Aug 13, 2021	Illustrative Material	NTS Illustration
View	Aug 13, 2021	Illustrative Material	Ortho Illustration
View	Aug 13, 2021	Illustrative Material	Project Area

Emails

Description	Sent	From
--------------------	-------------	-------------

Additional Information

Comments:

- An Archaeological Permit application has been submitted and studies are pending - requesting HRA Requirements.**
- An Archaeological Permit Report is being submitted in conjunction with this application.**
If so, provide the Permit Number:
- A Palaeontological Permit application has been submitted and studies are pending - requesting HRA Requirements.**
- A Palaeontological Permit Report is being submitted in conjunction with this application.**

[? Help](#)

[▶ Back To Submission List](#)

[▶ Data Entry](#)

[▶ Data Entry Summary](#)

Heritage Survey eForm Submissions

Cancel

Save

Heritage Survey Site Form - Data Entry

¹Key: HS 107522

²Site name: Wellington Bridge

³Other Name(s)

⁴Site Type

0909 - Transportation - Road Facility: Bridge or Tunnel

Edit

Delete

ATS Legal Description

⁵ LSD	⁶ Quarter	⁷ Section	⁸ Township	⁹ Range	¹⁰ Meridian
2	SE	1	63	26	4

Edit

Delete

PBL

¹⁵Address:

¹⁶Number:

¹⁷Street:

¹⁸Avenue:

102 NW

¹⁹Other:

²⁰Town:

Edmonton

²¹Near Town:

²²County:

UTM

²⁷ Zone	²⁸ Easting	²⁹ Northing	³⁰ Datum	³¹ Coordinate Determination
12	331667	5935679	NAD83	Digital Maps

Edit

Delete

LAT

³² Latitude	³³ Longitude	³⁴ Datum	³⁵ Coordinate Determination
------------------------	-------------------------	---------------------	--

Media



File Name: 20-R0015-01.jpg

³⁶Type: Negative

³⁷Number: 20-R0015-01

³⁸View: North

³⁹Date: 2020/10/08

⁴⁰Source: Circle CRM Group Inc.

Edit

Delete

³⁶Type: Negative

³⁷Number: 20-R0015-07

³⁸View: West

³⁹Date: 2020/10/08

⁴⁰Source: Circle CRM Group Inc.

Edit

Delete



File Name: 20-R0015-07.jpg



File Name: 20-R0015-06.jpg



File Name: 20-R0015-12.jpg

³⁶Type: Negative
³⁷Number: 20-R0015-06
³⁸View: Northeast
³⁹Date: 2020/10/08
⁴⁰Source: Circle CRM Group Inc.

Edit Delete

³⁶Type: Negative
³⁷Number: 20-R0015-12
³⁸View: South
³⁹Date: 2020/10/08
⁴⁰Source: Circle CRM Group Inc.

Edit Delete

⁴¹Style +

--	--

⁴²Plan Shape +

--	--

⁴³Storeys +

--	--

⁴⁴Foundation +

--	--

⁴⁵Superstructure +

3018 - Poured Concrete	Edit Delete
3019 - Metal	Edit Delete

⁴⁶Superstructure Cover +

2401 - Asphalt	Edit Delete

⁴⁷Roof Structure +

--	--

⁴⁸Roof Cover +

--	--

⁴⁹Exterior Codes +

--	--

⁵⁰Exterior:

The bridge measures 77 m long along 102nd Avenue and 14 m wide. There are four lanes of traffic on the bridge deck; two heading west and two heading east, and a concrete pedestrian sidewalk on the north and south sides of the bridge. The barricades along the north and south edges of the bridge are comprised of five sets of squat poured concrete columns with rectangular spacers between each set of columns sitting on a concrete base and topped with a concrete lintel that spans the length of the bridge. A low metal guardrail separates the sidewalks from the vehicular lanes. The bridge is supported by a large central arch flanked by a smaller arch on each side. Two sets of four smaller arches, one

51Interior:

52Environment: The bridge carries 102 Ave over an unnamed tributary creek of the North Saskatchewan River, as well as a paved multi-use trail. The creek flows within the bottom of a deeply incised u-shaped valley. Vegetation within the valley consists of aspen, spruce, alder, and rose.

53Condition:

54Alterations:

Construction +

55Construction	56Date	57Code	
-----------------------	---------------	---------------	--

Usage +

58Usage	59Date	60Code	
----------------	---------------	---------------	--

Owner +

61Owner	62Date		
----------------	---------------	--	--

63Architect:

64Builder:

65Craftsman:

66History:

The Bridge was constructed in 1932 and spanned Wellington Ravine, which was likely named for its proximity to Wellington Crescent. The bridge is located in the Glenora neighbourhood which has existed since 1912.

67 Sources:

Berger, Carol
2005 Naming Edmonton From Ada to Zoie. The University of Alberta Press. Edmonton

Historic Resources Inventory Pdf.
https://webdocs.edmonton.ca/landsales/ici_catalogue/jasper_triangle/HistoricResourcesInventory.pdf (Accessed: April 15, 2021)

OFFICE USE

Status			+
68 Status	69 Date		
Designation Status			+
70 Designation Status	71 Date		
72 Priority			+
73 Geo Code:	74 Borden Number:	75 Register:	
Internet Link			+
76 Link	77 Date		
Internet Link Description			+
78 Description	79 Date		
Internet Link Type			+
80 Type	81 Date		
Internet Link Title			+
82 Title	83 Date		
84 Related Significant Sites Record:			

Cancel

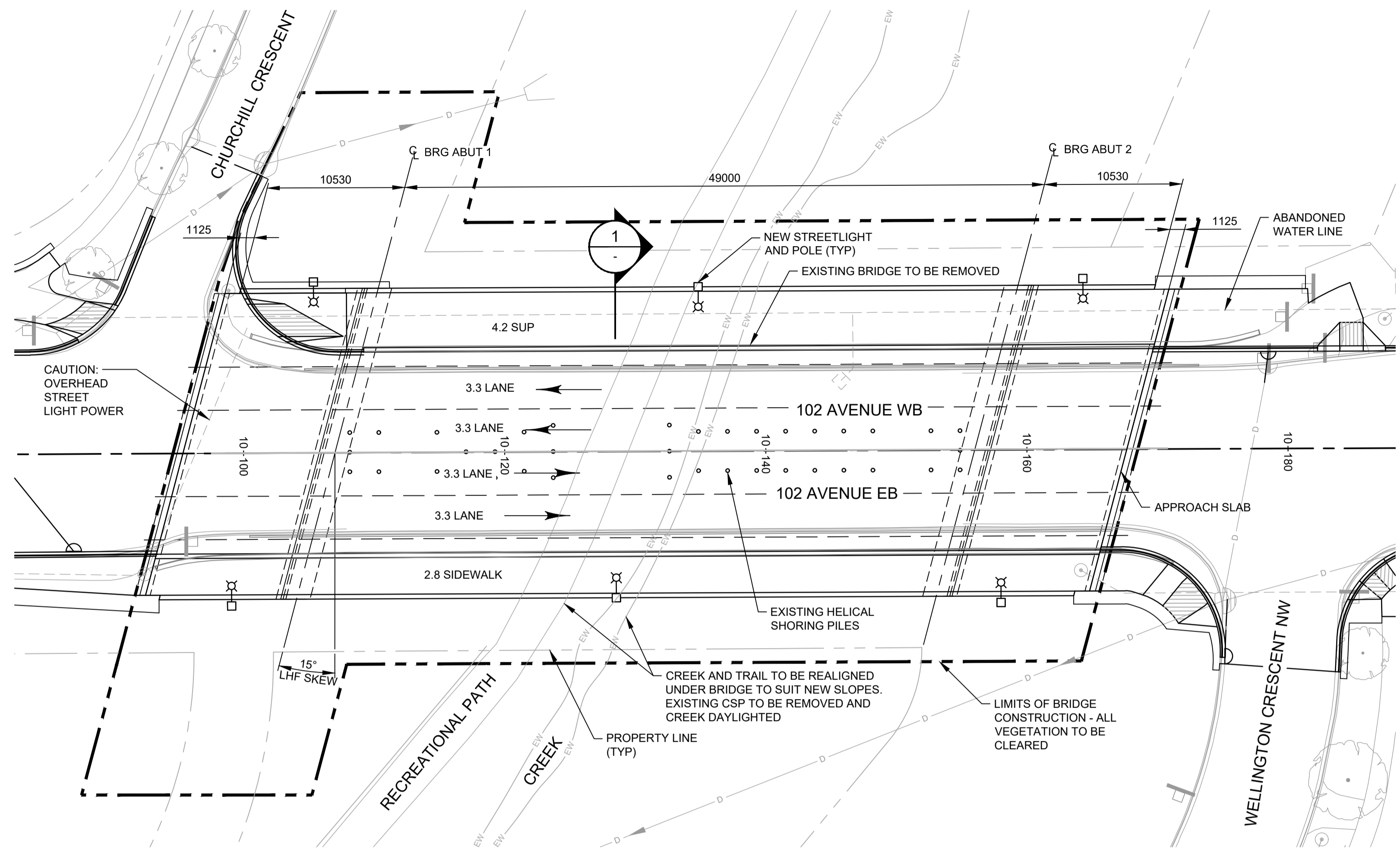
Save



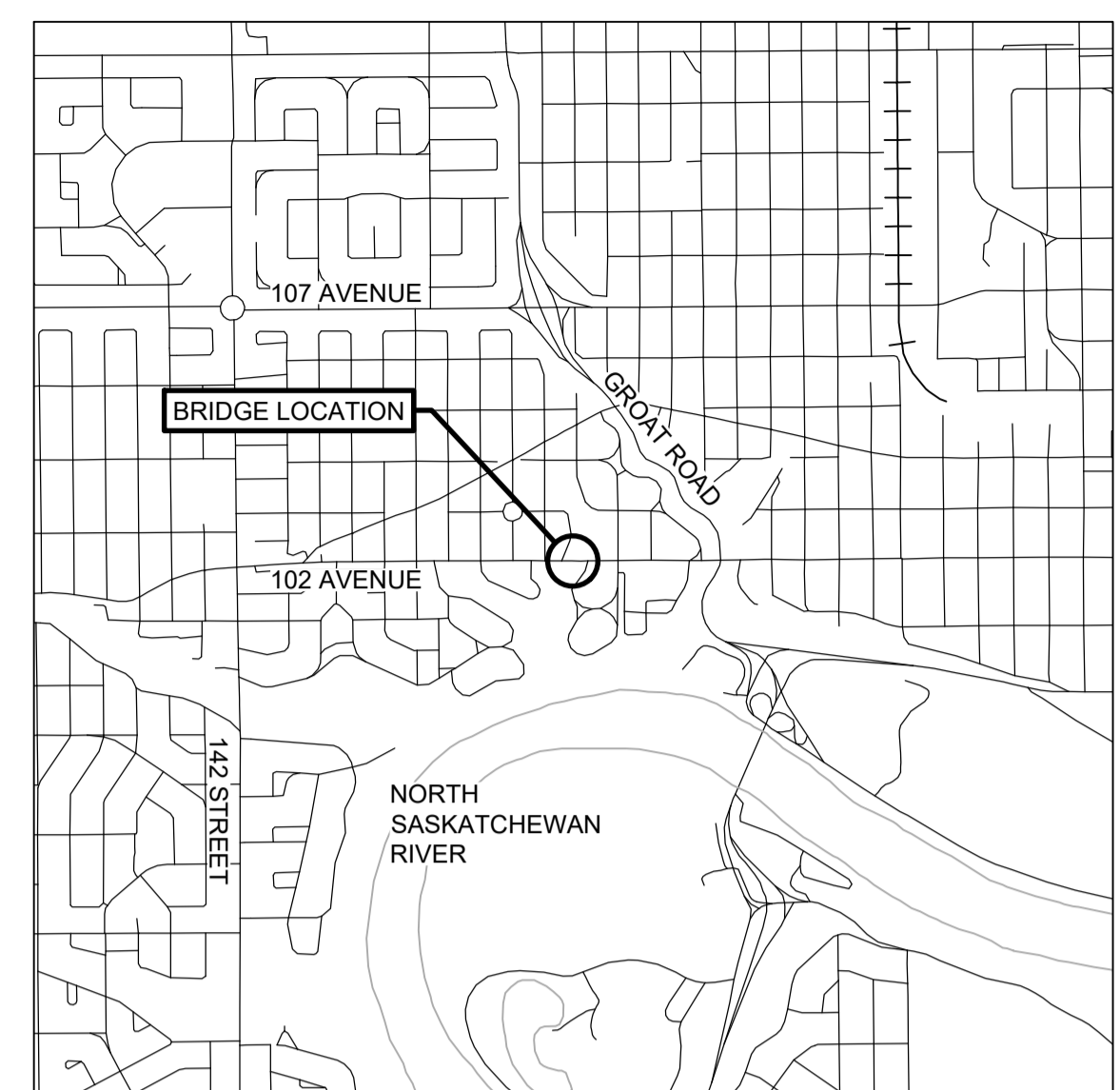
[HeRMIS Home](#) | [Search](#) | [Site Map](#) | [Contact Us](#) | [Privacy Statement](#)
 The user agrees to the terms and conditions set out in the [Copyright and Disclaimer statement](#).
 © 2005 [Government of Alberta](#).



APPENDIX C - PRELIMINARY DESIGN DRAWINGS



PLAN 1:250

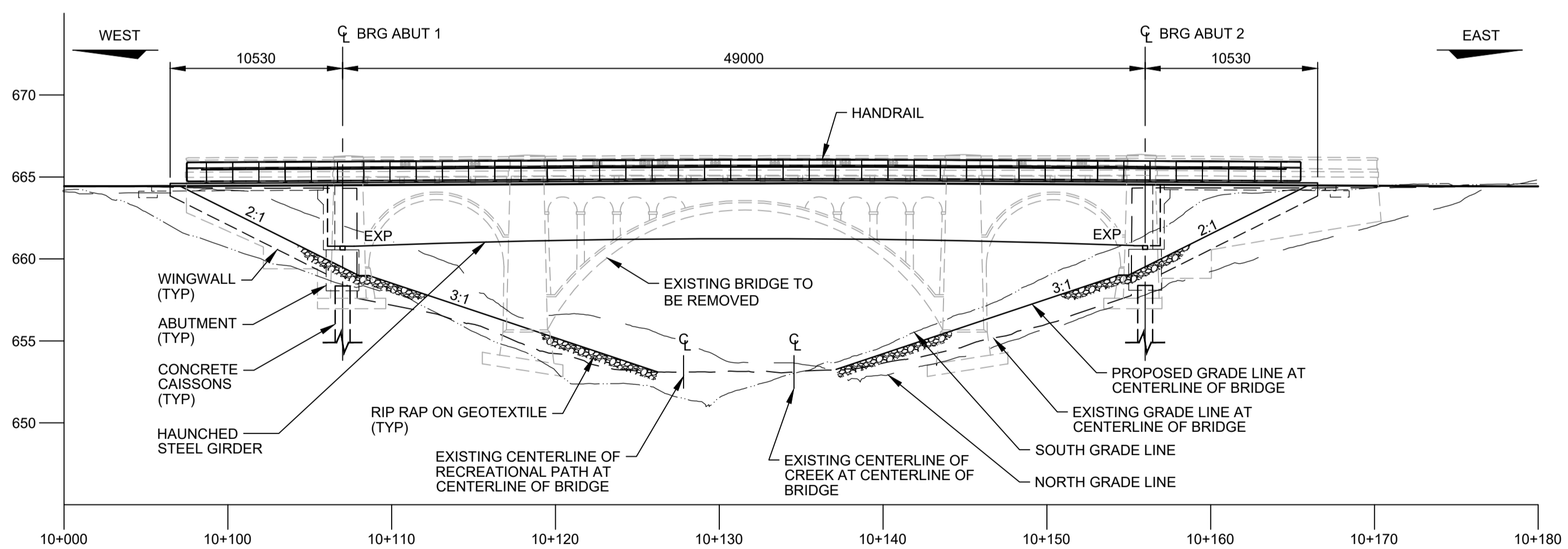


PLAN 1:25 000
SITE MAP

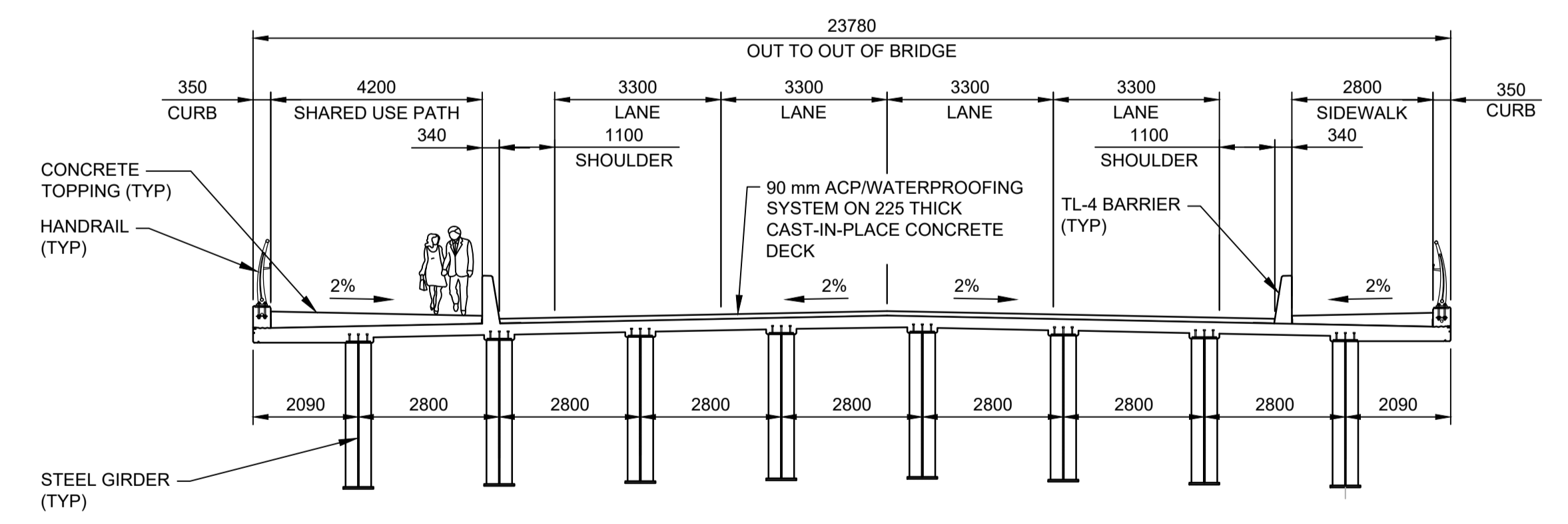
NOTES

1. ALL DIMENSIONS ARE GIVEN IN MILLIMETERS UNLESS NOTED OTHERWISE

SURFACE UTILITY LEGEND	
○	TROLLEY POLES
○	WOODEN POWER POLE
○	POWER POLE
○	POWER POLE (SURVEYED)
□	STREET LIGHT POLE
○	STREET LIGHT POLE (SURVEYED)
○	POWER MANHOLE
○	POLE ANCHOR
○	TRAFFIC POLE
○	TRAFFIC POLE (SURVEYED)
□	TRAFFIC CABINET
□	NEW LIGHTPOLE
○	TELEPHONE MANHOLE
○	TELEPHONE POLE
○	DRAINAGE MANHOLE (SANITARY)
○	DRAINAGE MANHOLE (STORM)
○	CATCH BASIN MANHOLE
○	CATCH BASIN
○	FIRE HYDRANT
○	FIRE HYDRANT (SURVEYED)
○	WATER VALVE
○	WATER TEE
○	ANODE
○	ROADWAY SIGN



ELEVATION 1:250
LOOKING NORTH



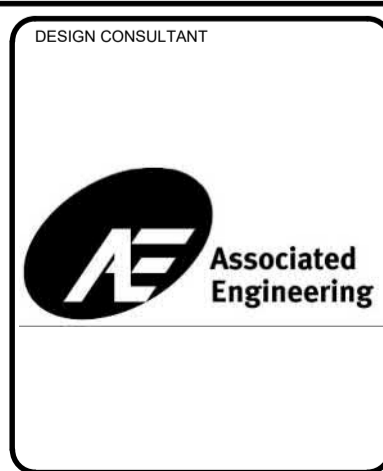
SECTION 1:100
LOOKING EAST

PRELIMINARY/
FOR DISCUSSION
NOT FOR CONSTRUCTION

NO.	REVISIONS	BY	DATE	APPD
1	ISSUED FOR PRELIMINARY REVIEW	##	#####	##

PROGRAM NO.	XXXX
CONTRACT NO.	XXXX
CONSTRUCTION ENGINEER	DATE
GENERAL SUPERVISOR	DATE

CONTRACTOR	
SURVEYOR	
DATE	
FILE NUMBER	
CONSTRUCTION ENGINEER	DATE
GENERAL SUPERVISOR	DATE



APPROVED FOR CONSTRUCTION

SUPERVISOR
TRANSPORTATION DESIGN
DEPARTMENT / BRANCH

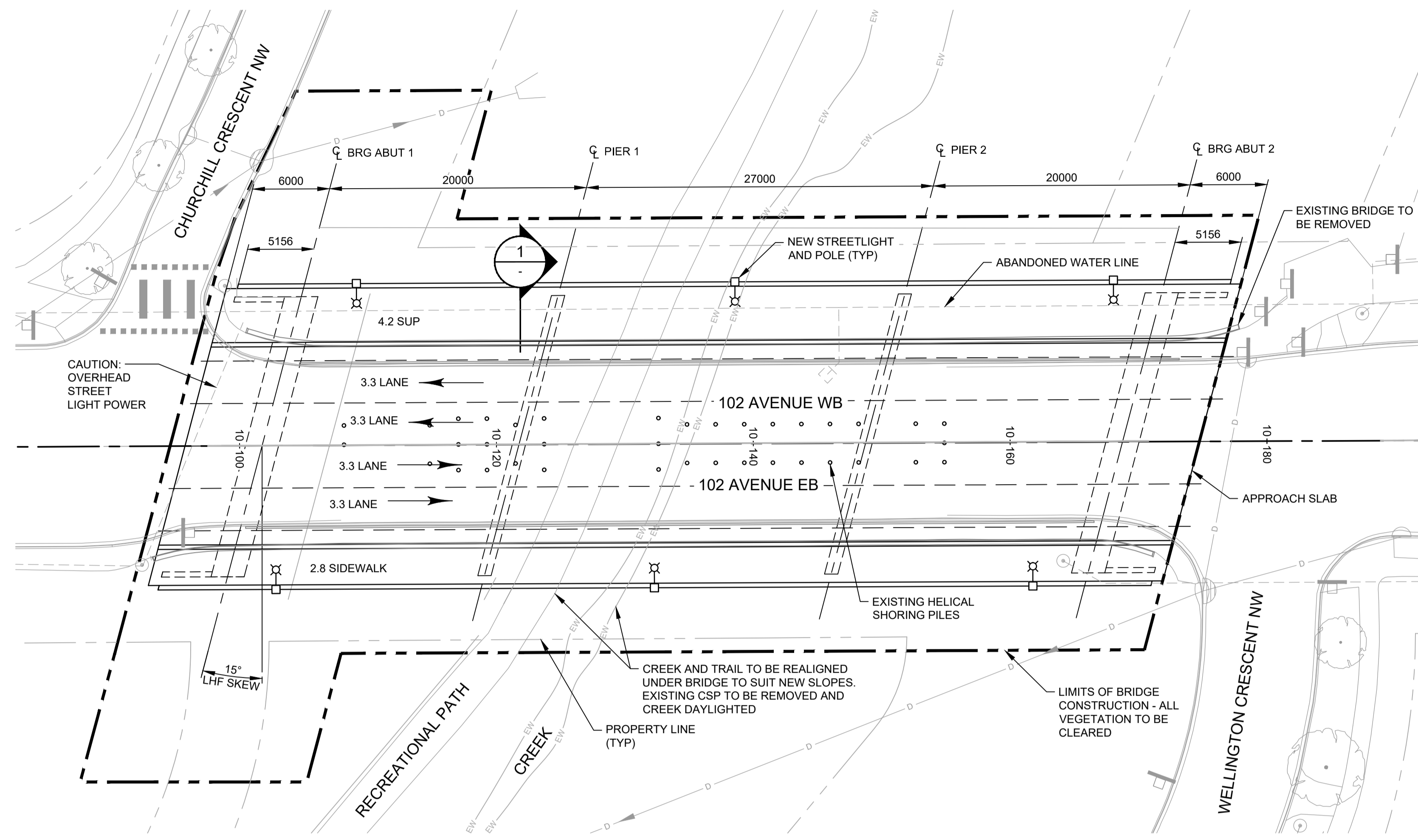
APPROVAL	DATE
----------	------

TRANSPORTATION INFRASTRUCTURE DELIVERY	DATE			
SCALE	SCALES SHOWN ARE CORRECT FOR FULL SIZE PLOTS (A1 SHEET SIZE)			
DRAWN	T. KIRK	DATE	FEB 2021	
DESIGNED	J. GAGNE	DATE	FEB 2021	
MANAGING CONSULTANT	CHECKED	M. TOKAR	DATE	FEB 2021

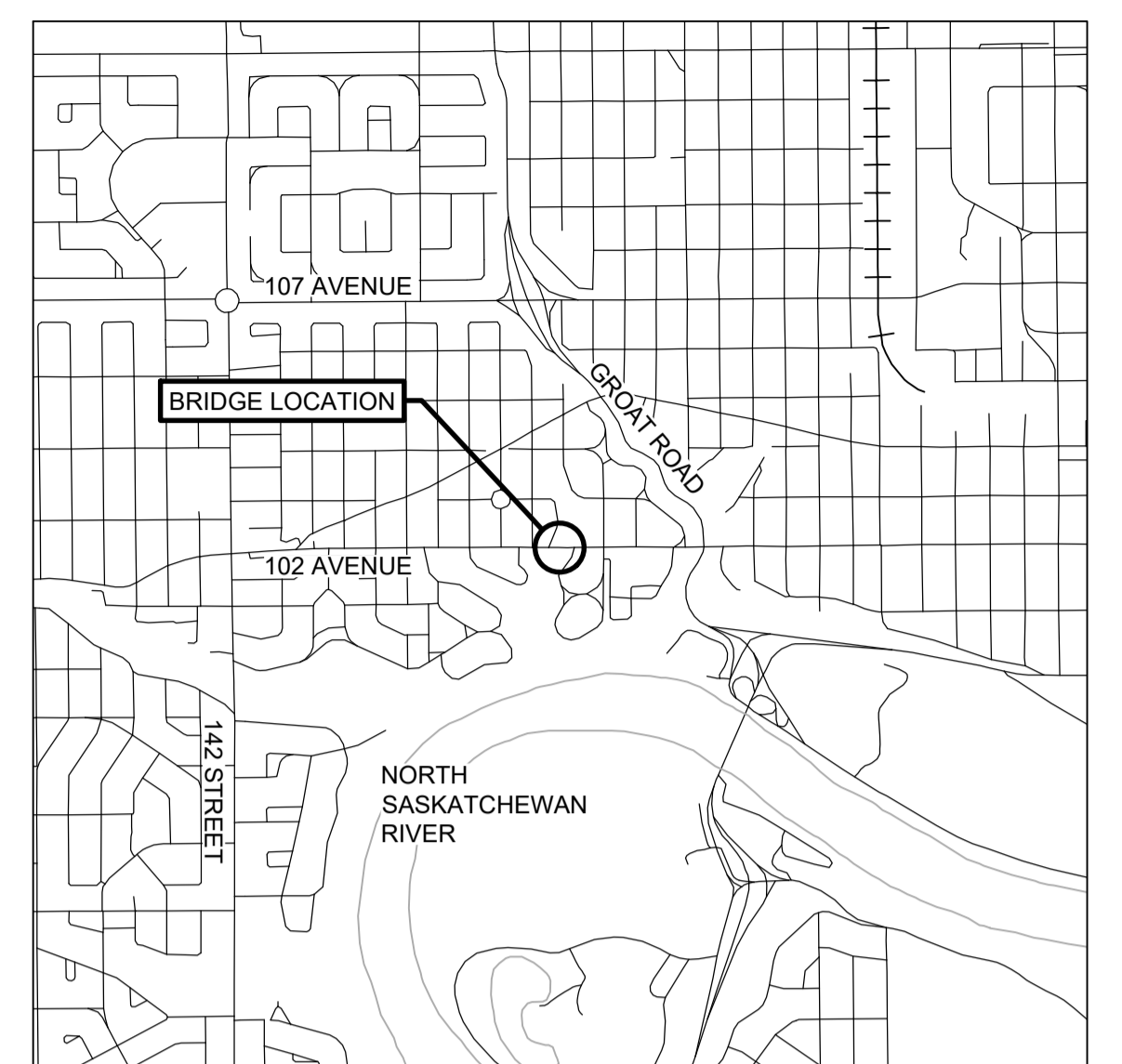
Edmonton INTEGRATED INFRASTRUCTURE SERVICES
INFRASTRUCTURE DELIVERY BRANCH

**102 AVENUE OVER RAVINE
WELLINGTON BRIDGE REPLACEMENT**
SINGLE SPAN STEEL GIRDER BRIDGE

FIGURE 1



PLAN 1:250

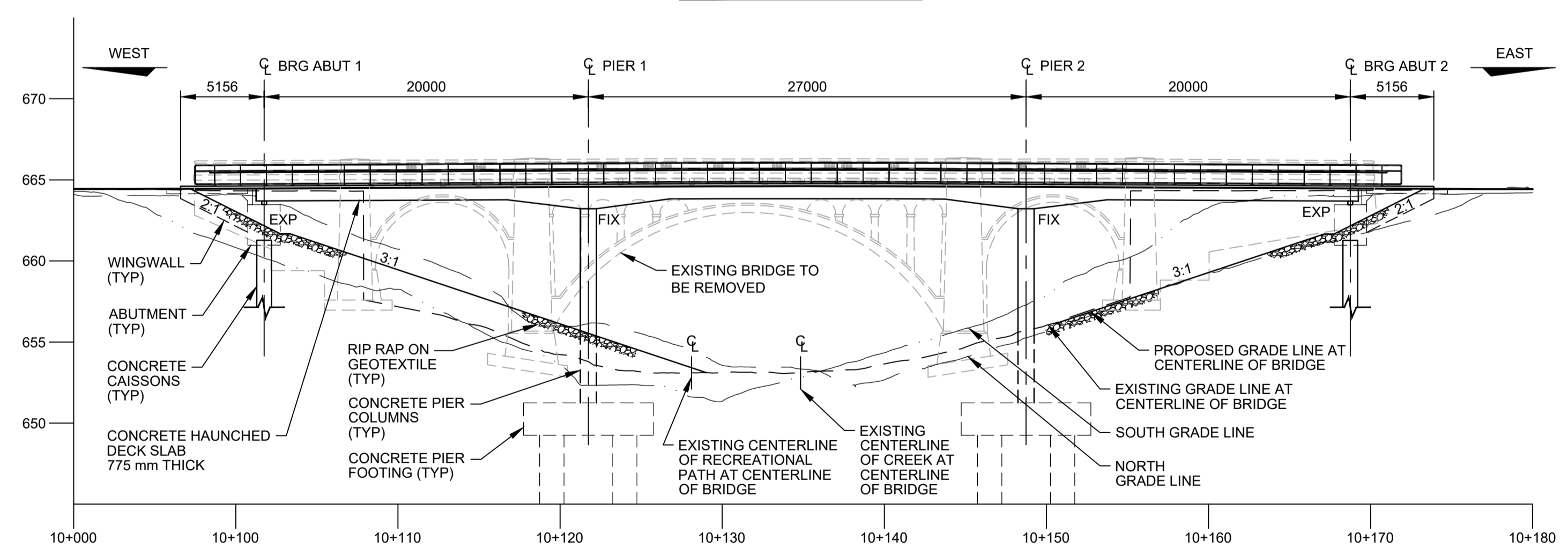


PLAN 1:25 000
SITE MAP

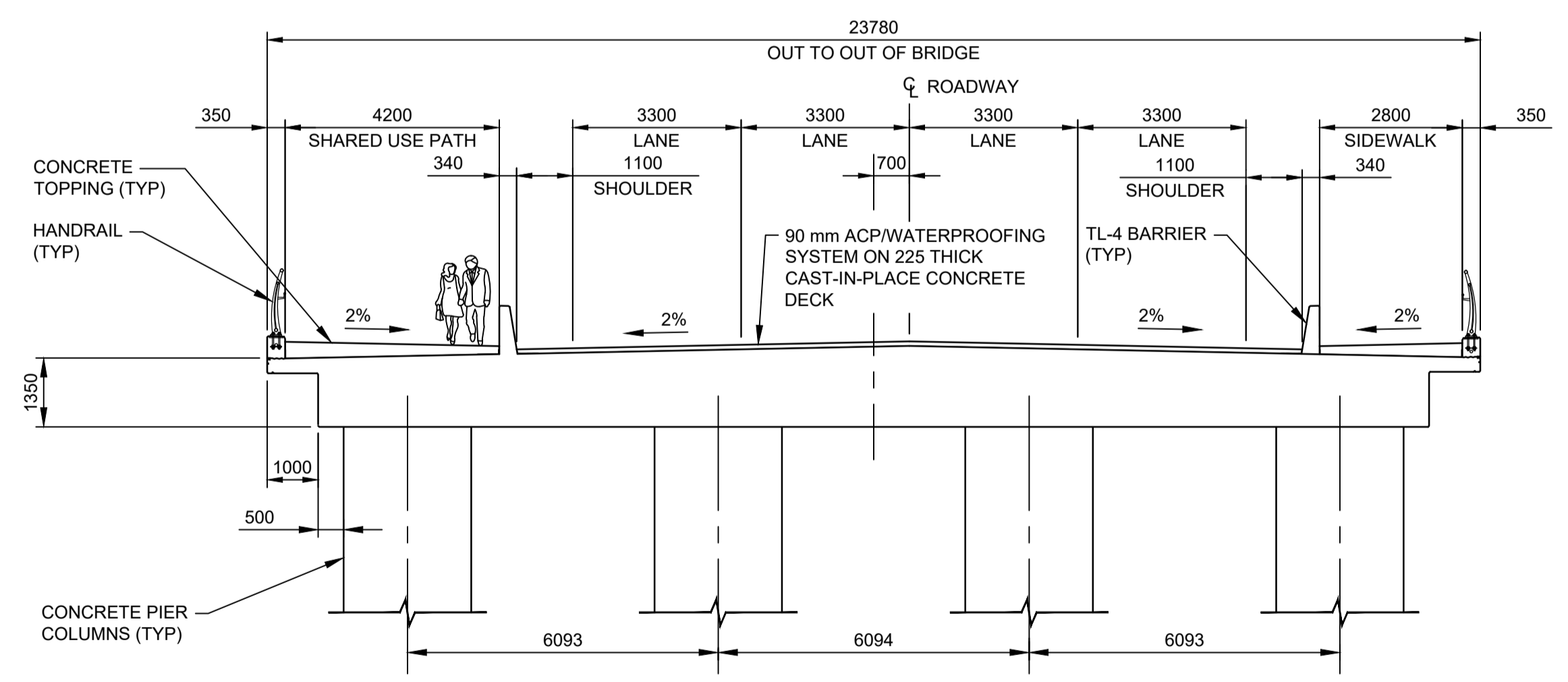
NOTES

- ALL DIMENSIONS ARE GIVEN IN MILLIMETERS UNLESS NOTED OTHERWISE

SURFACE UTILITY LEGEND			
○	TROLLEY POLES	⊕	TELEPHONE MANHOLE
○	WOODEN POWER POLE	⊕	TELEPHONE POLE
⊕	POWER POLE	⊕	DRAINAGE MANHOLE (SANITARY)
⊕	POWER POLE (SURVEYED)	⊕	DRAINAGE MANHOLE (STORM)
⊕	STREET LIGHT POLE	⊕	CATCH BASIN MANHOLE
⊕	STREET LIGHT POLE (SURVEYED)	⊕	CATCH BASIN
⊕	POWER MANHOLE	⊕	FIRE HYDRANT
⊕	POLE ANCHOR	⊕	FIRE HYDRANT (SURVEYED)
⊕	TRAFFIC POLE	⊕	WATER VALVE
⊕	TRAFFIC POLE (SURVEYED)	⊕	WATER TEE
⊕	TRAFFIC CABINET	⊕	ANODE
⊕	NEW LIGHTPOLE	⊕	ROADWAY SIGN



ELEVATION 1:250
LOOKING NORTH



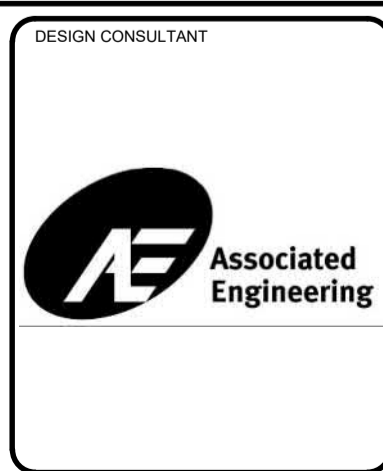
SECTION 1:100
LOOKING EAST

PRELIMINARY/
FOR DISCUSSION
NOT FOR CONSTRUCTION

NO.	REVISIONS	BY	DATE	APPD
1	ISSUED FOR PRELIMINARY REVIEW	##	#####	##

PROGRAM NO.	XXXX
CONTRACT NO.	XXXX

CONSTRUCTION RETURN	DESIGN CONSULTANT
CONTRACTOR	
SURVEYOR	
DATE	
FILE NUMBER	
CONSTRUCTION ENGINEER	DATE
GENERAL SUPERVISOR	DATE



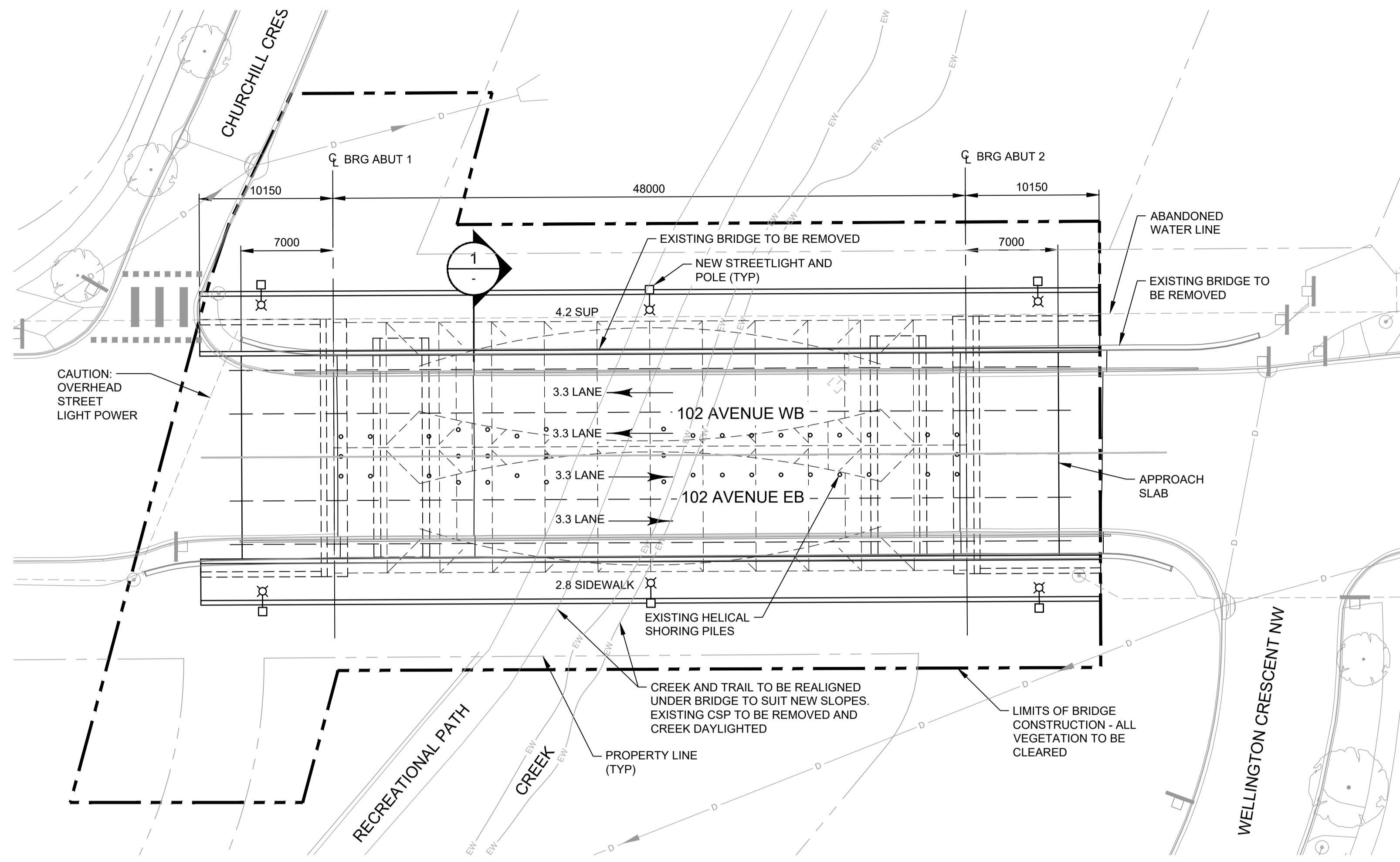
APPROVED FOR CONSTRUCTION

SUPERVISOR	DATE
TRANSPORTATION DESIGN	
DEPARTMENT / BRANCH	APPROVAL
	DATE

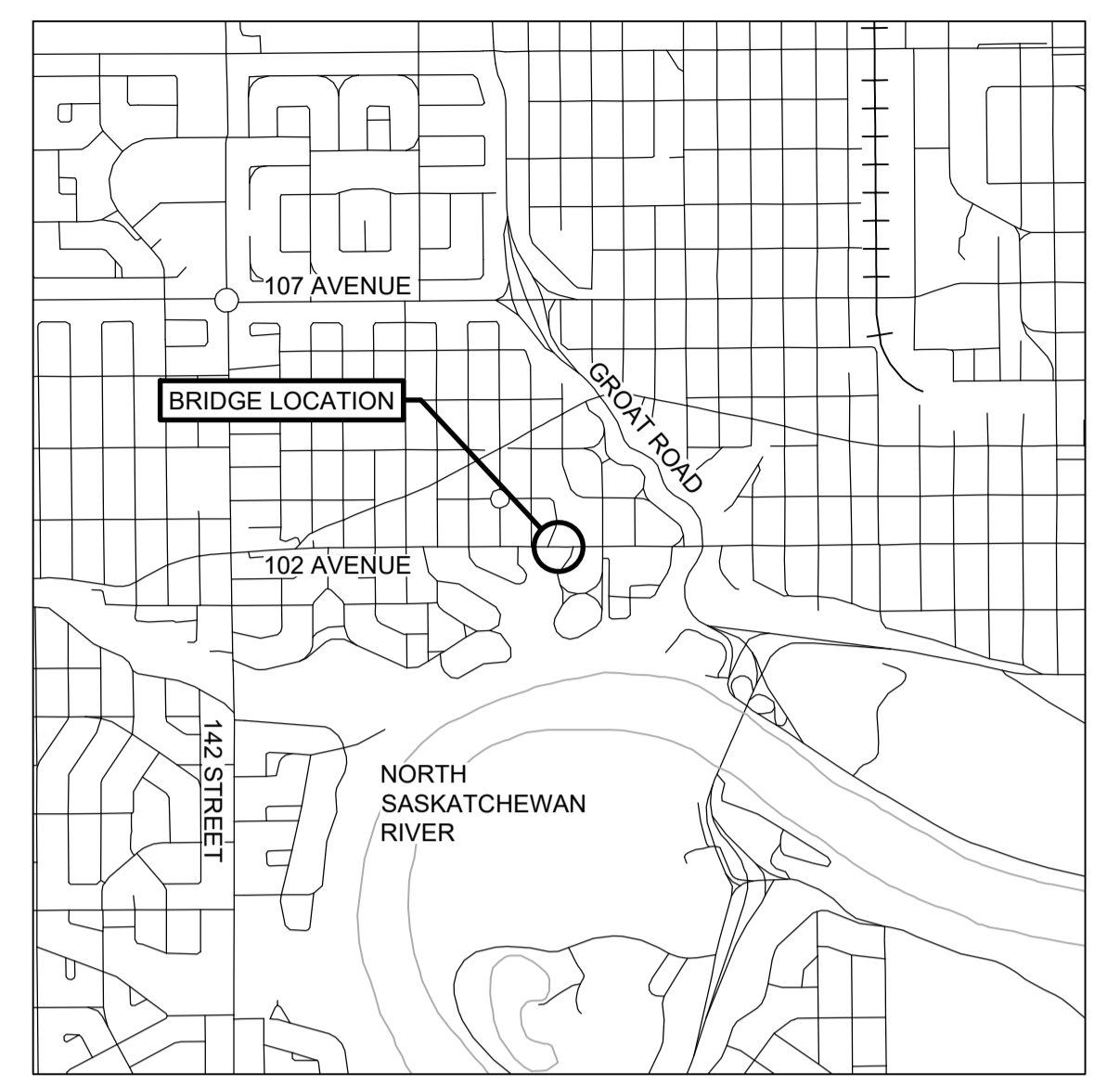
TRANSPORTATION INFRASTRUCTURE DELIVERY	DATE
SCALE	SCALES SHOWN ARE CORRECT FOR FULL SIZE PLOTS (A1 SHEET SIZE)
MANAGING CONSULTANT	

DRAWN	T. KIRK	DATE	FEB 2021
DESIGNED	J. GAGNE	DATE	FEB 2021
CHECKED	M. TOKAR	DATE	FEB 2021

INTEGRATED INFRASTRUCTURE SERVICES
 INFRASTRUCTURE DELIVERY BRANCH
102 AVENUE OVER RAVINE
WELLINGTON BRIDGE REPLACEMENT
 THREE SPAN HAUNCHED CONCRETE DECK SLAB
FIGURE 2



PLAN 1:250

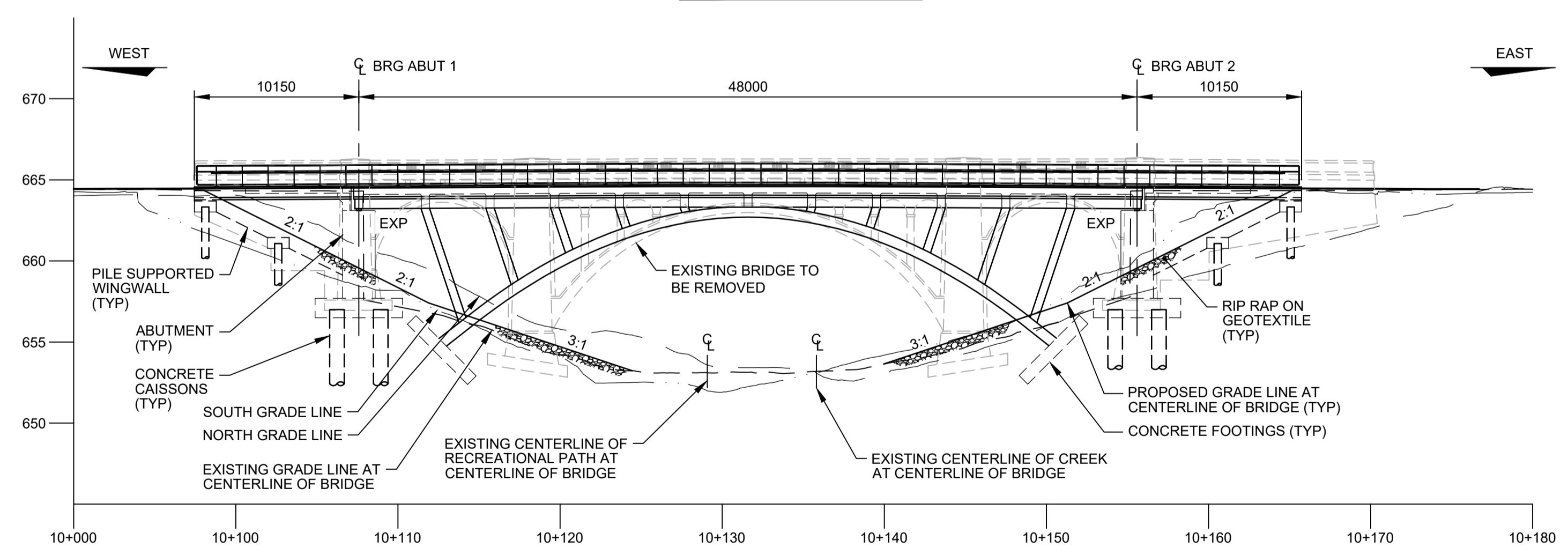


PLAN 1:25 000
SITE MAP

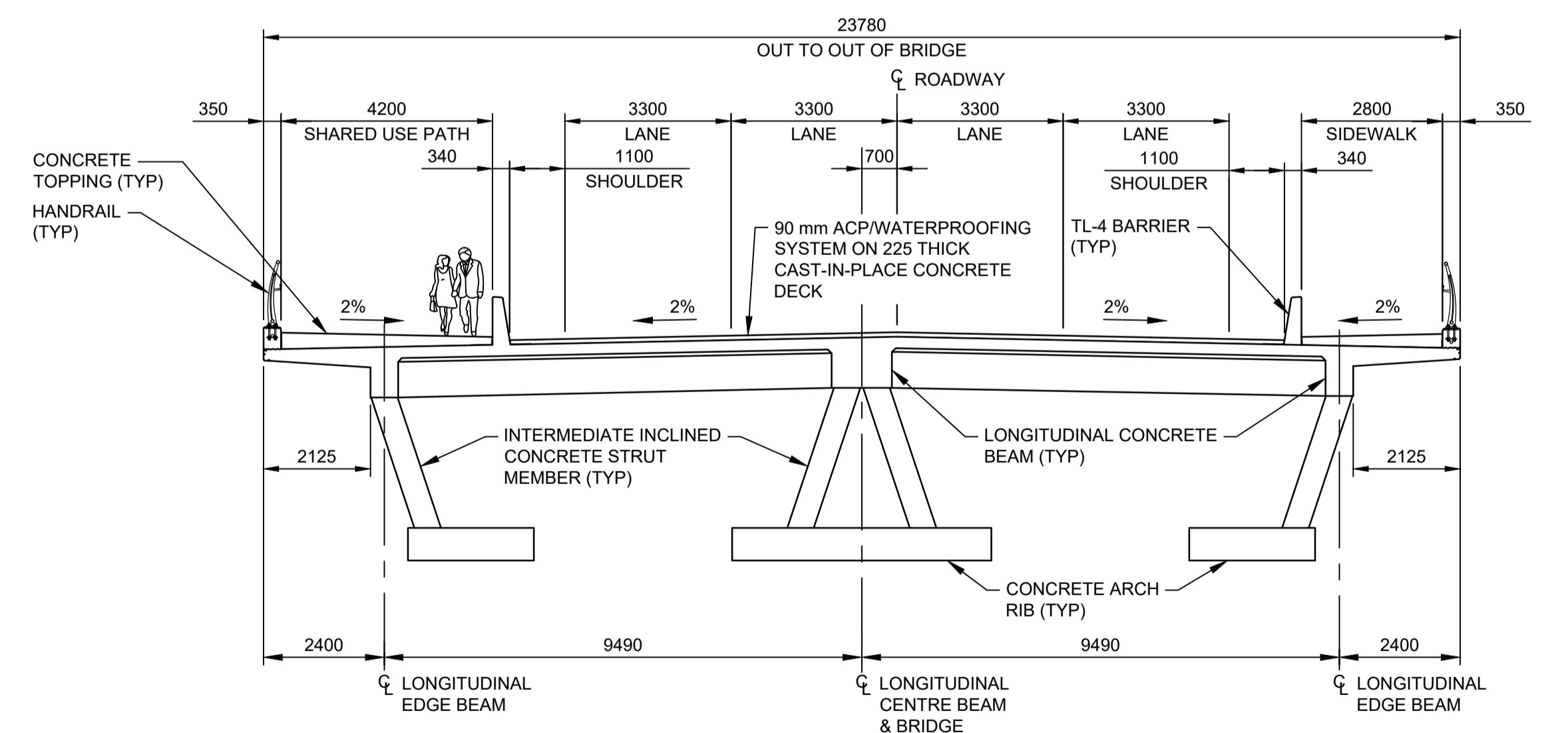
NOTES

- ALL DIMENSIONS ARE GIVEN IN MILLIMETERS UNLESS NOTED OTHERWISE

SURFACE UTILITY LEGEND	
	TELLEPHONE MANHOLE
	TELLEPHONE POLE
	DRAINAGE MANHOLE (SANITARY)
	DRAINAGE MANHOLE (STORM)
	CATCH BASIN MANHOLE
	CATCH BASIN
	FIRE HYDRANT
	FIRE HYDRANT (SURVEYED)
	WATER VALVE
	WATER TEE
	ANODE
	ROADWAY SIGN



ELEVATION 1:250
LOOKING NORTH

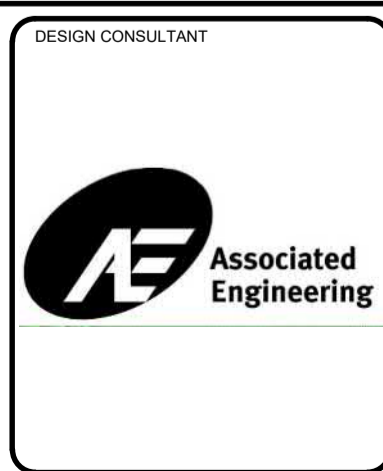


SECTION 1:100
LOOKING EAST

7				
6				
5				
4				
3				
2				
1	ISSUED FOR PRELIMINARY REVIEW	##	#####	##
NO.	REVISIONS	BY	DATE	APPD

PROGRAM NO.	
CONTRACT NO.	XXXX
NO.	
4	
3	
2	
1	
NO.	ISSUE
	BY
	DATE

CONSTRUCTION RETURN	DESIGN CONSULTANT
CONTRACTOR	
SURVEYOR	
DATE	
FILE NUMBER	
CONSTRUCTION ENGINEER	DATE
GENERAL SUPERVISOR	DATE



APPROVED FOR CONSTRUCTION	

SUPERVISOR	
TRANSPORTATION DESIGN	
DEPARTMENT / BRANCH	
APPROVAL	
DATE	

TRANSPORTATION INFRASTRUCTURE DELIVERY	DATE
SCALE	
SCALES SHOWN ARE CORRECT FOR FULL SIZE PLOTS (A1 SHEET SIZE)	
MANAGING CONSULTANT	
DRAWN	T. KIRK
DATE	FEB 2021
DESIGNED	J. GAGNE
DATE	FEB 2021
CHECKED	M. TOKAR
DATE	FEB 2021

	INTEGRATED INFRASTRUCTURE SERVICES INFRASTRUCTURE DELIVERY BRANCH
	102 AVENUE OVER RAVINE WELLINGTON BRIDGE REPLACEMENT MODERN ARCH
FIGURE 3	



PHOTO
STEEL GIRDER OPTION



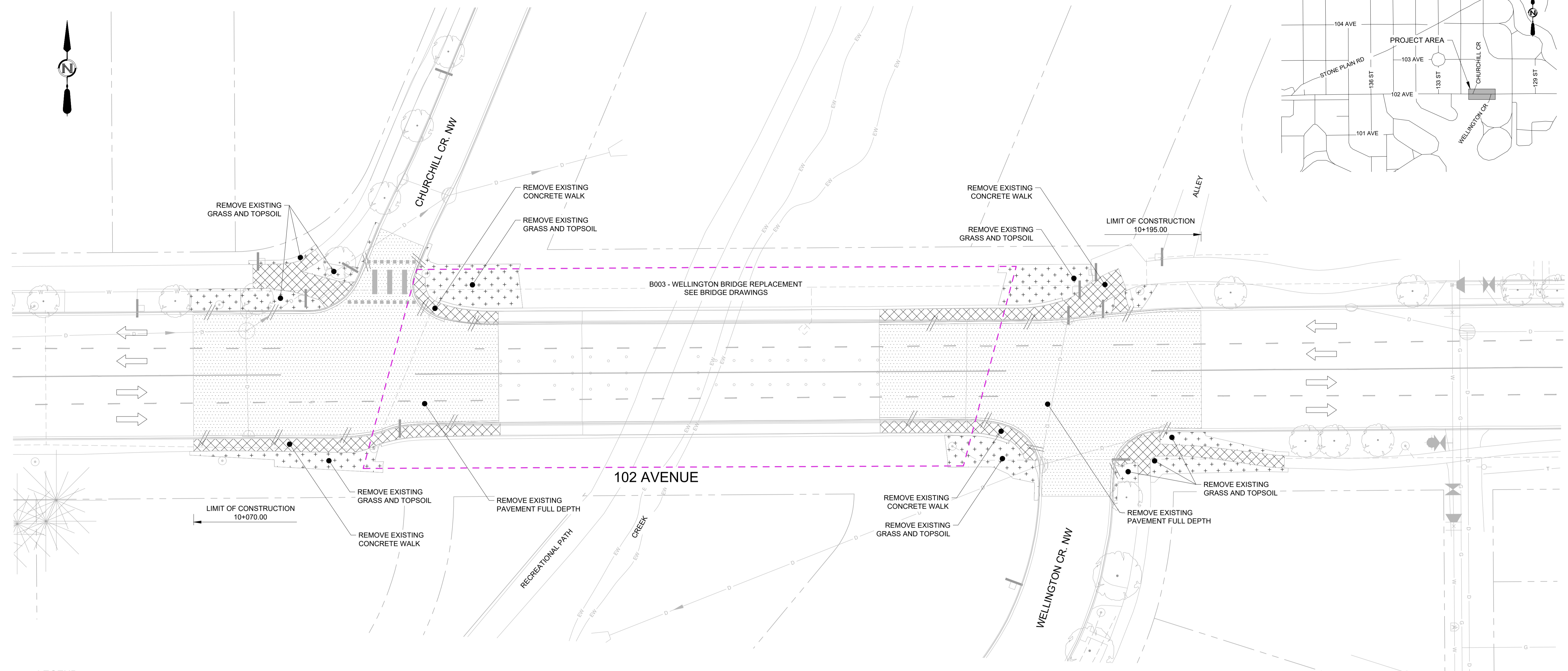
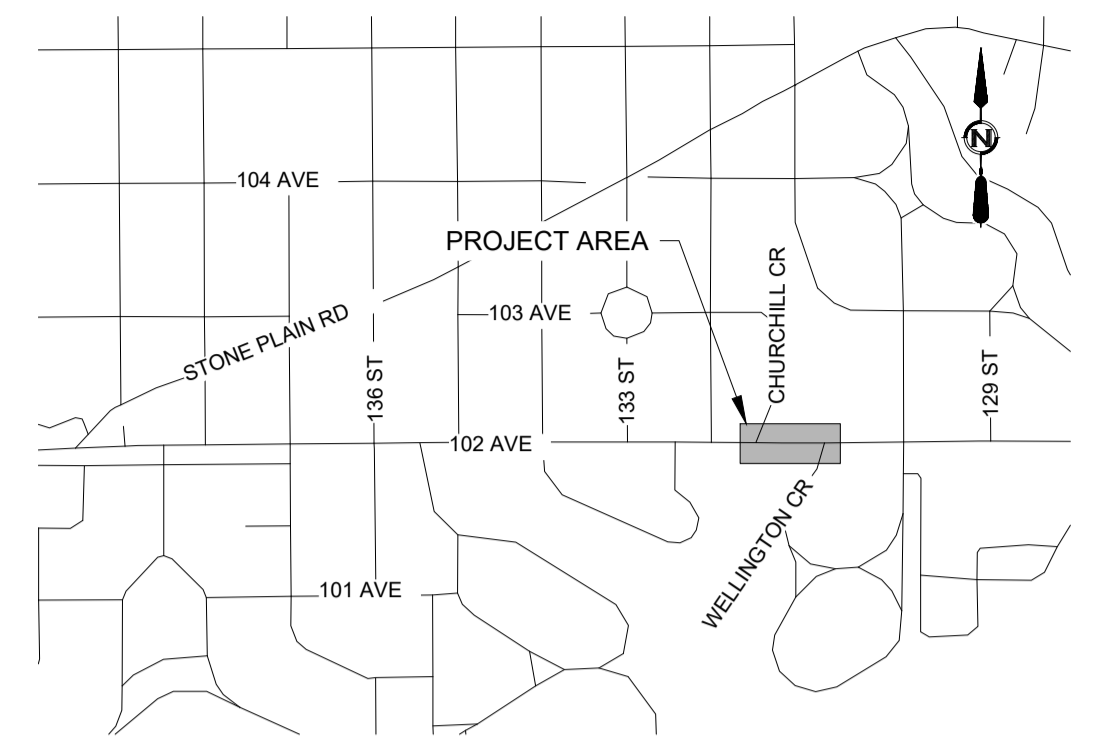
PHOTO
MODERN ARCH OPTION



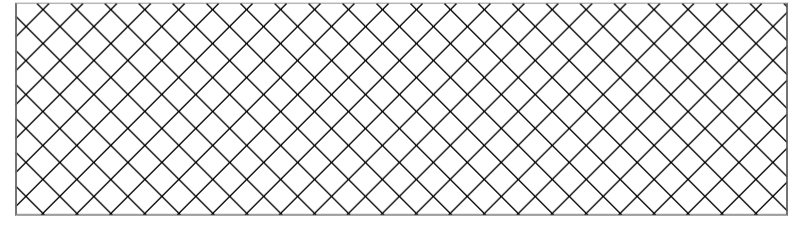
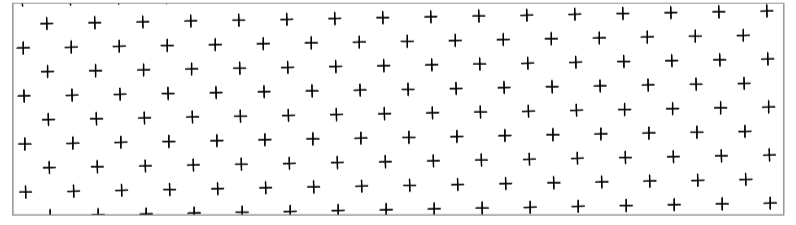

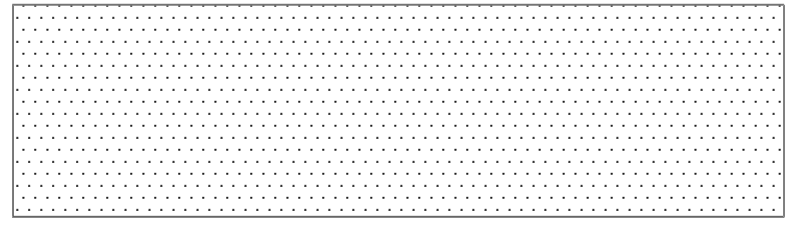
PHOTO
THREE SPAN HAUNCHED CONCRETE GIRDER OPTION

7						PROGRAM NO. _____	CONSTRUCTION RETURN	DESIGN CONSULTANT				TRANSPORTATION INFRASTRUCTURE DELIVERY	DATE	Edmonton	INTEGRATED INFRASTRUCTURE SERVICES
6						CONTRACT NO. XXXX	CONTRACTOR _____					SCALE	DRAWN	DATE	PROJECT
5						SURVEYOR _____						SCALES SHOWN ARE CORRECT FOR FULL SIZE PLOTS (A1 SHEET SIZE)	T. KIRK	FEB 2021	102 AVENUE OVER RAVINE WELLINGTON BRIDGE REPLACEMENT 3D RENDERINGS
4						DATE _____						MANAGING CONSULTANT	J. GAGNE	FEB 2021	
3						FILE NUMBER _____									
2							CONSTRUCTION ENGINEER _____ DATE _____						CHECKED	M. TOKAR	FEB 2021
1	ISSUED FOR PRELIMINARY REVIEW	##	#####	##			GENERAL SUPERVISOR _____ DATE _____		APPROVED FOR CONSTRUCTION			SUPERVISOR			
NO.	REVISIONS	BY	DATE	APPD	NO.	ISSUE	BY	DATE				DEPARTMENT / BRANCH	APPROVAL	DATE	

FIGURE 4



LEGEND

<p>CONCRETE REMOVAL</p> 	<p>GRASS AND TOSOIL REMOVAL</p> 
<p>CURB AND / OR GUTTER REMOVAL</p> 	<p>FULL DEPTH PAVEMENT REMOVAL</p> 

1 PLAN 1:250
102 AVENUE

NOTES:


- REMOVE ALL LOOSE ASPHALT IN GUTTERS PRIOR TO OVERLAY.
- REMOVE EXISTING CURB, GUTTER AND WALK AS REQUIRED.
- FINAL LIMITS OF BASE REMOVAL, CURB REPLACEMENT AND GRINDING AT MATCH LOCATIONS TO BE FIELD DETERMINED.
- SAW-CUT AREAS OF BASE REMOVAL.

7	##	##	##	
6	##	##	##	##
5	##	##	##	##
4	PRELIMINARY DESIGN - 99% SUBMISSION	WM	20MAY21	TA
3	PRELIMINARY DESIGN - 90% SUBMISSION	WM	01MAR21	TA
2	ISSUED FOR REVIEW	JJ	17 DEC 20	MK
1	ISSUED FOR REVIEW	JJ	4 DEC 20	CP
NO.	REVISIONS	BY	DATE	APPD

PROGRAM NO.			
CONTRACT NO.			
NO.	ISSUE	BY	DATE

CONSTRUCTION RETURN	
CONTRACTOR	
SURVEYOR	
DATE	
FILE NUMBER	
CONSTRUCTION ENGINEER	DATE
GENERAL SUPERVISOR	DATE

DESIGN CONSULTANT



Associated Engineering

APPROVED FOR CONSTRUCTION	
---------------------------	--

--	--

TRANSPORTATION PLANNING AND DESIGN SUPERVISOR	
DEPARTMENT / BRANCH	APPROVAL
	DATE

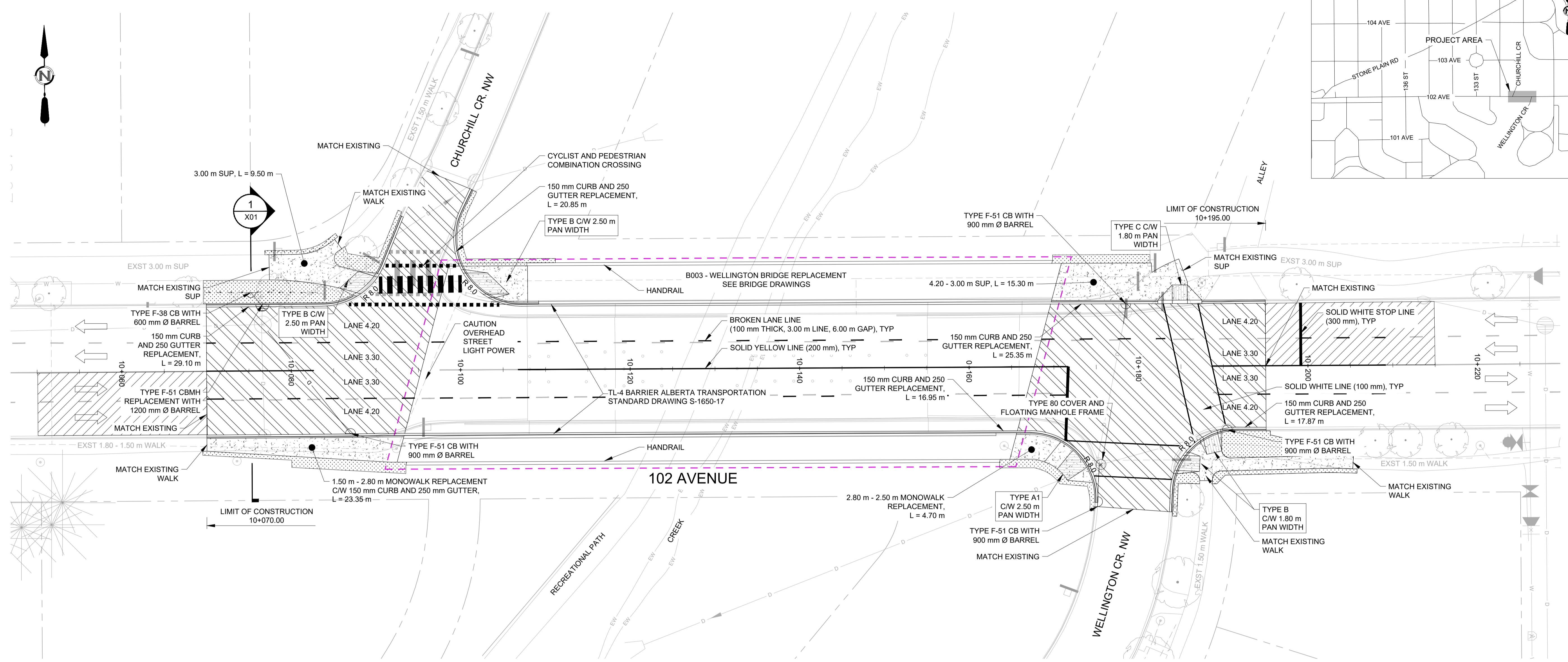
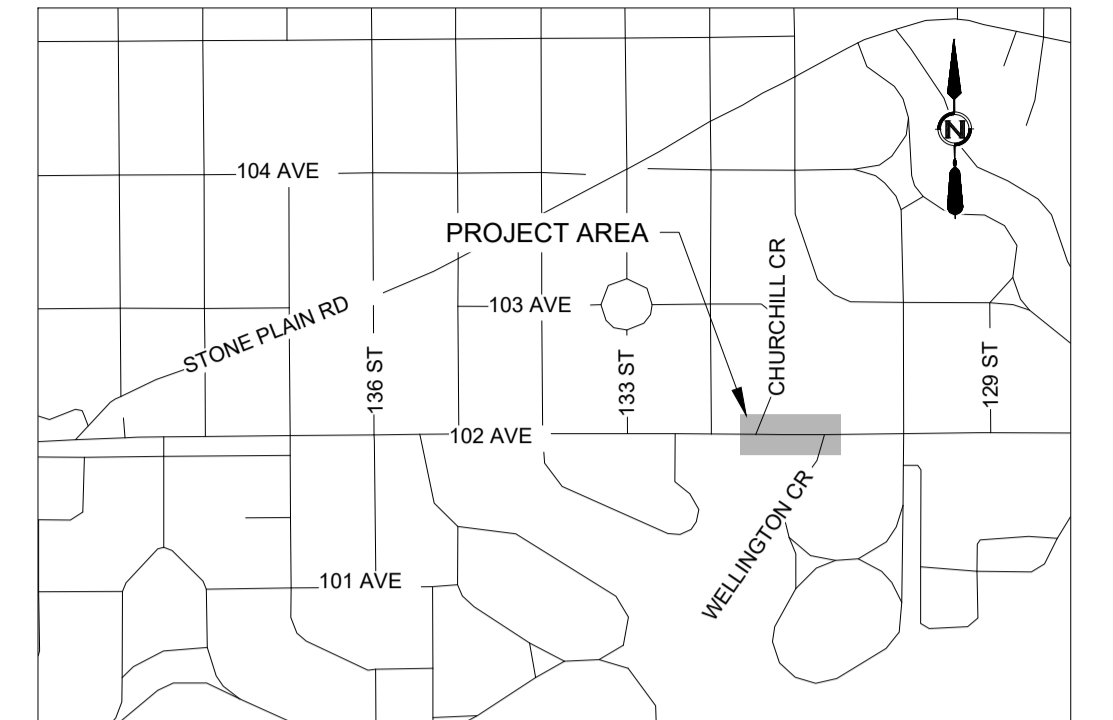
TRANSPORTATION INFRASTRUCTURE DELIVERY	DATE
SCALE	
SCALES SHOWN ARE CORRECT FOR FULL SIZE PLOTS (A1 SHEET SIZE)	
MANAGING CONSULTANT	

Edmonton INTEGRATED INFRASTRUCTURE SERVICES
INFRASTRUCTURE PLANNING AND DESIGN

WELLINGTON BRIDGE
131 STREET TO 132 STREET
PRELIMINARY REMOVALS PLAN

A102 P211 D01

DRAWN	B. COUTNEY	DATE	20MAY21
DESIGNED	J. MAREE	DATE	20MAY21
CHECKED	W. MCKAY	DATE	20MAY21



1 PLAN 1:250
102 AVENUE

LEGEND

- FULL REBUILD**
 60 mm 10 mm-HT ASPHALT
 100 mm 20 mm-B ASPHALT
 300 mm GRAVEL BASE
 150 mm CEMENT STABILIZED SUBGRADE
- CONCRETE**
- SODDING**
- 150 mm CURB AND 250 mm GUTTER**
- CONSTRUCTION LAYDOWN AREA**

SURFACE UTILITY LEGEND

○ TROLLEY POLES	□ TELEPHONE MANHOLE
○ WOODEN POWER POLE	○ TELEPHONE POLE
○ POWER POLE	○ DRAINAGE MANHOLE (SANITARY)
○ POWER POLE (SURVEYED)	○ DRAINAGE MANHOLE (STORM)
□ STREET LIGHT POLE	○ CATCH BASIN MANHOLE
○ STREET LIGHT POLE (SURVEYED)	○ CATCH BASIN
□ POWER MANHOLE	○ FIRE HYDRANT
→ POLE ANCHOR	○ FIRE HYDRANT (SURVEYED)
○ TRAFFIC POLE	○ WATER VALVE
○ TRAFFIC POLE (SURVEYED)	○ WATER TEE
□ TRAFFIC CABINET	○ ANODE
○ NEW LIGHTPOLE	□ ROADWAY SIGN

DETAIL NOTES

- ADJUST MANHOLES AND VALVES AS REQUIRED TO MATCH NEW PAVEMENT.
- ALL AREAS OF DISTURBANCE ADJACENT TO NEW CONSTRUCTION SHALL BE LANDSCAPED AS REQUIRED.
- LANDSCAPING OF ALL BOULEVARD AREAS TO MEET COMMUNITY SERVICES SPECIFICATIONS.
 - ALL SOD OVER 100 mm TOPSOIL.
 - ALL SEED OVER 150 mm TOPSOIL.
- ALL CURB AND GUTTER CONSTRUCTION TO BE 150 mm STANDARD CURB AND 250 mm GUTTER AS PER DRAWING 5000 OF COMPLETE STREETS DESIGN AND CONSTRUCTION STANDARDS, UNLESS OTHERWISE NOTED.
- A1 - CURB RAMP AS PER TYPE A1 ON DRAWING 5510 OF COMPLETE STREETS DESIGN AND CONSTRUCTION STANDARDS.
- A2 - CURB RAMP AS PER TYPE A2 ON DRAWING 5510 OF COMPLETE STREETS DESIGN AND CONSTRUCTION STANDARDS.
- B - CURB RAMP AS PER TYPE B ON DRAWING 5510 OF COMPLETE STREETS DESIGN AND CONSTRUCTION STANDARDS.
- C - CURB RAMP AS PER TYPE C ON DRAWING 5510 OF COMPLETE STREETS DESIGN AND CONSTRUCTION STANDARDS.
- THE PEDESTRIAN CROSSING TO BE CONSTRUCTED AS PER DRAWING 5215 OF COMPLETE STREETS DESIGN AND CONSTRUCTION STANDARDS.
- CONCRETE WALKS AND SHARED USE PATH AS PER DRAWING 5140 (WITH VARYING WIDTH) OF COMPLETE STREETS DESIGN AND CONSTRUCTION STANDARDS.
- STRUCTURAL ASPHALT OVERLAY REFERS TO THE DEPTH OF OVERLAY REQUIRED OVER THE EXISTING ASPHALT SURFACE (PRIOR TO COLD MILLING).
- REMOVE ALL LOOSE ASPHALT IN GUTTERS PRIOR TO OVERLAY.
- FOR ALL OVERLAYED GUTTERS, MAINTAIN A MINIMUM CURB HEIGHT OF 50 mm FOR BOULEVARD WALKS AND A MINIMUM CURB HEIGHT OF 75 mm FOR CURBLINE WALKS.
- ALL NEW MONOLITHIC SIDEWALKS TO BE 150 mm STRAIGHT FACE CURB AND 250 mm GUTTER, UNLESS OTHERWISE NOTED.
- REMOVE EXISTING CURB, GUTTER AND WALK AS REQUIRED.
- WHERE ASPHALT OVERLAY EXTENDS INTO EXISTING ACCESSES AND CURB RAMPS, ENSURE POSITIVE DRAINAGE TOWARDS ROADWAY.
- ALL TIES ARE TO LIP OF GUTTER (FOR CURB AND GUTTER CONSTRUCTION), TO CURB FACE (FOR SLAB-ON CONSTRUCTION) AND ALL LANE DIMENSIONS ARE TO CURB FACE, UNLESS OTHERWISE NOTED.
- FINAL LIMITS OF BASE REMOVAL, CURB REPLACEMENT AND GRINDING AT MATCH LOCATIONS TO BE FIELD DETERMINED.
- ALL GRINDING IS BASED ON EXISTING PAINT LINE CONFIGURATION, FOR NEW PAINT LINE CONFIGURATION SEE PAINT PLANS.
- NEW OVERLAY TO MATCH LIP OF GUTTER AT ALL NEW CURB RAMP LOCATIONS.
- SAW-CUT AREAS OF BASE REMOVAL.
- DEPRESS ALL NOSES ON NEW CONSTRUCTION.
- REPAIR ALL CRACKS PRIOR TO OVERLAY. ALL CRACKS GREATER THAN 25 mm IN WIDTH SHALL BE GROUND DOWN 50 mm X 1000 mm WIDE. IF CRACK IS NOT CLOSED THEN GRIND DOWN ANOTHER 75 mm X 600 mm WIDE THEN PREFILL AND OVERLAY.
- CATCH BASIN NOTES:
 - RELOCATE/ADJUST CATCH BASINS TO MATCH NEW ALIGNMENT/GRADES (AS REQUIRED).
 - IF NEW ASPHALT OVERLAY IS 50 mm OR LESS, WRAP ASPHALT TO MATCH EXISTING LIP OF GUTTER AT ALL CATCH BASINS.
 - IF NEW ASPHALT OVERLAY IS GREATER THAN 50 mm, RECONSTRUCT CURB, GUTTER AND CATCH BASINS TO MATCH OVERLAY REQUIREMENT.
 - REPLACE CATCH BASIN FRAMES AND COVERS AS REQUIRED (TO BE DETERMINED IN FIELD).

7	##	##	##	##
6	##	##	##	##
5	##	##	##	##
4	PRELIMINARY DESIGN - 99% SUBMISSION	WM	20MAY21	TA
3	PRELIMINARY DESIGN - 90% SUBMISSION	WM	01MAR21	TA
2	ISSUED FOR REVIEW	JJ	17 DEC 20	MK
1	ISSUED FOR REVIEW	JJ	4 DEC 20	CP
NO.	REVISIONS	BY	DATE	APPD

PROGRAM NO.	
CONTRACT NO.	
CONSTRUCTION RETURN	
CONTRACTOR	
SURVEYOR	
DATE	
FILE NUMBER	
CONSTRUCTION ENGINEER	DATE
GENERAL SUPERVISOR	DATE

DESIGN CONSULTANT

ASSOCIATED ENGINEERING

APPROVED FOR CONSTRUCTION	
DEPARTMENT / BRANCH	APPROVAL
	DATE

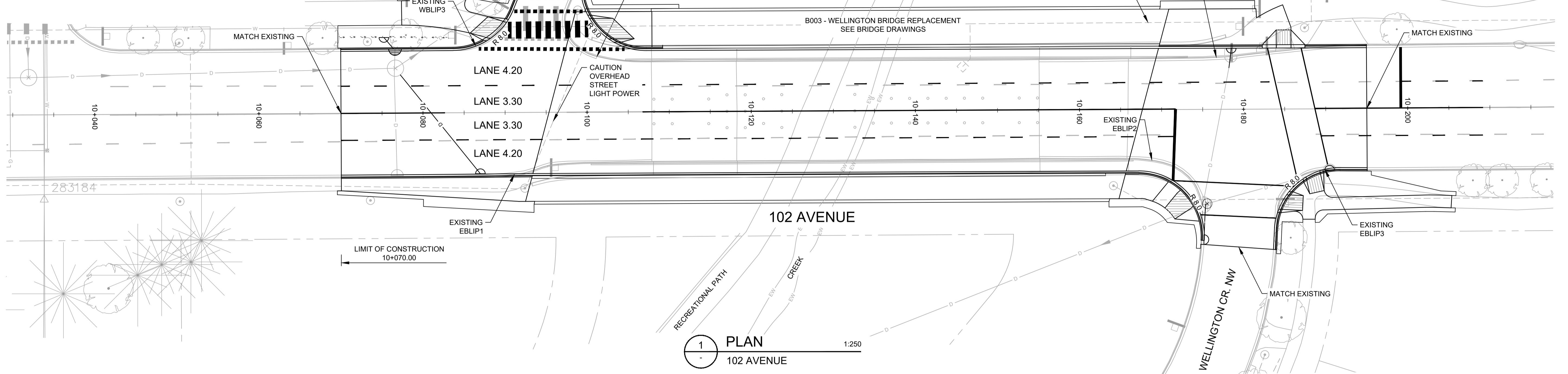
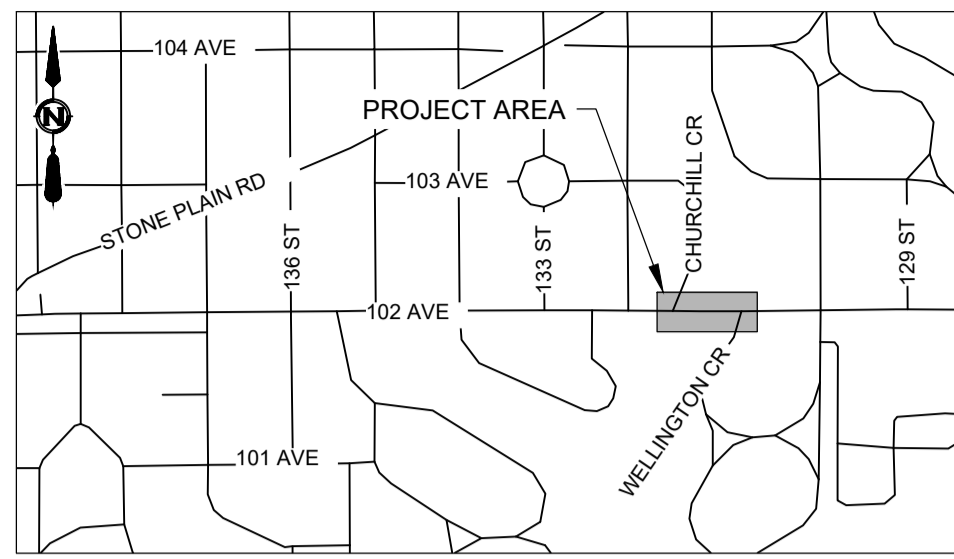
TRANSPORTATION INFRASTRUCTURE DELIVERY	DATE
SCALE	SCALES SHOWN ARE CORRECT FOR FULL SIZE PLOTS (AT SHEET SIZE)
MANAGING CONSULTANT	
TRANSPORTATION PLANNING AND DESIGN SUPERVISOR	
DEPARTMENT / BRANCH	APPROVAL
	DATE

DRAWN	J. MAREE	DATE	20MAY21
DESIGNED	J. MAREE	DATE	20MAY21
CHECKED	W. MCKAY	DATE	20MAY21

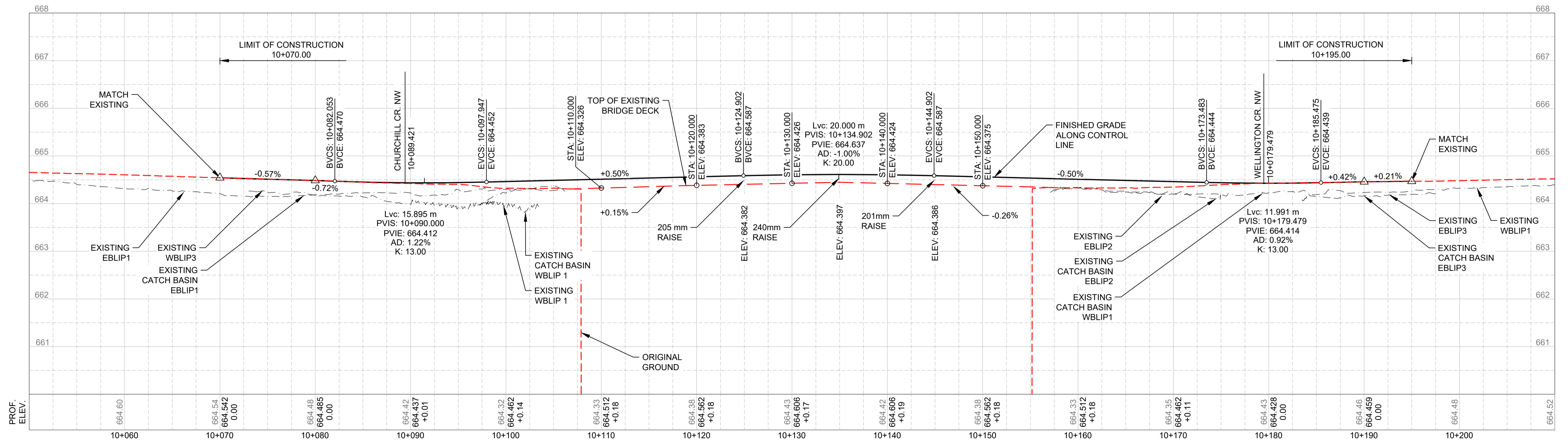
INTEGRATED INFRASTRUCTURE SERVICES
INFRASTRUCTURE PLANNING AND DESIGN

WELLINGTON BRIDGE
131 STREET TO 132 STREET
 PRELIMINARY NEW CONSTRUCTION PLAN

A102 P211 D02



1 PLAN
102 AVENUE
1:250

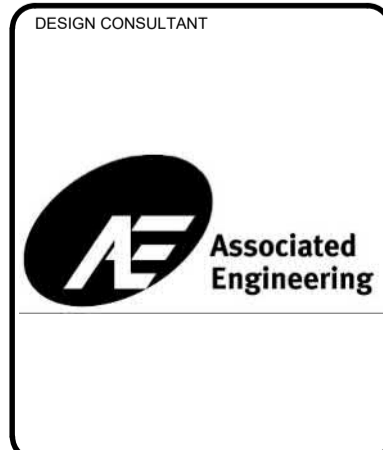


2 PROFILE
HZ 1:250, VT 1:25
102 AVENUE OVER WELLINGTON BRIDGE

NO.	REVISIONS	BY	DATE	APPD
7				
6				
5				
4	PRELIMINARY DESIGN - 99% SUBMISSION	WM	20MAY21	TA
3	PRELIMINARY DESIGN - 90% SUBMISSION	WM	01MAR21	TA
2	ISSUED FOR REVIEW	JJ	17 DEC 20	MK
1	ISSUED FOR REVIEW	JJ	4 DEC 20	CP

PROGRAM NO.			
CONTRACT NO.			
NO.	ISSUE	BY	DATE
4			
3			
2			
1			

CONTRACTOR	
SURVEYOR	
DATE	
FILE NUMBER	
CONSTRUCTION ENGINEER	DATE
GENERAL SUPERVISOR	DATE



APPROVED FOR CONSTRUCTION

TRANSPORTATION PLANNING AND DESIGN SUPERVISOR

DEPARTMENT / BRANCH	APPROVAL	DATE

TRANSPORTATION INFRASTRUCTURE DELIVERY	DATE
SCALE AS SHOWN	
SCALES SHOWN ARE CORRECT FOR FULL SIZE PLOTS (A1 SHEET SIZE)	
MANAGING CONSULTANT	
CHECKED	DATE
W. MCKAY	20MAY21

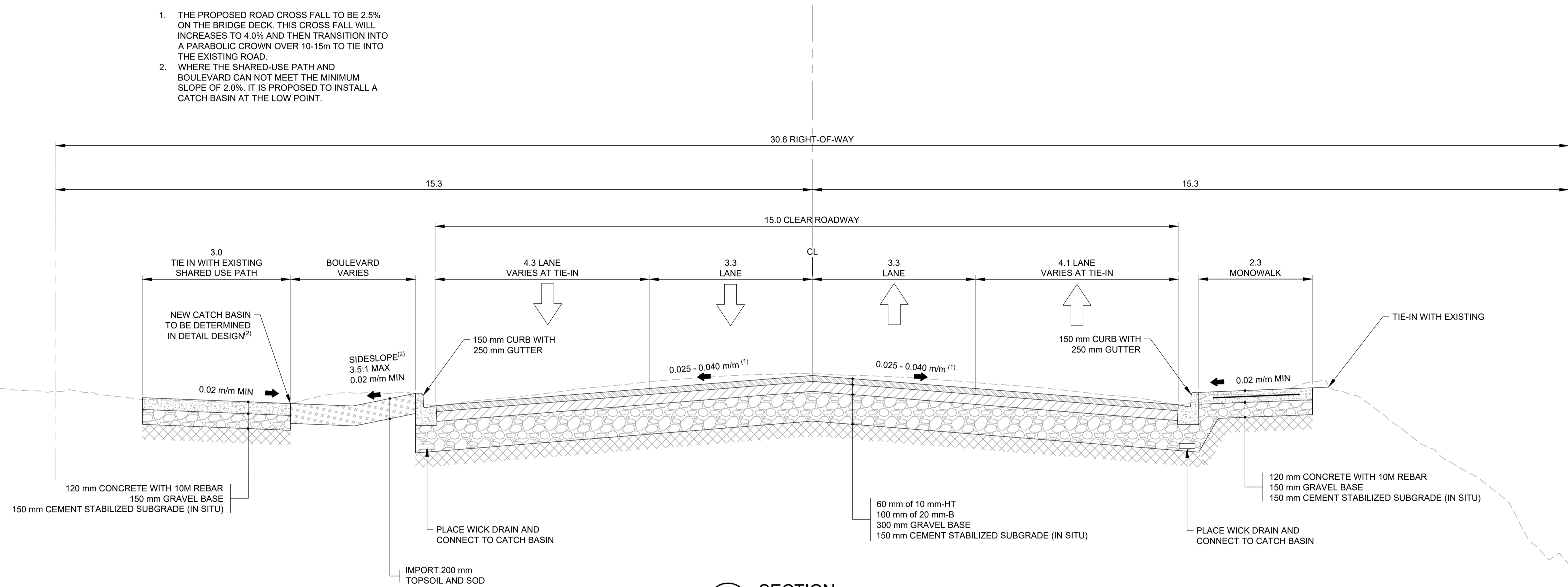
Edmonton INTEGRATED INFRASTRUCTURE SERVICES
INFRASTRUCTURE PLANNING AND DESIGN

WELLINGTON BRIDGE
131 STREET TO 132 STREET
PRELIMINARY PLAN AND PROFILE

A102 P211 G01

NOTES:

1. THE PROPOSED ROAD CROSS FALL TO BE 2.5% ON THE BRIDGE DECK. THIS CROSS FALL WILL INCREASE TO 4.0% AND THEN TRANSITION INTO A PARABOLIC CROWN OVER 10-15m TO TIE INTO THE EXISTING ROAD.
2. WHERE THE SHARED-USE PATH AND BOULEVARD CAN NOT MEET THE MINIMUM SLOPE OF 2.0%. IT IS PROPOSED TO INSTALL A CATCH BASIN AT THE LOW POINT.

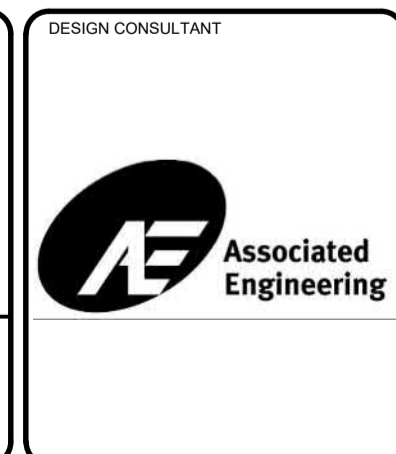


1 SECTION
 D02 TYPICAL CROSS SECTION FOR RECONSTRUCTION OF 131 STREET
 1:50 H 1:25 V

7	##	##	##	##
6	##	##	##	##
5	##	##	##	##
4	PRELIMINARY DESIGN - 99% SUBMISSION	WM	20 MAY 21	TA
3	PRELIMINARY DESIGN - 90% SUBMISSION	WM	01 MAR 21	TA
2	ISSUED FOR REVIEW	JJ	17 DEC 20	MK
1	ISSUED FOR REVIEW	JJ	4 DEC 20	CP
NO.	REVISIONS	BY	DATE	APPD

PROGRAM NO.	
CONTRACT NO.	
NO.	ISSUE BY DATE

CONSTRUCTION RETURN	
CONTRACTOR	
SURVEYOR	
DATE	
FILE NUMBER	
CONSTRUCTION ENGINEER	DATE
GENERAL SUPERVISOR	DATE



APPROVED FOR CONSTRUCTION	

TRANSPORTATION PLANNING AND DESIGN SUPERVISOR	
DEPARTMENT / BRANCH	APPROVAL DATE

TRANSPORTATION INFRASTRUCTURE DELIVERY	DATE
SCALE	SCALES SHOWN ARE CORRECT FOR FULL SIZE PLOTS (AT SHEET SIZE)
MANAGING CONSULTANT	
DRAWN	J. MAREE 20MAY21
DESIGNED	J. MAREE 20MAY21
CHECKED	W. MCKAY 20MAY21


INTEGRATED INFRASTRUCTURE SERVICES
 INFRASTRUCTURE PLANNING AND DESIGN

WELLINGTON BRIDGE
131 STREET TO 132 STREET
 PRELIMINARY TYPICAL CROSS SECTION

A102 P211 X01

APPENDIX D - CROWN CLAIM INQUIRY COMMUNICATIONS



April 23, 2021
File: 2020-3858

Provincial Water Boundaries Unit
Provincial Programs Branch
Operations Division
Alberta Environment and Parks
2nd Floor, 9915 - 108 Street
Petroleum Plaza, South Tower
Edmonton, AB, T5K 2G8
Submitted via email: water.boundaries@gov.ab.ca

Re: WATER BODY FEATURE OWNERSHIP INQUIRY

To whom it may concern:

It is our understanding that the Crown owns the bed and shore of naturally occurring rivers and streams whereas undefined and ephemeral watercourses are not owned by the Crown as they do not have a channel or bed and shore (*Public Lands Act* (R.S.A. 2000, c. P-40)). The ownership of a body of water is not always obvious and verification of ownership may be required.

Wellington Bridge ("the Bridge") is located along 102 Avenue in Edmonton, Alberta. The Bridge is approaching the end of its service life and requires replacement. An unnamed water body occurs beneath the Bridge (GOA 2021) and it is unknown if this water body is owned by the Crown. It is our objective to clarify the ownership of this unnamed water body and determine applicable regulations to be followed as part of the proposed Bridge replacement project.

Please accept this letter as a request for a water boundary ownership review for one unnamed water body (Water body ID: 44445) located in the SE-1-53-25-W4M and the NE-36-62-25-W4M of Edmonton, Alberta (**Figure 1-1**). Unnamed Waterbody 44445 is a tributary to the North Saskatchewan River (Water body ID: 2162) (GOA 2021).

The following documents are included or attached to this letter to facilitate the review.

1. **Summary report of the field assessment completed**
 - a. Section 1 below
2. **Representative site photographs from the assessment**
 - a. Site photographs (**Appendix A**)
3. **Assessment table**
 - a. Summary of water body characteristics



1 SUMMARY OF ASSESSMENT

1.1 ASSESSMENT METHODS

An assessment of the watercourse was completed by Portia Lloyd (P.Biol.) on April 8, 2021 following methodologies outlined in the Roadway Watercourse Crossing Inspection Manual (GoA 2015) and the Guide to the Code of Practice for Watercourse Crossings (AE 2001).

1.2 ASSESSMENT RESULTS

Unnamed Water body 44445 ("the watercourse") is located at the bottom of Ramsey Ravine where it flows south under Wellington Bridge (102 Avenue) and then outlets into the North Saskatchewan River (**Figure 1-1**). Ramsey Ravine is a recreational area with paved and unpaved pathways surrounded by a mature mixed wood forest. A summary of transects and data collected during the field assessment is provided in **Table 1-1**.

Between Transects T1 and T3 (**Figure 1-1**) the watercourse is a small permanent feature with well-defined bed and bank, an average channel width of 2.57 m and pools and riffles present at regular spacing. At Transect T3 the watercourse converges with a second unnamed watercourse (water body ID: 44466, **Figure 1-1**). At Transect T4 the watercourse becomes impassable to fish species due to rip rap placement along the south facing slope of a paved trail. Overland flow and seepage through the rip rap come from the remaining portion of the watercourse upstream of this location.

Between Transects T4 and T7 the watercourse varies between a transitional and an ephemeral feature. The transitional sections of the watercourse had an average channel width of 0.60 m and substrate dominated by fines. The intermittent portion of the watercourse lacks terrestrial vegetation, has an average channel width of 0.40 m or less and substrate that is dominated by fines. The intermittent portion of the watercourse (**Figure 1-1**) has been heavily modified by recreational activities, including mountain biking, and hiking. The ephemeral portions of the watercourse lack a defined channel, has little to no water flow, contains vegetated organic bridges and has a substrate that is dominated by fines.

Ramsey Ravine is heavily influenced by anthropogenic activities. Under the Bridge the watercourse passes through a culvert and each end of the culvert is reinforced with rip rap. A minimum of ten outfall structures are connected to the watercourse, directing stormwater runoff from the surrounding residential areas into the watercourse. Stormwater inputs increase as the watercourse continues towards the North Saskatchewan River. This correlates with the change in permanence of the watercourse suggesting that increased anthropogenic activities contribute to the change in watercourse type (ephemeral to small permanent).



Table 1-1
Transects completed for Unnamed Watercourse (Waterbody ID 44445)

Transect No.	Channel Width	Bankfull Width	Water Depth (Average)	Substrate	Bank Height (Average)	Permanence	Photos (Appendix A)
T1	3.00 m	1.50 m	0.13 m	50% large boulder, 50% fines	1.00 m	Small Permanent	Photos 1 - 4
T2	3.20 m	1.25 m	0.15 m	50% large boulder, 10% cobble, 10% large gravel, 30% fines	1.10 m	Small Permanent	Photos 5 - 8
T3	4.50 m	1.25 m	0.10 m	90% fines, 10% gravel	1.75 m	Small Permanent	Photos 9 - 11
T4	0.60 m	0.30 m	0.05 m	100% fines	0.50 m	Transitional	Photos 12 - 15
T5	-	4.00 m	0.05 m	100 % fines	-	Ephemeral	Photos 16 - 18
T6	0.40 m	0.25 m	0.05 m	100 % fines	0.30 m	Intermittent	Photos 19 - 21
T7	-	0.00 m	0.00 m	100 % fines	-	Ephemeral	Photos 22 - 24

2 CONCLUSIONS

Unnamed water body 44445 begins as an alternating ephemeral – intermittent feature (T7 to T5) that passes through a culvert under the Bridge. The intermittent portion of the upstream reach is likely a result of modification of the watercourse caused by recreational activities. A barrier to fish passage occurs at Transect T4, located south of the Bridge. The confluence of unnamed water body 44445 and 44466 occurs at Transect T3. Downstream of Transect T3 the water body changes from transitional to small-permanent as increased surface water runoff is directed towards the channel from the surrounding area via a series of outfall structures ([Figure 1-1](#)).

Determining the overall watercourse classification is challenging because of the many physical features of the watercourse that have been modified. It is our understanding that in the event of an apparent difference in stream features between the upstream and downstream side of a crossing, the classification should be based on the upstream features. In this case, it would result in the unnamed watercourse 44445 being classified as an ephemeral feature.



3 CLOSURE

We trust this letter and its attachments provide you with the information necessary to review Crown ownership status. Please indicate whether or not the Crown owns the entirety of the mapped unnamed watercourse (Water body ID: 44445) or if only a portion of the watercourse is Crown owned.

Any questions can be directed to the undersigned at 587-599-7662.

Prepared by:

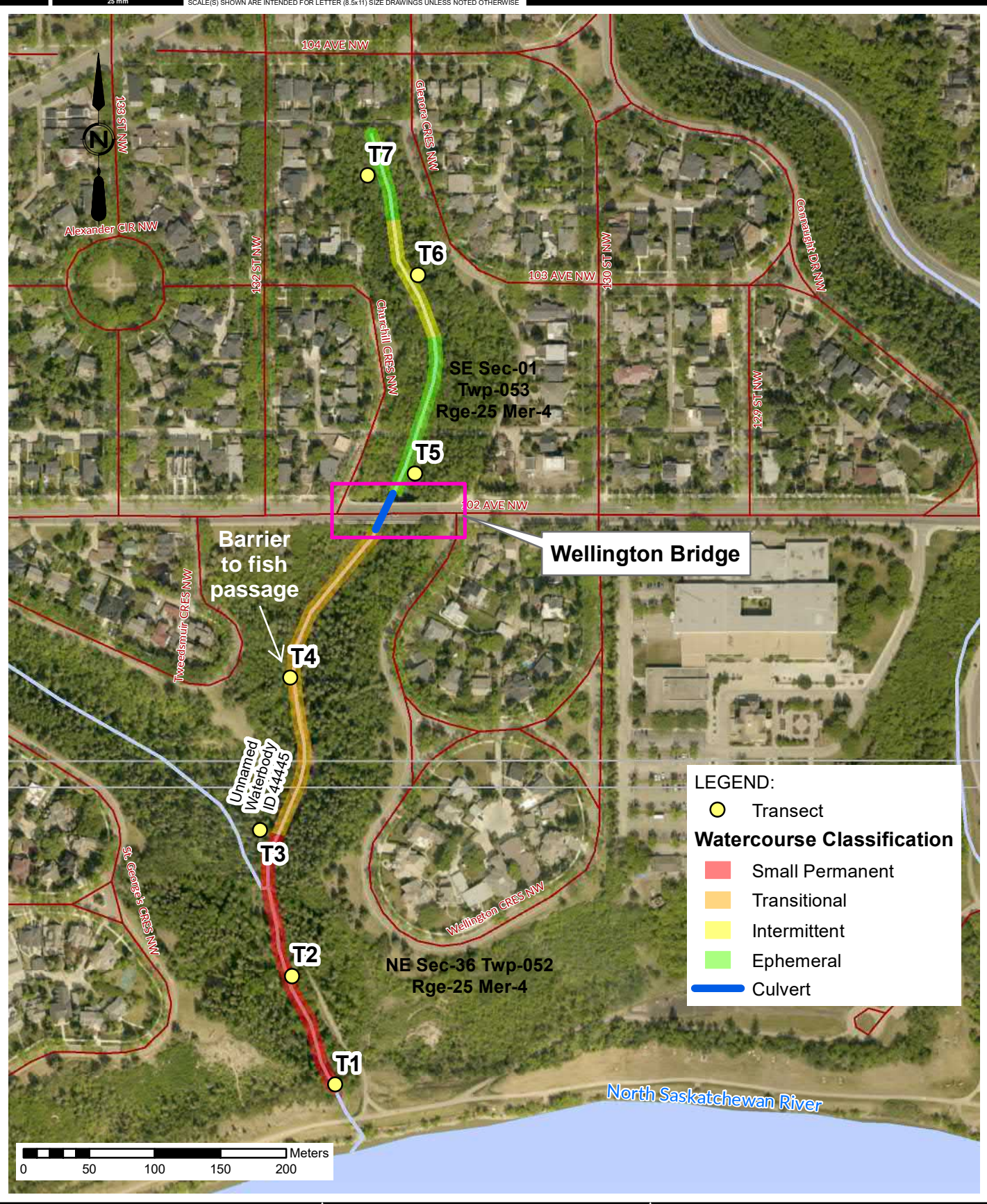
A handwritten signature in blue ink, appearing to read 'Portia Lloyd'.

Portia Lloyd, P.Biol.
Environmental Scientist

PL

Attachments:

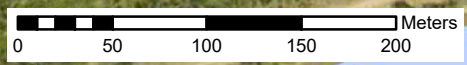
- Overview of the watercourse assessed for determination of Crown Ownership (**Figure 1-1**)
- References
- Site Photographs (**Appendix A**)



SAVE DATE: 4/22/2021 1:57:45 PM. SAVED BY: [Name]
 DRAWING PATH: [Path]
 DATA SOURCE: [Source]

LEGEND:

- Transect
- Watercourse Classification**
- █ Small Permanent
- █ Transitional
- █ Intermittent
- █ Ephemeral
- █ Culvert



AE PROJECT No.	2020-3858-00
SCALE	1:4,000
APPROVED	
DATE	2021 APR 22
REV	
DESCRIPTION	ISSUED FOR REPORT

FIGURE 1-1

CITY OF EDMONTON
 WELLINGTON BRIDGE REPLACEMENT

ENVIRONMENT
 CROWN OWNERSHIP ASSESSMENT



REFERENCES

Government of Alberta (GoA). 2021. Fish and Wildlife Internet Mapping Tool (FWIMT). Accessed online April 12, 2021 at: <https://www.alberta.ca/access-fwmis-data.aspx>

Government of Alberta (GoA). 2015. Roadway Watercourse Crossing Inspection Manual. Accessed online April 12, 2021 at: <https://open.alberta.ca/dataset/a832eee1-53b4-45f7-a46c-8e81b498080f/resource/d338eb1d-5609-4a3a-bc96-e876442df0c4/download/6799953-2015-roadway-watercourse-crossing-inspection-manual-version-5.2.2.-2015-03-13.pdf>

Alberta Environment (AE). 2001. Guide to the Code of Practice for Watercourse Crossings, Including Guidelines for Complying with the Code of Practice. Accessed online April 12, 2021 at: <https://open.alberta.ca/dataset/7f60e27f-d9ca-4215-aaae-9adec610974b/resource/f1dfd81c-4bb9-4ff7-a547-4d702870d32c/download/2001-watercoursecrossingsguide-apr2001.pdf>



APPENDIX A: SITE PHOTOGRAPHS



Photograph 1
Upstream showing channel at Transect T1.



Photograph 2
Downstream showing channel and outfall structure at Transect T1.



Photograph 3

Left bank showing representative conditions and mixed woody vegetation.



Photograph 4

Showing channel and substrate as a mix of large boulder and fines.



Photograph 5
Upstream showing channel at Transect T2.



Photograph 6
Downstream showing channel at Transect T2.



Photograph 7

Left bank showing representative conditions, mixed woody riparian vegetation, slumping and evidence of erosion.



Photograph 8

Showing channel and substrate as a mix of large boulder, cobble, gravel, and fines.



Photograph 9
Upstream showing channel for unnamed watercourse (Waterbody ID: 44445) and evidence of erosion at Transect T3.



Photograph 10
Upstream showing channel for unnamed watercourse (Waterbody ID: 44466) at confluence with unnamed watercourse (Waterbody ID: 44445).



Photograph 11

Downstream of channel at confluence of unnamed waterbodies (Waterbody ID's: 44445 and 44466).



Photograph 12

Upstream showing less defined channel at Transect T4.



Photograph 13

Downstream of channel at Transect T4 showing significant decrease in channel size and permanence.



Photograph 14

Showing the channel substrate at Transect T4 and reduced flow.



Photograph 15

Showing representative bank conditions with mixed wood riparian vegetation at Transect T4.



Photograph 15

Culvert located under Wellington Bridge on the upstream side near Transect T5.



Photograph 16

Showing upstream conditions of vegetated ephemeral drainage at Transect T5.



Photograph 17

Showing downstream ephemeral drainage flowing towards Wellington Bridge at Transect T5.



Photograph 18

Showing ephemeral drainage at Transect T5 and pooling water. No flow was visible at this location.



Photograph 19

Showing upstream channel at Transect T6.



Photograph 20
Showing downstream channel at Transect T6.



Photograph 21
Showing channel and substrate at Transect T6.



Photograph 22

Upstream showing modified channel caused by recreational activities in the intermittent zone of the watercourse.



Photograph 22

Upstream showing origin of unnamed waterbody (Waterbody ID: 44445) at Transect T7.



Photograph 23
Downstream showing ephemeral drainage at Transect T7.



Photograph 24
Showing representative vegetation on either side of the ephemeral drainage of the unnamed watercourse and pathways caused by recreational activities (Waterbody ID: 44445) at Transect T7.

Brett Bodeux

From: AEP Water-Boundaries <Water.Boundaries@gov.ab.ca>
Sent: Tuesday, July 20, 2021 4:54 PM
To: Portia Lloyd
Cc: Brett Bodeux; Chris Pyra; Tara Alexander; Suzanne Card; Kristen Andersen
Subject: RE: Crown Ownership Determination Request - Wellington Bridge

Hello Portia,

Thank you for your enquiry and your patience. I was unable to locate any record at the Water Boundaries Unit showing a previous ownership assessment of the bed and shore of the subject creek (called Wellington Creek). However, existing active DLO 1384 and 1385 at approximate location of the confluence of the two watercourses (near Transect T3 as shown in Figure 1-1 of your report) suggest that the bed and shore of Wellington Creek had previously been acknowledged to be owned by the Crown in right of Alberta. Additionally, a review of historical grants and titles for Lot 2, Plan of Edmonton Settlement does not show any bed and shore to be specifically included in the originally granted land at that location. Also, the current title to Block I, Plan 2804AF (where Wellington Creek is located) is silent about the existence of any bed and shore in that area. Therefore, the Crown ownership claim to the bed and shore of this creek will only rely on Section 3 of the *Public Lands Act*. accordingly, the portion of Wellington Creek from North Saskatchewan River towards upstream up to where it shows a discernible and continuous bed will meet the criteria of a permanent watercourse and will be eligible for a Crown ownership claim under Section 3 of the *Public Lands Act*.

It should be mentioned that water does not have to be uninterruptedly flowing within a drainage channel all year round to be considered as a permanent watercourse. As long as the regular flow of water marks a discernible and continuous bed within that channel, that defined and continuous bed would be the evidence for the permanence of that watercourse.

Please let me know if any additional clarification is required and/or you have any questions or comments on this matter.

Regards,

Sid

Sid Parseyan, M.Sc.

Senior Water Boundary Analyst
Water Boundaries Unit
Grants and Program Delivery Section
Lands Policy and Programs Branch
Lands Division
2nd Floor, South Petroleum Plaza
9915 – 108 Street, Edmonton, AB T5K 2G8
Phone: (780) 422-0187 | Fax: (780) 422-3120
Email: sid.parseyan@gov.ab.ca



Please consider your environmental responsibility before printing this e-mail

Classification: Protected A

From: Portia Lloyd <lloyd@ae.ca>

Sent: April-23-21 10:14 AM

To: AEP Water-Boundaries <Water.Boundaries@gov.ab.ca>

Cc: Brett Bodeux <bodeuxb@ae.ca>; Chris Pyra <pyrac@ae.ca>; Tara Alexander <alexandert@ae.ca>; Suzanne Card <cards@ae.ca>; Kristen Andersen <andersenk@ae.ca>

Subject: Crown Ownership Determination Request - Wellington Bridge

CAUTION: This email has been sent from an external source. Treat hyperlinks and attachments in this email with care.

Good Morning,

Please find attached a letter including current site photos, a summary of field findings to request the determination of Crown ownership for unnamed watercourse (water body ID: 44445) located in Edmonton, Alberta.

Please let me know if there are any questions.

Thank you kindly for your time.

Portia Lloyd, P.Biol.

Environmental Scientist

Associated Environmental Consultants Inc.

500, 9888 Jasper Avenue, Edmonton, AB T5J 5C6

Tel: 780.451.7666 | Cel: 587.599.7662 | Dir: 587.686.6672



Associated
Environmental



CANADIAN
BEST
MANAGED
COMPANIES

For the health and safety of our staff, clients and communities, our offices remain closed until further notice.

During this period, staff will be working remotely and are available to meet our clients' requirements. Your projects are our priority. If you have any questions or concerns, please contact me.

You may [unsubscribe from Associated's electronic communications](#) at any time.

Brett Bodeux

From: AEP Water-Boundaries <Water.Boundaries@gov.ab.ca>
Sent: Tuesday, August 24, 2021 8:56 AM
To: Portia Lloyd
Cc: Brett Bodeux
Subject: RE: Crown Ownership Determination Request - Wellington Bridge

Good morning Portia,

As it is mentioned in my linked email below, it is clear that the bed and shore of this creek was deemed to be eligible for a Crown ownership claim under Section 3 of the *Public Lands Act*. The only uncertainty is the length of the Crown-owned bed and shore. As determining the ownership boundaries is a practice of land surveying which is regulated by legislation in Alberta, an Alberta Land Surveyor is an authorized person to officially determine in the field that how far the bed and shore of this creek extends towards upstream. However, if the discernible bed of this creek continuously is traceable to the project location, it means that the Crown-owned bed and shore extends to the project area.

Hope the above explanations clarify the matter for you. Please let me know if you have any further questions or comments in this regard.

Regards,

Sid

Sid Parseyan, M.Sc.

Senior Water Boundary Analyst
Water Boundaries Unit
Grants and Program Delivery Section
Lands Policy and Programs Branch
Lands Division
2nd Floor, South Petroleum Plaza
9915 – 108 Street, Edmonton, AB T5K 2G8
Phone: (780) 422-0187 | Fax: (780) 422-3120
Email: sid.parseyan@gov.ab.ca



Please consider your environmental responsibility before printing this e-mail

Classification: Protected A

From: Portia Lloyd <lloydp@ae.ca>
Sent: August-23-21 4:42 PM
To: AEP Water-Boundaries <Water.Boundaries@gov.ab.ca>
Cc: Brett Bodeux <bodeuxb@ae.ca>
Subject: RE: Crown Ownership Determination Request - Wellington Bridge

CAUTION: This email has been sent from an external source. Treat hyperlinks and attachments in this email with care.

Hi Sid,

Thank you for response to our inquiry.

For clarification, can you please confirm the following:

1. There is uncertainty regarding the Crown ownership of Wellington Creek at the project location, which is upstream of the two previous DLO's.
2. If there is a discernible and continuous bed within Wellington Creek at this location then it would be eligible for a Crown ownership claim pursuant with the *Public Lands Act*.

Regards,

Portia Lloyd, P.Biol.
Environmental Scientist
Associated Environmental Consultants Inc.
500, 9888 Jasper Avenue, Edmonton, AB T5J 5C6
Tel: 780.451.7666 | Cel: 587.599.7662 | Dir: 587.686.6672



Associated
Environmental



As COVID-19 restrictions begin to ease, our staff are working both from the office and remotely. Your projects remain our priority, and we will continue to be available to meet your requirements. Please contact me with any questions or concerns.

From: AEP Water-Boundaries <Water.Boundaries@gov.ab.ca>
Sent: Tuesday, July 20, 2021 4:54 PM
To: Portia Lloyd <lloyd@ae.ca>
Cc: Brett Bodeux <bodeux@ae.ca>; Chris Pyra <pyrac@ae.ca>; Tara Alexander <alexandert@ae.ca>; Suzanne Card <cards@ae.ca>; Kristen Andersen <andersenk@ae.ca>
Subject: RE: Crown Ownership Determination Request - Wellington Bridge

Hello Portia,

Thank you for your enquiry and your patience. I was unable to locate any record at the Water Boundaries Unit showing a previous ownership assessment of the bed and shore of the subject creek (called Wellington Creek). However, existing active DLO 1384 and 1385 at approximate location of the confluence of the two watercourses (near Transect T3 as shown in Figure 1-1 of your report) suggest that the bed and shore of Wellington Creek had previously been acknowledged to be owned by the Crown in right of Alberta. Additionally, a review of historical grants and titles for Lot 2, Plan of Edmonton Settlement does not show any bed and shore to be specifically included in the originally granted land at that location. Also, the current title to Block I, Plan 2804AF (where Wellington Creek is located) is silent about the existence of any bed and shore in that area. Therefore, the Crown ownership claim to the bed and shore of this creek will only rely on Section 3 of the *Public Lands Act*. accordingly, the portion of Wellington Creek from North Saskatchewan River towards upstream up to where it shows a discernible and continuous bed will meet the criteria of a permanent watercourse and will be eligible for a Crown ownership claim under Section 3 of the *Public Lands Act*.

It should be mentioned that water does not have to be uninterruptedly flowing within a drainage channel all year round to be considered as a permanent watercourse. As long as the regular flow of water marks a discernible and continuous bed within that channel, that defined and continuous bed would be the evidence for the permanence of that watercourse.

Please let me know if any additional clarification is required and/or you have any questions or comments on this matter.

Regards,

Sid

Sid Parseyan, M.Sc.

Senior Water Boundary Analyst
Water Boundaries Unit
Grants and Program Delivery Section
Lands Policy and Programs Branch
Lands Division
2nd Floor, South Petroleum Plaza
9915 – 108 Street, Edmonton, AB T5K 2G8
Phone: (780) 422-0187 | Fax: (780) 422-3120
Email: sid.parseyan@gov.ab.ca



Please consider your environmental responsibility before printing this e-mail

Classification: Protected A

From: Portia Lloyd <lloydp@ae.ca>

Sent: April-23-21 10:14 AM

To: AEP Water-Boundaries <Water.Boundaries@gov.ab.ca>

Cc: Brett Bodeux <bodeuxb@ae.ca>; Chris Pyra <pyrac@ae.ca>; Tara Alexander <alexandert@ae.ca>; Suzanne Card <cards@ae.ca>; Kristen Andersen <andersenk@ae.ca>

Subject: Crown Ownership Determination Request - Wellington Bridge

CAUTION: This email has been sent from an external source. Treat hyperlinks and attachments in this email with care.

Good Morning,

Please find attached a letter including current site photos, a summary of field findings to request the determination of Crown ownership for unnamed watercourse (water body ID: 44445) located in Edmonton, Alberta.

Please let me know if there are any questions.

Thank you kindly for your time.

Portia Lloyd, P.Biol.

Environmental Scientist

Associated Environmental Consultants Inc.

500, 9888 Jasper Avenue, Edmonton, AB T5J 5C6

Tel: 780.451.7666 | Cel: 587.599.7662 | Dir: 587.686.6672



Associated
Environmental



BEST
MANAGED
COMPANIES

For the
Future

For the health and safety of our staff, clients and communities, our offices remain closed until further notice.

During this period, staff will be working remotely and are available to meet our clients' requirements. Your projects are our priority. If you have any questions or concerns, please contact me.

You may [unsubscribe from Associated's electronic communications](#) at any time.

You may [unsubscribe from Associated's electronic communications](#) at any time.

APPENDIX E - PROJECT ENGAGEMENT COMMUNICATION PLAN

Wellington Bridge Replacement

Transportation Planning and Design

Integrated Infrastructure Services | Infrastructure Planning & Design

Section A: Engagement/Communications Strategy

Section B: Engagement/Communications Activities

Section C: Review and Approval

Section D: Tracking Changes

Section E: Commitment Tracking

A: Engagement/Communications Strategy

A.1 Background and Context

The Wellington Bridge, located on 102 Avenue between Churchill Crescent and Wellington Crescent, has been slated for replacement as it is reaching the end of its service life. The bridge is currently funded through construction. The preliminary design for this bridge has started and is anticipated to be completed in spring 2021. Detailed design will follow and construction will be completed in coordination with Valley Line West LRT construction on Stony Plain Road. Construction is anticipated to start between 2025 and 2028.

The Wellington Bridge was originally constructed in 1932 and serves as an arterial roadway with four lanes of traffic, and a sidewalk on each side of the bridge. It is a major link between Edmonton's city centre and communities to the west. The bridge crosses Ramsey Ravine which features a shared use pathway connecting the community of Glenora to the river valley. The bridge is also part of West Central Bike Routes' 102 Avenue Shared Use Pathway (SUP).

Public engagement occurred in 2016 on the SUP. Neighbourhood Renewal occurred in approximately 2012 and the community was extremely interested and influential in the process and ultimate design.

The Wellington Bridge is a highly regarded historic landmark in the community. It is listed in the Register of Historic Resources in Edmonton and Alberta Historic Resources Management Branch. Two of its historic features were identified as being important by the City of Edmonton Heritage Planner: the

concrete railings and concrete arches. These components of the bridge may be considered for re-use on the new bridge, or reinterpreted in the new design.

The West Valley Line LRT, currently under procurement, will impact the Wellington Bridge construction timing and level of use. The LRT construction, from downtown to Lewis Farms, is anticipated in 2021 through 2027 and will impact the level of service on Stony Plain Road/104 Avenue. The Stony Plain Road Bridge over Groat Road will be replaced as part of the LRT project with an anticipated construction timeline of three years.

Policies and plans will provide direction for this project. These include, but are not limited to:

- The City Plan (Draft)
- The Way We Move (Transportation Master Plan)
- Edmonton Bike Plan
- Bus Network Redesign
- Breathe
- Policy C593 – Public Engagement Policy

A.2 Role of the Public

The City of Edmonton has determined that this project will have minimal opportunity for public engagement as this is a project to replace Wellington Bridge and is focused on function and budget.

As determined in the decision mapping, this project will consist primarily of key stakeholder engagement along with information sharing and communications to both stakeholders and the public. . Feedback on detours and other construction impacts will be at the ADVISE level. The Old Glenora Conservation Association and the Glenora Community League have been identified as having a high level of influence and interest in this project and may require discussions early in the process.

A.3 Public Input (Information) Needed for Decision Making

Public Input (Information) Needed	Description
<ul style="list-style-type: none"> ● General community information as to how the community operates from a multi-modal perspective 	<ul style="list-style-type: none"> ● Traffic flow, outdoor activities that may be impacted such as trails, crossing, accesses
<ul style="list-style-type: none"> ● What construction impacts need to be addressed? 	<ul style="list-style-type: none"> ● Detours for pedestrians, vehicles and cyclists
<ul style="list-style-type: none"> ● How best to provide project information to the community? 	<ul style="list-style-type: none"> ● Best methods of delivering information during design and construction to stakeholders

A.4 Decision Mapping

[Decision Mapping link](#)

A.5 Communication, Decision Making and Public Engagement

*Project Phase 1A Pre-Engagement	
<p>Communication:</p> <ul style="list-style-type: none"> ● Webpage ● Intro emails to identified stakeholders, such as 124 Street BIA, Old Glenora Conservation Association and Glenora Community League ● 311 to inform about geotechnical drilling in ravine and ends of bridge ● Signage on trail about geotechnical drilling in ravine and ends of bridge (by contractor) 	<p>Project introduction: project history, scope of work, and timeline and PM contact information</p>
<p>Decision:</p> <ul style="list-style-type: none"> ● What bridge design will meet the budget, and standards, as well as provide a suitable level of aesthetics to meet community aspirations? ● Will portions of the existing bridge be retained and/or be reused? ● Will public art be a component of this bridge? 	<p>Technical/internal decisions only</p>
<p>Decision Maker:</p>	<p>Project Manager/Project Team</p>
<p>Role of the Public:</p>	<p>NA</p>
<p>Communications Objectives:</p>	<p>Inform the public that the project has started and keep them updated on the status. Inform about geotechnical drilling in ravine below bridge requiring temporary trail closures</p>
<p>Follow-up Communication:</p>	<p>NA</p>

*Project Phase 1B Preliminary Design:

<p>Communication:</p> <ul style="list-style-type: none"> • Event invitation to Glenora/Grsovenor residents • Webpage update, email/letter to identified stakeholders such as 124 Street Business Association, businesses. • Potential one-on-ones with identified stakeholders about use, construction impacts, etc. This may include businesses in the High Street area.. • Potential event/information package (online or in-person or mailout dependent on COVID-19 requirements) 	<p>What has been decided in preliiminary design (i.e. bridge type, public art inclusion, retain/reuse existing bridge elements, schedule update, etc.)</p>
<p>Decision:</p> <ul style="list-style-type: none"> • What will construction impacts be and how may they be addressed? • Potential question for Glenora stakeholders: What does your ideal experience of the future Wellington Bridge feel like? 	<p>Mainly technical decisions. Stakeholders will advise on construction impacts and how they may be addressed. Stakeholders may advise on the preferred experience of the new bridge.</p>
<p>Decision Maker:</p>	<p>Project Manager</p>
<p>Role of the Public:</p>	<p>NA</p>
<p>Stakeholder Engagement Objectives:</p>	<p>Information sharing and ADVISE (w/ key stakeholders)</p>
<p>StakeholderEngagement Commitment by Decision Makers:</p>	<p>Inform the public on the project status and any relevant decisions. Consider information on impacts, adjust design, if possible, and address concerns</p>
<p>Post-Engagement Communication:</p>	<p>Respond to stakeholder concerns with meeting summaries</p>

***Project Phase 2 Detailed Design:**

<p>Communication:</p> <ul style="list-style-type: none"> • Webpage update • Postcard to update to Glenora residents • Email update to identified stakeholders, such as 124 Street Business Association, community leagues • Possible one-on-one meetings for specific stakeholders (high interest/influence) 	<p>Webpage update with link to WWW/WWD</p>
<p>Decision: Does the preliminary design require further changes to address concerns?</p>	<p>Mainly technical decisions. Bridge closure and effect on community Messaging “open for business” during construction</p>
<p>Decision Maker:</p>	<p>Project Manager</p>
<p>Role of the Public:</p>	<p>NA</p>
<p>Stakeholder Engagement Objectives:</p>	<p>Information sharing and possibly ADVISE for specific impacted stakeholders</p>
<p>Public Communication Objectives:</p>	<p>Inform the public on the project status and any relevant decisions.</p>
<p>Post-Engagement Communication:</p>	<p>NA</p>

***Project Phase 3 Pre-Construction**

<p>Communication:</p> <ul style="list-style-type: none"> • Webpage update • Postcard/brochure update to Glenora, Grosvenor, Oliver and North Glenora residents; • Emails to identified stakeholders, such as 124 Street Business Association, community leagues 	<p>Webpage update; construction brochure (detours etc.), link to 124 Street Business Association to support message: Businesses are open during construction</p>
---	--

Decision: NA	NA
Decision Maker:	Project Manager
Role of the Public:	NA
Communications Objectives:	Inform the public on the construction impacts and that businesses along 124 Street and 102 Avenue are open for business
Post-Engagement Communication:	NA

A.6 Participants, Audiences and Stakeholder Assessment

For details of interests, see [Stakeholder Mapping](#)

Stakeholder Group	How is this group affected? Level of Influence/Interest (High, Medium, Low)	What are the potential barriers to participation? (COVID-19 relates to all)	What other support can be provided to ensure participation?
102 Avenue property owners and residents	Construction impacts: detours, reduced access, increased travel times, safety, bird habitat H/H	Consultation fatigue, lack of immediate interest due to construction timeline	Proactive approach: provide information in a variety of ways: webpage, mailouts, road signs, ads, through school newsletters
102 Avenue business owners and operators	Construction impacts: detours, reduced access, increased travel times, safety, perceived and potential business impacts H/H	Previous project issues regarding effects on business, consultation fatigue, lack of immediate interest due to construction timeline	Proactive approach: provide information in a variety of ways: webpage, mailouts, road signs, ads, one-on-one meetings as required
Glenora residents	Construction impacts: detours, reduced access, increased travel times, safety, ETS route changes, bird habitat H/H	Consultation fatigue, lack of immediate interest due to construction timeline, high level of expectations	Proactive approach: provide information in a variety of ways: webpage, mailouts, road signs, ads, through school and community newsletters
Grosvenor residents	Construction impacts: increased travel times, reduced access, safety, ETS route changes, bird habitat L/L	Consultation fatigue, lack of immediate interest due to construction timeline	Proactive approach: provide information in a variety of ways: webpage, mailouts, road signs, ads, through school and community league newsletters
North Glenora and Oliver residents	Construction impacts: increased travel times, reduced access, safety, ETS route changes M/M	Consultation fatigue, lack of immediate interest due to construction timeline	Proactive approach: provide information in a variety of ways: webpage, mailouts, road signs, ads, community league newsletters

Glenora Community League	Construction impacts: increased travel times, reduced access, safety, environmental issues/concerns, trail connectivity to ravine L/H	Consultation fatigue, lack of immediate interest due to construction timeline, high level of expectations	Proactive approach: provide information in a variety of ways: webpage, mailouts, road signs, ads, early one-on-one meeting
Grovenor Community League	Construction impacts: increased travel times, reduced access, safety L/L	Consultation fatigue, lack of immediate interest due to construction timeline	Proactive approach: provide information in a variety of ways: webpage, mailouts, road signs, ad, one-on-one meetings as required
Historic/Arts Interest Groups: Edmonton Historical Board; Old Glenora Conservation Association (OGCA); Edmonton Heritage Council	Removal of landmark/ historic bridge, loss of sense of place and character OGCA - H/H Others – L/H	Potential level of engagement permitted	Proactive approach: provide information in a variety of ways: webpage, mailouts, road signs, ads, early OGCA one-on-one meeting, one-on-one meetings as required
Schools Progressive Academy, St. Vincent Catholic School, Westminster School, Glenora School	Construction impacts: increased travel times, reduced access, safety, environmental concerns/issues; connectivity, parking, bus routes L/H	Lack of immediate interest due to construction timeline	Proactive approach: provide information in a variety of ways: webpage, mailouts, road signs, ads
Special Interest Groups: River Valley Alliance; N. Sask River Valley Conservation Society; Paths for People; Bike Edmonton	Construction impacts: increased travel times, reduced access, safety, environmental concerns/issues; connectivity L/H		Proactive approach: provide information in a variety of ways: webpage, mailouts, road signs, ads. one-on-one meetings as required
Indigenous Community (by City)	Construction impacts: rare or food source vegetation in ravine, wildlife passages	No specific indigenous engagement on this project – engaged as part of community	Provide information in a variety of ways: webpage, road signs, ads
124 Street Business Association: includes High Street	Construction impacts: detours, reduced access, increased travel times, safety, perceived and potential business impacts and how to best resolve them H/H	Previous project issues regarding effects on business, consultation fatigue	Proactive approach: provide information in a variety of ways: webpage, mailouts, road signs, ads, one-on-one meetings as required, signage requirements during construction, coordinate with open for business messages and webpage links
Commuters	Construction impacts: detours, accesses, increased travel times, safety, business availability (hours and access) L/H	Commuters may come from any area – need to advise well in advance that bridge closure will occur	Proactive approach: provide information in a variety of ways: webpage, road signs, ads, “Construction on your streets”, 311

B: Stakeholder Engagement/ Public Communication Messages and Activities

B.1 Key Messages

- The Wellington Bridge, located on 102 Avenue between Churchill Crescent and Wellington Crescent, has been slated for replacement as it is reaching the end of its service life.
- The preliminary design for this bridge has started and is anticipated to be completed in spring 2021.
- Detailed design will follow and construction will be completed in coordination with Valley Line West LRT construction on Stony Plain Road.
- Construction of the Wellington Bridge is anticipated to start between 2025 and 2028.
- Geotechnical work will occur in the ravine and at the ends of the bridge in fall 2020.
- How the City will share project and construction information, i.e. webpage as main source of project information, COE PM information provided

B.2 Activities

All Phases Activity: Project Webpage	
Purpose/Decision	INFORM
Who are we informing	Public
Information participants need from us	Project history, rationale, scope, timeline, impacts, opportunities for feedback (if any) Phase 1A - Pre-engagement – geotechnical drilling Phase 1B - Preliminary Design – potential public/information event Phase 2 – Detailed Design – WWW from Ph 2 and general update Phase 3 – Pre-Construction – potential public/information event
Input we need from participants	NA
Technique(s) that will be used	Webpage development and updates as required (each stage and for public event, if required)
Materials	Text and map, link to 124 Street Business Association re: open for business in Phase 3
Staffing resources	Materials developed by consultant; webpage managed by City Communications

Phase 1A Pre-engagement Activity: Activity: 311 and Trail Signage

Purpose/Decision	INFORM
Who are we informing	Public
Information participants need from us	Trail closure and Churchill Crescent closure for geotechnical drilling – dates and impacts
Input we need from participants	NA
Technique(s) that will be used	311 and on-site signage
Materials	311 text
Staffing resources	311 by City Communications; signage by contractor

Phase 1A Pre-engagement Activity: Project Introduction Email Letter

Purpose/Decision	INFORM
Who are we informing	Identified Stakeholders
Information participants need from us	Project history, rationale, scope, timeline, impacts, opportunities for feedback (if any)
Input we need from participants	NA
Technique(s) that will be used	Email, link to project webpage
Materials	Text and map
Staffing resources	Materials developed by consultant and emailed (mailed if no email available)

Phase 1B Preliminary Design Activity: Project Introduction Mailout

Purpose/Decision	INFORM
Who are we informing	Glenora Residents
Information participants need from us	Project history, rationale, scope, timeline, impacts, opportunities for feedback (if any)

Input we need from participants	NA
Technique(s) that will be used	Mailout with link to project webpage
Materials	Text, map, postcard
Staffing resources	Materials developed by consultant; mailout by City Communications
Phases 1B & 2 Preliminary/Detailed Design Activity: One-on-one Stakeholder Meetings	
Purpose/Decision	INFORM and ADVISE
Who are we informing and engaging	Identified Stakeholders
Information participants need from us	Project history, rationale, scope, timeline, impacts, opportunities for feedback (if any)
Input we need from participants	Background information, ADVISE on detours, construction impacts, etc. feel of bridge
Technique(s) that will be used	Online/virtual meetings
Materials	Project information, FAQs
Staffing resources	Materials developed by consultant, incl. meeting summary; COE and consultant meeting attendees
Phase 1B Preliminary Design Activity: Project Update	
Purpose/Decision	INFORM
Who are we informing	Identified Stakeholders
Information participants need from us	Project history, rationale, scope, timeline, impacts, opportunities for feedback (if any)
Input we need from participants	NA
Technique(s) that will be used	Postcard mailout, project webpage, road signs indicating new info on webpage (this may be used with survey in lieu of public event)
Materials	Project information text, bridge images

Staffing resources	Materials developed by consultant; Road signs by consultant; mailout, webpage, ads by City Communications;
Phase 1B Preliminary Design Activity: Public Event (may not occur)	
Purpose/Decision	INFORM and ADVISE
Who are we informing and engaging	Public
Information participants need from us	Project history, rationale, scope, timeline, impacts, opportunities for feedback (if any), bridge images, mapping showing connections etc.
Input we need from participants	Information on perceived and potential construction impacts/concerns
Technique(s) that will be used	Email, link to project webpage, survey, road signs, ads in newspapers, community newsletters, school newsletters, mailout 2 weeks in advance of event
Materials	Project information, preliminary bridge design images
Staffing resources	Materials developed by consultant; road signs by consultant; mailout, webpage, ads by City Communications; attendance by City and consultants
Phase 2 Detailed Design Activity: Project Update	
Purpose/Decision	INFORM
Who are we informing	Public
Information participants need from us	Project history, rationale, scope, timeline, impacts, opportunities for feedback (if any), and WWH from Phase 3 public event/survey
Input we need from participants	NA
Technique(s) that will be used	Email, link to project webpage,
Materials	Project information
Staffing resources	Materials developed by consultant; webpage managed by City Communications
Phase 3 Pre-Construction Activity: Public Event (may not occur)/Brochure/Mailout	

Purpose/Decision	INFORM
Who are we informing	Public
Information participants need from us	Project history, rationale, scope, timeline, impacts, construction schedule, detours, impacts, ETS, "business as usual"
Input we need from participants	NA
Technique(s) that will be used	Emails to identified stakeholders, link to project webpage, update webpage, mailout to residents of Glenora, Grovenor, Oliver and North Glenora, road signs in advance of construction, mailout 2 weeks in advance of event
Materials	Project information brochure/mailout, maps, schedule, webpage update
Staffing resources	Materials developed by consultant; road signs by consultant; mailout, webpage, ads by City Communications; attendance by City and consultants

B.3 Data Collection, Analysis and Reporting

Data collected	How it will be recorded/analyzed	How it will be used	How it will be reported
One-on-one stakeholder meetings: Perceived and potential impacts to community (safety, detours, bus routes, business impacts)	Comment summary	Reviewed by project team and considered/addressed	Meeting summary and What We Heard
One-on-one stakeholder meetings: Experience of bridge	Comment summary	Reviewed by project team and considered/addressed	Meeting summary and What We Heard

B.4 Evaluation Plan

Activity	How it will be measured	How it will be reported
Public Event	Participant Feedback Form Public Engagement Event Debrief	Shared with team

B.5 Engagement and Communication Timelines

See [Schedule](#)

B.6 Engagement Challenges and Opportunities

Opportunity/Challenge/Risk	Description	Mitigation Strategy/Notes
Highly invested and influential stakeholders	OGCA and Glenora Community League have been highly invested and influential in past projects and have high expectations. Strong ties to councillor.	Strong messaging, clear opportunities for feedback (if any). COE PM to keep councillor updated on the project; providing key messages, goals and objectives and project status so that the same messaging is used by all parties.
Highly invested stakeholder	124 Street Business Association represents a large group of active businesses that will be impacted to varying degrees during construction. The messaging of this group in the past is that the Groat Road over 102 Avenue Bridge construction severely impacted their businesses. Access was limited to some sites, signage identifying business as usual was not sufficient, and closures were identified as a result of the construction	Build a strong connection with 124 BA and keep them informed about the status of the project and potential impacts well in advance of construction. Indicate on COE webpage that business will occur as usual and possibly provide link to 124 St BA directory to show support of the area. Require Contractor provide 'business as usual' or 'businesses open' signs along 124 Street and 102 Avenue. Place information in local newsletters and 124 Street BA webpage.

C: Review and Approval

Review and Approval	
Created By	Carol Craig, FCSLA
Peer Reviewed	
Approved By	<i>Cyril Balitbit</i> - November 23, 2020

D: Tracking Changes

Date	Change	Made by	Comments
April 1, 2021	Update approach re; businesses on High Street	Carol Craig	

E: Commitment Tracking

Date	Commitment	Made to	Made by



Wellington Bridge Replacement Meeting Summary

Stakeholder: Urban Form and Corporate Strategic Planning

Date: August 28, 2020, 3 pm

Attendees: Peter Spearey, Urban Form and Corporate Strategic Planning; Cyril Balitbit, Transportation Planning and Design; Tara Alexander, AE; Carol Craig, Kinnikinnick Studio

Summary provided to: Attendees; Chris Pyra, AE

Recorded by: Carol Craig

Discussion: *The intent of the meeting was to gain an understanding of external stakeholders with an historic interest in the Wellington Bridge (such as Old Glenora Conservation Association, Edmonton Historical Board). An understanding of the Edmonton Arts Council's (EAC) role/interest was also sought.*

1. It was recommended that the project team discuss stakeholders with an historic interest with the COE Heritage Planners David Johnston and/or Scott Ashe. **Action: Cyril to coordinate a meeting.**
2. The 1% for Art has been identified as a requirement for this project. The value of the funds will be determined near the end of preliminary design (approx. April 2021), as it is based on the construction cost of the bridge.
3. How the 1% for Art funds may be used may change before bridge construction as the policy is under review. Dependent on the policy revisions, the funds may be used on/near the bridge, or may be part of a general fund for public art in the city, or another arrangement as determined in the review.
4. The current process for public art selection is:
 - a. The amount of funding is determined
 - b. The EAC procures an artist (process by the EAC)
 - c. Once selected, the artist creates and installs the piece(s). The piece(s) may be stand alone or integrated into the project.
 - d. The art installation is determined by the artist, and is based on criteria/parameters provided by EAC as part of the procurement process. It is not in the realm of the project team or EAC to determine what will be created/installed.
5. It was recommended that a project introduction meeting with the EAC be set up. David Turnbull is Director of Public Art and Conservation. He is the best contact. He is currently on vacation but Peter has a meeting with him upon his return and will indicate that the EAC will be contacted regarding the Wellington Bridge project. **Action: Carol to coordinate a meeting.**
6. The proposed EAC meeting will include the following topics:
 - a. Scope of Wellington Bridge Replacement
 - b. Construction budget to be determined in spring 2021
 - c. % for Art is a component of this project but no budget is established at this time
 - d. Project timeline (to completion)
 - e. Others as determined in the meeting

This meeting summary is considered to be complete and correct. Please advise the writer within one week of any errors or omissions, otherwise this meeting summary will be considered to be an accurate record of the discussions.



Wellington Bridge Replacement Meeting Summary

Stakeholders: Historic Resources and Policy Development

Date: August 31, 2020, 3:30 pm

Attendees: Scott Ashe, Historic Resources; James Haney, Policy Development; Cyril Balitbit, Transportation Planning and Design; Chris Pyra, AE; Carol Craig, Kinnikinnick Studio

Summary provided to: Attendees; Tara Alexander, AE

Recorded by: Carol Craig

Discussion: *The intent of the meeting was to gain an understanding of external stakeholders with an historic interest in the Wellington Bridge. Heritage Resources works with heritage interest groups. Policy Development was invited to the meeting as they are currently working with Old Glenora Conservation Association (OGCA) on the Old Glenora Heritage Character Rezoning project and have insight into the group.*

https://www.edmonton.ca/city_government/edmonton_archives/glenora-heritage-character-area.aspx

1. The Heritage Character project identifies important character areas/elements within Old Glenora. 102 Avenue is one of three heritage character areas identified. Historic stories of the neighbourhood, including the bridge, have been captured in this study.
2. OGCA is a vocal, well-educated group that represents Old Glenora residents (south of Stony Plain Road). They have high influence/ high interest, in particular with the bridge character. They will go to the councilor (Scott McKeen, Ward 6), if required, to voice their opinion and impact decisions. They have a mailout list of +/- 150-200 in the neighbourhood and claim interest from more.
3. A Heritage Character public event was scheduled for March 12, 2020 but was cancelled on very short notice due to COVID-19 restrictions. This may have upset OGCA. Online engagement starts next month for this project.
4. OGCA has high expectations for information and engagement. Providing information in a transparent manner and as early as possible is the preferred strategy.
5. North Glenora (north of Stony Plain Road) is represented by the Glenora Community League. They are a more moderate group with an understanding of community issues. They are less interested/involved in development than OGCA.
6. The Edmonton Historical Board acts as an advisor to Council on matters of heritage. They have a reasonable understanding of issues and will be interested in retaining/preserving the bridge, if possible. They are not directly impacted as they are not specific to Old Glenora and have less of a vested interest. They will need to be kept informed.
7. The Edmonton Heritage Council was identified as an internal stakeholder. This group operates in a similar manner as the Edmonton Arts Council. They have a cultural heritage focus but have become more interested in historic resources. They will need to be kept informed.
8. The discussion included the timing of providing project information. Some decisions, such as a new bridge vs retention/reuse of bridge components, are technical and should be made prior to informing external stakeholders. However, information should go out to OGCA/Old Glenora residents as soon as these decisions are made.

This meeting summary is considered to be complete and correct. Please advise the writer within one week of any errors or omissions, otherwise this meeting summary will be considered to be an accurate record of the discussions.



Wellington Bridge Replacement Meeting Summary

Stakeholders: Neighbourhood Renewal/Building Great Neighbourhoods (BGN)

Date: Sept 3, 2020, 4 pm

Attendees: Cathy Dytiuk, BGN; Linda Billey and Cyril Balitbit, Transportation Planning and Design; Tara Alexander, AE; Carol Craig, Kinnikinnick Studio

Summary provided to: Attendees; Chris Pyra, AE

Recorded by: Carol Craig

Discussion: *The intent of the meeting was to gain an understanding of external stakeholders with a community connection/ interest in the Wellington Bridge. The Glenora community went through a Neighbourhood Renewal in +/-2012. This program was the precursor to Building Great Neighbourhoods (BGN).*

1. The Neighbourhood Renewal process was predominately at the INFORM level with some ADVISE. Stakeholders were first engaged and the initial plans were formally presented to the public for comment. A second open house close to the end of design was also held with a formal presentation – similar to what is now a pre-construction meeting.
2. Lessons learned from the Neighbourhood Renewal:
 - a. Community league is very vocal and active with a high attention to detail. They will have high interest and high influence in the project.
 - b. Community members (lawyers) were critical of any information and often asked for clarity. COE Law ended up reviewing all email correspondence (in and out).
 - c. Many residents are afraid to speak out against the vocal group and indicated privately that they were in support of the project.
 - d. Making changes resulting from community push back on sidewalk locations provided them with a sense of power to influence the project, which they took full advantage of. An additional public event was held to respond to construction issues.
3. Suggested approach included a visioning exercise with select stakeholders. This would provide information on what was going to happen (the bridge is being replaced), why (the bridge is nearing the end of its service life, does not meet standards, does not accommodate all modes of transportation; is not safe – or will not be safe). The event could also ask questions to determine what is important about the existing bridge that might be re-interpreted/included and what might be missing from the existing bridge that may be included in a new bridge. It was recommended that this occur before design commences.
4. It was suggested that the BGN Engagement Mapping be reviewed for ideas as well as the Millcreek Bridge Replacement PEP.

This meeting summary is considered to be complete and correct. Please advise the writer within one week of any errors or omissions, otherwise this meeting summary will be considered to be an accurate record of the discussions.



Wellington Bridge Replacement Meeting Summary

Stakeholders: Edmonton Arts Council (EAC)

Date: November 9, 2020, 3:30 pm

Attendees: David Turnbull, Robert Harpin, Edmonton Arts Councils; Peter Spearey, Urban Form; Cyril Balitbit, Joanna Young, Transportation Planning and Design; Chris Pyra, Jessica Gagne, AE; Carol Craig, Kinnikinnick Studio

Summary provided to: Attendees; Tara Alexander, AE

Recorded by: Carol Craig

Discussion: *The intent of the meeting was to gain an understanding of the EAC process and potential for art for the Wellington Bridge Replacement Project. Urban Form liaises between the EAC and City projects.*

Meeting Summary

Project Background

The Wellington Bridge, located on 102 Avenue between Churchill Crescent and Wellington Crescent, has been slated for replacement as it is reaching the end of its service life. The site investigation phase has been completed. Preliminary design for this bridge has started and is anticipated to be completed in summer 2021. Several options are being considered and a preferred option will be developed by April 2021. Detailed design will follow and the project will be put on hold until the LRT construction is near completion on Stony Plain Road. Construction is anticipated to start between 2025 and 2028 and is dependent on the LRT construction.

The Wellington Bridge was originally constructed in 1932, it serves as an arterial roadway with four lanes of traffic (two lanes in each direction), and has a sidewalk on both sides of the bridge. It is a major link between Edmonton's city centre and communities to the west. The bridge crosses Ramsey Ravine which features a shared pathway connecting the community of Glenora to the river valley. The bridge is also part of West Central Bike Routes' 102 Avenue Shared Use Pathway (SUP).

As the bridge is listed in the Register of Historic Resources in Edmonton and Alberta Historic Resources Management Branch, the project team will consider incorporating two of its existing historic features, the concrete railings and concrete arches, into the bridge design - to be re-used on the new bridge, or reinterpreted in the new design. Alberta Historic Resources also requires documentation of the existing bridge.

EAC Process Discussion

The EAC sees Wellington Bridge as a location for public art. This art may be located on or adjacent to the bridge, including next to the SUP below the bridge.

The EAC process is a 2 stage RFQ process and has recently been revised:

This meeting summary is considered to be complete and correct. Please advise the writer within one week of any errors or omissions, otherwise this meeting summary will be considered to be an accurate record of the discussions.

Stage 1 - Local, national or international call for RFQ may be issued and the call is dependent on the budget. Background information on the project is provided and may include design restrictions/guidelines for art locations and types. No maquette and no fixed concept is required.

Stage 2 - A short list is developed from the submissions and interviews follow. The potential artists present their portfolio, their level of experience, how they work with design teams and public engagement experience (if a part of the process). An artist is then selected and an Memorandum of Understanding (MOU) is developed between the City and EAC. This document covers items such as art budget and maintenance for the project.

Once the artist has been selected a two phase contract is prepared:

Phase 1 - Concepts are developed first with input from the design team. Several sites associated with the project may be included. Note: restrictions about the art can be stipulated by the project team.

Phase 2 - Form and feasibility are investigated and is followed by development of the detailed design and tender package for a specific site associated with the project. There is a desire that some supporting structures such as foundations be part of the bridge project, not the art project. This helps to increase the size of the art project. Cost sharing is also a consideration if the full costs cannot be covered.

The 1% for Art received covers the following:

1. 10% for administration
2. 10% goes into a conservation pool for care and maintenance.
3. There is a contingency for inflation and unforeseen issues.

The money needs to be provided to the EAC upfront where possible as there may be a cash flow issue if it is not received at this time.

Growth vs Renewal Discussion

Previous projects have used the growth component as the qualifying portion of the project cost for % For Art. It is anticipated that the Wellington Bridge Replacement project will have approximately a 30% growth component. The EAC has a concern about how growth is determined. The policy indicates to some extent what may be included but is not clear The EAC is uncertain as to how % For Art is applied to bridge projects that have growth and renewal components. They do not see this as a transparent process with regards to what is included as part of growth and what qualifies as part of the 1% for Art.

The anticipated overall construction budget is approximately \$10 million (base price).

Confirmation as to how the process was applied to the 102 Avenue Bridge over Groat Road may help understand how this works. Peter Speary may be able to provide some of this information and Cyril and Joanna will also do some investigation to clarify.

Next Steps

At the end of preliminary design a preferred option will be presented. This will be reviewed with EAC to determine where art may be installed. There is a risk with the timing of the bridge construction - the development of the art will have to be done well in advance of installation.

Detailed design is anticipated to be completed in 2021 and the art will have to be integrated into the development of the drawing/tender package.

Start Architecture is part of the project team and they are familiar with working with artists on bridge projects.

This meeting summary is considered to be complete and correct. Please advise the writer within one week of any errors or omissions, otherwise this meeting summary will be considered to be an accurate record of the discussions.

Wellington Bridge Replacement Meeting Summary - Bike Edmonton

Date: January 21, 2021, 1:30pm via Zoom

Attendees: Chris Chan, Executive Director, Bike Edmonton (BE); Cy Balitbit, City of Edmonton; Tara Alexander, AE; Carol Craig, Kinnikinnick Studio

Meeting Intent: The intent of the meeting is to introduce the project to Bike Edmonton and gather information on cyclist concerns and needs for safe cycling on and below the bridge. Bike Edmonton represents all cyclists but has a focus on cycling as transportation.

Bridge Background

- The Wellington Bridge, located on 102 Avenue between Churchill Crescent and Wellington Crescent, was originally constructed in 1932.
- It serves as an arterial roadway with four lanes of traffic (two lanes in each direction), and has a sidewalk on both sides of the bridge. It is a major link between Edmonton's city centre and communities to the west.
- The bridge crosses Ramsey Ravine which features a shared use pathway within a natural area connecting the community of Glenora to the river valley.
- The bridge is also part of West Central Bike Routes' 102 Avenue Shared Use Pathway (SUP).
- The Wellington Bridge has been slated for replacement as it is reaching the end of its service life. A reasonable expectation for the service life for a bridge in Edmonton is 75 years. Wellington Bridge is now approximately 89 years old.
- The site investigation phase has been completed and it has been determined that it is not feasible to rehabilitate or repair the bridge.

Project Timeline

- Preliminary design for this bridge has started and is anticipated to be completed in summer 2021.
- Several options are being considered and a preferred option will be developed by May 2021.
- Decision criteria include, but are not limited to: environmental and geotechnical requirements; design standards; capital and maintenance costs; inclusion of Shared Use Path on north side; inclusion of pedestrian walk on south side; construction methods; and best practices for bridge design.
- Detailed design will follow and be completed in early 2022.
- Once detailed design is completed, the project's construction timeline will be coordinated with the LRT construction on Stony Plain Road.
- Construction is anticipated to start between 2025 and 2028 and is dependent on the LRT construction.
- Bridge construction, once started, will take approximately 2 years. This will be confirmed through the next stages of design.

Anticipated Impacts

- 102 Avenue is anticipated to be closed for construction, from approximately 40 metres west of Churchill Crescent to 40 metres east of Wellington Crescent.
- Detour maps will be provided to the public prior to construction.
- Changes to the existing roadway grades of Churchill Crescent and Wellington Crescent will be minimized. This will reduce impacts to the adjacent properties and reduce the construction area. However, both of these roads will not have vehicular and pedestrian access to and from 102 Avenue for the duration of construction. Portions of the crescents may be used for staging of construction. This will be finalized during detailed design and

- discussions with immediately impacted stakeholders will occur.
- Environmental and geotechnical studies are being conducted and will provide direction for the design and rehabilitation of the site, including the river valley below the bridge. The River Valley Bylaw 7188 requirements will be met.
- The trail in the ravine that passes under the bridge will be closed for the bridge construction.

Discussion:

Comments by stakeholders in standard font. Responses in *italics*.

- The historic features of the existing bridge are seen more from the ravine than the road. BE does not see a high value in retaining these. However, BE indicated that the community may see a high value in the historic features.
- Cyclists being impacted by splashing from vehicles is often an issue on bridges. BE indicated that this will probably be alleviated by the proposed road shoulder and path shy zones.
- Drainage on the SUP is important. Ponding will cause issues with splashing and icy areas during winter. *Drainage will be across the sidewalk/SUP to the road so there should be little ponding.*
- Concern about the NW approach from the SUP to the existing bridge - hard to read and manage as a cyclist. *The bridge will be wider than the existing bridge and the access from boulevard SUP to bridge SUP will be more direct and easily understood at both ends of the new bridge.*
- A suggested east-west detour during the 102 Avenue closure is through the neighbourhood: north on 132 Street up to a back alley (south of 104 Avenue), then south on Glenora Crescent NW - 103 Avenue - south on 130 Street to 102 Avenue. Signage for detour and notification to owners backing on to the back alley was also suggested. *Project team will consider this as the project moves forward.*
- The path under the bridge sometimes experiences falling ice from the bridge. *Project team will consider this in the design.*
- The path under the bridge will be closed. This was not considered an issue for commuter cyclists but may be an issue for the community. *Detours will be developed and provided to the community. Detour signage will also be considered during construction: possible trail locations for signage include McKinnon Ravine/142 Street, Groat Road, St. George Crescent, and 132 Avenue alley connection. Residents adjacent to higher volumes of detour bike traffic may have to be notified.*
- Bridge handrails and barriers should be at a height that does not impact handlebars. *Design heights will meet standards: handrails will be +/-1.37m high and barriers will be +/-0.8m high.*

Next Steps

- Comments received from this meeting may be considered in the design.
- A preferred option will be provided to the public in late spring 2021 near the end of preliminary design.

The subjects discussed, and decisions reached, are summarized in this document. Please notify the author of any errors or omissions. If comments are not received within 7 days, this record is considered correct.

Wellington Bridge Replacement Meeting Summary - Old Glenora Conservation Association (OGCA)

Date: January 26, 2021, 7:30pm via Zoom

Attendees: Barbara Finlay, Dushan Bednarsky, Doug Matheson, Wendy Antoniuk, Dave Percy, OGCA; Cy Balitbit, City of Edmonton; Tara Alexander, Associated Engineering; Carol Craig, Kinnikinnick Studio

Meeting Intent: The intent of the meeting is to introduce the project to the Old Glenora Conservation Association and gather information on local knowledge, bridge use, etc. OGCA focusses on heritage preservation within the Glenora neighbourhood.

Bridge Background

- The Wellington Bridge, located on 102 Avenue between Churchill Crescent and Wellington Crescent, was originally constructed in 1932.
- It serves as an arterial roadway with four lanes of traffic (two lanes in each direction), and has a sidewalk on both sides of the bridge. It is a major link between Edmonton's city centre and communities to the west.
- The bridge crosses Ramsey Ravine which features a shared use pathway within a natural area connecting the community of Glenora to the river valley.
- The bridge is also part of West Central Bike Routes' 102 Avenue Shared Use Pathway (SUP).
- The Wellington Bridge has been slated for replacement as it is reaching the end of its service life. A reasonable expectation for the service life for a bridge in Edmonton is 75 years. Wellington Bridge is now approximately 89 years old.
- The site investigation phase has been completed and it has been determined that it is not feasible to rehabilitate or repair the bridge.

Project Timeline

- Preliminary design for this bridge has started and is anticipated to be completed in summer 2021.
- Several options are being considered and a preferred option will be developed by May 2021.
- Decision criteria include, but are not limited to: environmental and geotechnical requirements; design standards; capital and maintenance costs; inclusion of Shared Use Path on north side; inclusion of pedestrian walk on south side; construction methods; and best practices for bridge design.
- Detailed design will follow and be completed in early 2022.
- Once detailed design is completed, the project's construction timeline will be coordinated with the LRT construction on Stony Plain Road.
- Construction is anticipated to start between 2025 and 2028 and is dependent on the LRT construction.
- Bridge construction, once started, will take approximately 2 years. This will be confirmed through the next stages of design.

Anticipated Impacts

- 102 Avenue is anticipated to be closed for construction, from approximately 40 metres west of Churchill Crescent to 40 metres east of Wellington Crescent.
- Detour maps will be provided to the public prior to construction.
- Changes to the existing roadway grades of Churchill Crescent and Wellington Crescent will be minimized. This will reduce impacts to the adjacent properties and reduce the construction area. However, both of these roads will not have vehicular and pedestrian

access to and from 102 Avenue for the duration of construction. Portions of the crescents may be used for staging of construction. This will be finalized during detailed design and discussions with immediately impacted stakeholders will occur.

- Environmental and geotechnical studies are being conducted and will provide direction for the design and rehabilitation of the site, including the river valley below the bridge. The River Valley Bylaw 7188 requirements will be met.
- The trail in the ravine that passes under the bridge will be closed for the bridge construction.

Discussion:

Comments by stakeholders in standard font. Responses in *italics*.

- Is the bridge condition assessment available? *Findings of preliminary engineering report will be shared with the stakeholder, including information regarding the current bridge condition and recommended bridge design option, at the end of preliminary engineering phase of the project.*
- OGCA indicated that other cities have been able to retain, restore and/or rehabilitate historic bridges even with widening. *Every bridge project has different design considerations and challenges. The Wellington Bridge is near the end of its life. Shoring now in place under the bridge allows this project to be considered for construction after the LRT construction along 104 Avenue. The City looked at rehabilitating the bridge. The costs for rehabilitation, along with other considerations such as bridge condition, safety, new standards (e.g. change in sidewalk and lane widths), existing site conditions (i.e. landslides), bridge widening requirement (i.e. SUP) and the ongoing maintenance required due to the age of the existing bridge if retained, did not support this option.*
- How wide is the proposed bridge versus the existing bridge? *The proposed bridge is approximately 23.7m wide. The existing bridge is approximately 16.1m. This is a difference of +/-7.6m. The north sidewalk width will be increased to a 4.2m SUP and the south sidewalk width will be increased to 2.8m. The traffic lane widths will be increased from 3.0m to 3.3m and a 1.1m shoulder added. The SUP on the bridge will line up with the SUP on the boulevard, reducing the number of cyclists on the road and user conflicts between cyclists and pedestrians.*
- How much width can be added to the existing bridge? *No additional width can be added due to the bridge condition. Additional structural girders would need to be added to the outside walls of the bridge to support the additional width (if the bridge could support any additional weight). This would impact the aesthetics of the existing bridge.*
- Can the existing walls/facades be duplicated to help support the widening? *This could be done but the deteriorating structure of the existing bridge would still require significant structural work as well.*
- The new bridge is wider which will attract higher traffic volumes. The traffic from 104 Avenue (during and after LRT construction) will move to 102 Avenue. *There will be the same number of lanes as the existing bridge (2 each way). The widening is mainly to support the addition of the SUP and roadway width to meet current city standards. It is anticipated that during LRT construction the traffic from 104 Avenue will probably use both 107 and 102 Avenue. It is hard to predict how much will shift to 102 Avenue during LRT construction, or for the long term, once LRT construction is completed.*
- From the roadway, the key element on the existing bridge is the balustrade. From the ravine, the key elements are the arches (both large and small) and pilaster details. The strong architectural features in a natural setting is magnificent. *The City understands this and is looking at how the balustrades might be used in a different way on, or near, the site (such as the ravine). The balustrades do not meet safety standards regarding height and spacing between them. The arches could be reinterpreted in the new bridge. This interpretation could have a similar visual aesthetic/impact from the ravine.*
- The OGCA prefers a heritage appearance rather than a modern interpretation. The heritage aesthetic of a new bridge would have to be sensitively handled.

- The existing bridge is an iconic structure in the City. Stakeholders requested that the project team also consider the importance of beauty and not just costs. This bridge is important to people outside of the area too.
- The river valley is the jewel of the city and beauty affects people in a way that goes beyond dollars and cents. The benefits of aesthetics on people's wellbeing is important.
- The OGCA can accept the bridge being replaced but wants the design to replicate the heritage bridge architecture.
- Revegetation of the ravine will be important - helps to stabilize banks. The 102 Avenue over Groat Road bridge revegetation works well. Care must be taken to plant material closely so that shortcutting and erosion does not occur.
- Handrail must be beautiful but not climbable. Allow for sight lines from vehicles to handrail (through or over the barrier). Barrier should be aesthetically pleasing as well.
- Consider the SUP on the south side where the intersections (number and size) are less formidable. If this can't occur, discourage cyclists from using the south sidewalk to reduce conflicts with pedestrians.
- Drainage - the larger deck will have more runoff. How will this be handled? *Drainage will go to the ravine in a similar fashion to the current system. The new profile will provide better drainage off the bridge and shed water quickly. There will be catch basins at the ends of the bridge as is currently found. The bridge will be higher at the middle and slope to the ends.*
- There has been significant flooding at Churchill Crescent intersection in front of the new house. *The drainage (catch basin and pipes to ravine outlet) at this location will be considered during the design and repaired/replaced as needed.*
- What will traffic management during construction look like? Shortcuts need to be discouraged. *The traffic detours will encourage traffic to use 107 Avenue. No detours will be identified though the neighbourhood. The detour plan will be developed closer to the time of construction.*

Next Steps

- Comments received from this meeting may be considered in the design.
- A preferred option will be provided to the public in late spring 2021 near the end of preliminary design.
- A meeting with OGCA will be set up before the preferred option is provided to the public.
- The Edmonton Arts Council will be brought in after preliminary design is complete. A call for artists will be made.

The subjects discussed, and decisions reached, are summarized in this document. Please notify the author of any errors or omissions. If comments are not received within 7 days, this record is considered correct.

Wellington Bridge Replacement Meeting Summary - Paths for People (PP)

Date: January 29, 2021, noon via Zoom

Attendees: Stephen Ratz, Dave Buchanan, Paths for People; Cy Balitbit, City of Edmonton; Jessica Gagne, Associated Engineering; Carol Craig, Kinnikinnick Studio

Meeting Intent: The intent of the meeting is to introduce the project to Paths for People and gather information on local knowledge, bridge use, and user needs.

Bridge Background

- The Wellington Bridge, located on 102 Avenue between Churchill Crescent and Wellington Crescent, was originally constructed in 1932.
- It serves as an arterial roadway with four lanes of traffic (two lanes in each direction), and has a sidewalk on both sides of the bridge. It is a major link between Edmonton's city centre and communities to the west.
- The bridge crosses Ramsey Ravine which features a shared use pathway within a natural area connecting the community of Glenora to the river valley.
- The bridge is also part of West Central Bike Routes' 102 Avenue Shared Use Pathway (SUP).
- The Wellington Bridge has been slated for replacement as it is reaching the end of its service life. A reasonable expectation for the service life for a bridge in Edmonton is 75 years. Wellington Bridge is now approximately 89 years old.
- The site investigation phase has been completed and it has been determined that it is not feasible to rehabilitate or repair the bridge.

Project Timeline

- Preliminary design for this bridge has started and is anticipated to be completed in summer 2021.
- Several options are being considered and a preferred option will be developed by May 2021.
- Decision criteria include, but are not limited to: environmental and geotechnical requirements; design standards; capital and maintenance costs; inclusion of Shared Use Path on north side; inclusion of pedestrian walk on south side; construction methods; and best practices for bridge design.
- Detailed design will follow and be completed in early 2022.
- Once detailed design is completed, the project's construction timeline will be coordinated with the LRT construction on Stony Plain Road.
- Construction is anticipated to start between 2025 and 2028 and is dependent on the LRT construction.
- Bridge construction, once started, will take approximately 2 years. This will be confirmed through the next stages of design.

Anticipated Impacts

- 102 Avenue is anticipated to be closed for construction, from approximately 40 metres west of Churchill Crescent to 40 metres east of Wellington Crescent.
- Detour maps will be provided to the public prior to construction.
- Changes to the existing roadway grades of Churchill Crescent and Wellington Crescent will be minimized. This will reduce impacts to the adjacent properties and reduce the construction area. However, both of these roads will not have vehicular and pedestrian access to and from 102 Avenue for the duration of construction. Portions of the crescents may be used for staging of construction. This will be finalized during detailed design and discussions with immediately impacted stakeholders will occur.

- Environmental and geotechnical studies are being conducted and will provide direction for the design and rehabilitation of the site, including the river valley below the bridge. The River Valley Bylaw 7188 requirements will be met.
- The trail in the ravine that passes under the bridge will be closed for the bridge construction.

Discussion:

Comments by stakeholders in standard font. City/project team responses in *italics*.

- Does this have to be a full closure during construction? *Options have been looked at but due to technical issues, this will probably be the direction for replacement.*
- *How would PP describe the existing bridge experience?* The current barriers and access to the bridge are horrible. There is a bottleneck at the entrance to the sidewalk on the northside of the bridge. Cyclists are supposed to dismount and walk over, but in most cases this does not occur. There is a conflict between pedestrian and cyclist which is a source of tension and anxiety. Cyclists often move onto the vehicle lanes causing other concerns.
- The SUP design is fantastic: PP is glad to see the new design that removes bottle neck and provides a more direct line of travel. However, the SUP may introduce more conflicts between cyclists and pedestrians.
- *Does the outside barrier feel low?* It is beautiful and from an experienced cyclist's perspective is fine. However, less experienced cyclists feel exposed. The new design feels more safe and a higher barrier will improve the experience. The heritage barrier looks nice - perhaps find a way to provide the historic aesthetic on the new bridge - but increase the height. Would be nice to have areas of lower barrier to allow for views of the ravine. Many pedestrians now stop and rest their forearms on the top of the balustrade to look at the views. *Project team will look at possible opportunities for this.*
- Perhaps retain some of the historic elements in the new overall design. Some elements may be salvaged and reused elsewhere on site.
- *What about the experience underneath the bridge?* The experience on top of the bridge is more utilitarian - getting from one place to another. The experience below is more relaxed and informal. Lighting would be good as it is a 'spooky' place in the evening. However, a balance must be struck as this is a natural area. The arches are striking - maintain if possible in the new design. The equipment (shoring) has been in place for a very long time and restricts views. The bridge looks great from a distance but it is apparent that it is not in good condition when the user is close. *The City will not pursue lighting as this does not reflect the environmental policies. Wildlife corridors should not have lighting as it deters wildlife movement.*
- *What is your opinion on a modern archway rather than a like-for-like bridge?* Note: the like-for-like would not be identical as the width and scale would require resizing some bridge elements. Capture the spirit in a new design. The bridge will obviously be larger but a narrower street could still work. Is there any data to back up the need for wider lanes? *It is difficult to build a bridge that does not meet current standards.*
- Consider future proofing the design - will the future city need a wider bridge? For example, three lanes may meet the needs of the city in the future as user needs change. How can the bridge be designed to provide this? Could we maintain the existing width? *It is relatively simple to reduce the number of lanes and increase pedestrian/cyclist areas within the proposed bridge width. However, widening a bridge to meet new needs is more difficult and expensive. The current design does not prevent the proposed uses from being modified for different uses, and offers more flexibility for the future. The road corridor to the west was looked at and the new bridge will better match this. It will be challenging to widen the road corridor in the future. 102 Avenue is anticipated to stay the same width for the next 25 years or so, and it is currently not on any list for rehabilitation. The status could change as it is based on an annual inspection which may identify issues. 107 Avenue has potential to accommodate traffic. There is less front facing properties on 107 Avenue.*

- There is a need to push for more places for people in Edmonton.
- Could the City consider replacing this bridge before LRT construction? *The LRT contract is a Public Private Partnership (P3) with a proposed startup of 2021-2022. The Wellington Bridge design will not be ready for construction in advance of the LRT construction start.*
- Are there interim ways to improve the existing bridge? *The structure is the end of its service life. The bridge is safe with the shoring and ongoing maintenance. It is more beneficial to replace the bridge than spend additional dollars to make minor changes for an interim solution.*
- Is it possible to build the SUP as a separate bridge? An SUP bridge could be built right away and solve the cyclist/pedestrian conflicts. *The site footprint is very constrained. The existing landslide in the NW area of the bridge adds another issue. A separate SUP bridge would also interfere with the demolition/construction of the new vehicle bridge. There would be increased environmental impacts and costs.*
- It would be preferred to have the SUP before 2025 as the bottleneck is a major problem for all users. Active transportation needs to provide efficient ways to move through the city. Cyclist travel is not considered as important as vehicle travel and this needs to be looked at by the City. An SUP on both sides of the bridge and along 102 Avenue is preferred.
- Can some interim tactical improvements, such as additional crosswalks to allow easy access to the north path, be installed? This would need to be on both ends of the bridge. *This will be looked at by the City.*
- *Do you have a preferred bridge handrail in the City?* 102 Avenue Bridge over Groat Road: do not love the narrow slats, they obscure the view. The best is probably Walterdale: the design lends itself to leaning on the handrail. The Louise McKenny Promenade also has a very nice handrail design.
- Do you have any suggestions regarding the 102 Avenue closure and detours? *This closure severs a very strong E/W connection and there are not a lot of N/S options to get around the closure. Any shortcuts for peds/cyclists within the neighbourhood will have to be maintained in the winter. Strong wayfinding will also be required and the adjacent residents will have to be informed to reduce conflicts.*
- The City requires a grander vision piece to influence future projects. The vision would be more wholistic, and ultimately provide more and better places for people, rather than for vehicles.
- Art under the bridge would be interesting and improve the enjoyment of the corridor. The art under the James MacDonald Bridge significantly improved the user experience.

Next Steps

- Comments received from this meeting may be considered in the design.
- A preferred option will be provided to the public in late spring 2021 near the end of preliminary design.
- The Edmonton Arts Council will be brought in after preliminary design is complete. A call for artists will be made.

The subjects discussed, and decisions reached, are summarized in this document. Please notify the author of any errors or omissions. If comments are not received within 7 days, this record is considered correct.

Wellington Bridge Replacement Meeting Summary - 124 Street BA

Date: February 12,, 2021, noon via Zoom

Attendees: Luwam Kiflemariam, Executive Director, 124 Street Business Association; Cy Balitbit, City of Edmonton; Tara Alexander, Associated Engineering; Carol Craig, Kinnikinnick Studio

Meeting Intent: The intent of the meeting is to introduce the project to 124 Street Business Association and gather information on local knowledge, bridge use, and user needs.

Bridge Background

- The Wellington Bridge, located on 102 Avenue between Churchill Crescent and Wellington Crescent, was originally constructed in 1932.
- It serves as an arterial roadway with four lanes of traffic (two lanes in each direction), and has a sidewalk on both sides of the bridge. It is a major link between Edmonton's city centre and communities to the west.
- The bridge crosses Ramsey Ravine which features a shared use pathway within a natural area connecting the community of Glenora to the river valley.
- The bridge is also part of West Central Bike Routes' 102 Avenue Shared Use Pathway (SUP).
- The Wellington Bridge has been slated for replacement as it is reaching the end of its service life. A reasonable expectation for the service life for a bridge in Edmonton is 75 years. Wellington Bridge is now approximately 89 years old.
- The site investigation phase has been completed and it has been determined that it is not feasible to rehabilitate or repair the bridge.

Project Timeline

- Preliminary design for this bridge has started and is anticipated to be completed in summer 2021.
- Several options are being considered and a preferred option will be developed by May 2021.
- Decision criteria include, but are not limited to: environmental and geotechnical requirements; design standards; capital and maintenance costs; inclusion of Shared-use Path on north side; inclusion of pedestrian sidewalk on south side; construction methods; and best practices for bridge design.
- Detailed design will follow and be completed in early 2022.
- Once detailed design is completed, the project's construction timeline will be coordinated with the LRT construction on Stony Plain Road.
- Construction is anticipated to start between 2025 and 2028 and is dependent on the LRT construction.
- Bridge construction, once started, will take approximately two years. This will be confirmed through the next stages of design.

Anticipated Impacts

- 102 Avenue is anticipated to be completely closed for construction, from approximately 40 metres west of Churchill Crescent to 40 metres east of Wellington Crescent.
- Detour maps will be provided to the public prior to construction.
- Changes to the existing roadway grades of Churchill Crescent and Wellington Crescent will be minimized. This will reduce impacts to the adjacent properties and reduce the construction area. However, both of these roads will not have vehicular and pedestrian access to and from 102 Avenue for the duration of construction. Portions of the crescents may be used for staging of construction. This will be finalized during detailed design and discussions with immediately impacted stakeholders will occur.
- Environmental and geotechnical studies are being conducted and will provide direction for

the design and rehabilitation of the site, including the river valley below the bridge. The River Valley Bylaw 7188 requirements will be met.

- The trail in the ravine that passes under the bridge will be closed for the bridge construction.

Discussion:

Comments by stakeholder in standard font. City/project team questions and responses in *italics*.

What feedback and/or neighbourhood information can 124 Street BA provide regarding possible detours or construction impacts?

- The businesses in the area feel that their concerns were not addressed with the 102 Avenue over Groat Road Bridge replacement. They felt that they were left stranded and were not well informed. Loss of business and business closures were attributed to the bridge construction and road closure.
- These feelings will be at the forefront of how the Wellington Bridge Replacement project is perceived.
- The LRT is also at the top of mind of the current businesses and the upcoming LRT construction will be difficult to separate from the Wellington Bridge Replacement. Information on both may have to be provided at the same time.

What type of traffic information would assist the 124 Street BA and the impacted businesses understand the project?

- Planned detours and traffic impacts into/through the area along 124 Street and 102 Avenue. Some of these stores/businesses are destinations and need easy access to succeed.
- Information outlining how the City will assist the businesses and their clients understand navigating through/around this project and “business as usual”.
- Accurate timelines for construction, detailed, well positioned road signage for property accesses.

What is the best way to connect with businesses about this project? Which businesses should we connect with?

- A mailout and possibly a virtual meeting to explain the project and gather concerns that need to be addressed. The BA as a whole may have to be contacted. The City suggested 102 Ave as the area for engagement but the BA thinks the impacted stakeholders are on 124 Street as well.

When is the best time to connect with businesses with the understanding that construction probably will not start until 2025 at the earliest?

- Businesses and landowners need to know as soon as possible so they can plan what they will do in the near future. Some may decide to close down when leases expire in advance of construction.

Would a virtual meeting with the Board of Directors be helpful or needed? If so, when?

- Luwam will ask the Board if this is desired/needed.

Would it be possible to get a list of members (address, email, business owner name) who have a business between 124 Street and the 102 Avenue over Groat Road Bridge?

- This is available on the webpage, but not in a list. A comprehensive list may be provided, dependent on Board approval.

Could project information or a link to the City project webpage be posted on your webpage? Are there other opportunities for the City to partner with 124 Street BA to connect with its stakeholders (business owners)?



- This can be considered. More discussions will be required. *The City wants to work closely with the 124 Street BA to provide the information required for a full project understanding by the members and the board. We are happy to continue the discussion.*

Next Steps

- Comments received from this meeting may be considered in the design.
- A preferred option will be provided to the public in late spring 2021 near the end of preliminary design.

The subjects discussed, and decisions reached, are summarized in this document. Please notify the author of any errors or omissions. If comments are not received within 7 days, this record is considered correct.



EDMONTON HISTORICAL BOARD

Prince of Wales Armouries
10440 108 Avenue
Edmonton Alberta T5H 3Z9

Daniel Rose CHAIR
Dominic Schamuhn VICE CHAIR
Neil Cramer
Anna Gibson Hollow
Carrie-Ann Lunde
Nancy MacDonald
Alison McGavigan
James McTague
David Ryning

April 15, 2021

Cyril Balitbit, Program Manager
Infrastructure Planning & Design, Integrated Infrastructure Services
1200 Edmonton Tower, 10111-104 Avenue
Edmonton, AB T5J 0J4

Dear Cyril,

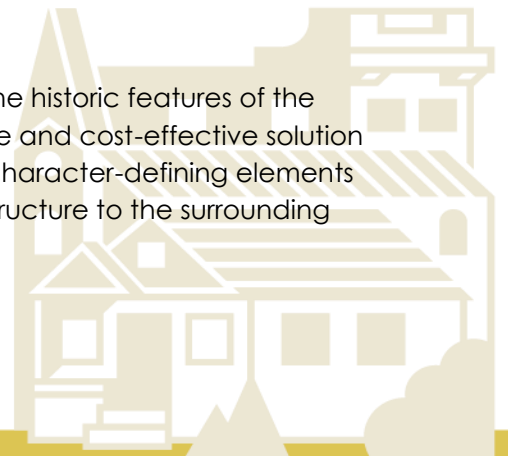
RE: Wellington Bridge Redevelopment

On behalf of the Edmonton Historical Board (EHB), I am pleased to share comments and feedback on the proposed redevelopment of the Wellington Bridge. The EHB is an advisory board for the City Council, providing information and recommendations relating to the conservation of Edmonton's built heritage. Our mandate is to encourage, promote and advocate for the preservation and safeguarding of historical properties, resources, communities and documentary heritage.

The Board was recently made aware of the proposed redevelopment of Wellington Bridge by concerned community members. We have reviewed materials published on the project website and consulted with heritage planners within city administration.

The Wellington Bridge is a significant architectural landmark in Edmonton. As you know the Wellington Bridge was constructed in 1932 as a part of an employment and infrastructure campaign during the Great Depression. It's a rare example of Depression-era construction, and remarkably ornate for a period of significant austerity. The unique style, design and construction of the Wellington Bridge, as well as its unique historical significance were sufficient for the bridge to be included on the Inventory of Historic Resources.

We appreciate the care and diligence taken to preserve the historic features of the Latta and Kinnaird Bridges. We hope that a similarly creative and cost-effective solution can be found for the Wellington Bridge that preserves the character-defining elements of the bridge and reflects the unique historic value of the structure to the surrounding community and city.





EDMONTON HISTORICAL BOARD

Prince of Wales Armouries
10440 108 Avenue
Edmonton Alberta T5H 3Z9

We would encourage any and all effort to preserve character-defining elements including:

Supporting concrete arch

Decorative concrete railings

Moreover, we would encourage considerations of sympathetic materials, style, design and construction in the redesign of the Wellington Bridge, and, where possible, how decorative and interpretive features may be included to demonstrate the history of the bridge and community.

Should you have questions regarding the points above or the historical significance of the Wellington Bridge, we would be pleased to discuss the matter further.

Thank you,

Daniel Rose
Chair, Edmonton Historical Board

CC: Councillor Scott McKeen, Council Advisor



Wellington Bridge Stakeholder and Public Engagement

Preliminary Engineering Summary Report

Background and Context

The Wellington Bridge, located on 102 Avenue between Churchill Crescent and Wellington Crescent, has been slated for replacement as it is reaching the end of its service life. The bridge is currently funded through construction. The preliminary design for this bridge has started and is anticipated to be completed in 2021. Detailed design will follow and construction will be completed in coordination with Valley Line West LRT construction on Stony Plain Road. Construction is anticipated to start between 2025 and 2028.

The Wellington Bridge was originally constructed in 1932 and serves as an arterial roadway with four lanes of traffic, and a sidewalk on each side of the bridge. It is a major link between Edmonton's city centre and communities to the west. The bridge crosses Ramsey Ravine which features a shared use pathway connecting the community of Glenora to the river valley. The bridge is also part of West Central Bike Routes' 102 Avenue Shared Use Pathway (SUP).

Public engagement occurred in 2016 on the SUP. Neighbourhood Renewal occurred in approximately 2012 and the community was extremely interested and influential in the process and ultimate design.

The Wellington Bridge is a highly regarded historic landmark in the community. It is listed in the Register of Historic Resources in Edmonton and Alberta Historic Resources Management Branch. Two of its historic features were identified as being important by the City of Edmonton Heritage Planner: the concrete railings and concrete arches. These components of the bridge may be considered for re-use on the new bridge, or reinterpreted in the new design.

The West Valley Line LRT, currently under procurement, will impact the Wellington Bridge construction timing and level of use. The LRT construction, from downtown to Lewis Farms, is anticipated in 2021 through 2027 and will impact the level of service on Stony Plain Road/104 Avenue. The Stony Plain Road Bridge over Groat Road will be replaced as part of the LRT project with an anticipated construction timeline of three years.

Policies and plans will provide direction for this project. These include, but are not limited to:

- The City Plan (Draft)
- The Way We Move (Transportation Master Plan)
- Edmonton Bike Plan
- Bus Network Redesign
- Breathe
- Policy C593 – Public Engagement Policy

Public Engagement and Communications Plan (PECP)

A PECP was prepared at the beginning of the project and reflected the decision mapping developed by the City of Edmonton for the Request for Proposal. Information sharing is the focus of the plan as most decisions were identified as being technical in nature. Some stakeholder engagement related to gathering local knowledge and preferred bridge experience will occur.

Project Webpage

The Wellington Bridge Replacement webpage (www.edmonton.ca/wellingtonbridge) was added to the City of Edmonton website at the beginning of the project. This was updated when geotechnical drilling occurred in the ravine in September 2020. Further updates will be made as the project progresses.

Information Sharing and Engagement

The identified stakeholders, comprised of several groups/organizations, have a vested interest in the project. Some of these have a greater interest about the historic importance of the bridge and future design, some are more concerned with pedestrian, cycle and vehicular traffic, and others have more interest in the impacts of construction. The stakeholder lists include, but were not limited to:

Internal Stakeholders

- Edmonton Historical Board**
- Alberta Historic Resources Branch
- COE Heritage Resources*
- Edmonton Arts Council (EAC)*
- West Valley LRT Project Team
- Neighbourhood Renewal*
- Urban Form and Corporate Strategic Planning*

Internal stakeholders were approached by the City of Edmonton project manager and meetings were set up as required. The stakeholders met with are marked with an asterisk (*) in the list above. Stakeholders who provided information without a meeting are marked with a double asterisk (**). Records of correspondence and contacts are maintained.

The internal stakeholders were advised about the project intent, timeline and potential outcomes. Knowledge and perspectives about the impacted communities and past projects was sought from the City departments. The EAC was approached to gain an understanding of their process and timelines.

External Stakeholders

- Glenora Community League
- Grosvenor Community League
- Oliver Community League
- Old Glenora Conservation Association*
- Schools: Progressive Academy, St. Vincent Catholic School, Westminster School, Glenora School
- Paths for People*
- Bike Edmonton*

- Edmonton River Valley Conservation Coalition (EVRCC)
- 124 Street Business Association*

An introductory letter via email about the project was sent out to external stakeholders (with the exception of the schools and the EVRCC) on December 18, 2020. The EVRCC was added as a stakeholder in March 2021 and the introductory letter was emailed.

One-on-one meetings were arranged with the groups who indicated an interest after receiving the introductory project letter. They are marked with an asterisk (*) in the list above.

All were advised about the project intent, timeline and potential outcomes in the introductory letter. This information was reiterated in the requested one-on-one virtual meeting held to meet COVID 19 requirements. In addition, their local perspective was collected to help the project team understand opportunities and issues with regards to use, experience, aesthetics and perceived construction issues.

Lines of communication were set up to meet stakeholder needs, keep them updated and position them to provide their perspective when required. Some external stakeholders (such as the schools and community leagues) may act as a conduit for project information to a larger group within the community in the future through the inclusion of project information on their webpages and/or newsletters as the project progresses.

What We Have Heard So Far

A brief summary of each stakeholder meeting follows in chronological order:

Internal Stakeholders:

Urban Form and Corporate Strategic Planning Meeting – August 28, 2020

The meeting intent was to gain knowledge about internal and external stakeholders who will have an interest in the historic/aesthetic aspects of the Wellington Bridge.

Heritage Resources, Edmonton Historical Board, Old Glenora Conservation Association and the Edmonton Arts Council were identified as stakeholders and discussed. The EAC process was outlined.

Historic Resources and Policy Development Meeting- August 31, 2020

The intent of the meeting was to gain an understanding of external stakeholders with an interest in the historic aspects of Wellington Bridge. Heritage Resources works with heritage interest groups.

Policy Development was also invited to the meeting as they are currently working with Old Glenora Conservation Association (OGCA) on the Old Glenora Heritage Character Rezoning project and provided insight into the group: OGCA is a vocal, well-educated group that represents Old Glenora residents (south of Stony Plain Road). They have high influence/ high interest, in particular with the historic character of the bridge.

Neighbourhood Renewal/Building Great Neighbourhoods (BGN) Meeting – September 3, 2020

The intent of the meeting was to gain an understanding of external stakeholders with a community connection/interest in the Wellington Bridge. The Glenora community went through a Neighbourhood Renewal in +/-2012. This program was the precursor to Building Great Neighbourhoods (BGN).

The Glenora community was identified as a highly vested and influential community who had political connections. Lessons learned from the Neighbourhood Renewal project were identified along with suggestions for engagement.

Edmonton Arts Council (EAC) Meeting – November 9, 2020

The intent of the meeting was to gain an understanding of the EAC process and potential for art within the Wellington Bridge Replacement Project. Urban Form liaises between the EAC and City projects and attended the meeting.

The EAC sees the bridge as a location for public art. The EAC process is a 2 stage RFQ process and has been recently revised. The determination of what is included in the calculations is not clearly defined with regards to Growth versus Renewal funds. The City of Edmonton will confirm the process and funds available for art at this location.

Edmonton Historical Board Letter – April 15, 2021

EHB was advised by the community about the bridge project. A letter encouraging the preservation of character defining elements, including the supportive concrete arch and decorative concrete railings was sent to the City project manager. The letter also encouraged sympathetic materials, design and construction.

External Stakeholders:

Bike Edmonton Meeting – January 21, 2021

The intent of the meeting was to introduce the project and gather information on cyclists concerns and needs for safe cycling on and below the bridge. Bike Edmonton represents all cyclists with a focus on bike transportation.

Bike Edmonton provided information on current issues, such as ponding on the road and tight approaches and supported the bridge replacement. Possible detours during construction were also suggested.

Old Glenora Conservation Association Meeting – January 26, 2021

The intent of the meeting was to introduce the project and gather information on local knowledge, bridge use, and user needs. The OGCA focuses on heritage preservation within the Glenora neighbourhood.

The bridge replacement was not supported. The discussion centred on retaining and rehabilitating the existing bridge, which was considered important from an aesthetic and historic perspective. If the bridge could not be rehabilitated, it should be rebuilt with a high level of aesthetics. The condition assessment was requested.

Paths for People Meeting – January 29, 2021

The intent of the meeting is to introduce the project and gather information on local knowledge, bridge use, and user needs.

Paths for People identified the pedestrian experience on the bridge as poor and supported the construction of the bridge with wider pedestrian paths and better approaches. Considerations for improvements to the trail below were also provided.

124 Street Business Association Meeting – February 12, 2021

The intent of the meeting was to introduce the project and gather information on local knowledge, bridge use, and user needs. The City also indicated that they want to work with the BA in engaging with their members.

The BA indicated this was too early to engage with the business stakeholders due to the extended timeline prior to construction. The focus of the local businesses is on the Valley Line LRT construction, which will occur before the replacement of the Wellington Bridge. Concerns originating from the 102 Avenue over Groat Road Bridge closure were also identified.

Next Steps

Information sharing with businesses: Councillor McKeen has requested that the High Street businesses, who will be impacted by the future bridge, be informed about this project in the near future. The timing of this is currently under discussion.

Online information sharing event: Associated Engineering, the project engineers, has made a recommendation for a preferred bridge design to the City of Edmonton as part of the preliminary design report. This recommendation will be provided to City Council in fall/winter 2021 for a decision after the civic election. All identified stakeholders, who were previously contacted, will be updated about the new decision timeline.

An online information sharing event is planned once a decision has been made. An unaddressed mailout, road signs and webpage update will be undertaken to inform the public and stakeholders about the event.

APPENDIX F - PLANNING AND ENVIRONMENT SERVICES SIGN-OFF LETTER



December 1, 2021

Reference No. 407852315-001

To: Cyril Balitbit, City of Edmonton
From: Kyle Payne, Planning and Environment Services
Subject: KP21-60 Wellington Bridge Environmental Impact Assessment -Sign Off

We have completed our review of KP21-60 Wellington Bridge Environmental Impact Assessment Project. This letter confirms that Administration has no further concerns with the proposed development under the North Saskatchewan River Valley Area Redevelopment Plan (NSRV ARP). Please adhere to the following conditions and advisements provided by reviewers.

Comments from Urban Growth and Open Space Strategy (Urban Planning and Environment):

We have reviewed the Wellington Bridge Renewal Environmental Impact Assessment Report and would like to provide our conditional support at this time. Please see our comments below for consideration once the project progresses to the next design stage.

- The EIA report has identified the key environmental issues and well described the biophysical characteristics of the project area. More specifically, the details were provided with wildlife design guideline reference to the proposed design and have considered potential assessments that fulfills the requirements of an EIA terms of reference.
- The EIA report was prepared with consideration of extended impacts that might overlap within the impact footprint of the proposed three separate concepts. Three preliminary designs were also developed to understand the high level impact and potential mitigation options. The outlined mitigation options in general sound reasonable for not but the EIA could explore in detail and verify the proposed measures at the time when the project team settled with one preferred option. Please consider revisiting the proposed mitigation options once the project picks one option with higher level of design consideration. This will provide further opportunity to identify particular mitigation options that could guide the future restoration plan more effectively.
- It was understood that the unnamed creek underneath the Wellington Bridge is currently directed through a corrugated steel pipe culvert. This project is exploring options to daylight this portion of the drainage pipe and integrate this channel with the broader stormwater management plan of the local area. We strongly support this concept and encourage the project team to engage our unit in future discussion.
- There are major erosion and stability concerns within the project area that may not be entirely within the scope of this project but this project could address general erosion issues through proper stormwater management plan. Successful integration of daylighting work will have a positive impact to improve ecological and hydrological connectivity through Ramsy Ravine.

Comments from Infrastructure Planning & Design (Engineering Services):

I reviewed the information provided for this file, including the Environmental Impact Assessment (EIA) prepared by Associated Engineering dated September 2021. Appended to the EIA was a geotechnical report prepared by Thurber Engineering Ltd. (Thurber), File 28874, dated February 04, 2021.



Engineering Services - Geotechnical has been involved with this project, and continues to be involved, providing technical review, support and oversight to the design team. Engineering Services - Geotechnical reviewed the draft version of the appended Thurber report and the comments were incorporated into this final stamped report dated February 04, 2021. As such, we are confident that the geotechnical aspects of the project are being addressed satisfactorily throughout the project stages, and that any geotechnical issues that may arise will also be satisfactorily addressed through on-going support from the Geotechnical Engineer of Record (Thurber) for the project. As such, we have no issues with the project as presented.

Comments from Community and Recreation Facilities (River Valley Parks and Facilities):

Once construction dates have been determined please connect with Braeden Holmstrom to review trail/SUP closure requirements.

Comments from EPCOR Water and Sewer:

The Water and Sewer Servicing Section of EPCOR Water Services has reviewed the proposal and have the following comments:

Wellington Bridge

Our records indicate that no water and/or sewer services exist within the area of the proposal directly off EPCOR mains.

The owner/developer must conform to the requirements of the City of Edmonton Erosion and Sedimentation Control Guidelines and Field Manual.

If you have any questions about this reply, please contact this office at 780-496-5444, or e-mail us at wass.drainage@epcor.com.

Comments from Civic Events and Festivals:

There are 2 annual events that consistently use this roadway. One is the Edmonton Marathon, scheduled for Sunday, August 21, 2022. The second one is the High Street Mile which occurs in early May 2022 (date tbd). Please avoid construction work during these dates.

Comments from Partnership and Event Attraction Strategy:

No concerns or comments

Comments from Urban Forestry:

- Immediate tree conflicts exist within this project on either side of the Wellington Bridge. A site meeting with City of Edmonton Urban Forestry will be required prior to design approval. Please contact North Projects Forester Laurie Lacey with Urban Forestry at 780-868-2174 to schedule an on-site meeting as soon as possible, to review potential tree conflicts and take steps to avoid impacts.
- Please be advised that all costs associated with the removal, replacement or transplanting of trees shall be covered by the applicant as per the Corporate Tree Management Policy (C456C). Should removal or any landscape tree be required, the support of the surrounding community and the area forester is required as per City of Edmonton Live Tree Removal process.
- City of Edmonton Urban Forestry will schedule and carry out all required tree work involved with this project. If tree damage occurs, compensation or value will be enforced and shall be covered by the applicant as per the Corporate Tree Management Policy (C456C).



- Prior to construction or lay-down area acceptance, all City of Edmonton trees within 5 meters of the proposed area shall be protected (hoarded) in such a way warranted by the City of Edmonton's Urban Forester. If tree damage occurs, compensation or value will be enforced and shall be covered by the proponent as per the Corporate Tree Management Policy (C456C).
- During construction or general use of lay-down area, no vehicles or equipment, construction supplies, or debris shall be placed within 5.0 metres of any tree or placed outside the designated fenced area. If construction equipment or material is found outside designated approval area, the proponent is to immediately remove or relocate items back into lay-down yard or costs or penalties will be issued under the Parkland by-law.
- Any soil damage or compaction compromising the trees root system within the parkland space, boulevard, or within the City's ROW buffer green space shall be corrected by and at a cost to the proponent/project. Please be advised that all costs associated with the soil remediation, watering of trees, removal, pruning, replacement, transplanting of trees and tree protection shall be covered by the proponent as per the Corporate Tree Management Policy (C456C).

Comments from EPCOR Drainage

Has EPCOR Drainage Planning and Engineering been consulted on the Drainage design? There are combined sewers in the area that we typically try not to add additional flows to so design would have to be looked at or a drainage analysis would have to be conducted to show that added flows to not have a negative impact on the system.

Comments from Parks and Roads Services (Natural Areas Operations):

- Please update the Corporate Tree Management Policy number to C456C.
- Please be aware that owl and raptor nesting season begins on February 15th and goes till April 15th. Disturbance should be minimized during this time and any vegetation removal will require a nest sweep be completed by a Professional Biologist.
- Please ensure all vegetation mitigation measures are adhered to throughout the length of the project. A Tree Preservation Plan will be required prior to construction and must be submitted when applying for a Tree Permit (the new Public Tree Bylaw will be enacted in spring of 2022). A Tree Removal Plan will need to be included in the preservation plan.
- All landscape plans should be circulated and reviewed prior to approval. Please consider the use of bio-engineering in this area for restoration along the slopes.
- Coordination with naturalareaoperations@edmonton.ca will be required to ensure our maintenance equipment can still use the trail.

General Conditions for vegetation removal:

1. Upon approval of the plan, a site meeting with Natural Areas will be required to review construction plans and tree protection. This meeting will need to be scheduled a minimum of four weeks in advance of the construction start date. This is to review access points, placement of all permanent or temporary construction material required for this project, and to determine tree protection requirements for construction within 5 meters of any City tree or 10 meters from a natural stand. For any vegetation removal, please ensure the area has been clearly staked. Note the laydown area fencing must be installed outside the dripline of any adjacent trees.
2. Please be advised that all costs associated with pruning, removal, tree damage, or replacement shall be covered by the Proponent as per the Corporate Tree Management Policy. Natural Areas will schedule and carry out all required tree work involved with this project. Please contact naturalareaoperations@edmonton.ca to arrange this meeting.



3. Any soil damage or compaction compromising the tree's root system within the parkland space shall be corrected by and at a cost to the Proponent. Please be advised that all costs associated with soil remediation, watering, and tree protection shall be covered by the Proponent as per the Corporate Tree Management Policy.

4. Please note that the removal of vegetation has the opportunity to impact birds and bird habitat. Protection of migratory and non-migratory birds is legislated federally and provincially and enforceable regardless of whether or not individual environmental reviews conducted in accordance with the River Valley Bylaw include discussions of these topics. The onus is on the individual or company conducting habitat disturbance or construction activities to ensure that due diligence has been exercised to avoid harm to migratory and non-migratory birds. Individuals or companies that do not avoid harm to most wildlife species risk prosecution under the Wildlife Act and, in some cases, the Species at Risk Act. In the case of migratory birds, prosecution under the Migratory Birds Convention Act is also possible.

Comments from Parks and Roads Services (Resource Planning and Land Development):

1. A pre-construction inspection to areas that impact parkland prior to accessing the site and a post-construction inspection once parkland restoration has occurred will be conducted by Land Development. Email: parkslandscapeinventory@edmonton.ca to request inspections.
2. Project must be reviewed by Natural Areas Operations.
3. This project must follow all City Policies and Servicing Agreements.
4. The site is in compliance with the site's Natural Area Management Plan.
5. Impacts to vegetation may require biological surveys such as rare plant surveys, breeding bird surveys, etc. These surveys must be completed within the appropriate time frame and with consideration to seasonality and construction timelines.
6. Erosion and Sedimentation Control Measures must be in place prior to any construction activity to prevent any contaminants from entering Infrastructure or water bodies.
7. Any lay down, staging or haul route area on Parkland must be approved and fenced, with no vehicular or project activity outside of the fenced area. There should be no access to the lay down, staging or haul route area to ensure public safety. The restoration of the entire area must be repaired to the existing turf/natural conditions. Soil compaction protection, aeration and re-sodding; including the maintenance (eg watering, mowing and weed control) of restored areas will be the responsibility of the proponent until the area is established and accepted by PARS. Email: parkslandscapeinventory@edmonton.ca to request a laydown area approval site meeting.
8. All damaged maintained turf areas shall be re-sodded (not topdress and seed) and the maintenance (watering, mowing, public access control, etc) of all restored turf areas will be the responsibility of the proponent until the turf is established and accepted by PARS. There should be no access to the construction areas to ensure public safety.
9. All damages to natural areas must be repaired with approved natural grass seed mixtures and natural plantings/vegetation as per current Landscape Construction Standards and the maintenance (watering, weed control, public access control, etc) of restored natural areas will be the responsibility of the proponent until the natural area planting material is established. All other damages to parkland inventory must be restored to pre-existing conditions and COE Construction Standards and City Operations and PARS satisfaction.
10. The contractor is solely responsible for securing the site at all times. There should be no access to the construction, lay down, staging or haul route areas to ensure public safety.
11. Site drainage must not be affected by this project. Any overland drainage issue that is a result of this project will be corrected and repaired by the proponent/developer/contractor and to the final acceptance by PARS.
12. Erosion Control Measures must be in place post construction to prevent overland drainage washout on areas that have been newly landscaped (e.g. slopes, trails, etc).



13. Public access control measures must be in place post construction to prevent the public from accessing areas that have been newly landscaped (e.g. slopes, trails, paths, sides of stairs, etc).
14. Any trail closures shall adhere to the City's Trail Closure Procedures. All trail closure activities must be approved through River Valley Operations prior to construction and closure of trails. This shall be done a minimum of two weeks in advance of planned construction.
15. Any new trail construction or rehabilitation must meet current City of Edmonton trail construction standards and should have a minimum 1M buffer zone, free of vegetation on either side of the trail.
16. There is no dumping or stockpiling on the site.
17. Use of this area must be managed carefully to prevent any spills or release of contaminants.
18. Any holes should be filled immediately to ensure public safety. This includes mitigating future trip hazards from settlement.
19. Noxious weed control shall be managed as required within any fenced or construction area in the scope of this project and will be the responsibility of the proponent during construction in accordance with the Weed Control Act.
20. The developer/contractor is responsible for all maintenance and weed control programs on this site and/or lay down, haul route areas during construction and until the entire site has been given final acceptance by PARS
21. If tree conflicts (work within 5m of a tree) are anticipated, or arise during construction, or a tree is within 3m of the haul route a site meeting with the City of Edmonton Natural Area Forester will be required. Please be advised that all costs associated with the removal, replacement or transplanting of trees shall be covered by the applicant as per the Corporate Tree Management Policy (C456C). The City of Edmonton will schedule and carry out all required tree work involved with this project.
22. Tree protection is required around existing boulevard trees near the site access points. A minimum 2M protection barrier surrounding each tree is required.
23. The site is left in an intended state that meets the City's satisfaction.
24. Please follow The City of Edmonton Landscape Design and Construction Standards Volume 5 – Landscaping when designing any new landscape for this area.
25. For projects longer than one day, signage must be posted indicating a project contact person and phone number for inquiries.

General Conditions:

1. All mitigation measures and commitments outlined by City reviewers must be incorporated into the construction work plan.
2. The proponent is responsible for seeking approval for any other regulatory permits from provincial and federal agencies.
3. Please contact the Neighbourhood Resource Coordinator Darrell Bordell at 780-944-5424) in the area to ensure appropriate community notification.
4. For potential impacts to City parks and facilities:
 - a. Hard surface access/haul routes are preferred.
 - b. Please ensure restoration of the site occurs and meets existing site conditions. All damages to parkland must be restored to City of Edmonton Construction Standards and City Operations' satisfaction.
 - c. Noxious weeds shall be managed and controlled as required within any fenced area and should be the responsibility of the contractor/department during construction.
 - d. Signage must be posted indicating a project contact person and phone number for inquiries.



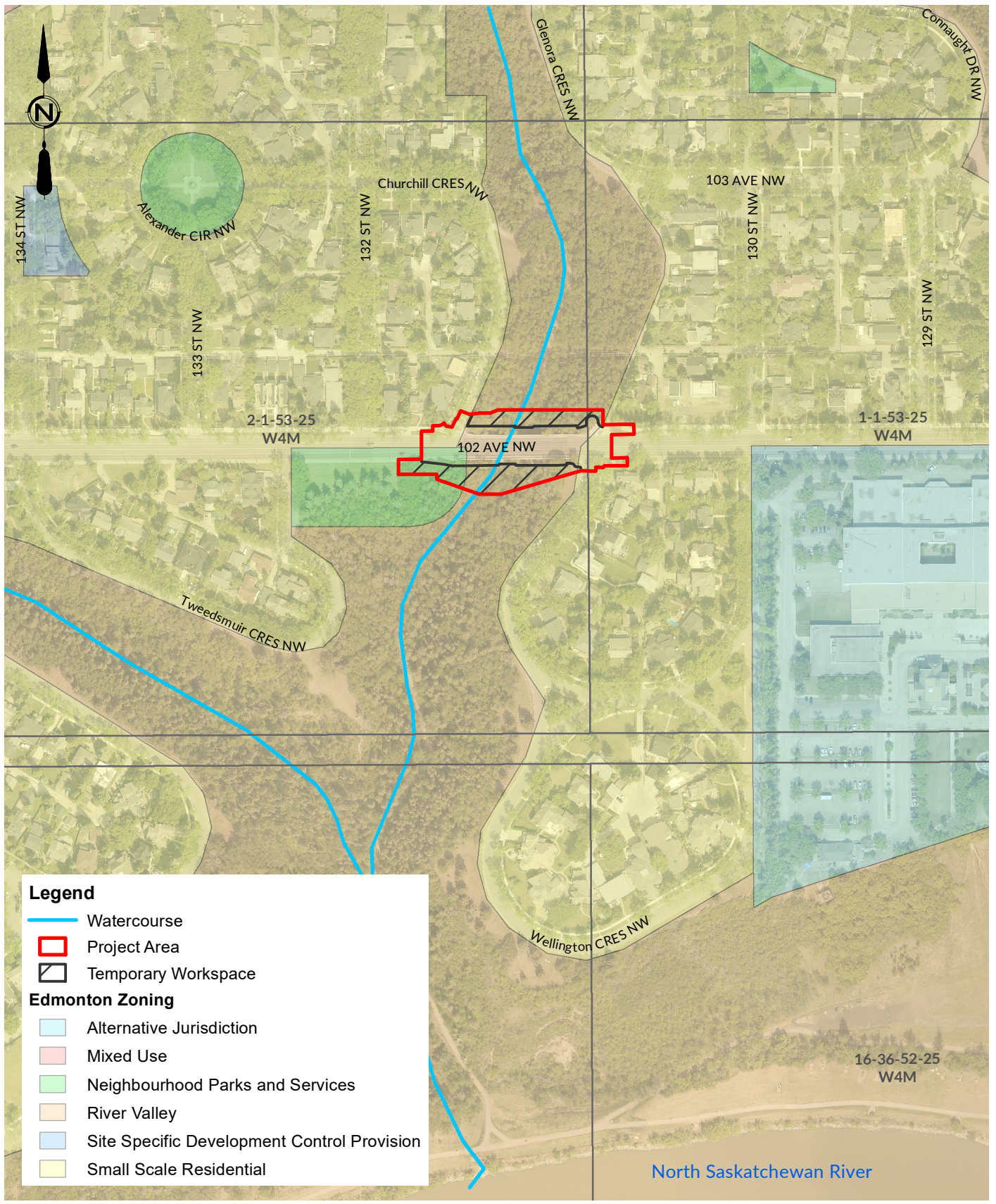
5. All trail closures shall adhere to the City's Trail Closure Procedures. All trail closure activities must be approved through River Valley Operations prior to construction and closure of trails. Please contact **Braeden Holmstrom** (Team Leader, River Valley & Horticulture) at **587-986-2841** or **braeden.holmstrom@edmonton.ca** to obtain the necessary trail closure approvals. This shall be done a minimum of two weeks in advance of planned construction.
6. Please attach this letter for any further City of Edmonton approvals.

Should you have any questions or concerns, please contact me by e-mail or by phone at 780-496-6397.

Regards,

Kyle Payne

APPENDIX B – UPDATED FIGURES



SAVE DATE: 2024-05-14 9:04:01 AM SAVED BY:
DRAWING PATH: D:\2020-3858_eia\EA_Reporting\1-1_ProjectOverviewZoning.mxd
DATA SOURCE: .

Legend

- Watercourse
- Project Area
- Temporary Workspace

Edmonton Zoning

- Alternative Jurisdiction
- Mixed Use
- Neighbourhood Parks and Services
- River Valley
- Site Specific Development Control Provision
- Small Scale Residential

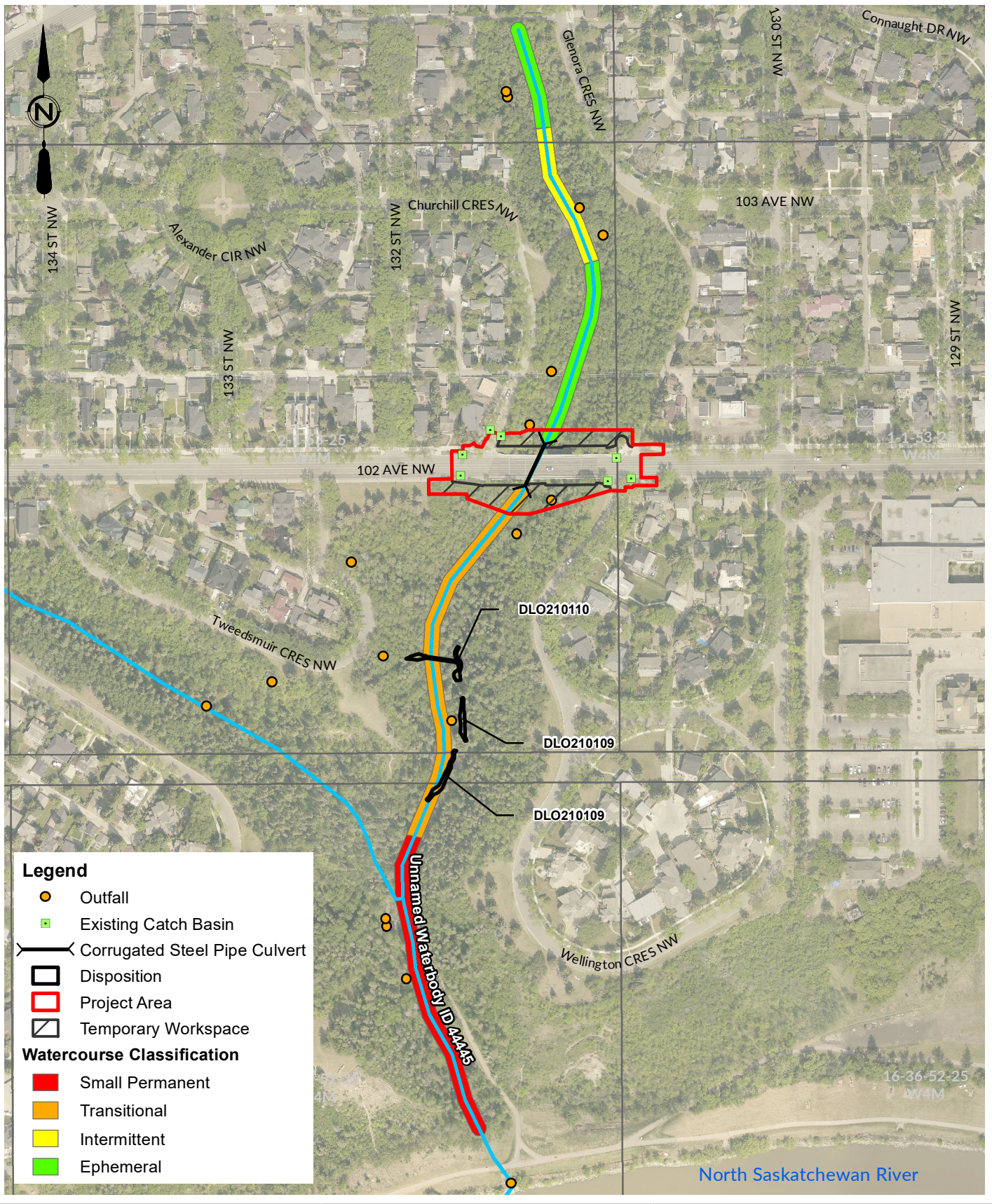
North Saskatchewan River



AE PROJECT No. 2020-3858
SCALE 1:3,500
APPROVED
DATE 2024MAY15
REV
DESCRIPTION ISSUED FOR REPORT

FIGURE 1

CITY OF EDMONTON
 WELLINGTON BRIDGE REPLACEMENT
 PROJECT OVERVIEW AND ZONING



SAVE DATE: 2024-05-14 9:00:17 AM SAVED BY:
DRAWING PATH: D:\2020-3858_eia\EA_Reporting\3-2_SurfaceWater.mxd
DATA SOURCE: .

Legend

- Outfall
- Existing Catch Basin
- Corrugated Steel Pipe Culvert
- Disposition
- Project Area
- Temporary Workspace

Watercourse Classification

- Small Permanent
- Transitional
- Intermittent
- Ephemeral

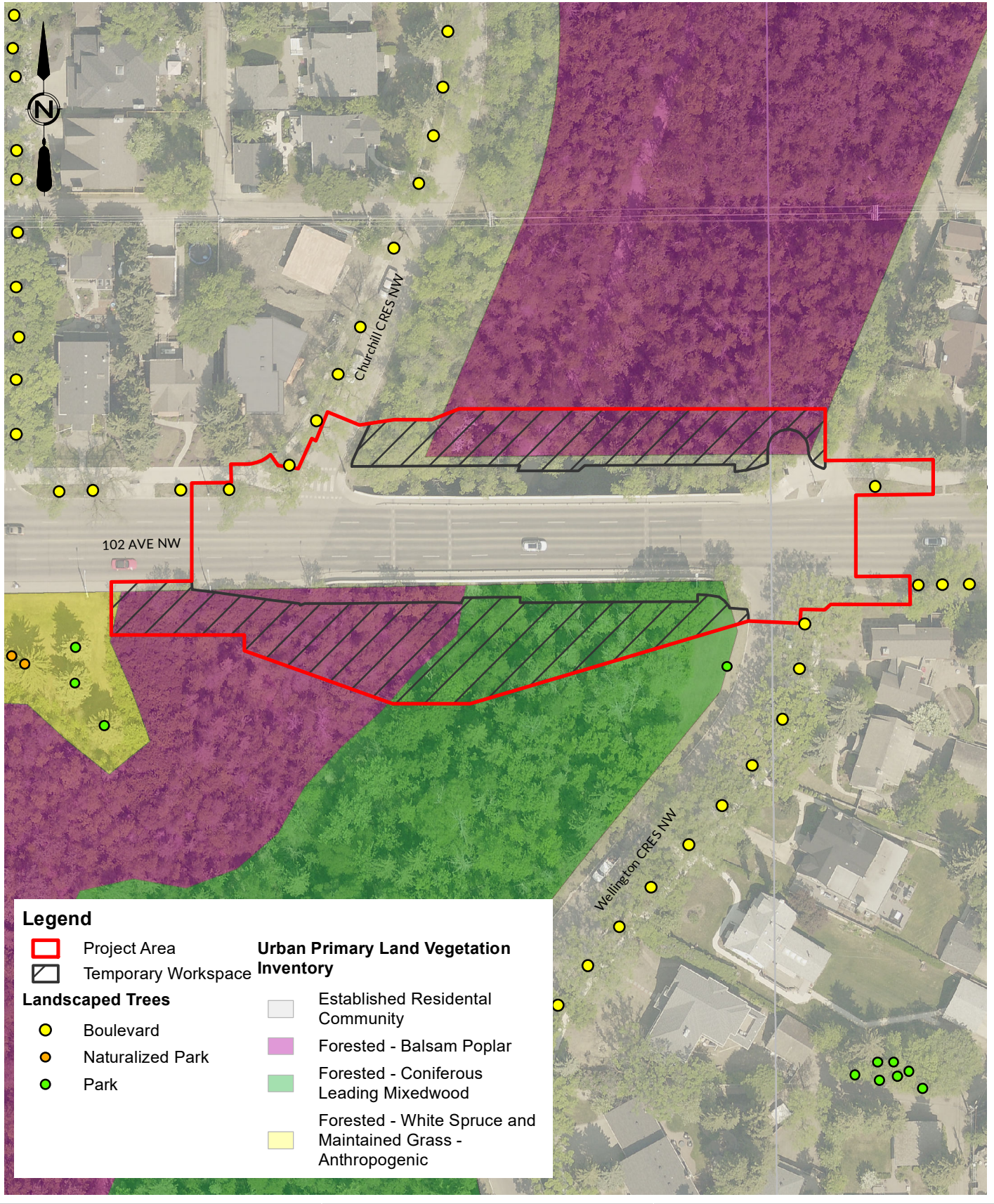
Associated Engineering

BEST MANAGED COMPANIES
Platinum member

0 50 100 Meters

AE PROJECT No.	2020-3858
SCALE	1:3,500
APPROVED	
DATE	2024MAY15
REV	
DESCRIPTION	ISSUED FOR REPORT

FIGURE 2
CITY OF EDMONTON
WELLINGTON BRIDGE REPLACEMENT
SURFACE WATER



Legend

Project Area

Temporary Workspace

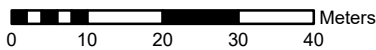
Urban Primary Land Vegetation Inventory

Landscaped Trees

- Boulevard
- Naturalized Park
- Park

- Established Residential Community
- Forested - Balsam Poplar
- Forested - Coniferous Leading Mixedwood
- Forested - White Spruce and Maintained Grass - Anthropogenic

SAVE DATE: 2024-05-14 9:03:36 AM SAVED BY:
DRAWING PATH: D:\2020-3858_eia\EA_Reporting\3-4_Vegetation.mxd
DATA SOURCE: .

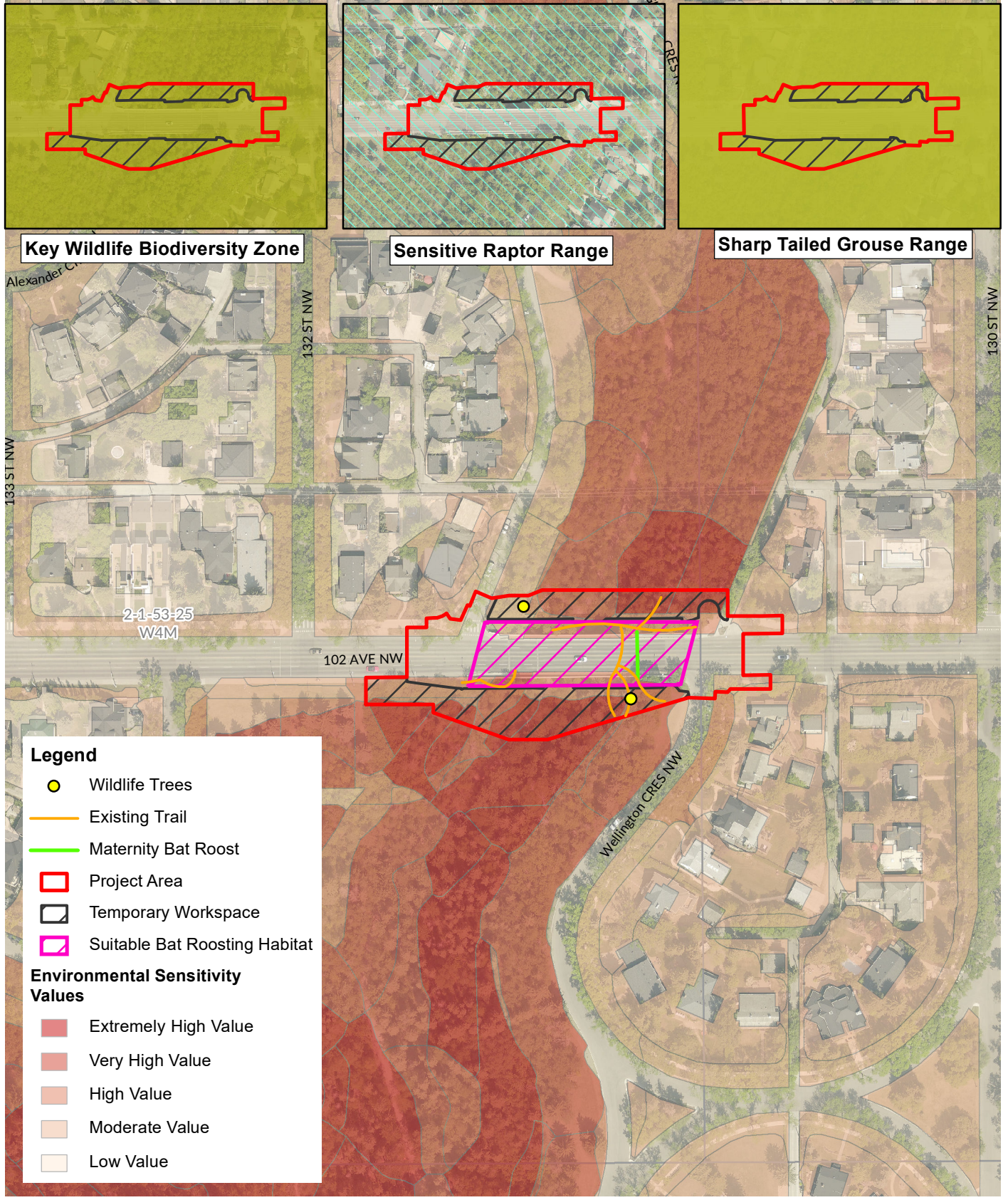


AE PROJECT No. 2020-3858
SCALE 1:1,000
APPROVED
DATE 2024MAY15
REV
DESCRIPTION ISSUED FOR REPORT

FIGURE 3

CITY OF EDMONTON
WELLINGTON BRIDGE REPLACEMENT

VEGETATION



SAVE DATE: 2024-05-15 9:07:00 AM SAVED BY:
DRAWING PATH: D:\2020-3858_eia\EA_Reporting\3-5_Wildlife.mxd
DATA SOURCE: .

Legend

- Wildlife Trees
- Existing Trail
- Maternity Bat Roost
- Project Area
- Temporary Workspace
- Suitable Bat Roosting Habitat

Environmental Sensitivity Values

- Extremely High Value
- Very High Value
- High Value
- Moderate Value
- Low Value

AE PROJECT No.	2020-3858
SCALE	1:2,000
APPROVED	
DATE	2024MAY15
REV	
DESCRIPTION	ISSUED FOR REPORT

FIGURE 4
CITY OF EDMONTON
WELLINGTON BRIDGE REPLACEMENT
WILDLIFE

Achyut Adhikari

APPENDIX C – HAZARDOUS BUILDING MATERIALS TESTING REPORT



THURBER ENGINEERING LTD.

Hazardous Building Material Testing

Wellington Bridge Replacement Project
102 Avenue East of 132 Street NW
Edmonton, Alberta

Client Name: Associated Engineering Alberta Ltd.

Date: April 16, 2024

File: 28874.220



TABLE OF CONTENTS

1.	INTRODUCTION.....	1
2.	SCOPE OF WORK	1
3.	HAZARDOUS BUILDING MATERIAL TESTING	1
4.	GUIDELINES / ASSESSMENT SOURCES	2
5.	ANALYTICAL RESULTS.....	2
5.1	Lead	2
5.2	Asbestos.....	2
5.3	PCBs, Mercury, CFCs and Radioactive Materials.....	3
6.	CONCLUSIONS	3
7.	CLOSURE.....	4

STATEMENT OF LIMITATIONS AND CONDITIONS

APPENDICES

APPENDIX A

Drawing

APPENDIX B

Table 5.1

HBMT Chemical Analyses

1. INTRODUCTION

Thurber Engineering Ltd. (Thurber) was retained by Associated Engineering Alberta Ltd. (AEAL) to conduct Hazardous Building Material Testing (HBMT) on the Wellington Bridge along 102 Avenue, east of 132 Street NW in Edmonton, Alberta (the “Site”). The Site does not have a municipal address but consists of a four lane concrete bridge that carries 102 Avenue traffic across the Ramsay Ravine. The Site is shown on Drawing 39888-1 in Appendix A.

Authorization to proceed with the HBMT was provided by Mr. Chris Prya, P.Eng., MBA, of AEAL.

It is a condition of this report that Thurber’s performance of its professional services is subject to the attached Statement of Limitations and Conditions.

2. SCOPE OF WORK

The general scope of work for the supplemental HBMT is outlined in Thurber’s March 13, 2024, proposal. The scope of work for the supplemental HBMT generally consisted of:

- Mobilize Thurber personnel to the Site.
- Obtain and submit samples of selected building materials for asbestos and lead paint analyses.
- Observe fluorescent light ballasts and structure features for the identification of potential sources of polychlorinated biphenyls (PCBs), mercury, chlorofluorocarbons (CFCs) and radioactive materials.
- Compare results to provincial or federal guidelines.
- Prepare a report.

The number of samples was to be dependent on the features found on Site.

3. HAZARDOUS BUILDING MATERIAL TESTING

On April 2, 2024, Mr. Michael Halliwell, P.Eng., of Thurber, conducted the HBMT at the Site. The HBMT included collection of representative paint and building materials samples for subsequent lead paint and bulk asbestos analyses. The sample locations included full depth paint samples at location of visible paints and materials that commonly contain asbestos.

A total of 14 samples, including seven for lead paint and seven potential asbestos containing materials (such as concrete and caulking), plus two duplicates, were collected. Samples were placed into laboratory supplied plastic bags and stored in a cooler for delivery to Eurofins Enviro-Works (Eurofins) for chemical analyses.

Structure features were observed; however, no fluorescent lighting, high-intensity discharge lamps, HVAC systems, piping or other potential sources of PCBs, CFCs, mercury or radioactive materials were present.

4. GUIDELINES / ASSESSMENT SOURCES

The guidelines and assessment sources used to evaluate samples from Site are outlined below:

- Government of Canada, 2016 (as amended). “Surface Coating Materials Regulation” (SCMR, for lead paint assessment).
- Government of Alberta, 2019. “Alberta Asbestos Abatement Manual” (AAAM, for asbestos assessment).

5. ANALYTICAL RESULTS

5.1 Lead

Based on the Eurofins lead test results, as presented in Table 5.1 in Appendix B, all paint samples met the SCMR guideline (90 mg/kg). In general, the paint observed on the bridge was quite weathered, with the paint on bridge deck areas fairly well adhered and in overall fair condition. Areas along the paved trail below the bridge have been repeatedly graffitied and painted over, resulting in very thick coatings of weathered, poorly adhered paint (generally poor condition). Details of Eurofins lead paint analyses are included in Appendix B.

5.2 Asbestos

The Eurofins asbestos analyses, as summarized in Table 5.1, identified no detectable asbestos in any of the samples submitted. The analytical results and date of bridge construction (1932 is stamped into the west abutment), suggests that the bridge was installed after the period of widespread historical use of asbestos concrete, but prior to common use in other construction products. Details of Eurofins asbestos analyses are included in Appendix B.



5.3 PCBs, Mercury, CFCs and Radioactive Materials

Visual observations during the HBMT did not identify transformers, lamps with ballasts, fluorescent light tubes, batteries, smoke detectors or other features on Site that would be potential sources of PCBs, mercury, CFCs or radioactive materials.

6. CONCLUSIONS

Sampling of the bridge structure and visible paint did not identify asbestos or lead paint at the Wellington Bridge. Common sources of PCBs, mercury, CFCs and radioactive materials were not observed on Site at the time of the HBMT sampling. Additional HBMT sampling is not warranted at this time.

However, proper precautions should be in place to protect workers from other potential hazards that may be encountered during the project (i.e. silica) and if suspect materials are encountered within the structure during bridge deconstruction (i.e. hidden cementitious conduit materials), they should be tested to confirm their status.



THURBER ENGINEERING LTD.

7. CLOSURE

We trust this information meets your present needs. If you have any questions, please contact the undersigned at your convenience.

Michael Halliwell, M.Eng., EP, P. Eng.
Senior Environmental Engineer

Date: April 16, 2024
File: 28874.220

Craig Campbell, M.Eng., P. Eng.
Review Partner



STATEMENT OF LIMITATIONS AND CONDITIONS

1. STANDARD OF CARE

This Report has been prepared in accordance with generally accepted engineering or environmental consulting practices in the applicable jurisdiction. No other warranty, expressed or implied, is intended or made.

2. COMPLETE REPORT

All documents, records, data and files, whether electronic or otherwise, generated as part of this assignment are a part of the Report, which is of a summary nature and is not intended to stand alone without reference to the instructions given to Thurber by the Client, communications between Thurber and the Client, and any other reports, proposals or documents prepared by Thurber for the Client relative to the specific site described herein, all of which together constitute the Report.

IN ORDER TO PROPERLY UNDERSTAND THE SUGGESTIONS, RECOMMENDATIONS AND OPINIONS EXPRESSED HEREIN, REFERENCE MUST BE MADE TO THE WHOLE OF THE REPORT. THURBER IS NOT RESPONSIBLE FOR USE BY ANY PARTY OF PORTIONS OF THE REPORT WITHOUT REFERENCE TO THE WHOLE REPORT.

3. BASIS OF REPORT

The Report has been prepared for the specific site, development, design objectives and purposes that were described to Thurber by the Client. The applicability and reliability of any of the findings, recommendations, suggestions, or opinions expressed in the Report, subject to the limitations provided herein, are only valid to the extent that the Report expressly addresses proposed development, design objectives and purposes, and then only to the extent that there has been no material alteration to or variation from any of the said descriptions provided to Thurber, unless Thurber is specifically requested by the Client to review and revise the Report in light of such alteration or variation.

4. USE OF THE REPORT

The information and opinions expressed in the Report, or any document forming part of the Report, are for the sole benefit of the Client. NO OTHER PARTY MAY USE OR RELY UPON THE REPORT OR ANY PORTION THEREOF WITHOUT THURBER'S WRITTEN CONSENT AND SUCH USE SHALL BE ON SUCH TERMS AND CONDITIONS AS THURBER MAY EXPRESSLY APPROVE. Ownership in and copyright for the contents of the Report belong to Thurber. Any use which a third party makes of the Report, is the sole responsibility of such third party. Thurber accepts no responsibility whatsoever for damages suffered by any third party resulting from use of the Report without Thurber's express written permission.

5. INTERPRETATION OF THE REPORT

- a) Nature and Exactness of Soil and Contaminant Description: Classification and identification of soils, rocks, geological units, contaminant materials and quantities have been based on investigations performed in accordance with the standards set out in Paragraph 1. Classification and identification of these factors are judgmental in nature. Comprehensive sampling and testing programs implemented with the appropriate equipment by experienced personnel may fail to locate some conditions. All investigations utilizing the standards of Paragraph 1 will involve an inherent risk that some conditions will not be detected and all documents or records summarizing such investigations will be based on assumptions of what exists between the actual points sampled. Actual conditions may vary significantly between the points investigated and the Client and all other persons making use of such documents or records with our express written consent should be aware of this risk and the Report is delivered subject to the express condition that such risk is accepted by the Client and such other persons. Some conditions are subject to change over time and those making use of the Report should be aware of this possibility and understand that the Report only presents the conditions at the sampled points at the time of sampling. If special concerns exist, or the Client has special considerations or requirements, the Client should disclose them so that additional or special investigations may be undertaken which would not otherwise be within the scope of investigations made for the purposes of the Report.
- b) Reliance on Provided Information: The evaluation and conclusions contained in the Report have been prepared on the basis of conditions in evidence at the time of site inspections and on the basis of information provided to Thurber. Thurber has relied in good faith upon representations, information and instructions provided by the Client and others concerning the site. Accordingly, Thurber does not accept responsibility for any deficiency, misstatement or inaccuracy contained in the Report as a result of misstatements, omissions, misrepresentations, or fraudulent acts of the Client or other persons providing information relied on by Thurber. Thurber is entitled to rely on such representations, information and instructions and is not required to carry out investigations to determine the truth or accuracy of such representations, information and instructions.
- c) Design Services: The Report may form part of design and construction documents for information purposes even though it may have been issued prior to final design being completed. Thurber should be retained to review final design, project plans and related documents prior to construction to confirm that they are consistent with the intent of the Report. Any differences that may exist between the Report's recommendations and the final design detailed in the contract documents should be reported to Thurber immediately so that Thurber can address potential conflicts.
- d) Construction Services: During construction Thurber should be retained to provide field reviews. Field reviews consist of performing sufficient and timely observations of encountered conditions in order to confirm and document that the site conditions do not materially differ from those interpreted conditions considered in the preparation of the report. Adequate field reviews are necessary for Thurber to provide letters of assurance, in accordance with the requirements of many regulatory authorities.

6. RELEASE OF POLLUTANTS OR HAZARDOUS SUBSTANCES

Geotechnical engineering and environmental consulting projects often have the potential to encounter pollutants or hazardous substances and the potential to cause the escape, release or dispersal of those substances. Thurber shall have no liability to the Client under any circumstances, for the escape, release or dispersal of pollutants or hazardous substances, unless such pollutants or hazardous substances have been specifically and accurately identified to Thurber by the Client prior to the commencement of Thurber's professional services.

7. INDEPENDENT JUDGEMENTS OF CLIENT

The information, interpretations and conclusions in the Report are based on Thurber's interpretation of conditions revealed through limited investigation conducted within a defined scope of services. Thurber does not accept responsibility for independent conclusions, interpretations, interpolations and/or decisions of the Client, or others who may come into possession of the Report, or any part thereof, which may be based on information contained in the Report. This restriction of liability includes but is not limited to decisions made to develop, purchase or sell land.

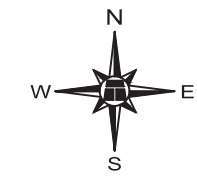
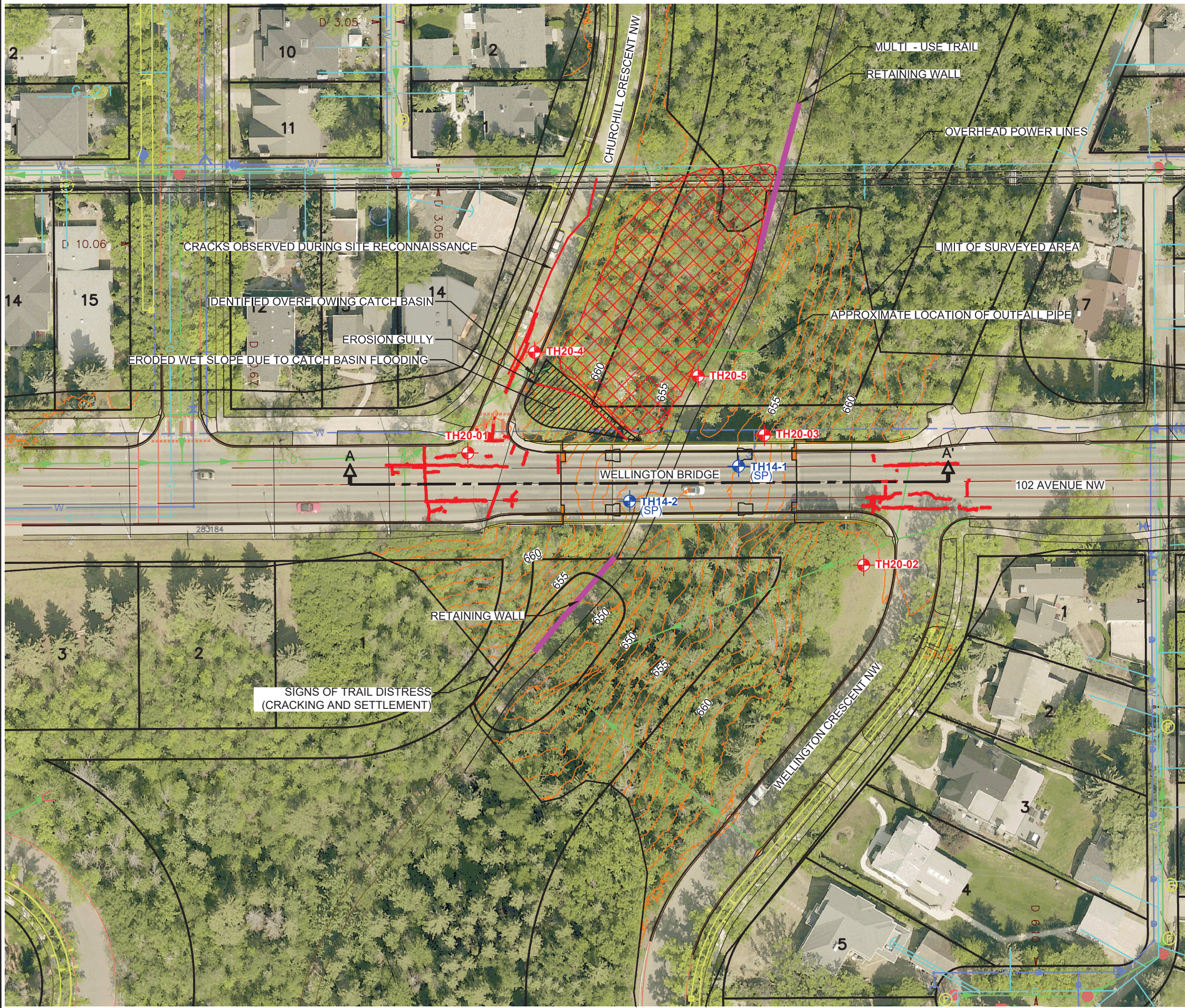


THURBER ENGINEERING LTD.








APPENDIX A

Drawing

H:\288000\28874 Wellington Bridge Replacement\Drafting\28874-1 FEB 1, 2021.dwg - 1 - Feb. 01, 2021



LEGEND

-  APPROXIMATE TEST HOLE LOCATION (2020)
-  APPROXIMATE TEST HOLE LOCATION (2014)
-  STANDPIPE PIEZOMETER
-  CRACK
-  GROUND SURFACE CONTOUR (CONTOUR INTERVAL = 1m)
-  OVERHEAD POWER LINE
-  LANDSLIDES IN ADVANCE STAGE: CRACKS AND SLIDE SURFACE DEVELOPED. LANDSLIDES ARE IN DORMANT OR SLOW MOVEMENT CONDITION. POTENTIALLY ACTIVE LANDSLIDES.



2019 AIR PHOTO FROM THE CITY OF EDMONTON



WELLINGTON BRIDGE REPLACEMENT

SITE PLAN SHOWING APPROXIMATE TEST HOLE LOCATIONS

DWG No. 28874-1

DRAWN BY	ML
DESIGNED BY	SEC
APPROVED BY	TSA
SCALE	1:800
DATE	FEBRUARY 2021
FILE No.	28874











THURBER ENGINEERING LTD.

APPENDIX B

Table 5.1
HBMT Chemical Analyses

TABLE 5.1 - Wellington Bridge HBM Results
102 Avenue East of 132 Street NW, Edmonton, Alberta

Sample Date: 02 April 2024
 Job #: 28874
 Sampled By: MFH

Sample No.	Location	Description	Area / Quantity	Ease of Sampling, Status, Friability	Photo?	Lead (Guideline 90 mg/kg)	Asbestos
1	E. Abutment	Graffiti and covering paint	~75 m ²	Weathered, thick (many layers), cracking, easy to sample		<21.1	
2	NE Pier	Graffiti and covering paint	~40 m ²	Weathered, thick (many layers), cracking, easy to sample		<21.0	
3	NW Pier	Graffiti and covering paint	~40 m ²	Weathered, thick (many layers), cracking, easy to sample		<23.5	
4	W Abutment	Graffiti and covering paint	~75 m ²	Weathered, thick (many layers), cracking, easy to sample		<23.1	
5	SE Pier	Graffiti and covering paint	~40 m ²	Weathered, thick (many layers), cracking, easy to sample		<22.2	
6 & Dup 1	SW Pier	Graffiti and covering paint	~40 m ²	Weathered, thick (many layers), cracking, easy to sample		<23.3 / <22.87	
7	W. Abutment	Concrete material (typical)	Entire structure	Variable condition, some area quite weathered / degraded, non-friable			N.D.
8	SW Pier	Concrete material (typical)	Entire structure	Variable condition, some area quite weathered / degraded, non-friable			N.D.
9	Main Deck	Light brown / cream colored paint (typical)	All painted areas of deck	Weathered, cracking in places, generally well adhered.		<22.8	
10	Main Deck	Concrete material (typical, sample from north side)	Main deck	Generally good condition, non-friable			N.D.
11 / Dup 2	Main Deck	Caulking between joints (i.e. on "handrail")	Limited quantity	Weathered, generally good condition, non-friable			N.D. / N.D.
12	Main Deck	Baulstrade material	Portions of both sides of main deck	Generally good condition, non-friable			N.D.
13	Main Deck	Concrete "footer" at NW corner (typical of newer concrete added at abutments)	Limited quantity	Variable condition, some area quite weathered / degraded, non-friable			N.D.
14	Main Deck	Second concrete material sample (south side)	Main deck	Generally good condition, non-friable	---		N.D.

Certificate of Analysis

Client: Thurber Engineering Ltd.
 4127 Roper Road NW
 Edmonton, AB T6B 3S5

Date Submitted: 4/2/2024
Date Completed: 4/5/2024

Lab ID: 24040270
COC No.: 128903
Project: 28874
Contact: Michael Halliwell
Analyst: cpotolicki

Method: ASTM E1645-16 (prep) and ASTM E3193-20 (analysis) - Lead Paint by FAAS

Sample ID	Date Sampled	Description	Lead (mg/kg)	Qualifier
24040270-001	4/2/2024	Sample 1	< 21.1	
24040270-002	4/2/2024	Sample 2	< 21.0	
24040270-003	4/2/2024	Sample 3	< 23.5	
24040270-004	4/2/2024	Sample 4	< 23.1	
24040270-005	4/2/2024	Sample 5	< 22.2	
24040270-006	4/2/2024	Sample 6	< 23.3	
24040270-007	4/2/2024	Sample 9	< 22.8	
24040270-008	4/2/2024	Dup 1	< 22.7	

Eurofins Enviro-Works Inc. is a proficient member of the AIHA ELPAT quality control program. Samples will be stored for 60 days after they are submitted. Eurofins Enviro-Works Inc. is not responsible for the procedures used during sample collection. Eurofins Enviro-Works Inc. is not responsible for any consultation, interpretation or course of action taken with respect to these results. Eurofins Enviro-Works Inc. privacy policy includes the limitation of access or discussion of these results to include only the client listed in the report.



Approved By:



Ann-Marie Kalman, B.Sc.
 Lab Manager

Certificate of Analysis

Client:	Thurber Engineering Ltd. 4127 Roper Road NW Edmonton, AB T6B 3S5	Lab ID : 24040269 COC No. 128903 Project: 28874
Date Submitted:	02-Apr-24	Contact: Michael Halliwell
Date Completed:	11-Apr-24	

Bulk Asbestos Fiber Analysis by Polarized Light Microscopy (PLM) NIOSH 9002

Sample No.	Date Sampled	Client Sample Description	Sample Type	Asbestos Type and Content	Non-Asbestos Constituents
24040269-001	2024-04-02	Sample 7	Cementitious Mix, Grey/Brown	None Detected	Other
24040269-002	2024-04-02	Sample 8	Cementitious Mix, Grey/Brown	None Detected	Other
24040269-003	2024-04-02	Sample 10	Cementitious Mix, White	None Detected	Other
24040269-004	2024-04-02	Sample 11	Putty, Grey/Brown	None Detected	Other
24040269-005	2024-04-02	Sample 12	Cementitious Mix, Grey	None Detected	Other
24040269-006	2024-04-02	Sample 13	Cementitious Mix, Grey	None Detected	Other
24040269-007	2024-04-02	Sample 14	Cementitious Mix, Grey/Brown	None Detected	Other
24040269-008	2024-04-02	Dup 2	Putty, Grey/Brown	None Detected	Other

* = Trace amounts detected; Below replicable detection limit

Eurofins Enviro-Works Inc. is accredited by CALA to ISO/IEC 17025. For scope of accreditation visit www.enviro-works.com. Samples will be stored for 60 days after they are submitted. This analytical report reflects only the results of the materials tested. Eurofins Enviro-Works Inc. is not responsible for the procedures used during sample collection. Eurofins Enviro-Works Inc. is not responsible for any consultation, interpretation or course of action taken with respect to these results. Please be aware that TEM is recommended for any cementitious material, and/or vermiculite matrix that are determined after analysis to be non-detected, as trace amounts of asbestos may be below the resolution of a PLM. Eurofins Enviro-Works Inc. privacy policy includes the limitation of access or discussion of these results to include only the client listed in the report.

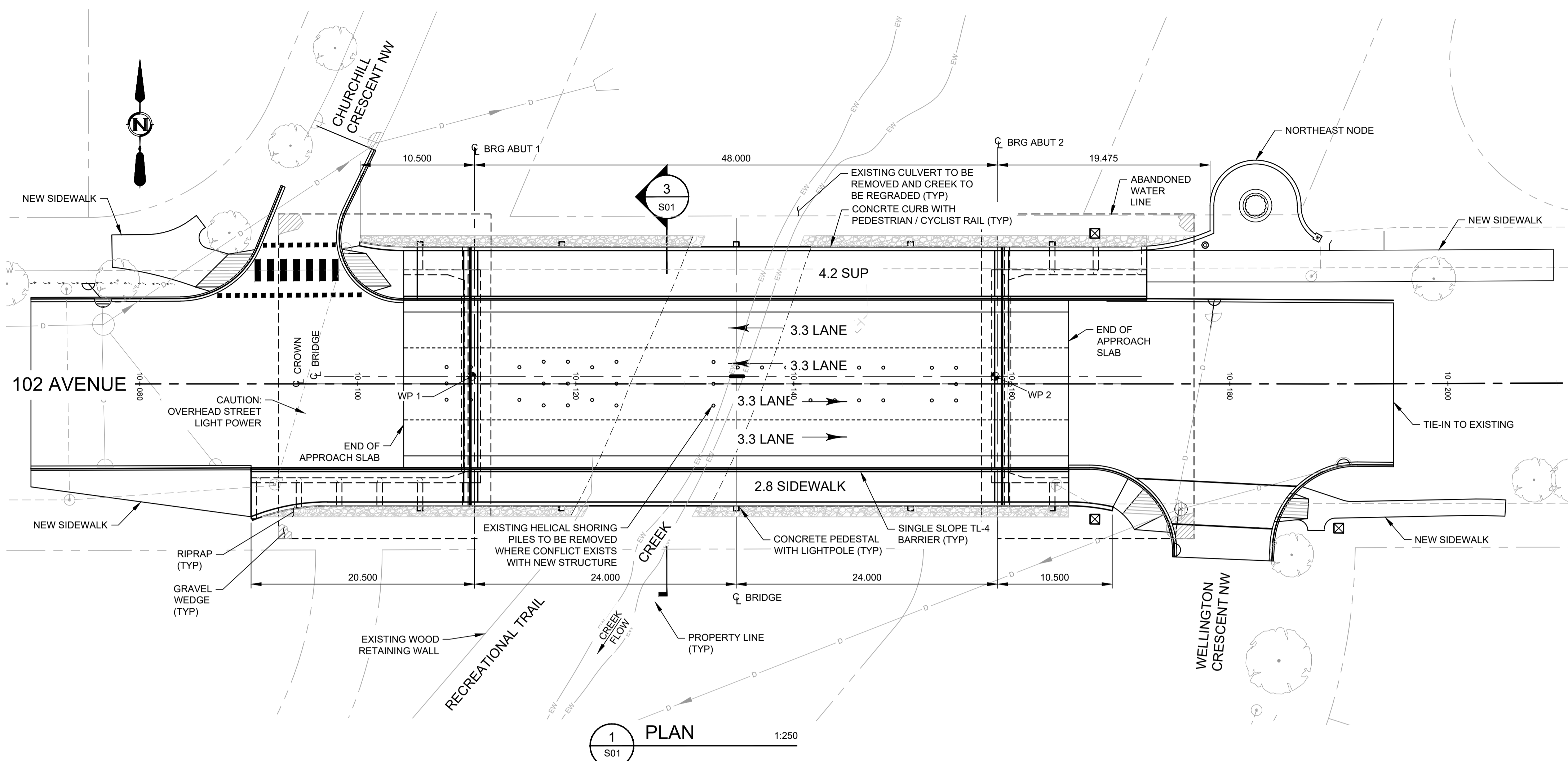


Approved By:

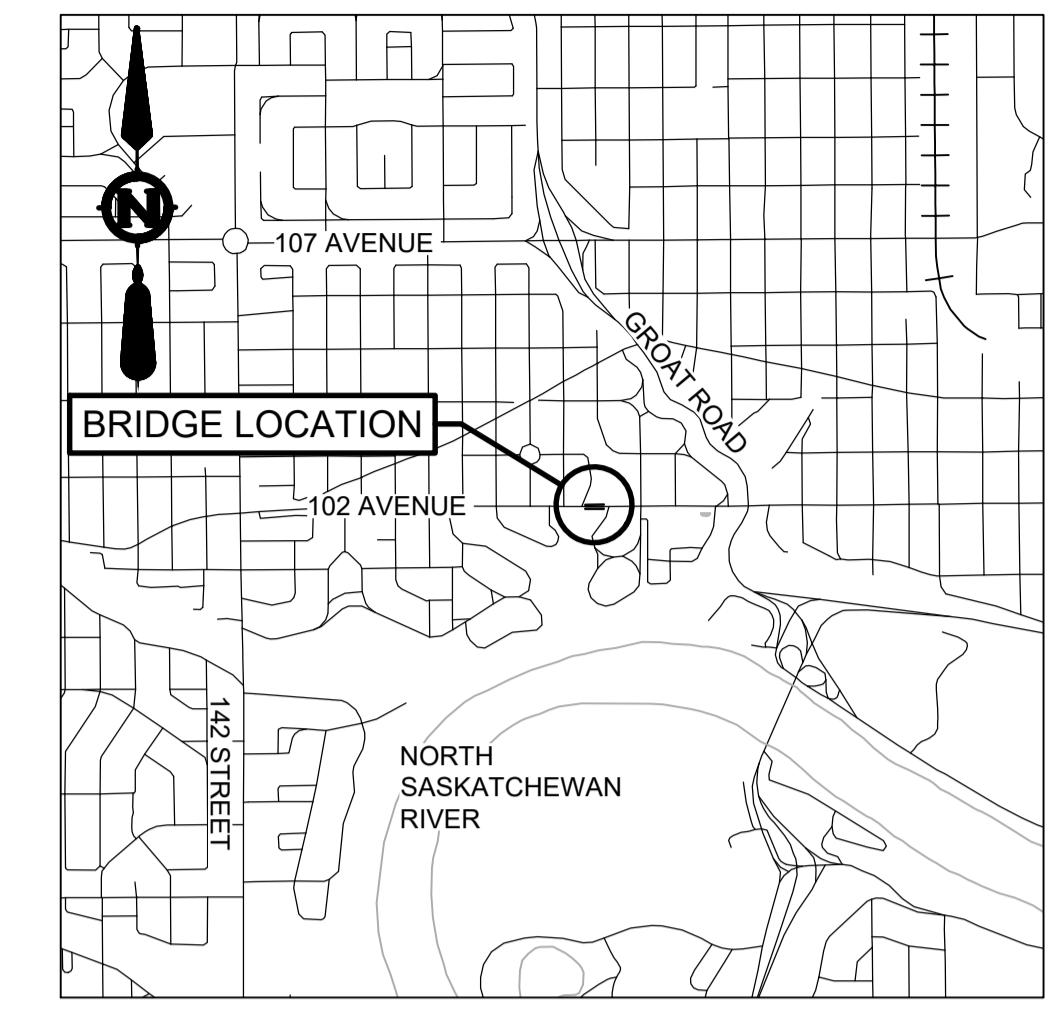
Ann-Marie Kalman, B.Sc.
 Lab Manager

Achyut Adhikari

APPENDIX D – UPDATED PRELIMINARY DESIGN DRAWINGS



1 PLAN 1:250

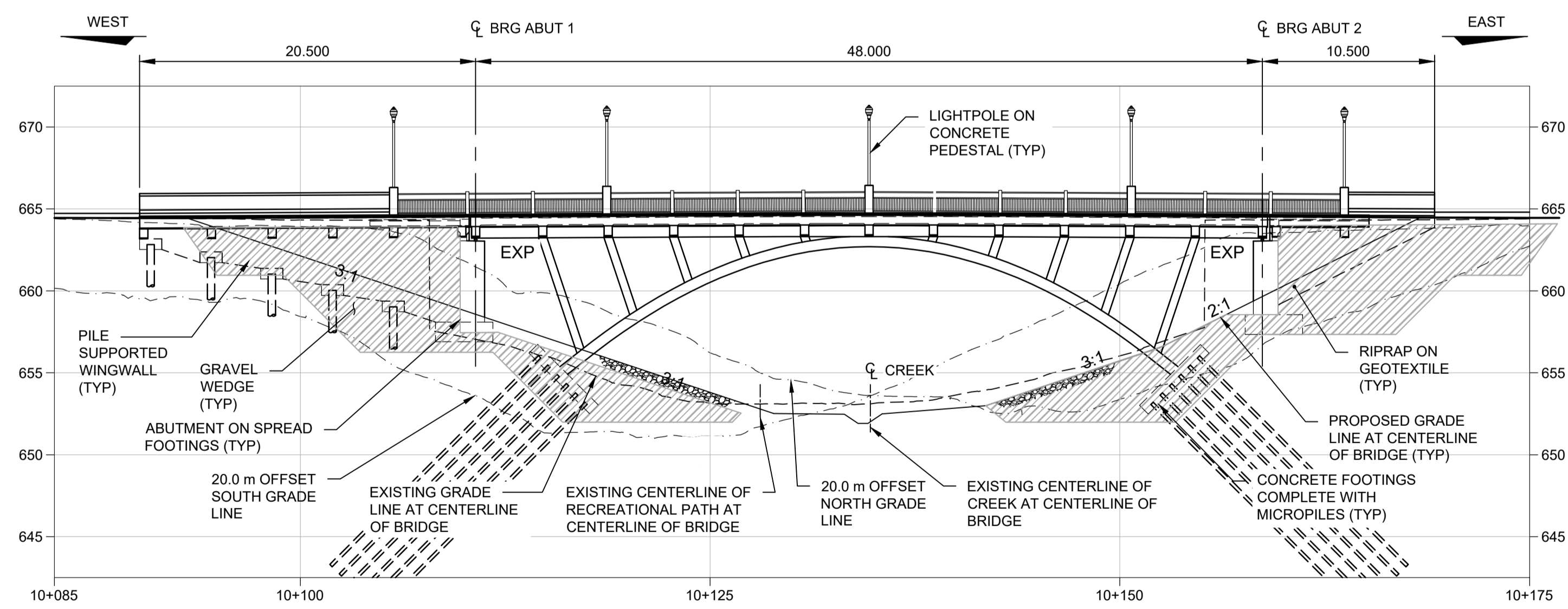


4 PLAN 1:25000
S01 SITE MAP

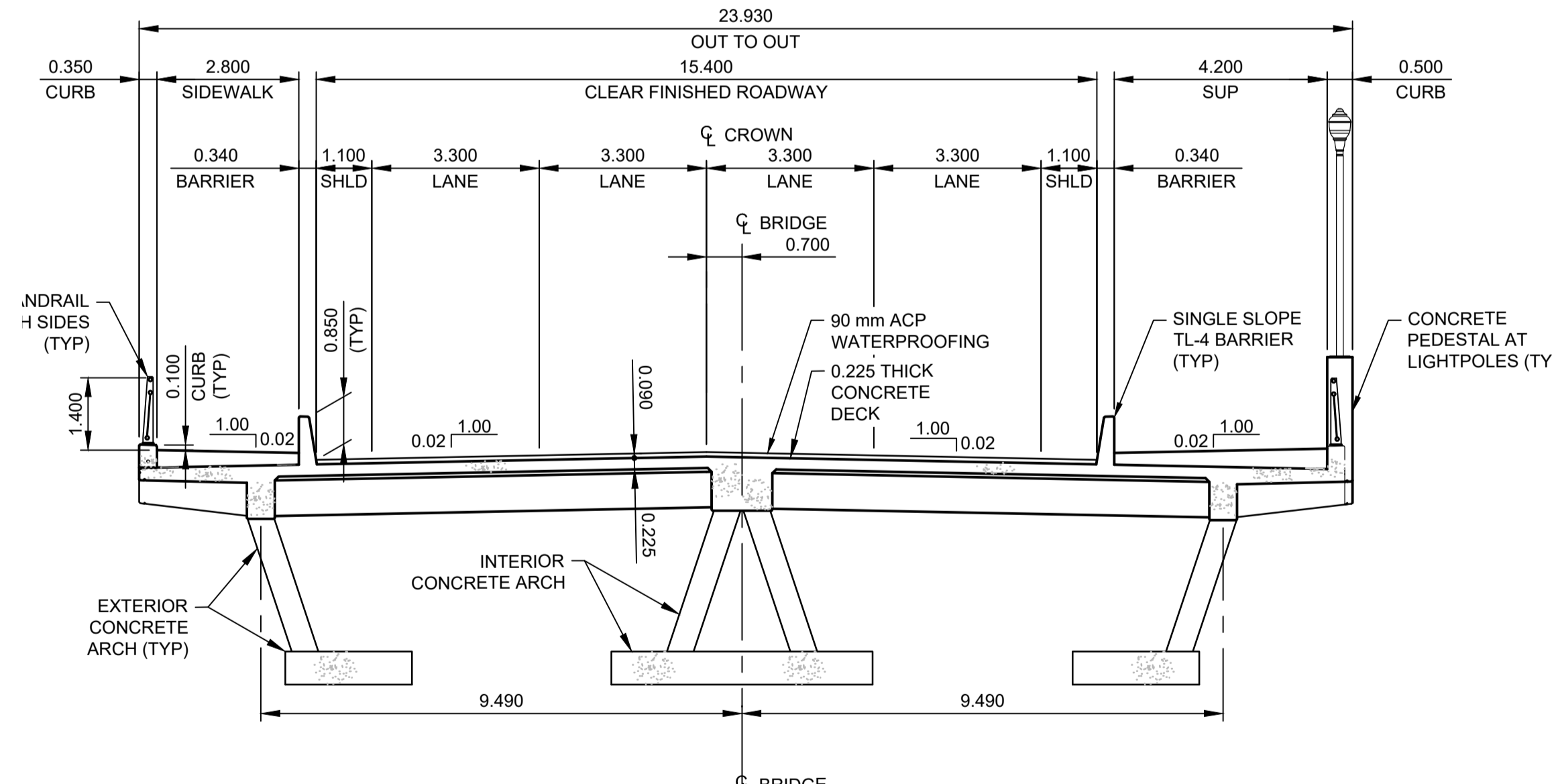
NOTES

- ALL DIMENSIONS ARE GIVEN IN MILLIMETERS UNLESS NOTED OTHERWISE

SURFACE UTILITY LEGEND			
○	TROLLEY POLES	⊕	TELEPHONE MANHOLE
○	WOODEN POWER POLE	⊕	TELEPHONE POLE
○	POWER POLE	⊕	DRAINAGE MANHOLE (SANITARY)
⊕	POWER POLE (SURVEYED)	⊕	DRAINAGE MANHOLE (STORM)
⊕	STREET LIGHT POLE	⊕	CATCH BASIN MANHOLE
⊕	STREET LIGHT POLE (SURVEYED)	⊕	CATCH BASIN
⊕	POWER MANHOLE	⊕	FIRE HYDRANT
⊕	POLE ANCHOR	⊕	FIRE HYDRANT (SURVEYED)
⊕	TRAFFIC POLE	⊕	WATER VALVE
⊕	TRAFFIC POLE (SURVEYED)	⊕	WATER TEE
⊕	TRAFFIC CABINET	⊕	ANODE
⊕	NEW LIGHTPOLE	⊕	ROADWAY SIGN



2 ELEVATION 1:250

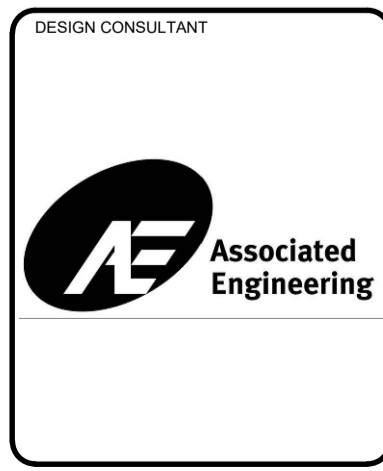


3 SECTION 1:250

NO.	REVISIONS	BY	DATE	APPD
1	ISSUED FOR DRAFT PRELIMINARY	JG	16APR2024	TA

PROGRAM NO.	
CONTRACT NO.	
AS BUILT / TO S885	
TENDER AWARD DATE	
ISSUE	BY DATE

CONTRACTOR	
SURVEYOR	
DATE	
FILE NUMBER	
CONSTRUCTION ENGINEER	DATE
GENERAL SUPERVISOR	DATE



**PRELIMINARY/
FOR DISCUSSION
NOT FOR CONSTRUCTION**

APPROVED FOR CONSTRUCTION

DEPARTMENT / BRANCH	APPROVAL	DATE
---------------------	----------	------

TRANSPORTATION INFRASTRUCTURE DELIVERY	DATE
MM/DD/YY	

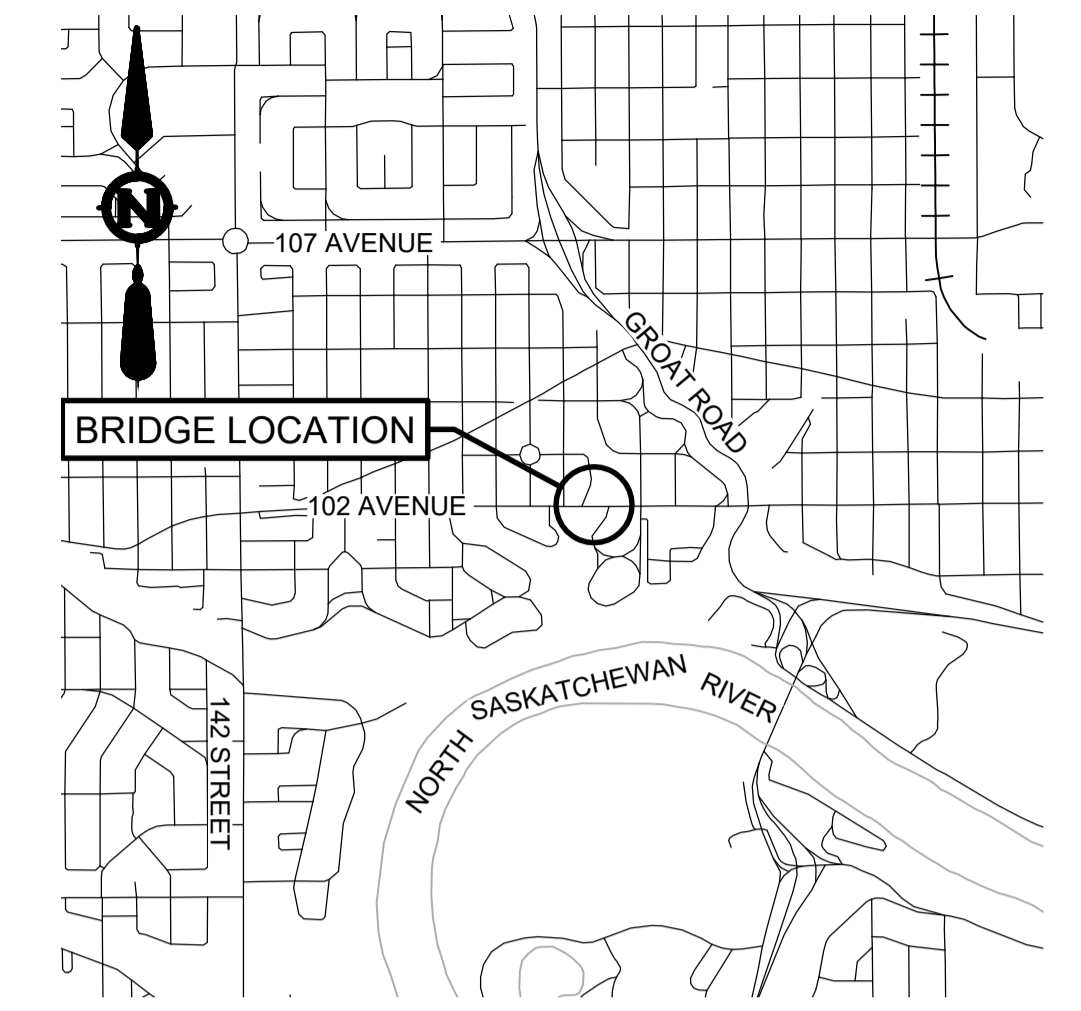
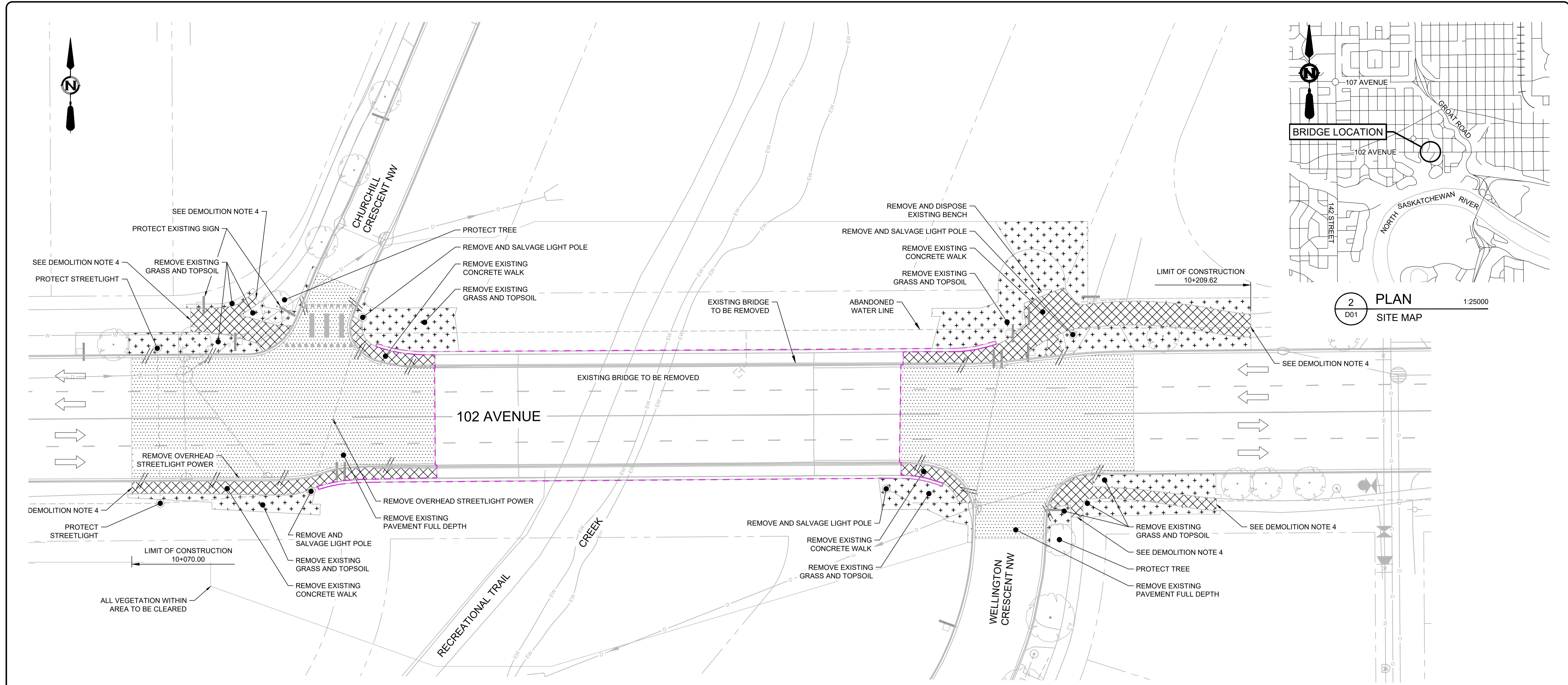
SURVEY	
JOB NO.	
SCALE	

DRAWN	T. KIRK	DATE	APR 2024
DESIGNED	J. GAGNE	DATE	APR 2024
CHECKED	T. ALEXANDER	DATE	APR 2024

Edmonton INTEGRATED INFRASTRUCTURE SERVICES
INFRASTRUCTURE DELIVERY BRANCH

PROJECT
**102 AVENUE OVER RAMSAY RAVINE
B499 - WELLINGTON BRIDGE REPLACEMENT**
MODERN ARCH - GENERAL LAYOUT

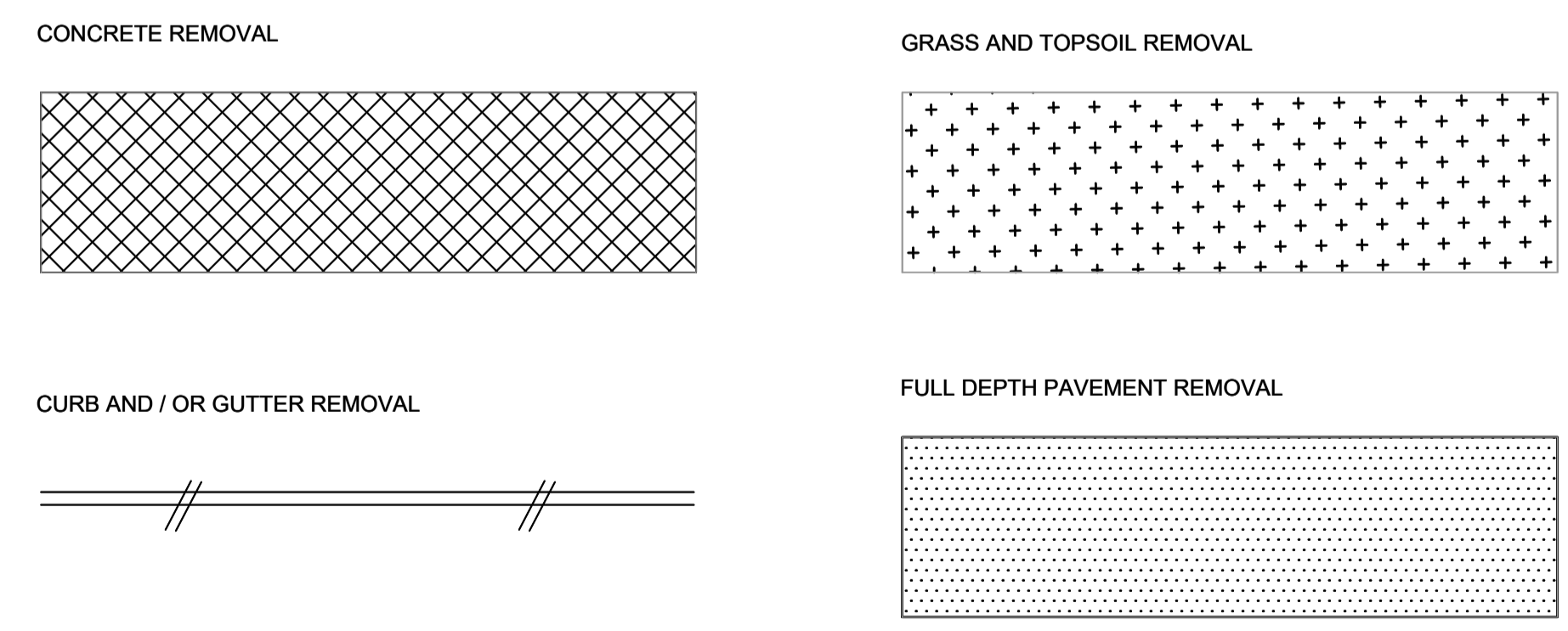
DRAWING
A102 P241 S01



2 PLAN
D01 SITE MAP 1:25000

1 PLAN
D01 102 AVENUE 1:250

LEGEND



GENERAL NOTES:

1. FINAL LIMITS OF GRASS REMOVAL, BASE REMOVAL, CURB REPLACEMENT AND MILLING AT MATCH LOCATIONS TO BE CONFIRMED WITH THE ENGINEER IN THE FIELD.
2. ALL EXISTING SIGNS AFFECTED BY THE WORK TO BE REMOVED AND SALVAGED.
3. ASPHALT AND CONCRETE REMOVALS TO BE DISPOSED OF AT AN APPROVED FACILITY. CONTRACTOR IS RESPONSIBLE FOR ANY DISPOSAL FEES.
4. EXISTING SURFACE AND UNDERGROUND STRUCTURES SHOWN ON THE DRAWINGS ARE NOT GUARANTEED TO BE ACCURATE. CONTRACTOR TO CONFIRM LOCATIONS OF ALL UTILITIES THAT MAY BE IN CONFLICT WITH PROPOSED WORKS.
5. ALL TREE PROTECTION, TREE RELOCATION AND SHRUB BED PROTECTION AND REMOVALS TO BE COORDINATED BETWEEN THE CONTRACTOR AND CONSULTANT/OWNER PRIOR TO COMMENCEMENT OF WORK.
6. ASPHALT AND CONCRETE REMOVALS TO BE DISPOSED OF AT AN APPROVED FACILITY. CONTRACTOR IS RESPONSIBLE FOR ANY DISPOSAL FEES.
7. ALL MATERIAL AND WORKMANSHIP SHALL MEET CITY OF EDMONTON STANDARDS.
8. ADJUST ALL AFFECTED MANHOLE AND CATCH BASIN FRAMES AND COVERS TO MATCH ELEVATION OF NEW ASPHALT.
9. THE CONTRACTOR MUST CONFORM TO THE REQUIREMENTS OF THE CITY OF EDMONTON EROSION AND SEDIMENTATION CONTROL GUIDELINES AND FIELD MANUAL.
10. ALL DIMENSIONS IN METRES UNLESS OTHERWISE NOTED.
11. PROTECT ALL APPURTENANCES TO REMAIN IN PLACE OR TO BE SALVAGED. REPLACE ITEMS DAMAGED DURING CONSTRUCTION ACTIVITY.
12. ALL SIGNS WITHIN THE CONSTRUCTION LIMITS TO BE REMOVED, SALVAGED, AND REINSTATED UNLESS OTHERWISE NOTED.

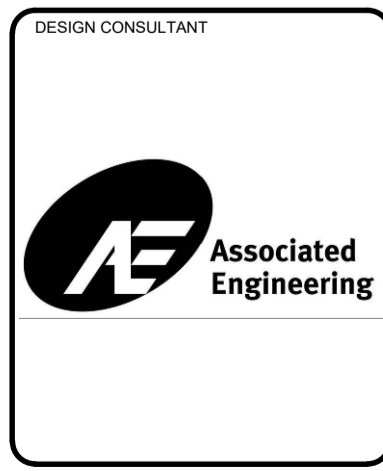
DEMOLITION NOTES:

1. REMOVE EXISTING CURB, GUTTER AND WALK AS REQUIRED.
2. FINAL LIMITS OF BASE REMOVAL, CURB REPLACEMENT AND MILLING AT MATCH LOCATIONS TO BE FIELD DETERMINED.
3. SAW-CUT ASPHALT AT LIMITS OF FULL DEPTH REMOVALS.
4. LIMIT OF CONCRETE SIDEWALK REMOVALS TO BE CONFIRMED ON SITE. REMOVE UP TO AN EXISTING CONCRETE JOINT.

7					
6					
5					
4					
3					
2					
1	ISSUED FOR DRAFT PRELIMINARY	WM	16APR2024	TA	
NO.	REVISIONS	BY	DATE	APPD	

PROGRAM NO.			
CONTRACT NO.			
AS BUILT / TO SRS			
TENDER AWARD DATE			
NO.	ISSUE	BY	DATE

CONSTRUCTION RETURN	
CONTRACTOR	
SURVEYOR	
DATE	
FILE NUMBER	
CONSTRUCTION ENGINEER	DATE
GENERAL SUPERVISOR	DATE



**PRELIMINARY/
FOR DISCUSSION
NOT FOR CONSTRUCTION**

APPROVED FOR CONSTRUCTION

DATE

DEPARTMENT / BRANCH	
APPROVAL	
DATE	

TRANSPORTATION INFRASTRUCTURE DELIVERY	DATE
	MM/DD/YY
SURVEY	
JOB NO.	
SCALE	
SCALES SHOWN ARE CORRECT FOR FULL SIZE PLOTS (A1 SHEET SIZE)	
DESIGNED	DATE
DESIGNED BY	DATE
CHECKED	DATE
CHECKED BY	DATE

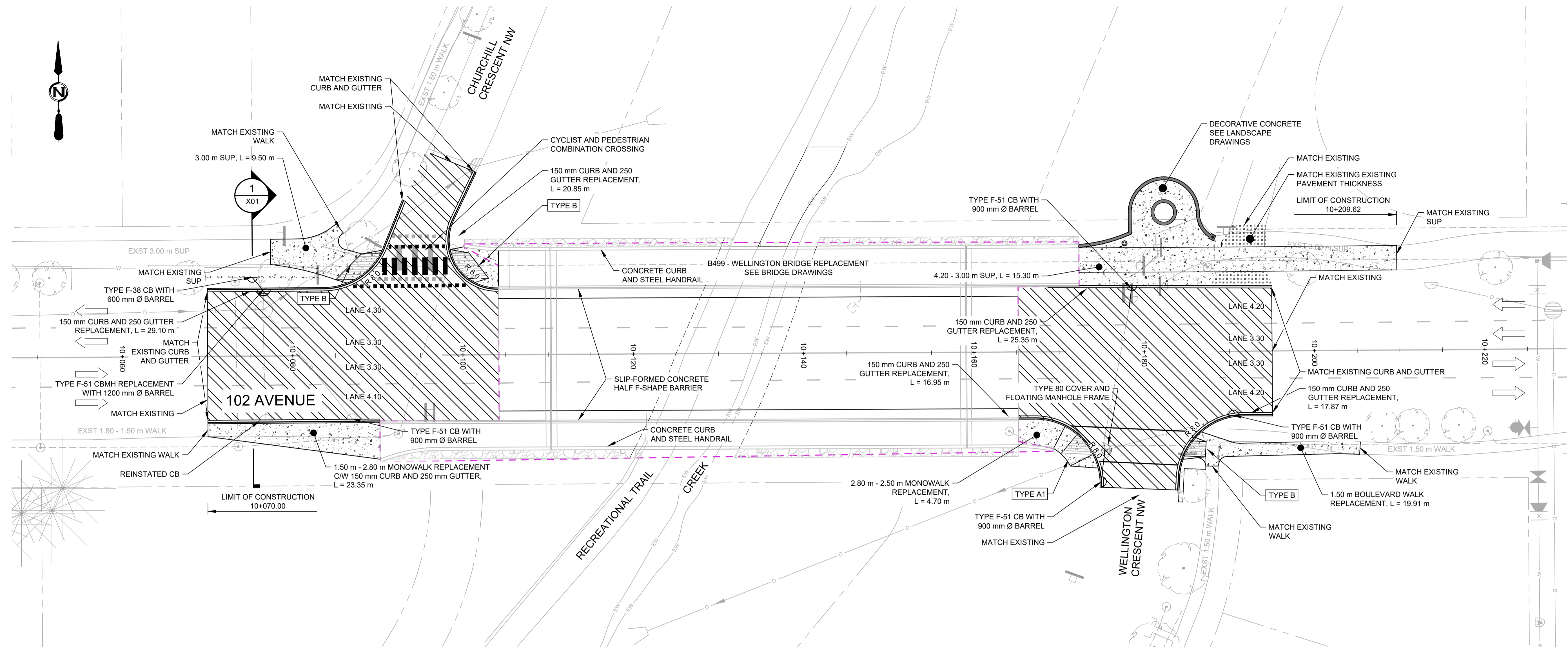
DESIGNED	DATE
DESIGNED BY	DATE
CHECKED	DATE
CHECKED BY	DATE



INTEGRATED INFRASTRUCTURE SERVICES
INFRASTRUCTURE DELIVERY BRANCH

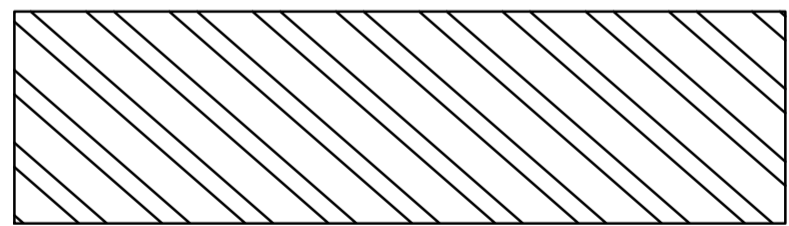
**102 AVENUE OVER RAMSAY RAVINE
B499 - WELLINGTON BRIDGE REPLACEMENT
REMOVALS PLAN**

A102 P241 D01

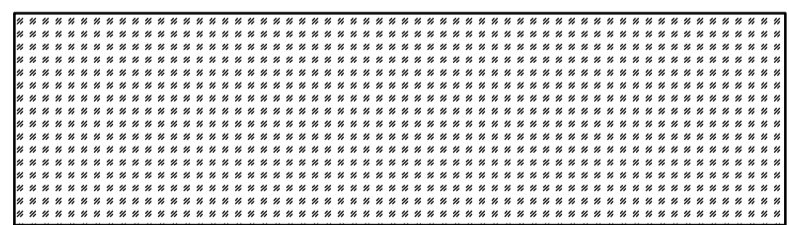


LEGEND

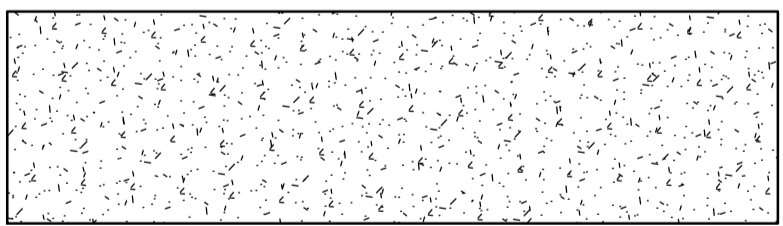
FULL REBUILD
 60 mm 10 mm-HT ASPHALT
 110 mm 20 mm-B ASPHALT
 350 mm GRAVEL BASE
 150 mm CEMENT STABILIZED SUBGRADE



ALLEY ASPHALT PAVEMENT



CONCRETE



150 mm CURB AND 250 mm GUTTER AS PER COMPLETE STREETS DESIGN AND CONSTRUCTION STANDARDS, DRAWING 5000 FOR CURB AND GUTTER AND DRAWING 5100 FOR MONOLITHIC WALK, CURB AND GUTTER

1 PLAN
 D02 102 AVENUE 1:250

SURFACE UTILITY LEGEND

○ TROLLEY POLES	□ TELEPHONE MANHOLE
○ WOODEN POWER POLE	○ TELEPHONE POLE
○ POWER POLE	○ DRAINAGE MANHOLE (SANITARY)
○ POWER POLE (SURVEYED)	○ DRAINAGE MANHOLE (STORM)
□ STREET LIGHT POLE	○ CATCH BASIN MANHOLE
○ STREET LIGHT POLE (SURVEYED)	○ CATCH BASIN
□ POWER MANHOLE	○ FIRE HYDRANT
→ POLE ANCHOR	○ FIRE HYDRANT (SURVEYED)
○ TRAFFIC POLE	○ WATER VALVE
○ TRAFFIC POLE (SURVEYED)	○ WATER TEE
□ TRAFFIC CABINET	○ ANODE
○ NEW LIGHTPOLE	□ ROADWAY SIGN

GENERAL NOTES:

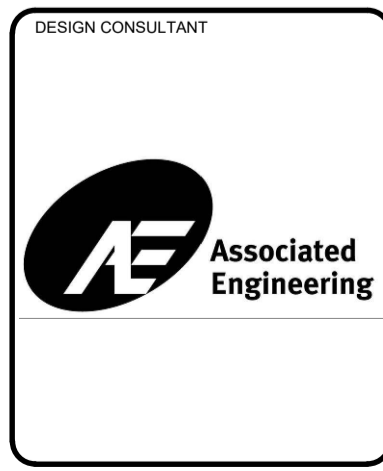
- ADJUST MANHOLES AND VALVES AS REQUIRED TO MATCH NEW PAVEMENT.
- ALL AREAS OF DISTURBANCE ADJACENT TO NEW CONSTRUCTION SHALL BE LANDSCAPED AS REQUIRED.
- LANDSCAPING OF ALL BOULEVARD AREAS TO MEET COMMUNITY SERVICES SPECIFICATIONS: ALL SOD OVER 100 mm TOPSOIL. ALL SEED OVER 150 mm TOPSOIL.
- ALL CURB AND GUTTER CONSTRUCTION TO BE 150 mm STANDARD CURB AND 250 mm GUTTER AS PER DRAWING 5000 OF COMPLETE STREETS DESIGN AND CONSTRUCTION STANDARDS, UNLESS OTHERWISE NOTED.
- A1 - CURB RAMP AS PER TYPE A1 ON DRAWING 5510 OF COMPLETE STREETS DESIGN AND CONSTRUCTION STANDARDS.
- A2 - CURB RAMP AS PER TYPE A2 ON DRAWING 5510 OF COMPLETE STREETS DESIGN AND CONSTRUCTION STANDARDS.
- B - CURB RAMP AS PER TYPE B ON DRAWING 5510 OF COMPLETE STREETS DESIGN AND CONSTRUCTION STANDARDS.
- C - CURB RAMP AS PER TYPE C ON DRAWING 5510 OF COMPLETE STREETS DESIGN AND CONSTRUCTION STANDARDS.
- THE PEDESTRIAN CROSSING TO BE CONSTRUCTED AS PER DRAWING 5215 OF COMPLETE STREETS DESIGN AND CONSTRUCTION STANDARDS.
- CONCRETE WALKS AND SHARED USE PATH AS PER DRAWING 5140 (WITH VARYING WIDTH) OF COMPLETE STREETS DESIGN AND CONSTRUCTION STANDARDS.
- ALL NEW MONOLITHIC SIDEWALKS TO BE 150 mm BARRIER CURBS AND 250 mm GUTTER, UNLESS OTHERWISE NOTED.
- REMOVE EXISTING CURB, GUTTER AND WALK AS REQUIRED.
- ALL TIES ARE TO LIP OF GUTTER (FOR CURB AND GUTTER CONSTRUCTION), TO CURB FACE (FOR SLAB-ON CONSTRUCTION).
- FINAL LIMITS OF BASE REMOVAL, CURB REPLACEMENT AND GRINDING AT MATCH LOCATIONS TO BE FIELD DETERMINED.

- NEW OVERLAY TO MATCH LIP OF GUTTER AT ALL NEW CURB RAMP LOCATIONS.
- SAW-CUT AREAS OF BASE REMOVAL.
- CATCH BASIN NOTES:
 - RELOCATE/ADJUST CATCH BASINS TO MATCH NEW ALIGNMENT/GRADES (AS REQUIRED).
 - IF NEW ASPHALT OVERLAY IS 50 mm OR LESS, WRAP ASPHALT TO MATCH EXISTING LIP OF GUTTER AT ALL CATCH BASINS.
 - IF NEW ASPHALT OVERLAY IS GREATER THAN 50 mm, RECONSTRUCT CURB, GUTTER AND CATCH BASINS TO MATCH OVERLAY REQUIREMENT.
 - REPLACE CATCH BASIN FRAMES AND COVERS AS REQUIRED (TO BE DETERMINED IN FIELD).

7				
6				
5				
4				
3				
2				
1	ISSUED FOR DRAFT PRELIMINARY	WM	16APR2024	TA
NO.	REVISIONS	BY	DATE	APPD

PROGRAM NO.	
CONTRACT NO.	
AS BUILT / TO SRS	
TENDER AWARD DATE	
ISSUE	BY DATE

CONTRACTOR	
SURVEYOR	
DATE	
FILE NUMBER	
CONSTRUCTION ENGINEER	DATE
GENERAL SUPERVISOR	DATE



**PRELIMINARY/
 FOR DISCUSSION
 NOT FOR CONSTRUCTION**

APPROVED FOR CONSTRUCTION

DATE

DEPARTMENT / BRANCH	
APPROVAL	DATE

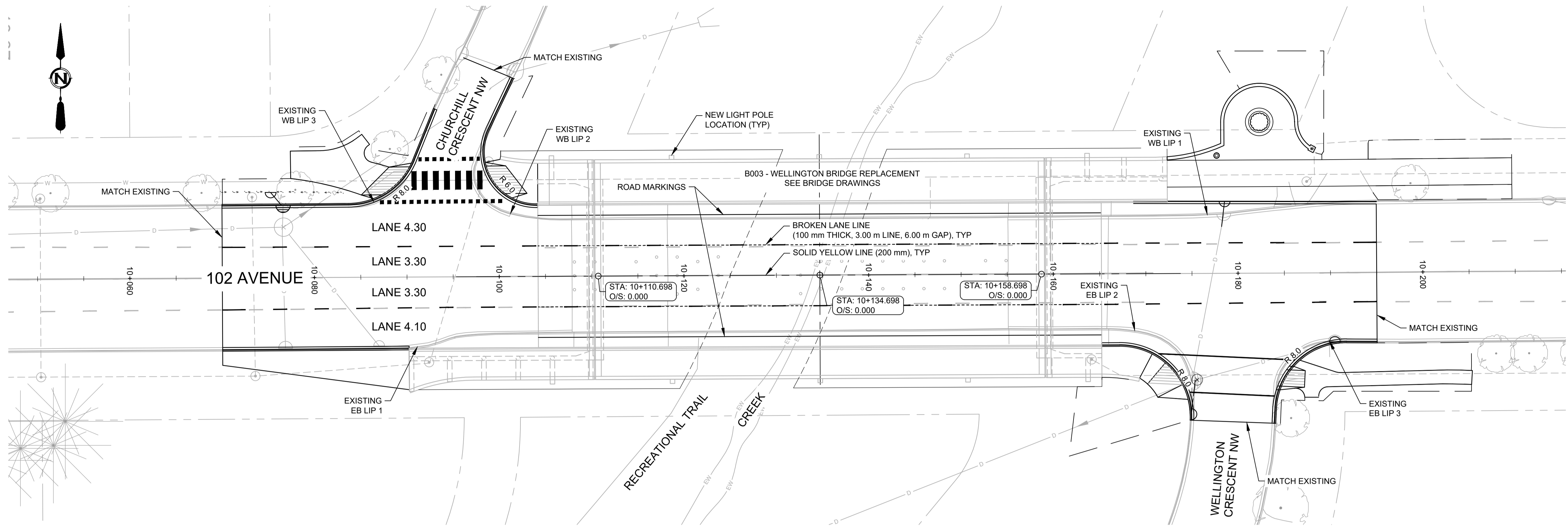
TRANSPORTATION INFRASTRUCTURE DELIVERY	DATE
	MM/DD/YY
SURVEY	
JOB NO.	
SCALE	
SCALES SHOWN ARE CORRECT FOR FULL SIZE PLOTS (A1 SHEET SIZE)	
DESIGNED	DATE
J. MAREE	APR 2024
CHECKED	DATE
W. MCKAY	APR 2024

DRAWN	DATE
T. KIRK	APR 2024
DESIGNED	DATE
J. MAREE	APR 2024
CHECKED	DATE
W. MCKAY	APR 2024

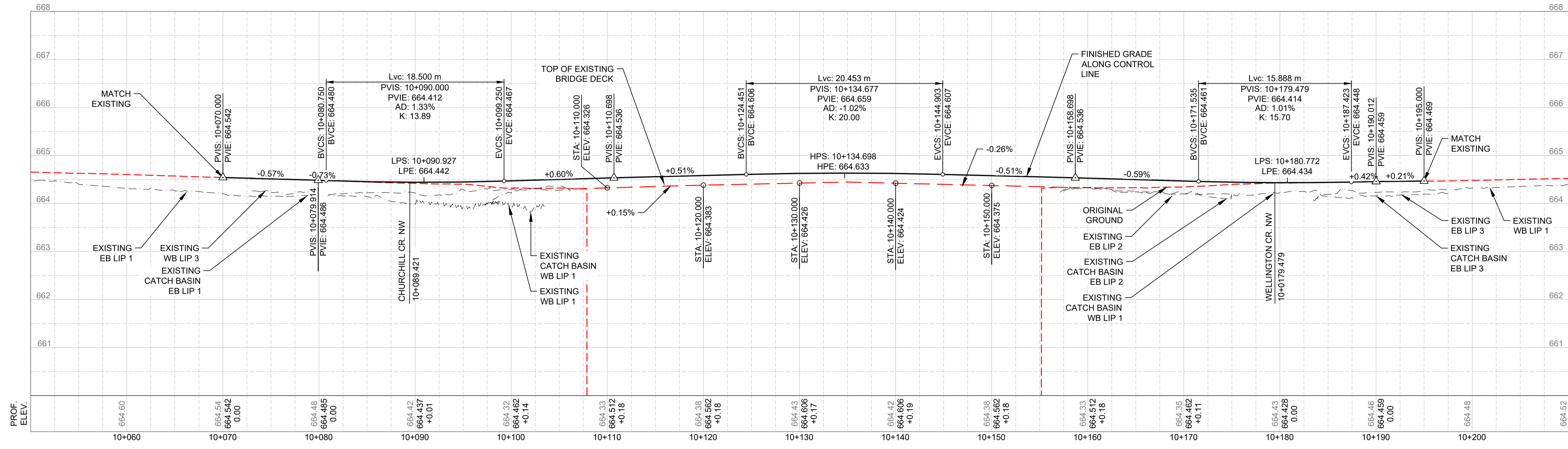
Edmonton INTEGRATED INFRASTRUCTURE SERVICES
 INFRASTRUCTURE DELIVERY BRANCH

PROJECT
**102 AVENUE OVER RAMSAY RAVINE
 B499 - WELLINGTON BRIDGE REPLACEMENT**
 NEW CONSTRUCTION PLAN

DRAWING
A102 P241 D02



1 PLAN
G01 102 AVENUE 1:250

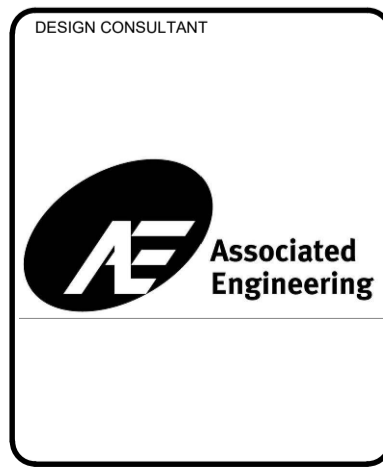


2 PROFILE
G01 102 AVENUE OVER WELLINGTON BRIDGE HZ 1:250, VT 1:25

7				
6				
5				
4				
3				
2				
1	ISSUED FOR DRAFT PRELIMINARY	WM	16APR2024	TA
NO.	REVISIONS	BY	DATE	APPD

PROGRAM NO.			
CONTRACT NO.			
4			
3			
2	AS BUILT / TO GRS		
1	TENDER AWARD DATE		
NO.	ISSUE	BY	DATE

CONSTRUCTION RETURN	
CONTRACTOR	
SURVEYOR	
DATE	
FILE NUMBER	
CONSTRUCTION ENGINEER DATE	
GENERAL SUPERVISOR DATE	



**PRELIMINARY/
FOR DISCUSSION
NOT FOR CONSTRUCTION**

APPROVED FOR CONSTRUCTION

DATE

TRANSPORTATION PLANNING AND DESIGN SUPERVISOR		
DEPARTMENT / BRANCH	APPROVAL	DATE

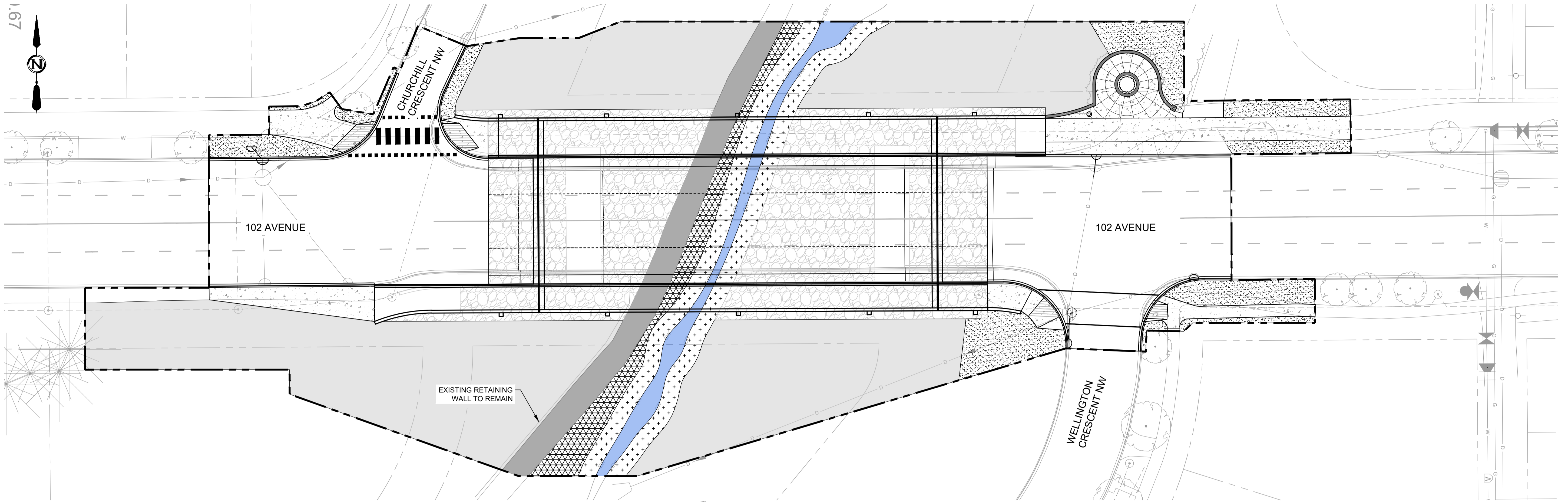
TRANSPORTATION INFRASTRUCTURE DELIVERY		
DATE MM/DD/YY		
SURVEY		
JOB NO.		
SCALE		
SCALES SHOWN ARE CORRECT FOR FULL SIZE PLOTS (A1 SHEET SIZE)		
DATE	DATE	DATE
DATE	DATE	DATE
DATE	DATE	DATE

DATE	DATE	DATE
DATE	DATE	DATE
DATE	DATE	DATE
DATE	DATE	DATE
DATE	DATE	DATE
DATE	DATE	DATE

Edmonton INTEGRATED INFRASTRUCTURE SERVICES
INFRASTRUCTURE DELIVERY BRANCH

**102 AVENUE OVER RAMSAY RAVINE
B499 - WELLINGTON BRIDGE REPLACEMENT**
PLAN AND PROFILE

A102 P241 G01



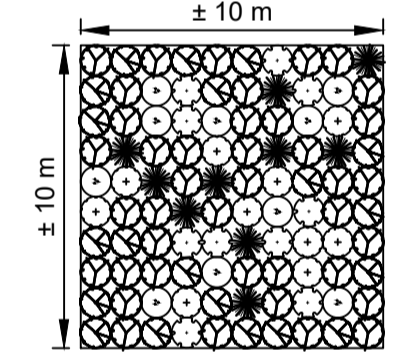
1 PLAN
L-100 RESTORATION LAYOUT 1:250

- LEGEND**
- RESTORATION BOUNDARY
 - RESTORED ASPHALT PATH
- SEE CIVIL DRAWINGS
 - EXISTING CREEK
 - CONCRETE WALKWAY
- SEE CIVIL DRAWINGS
 - RIP-RAP
- SEE STRUCTURAL DRAWINGS
 - ROUGH AND LOOSE SOIL TREATMENT WITH TREE AND SHRUB PLANTING
- TOTAL AREA: 1791 m²
 - PARKS MAINTENANCE #1 MIX
- SEE LANDSCAPE RESTORATION DRAWING
 - LIVE WILLOW STAKING
- TOTAL AREA: 256 m²
 - SHRUB PLANTING
- TOTAL AREA: 128 m²

TREE AND SHRUB PLANTING 10 x 10 ENLARGEMENT SAMPLE

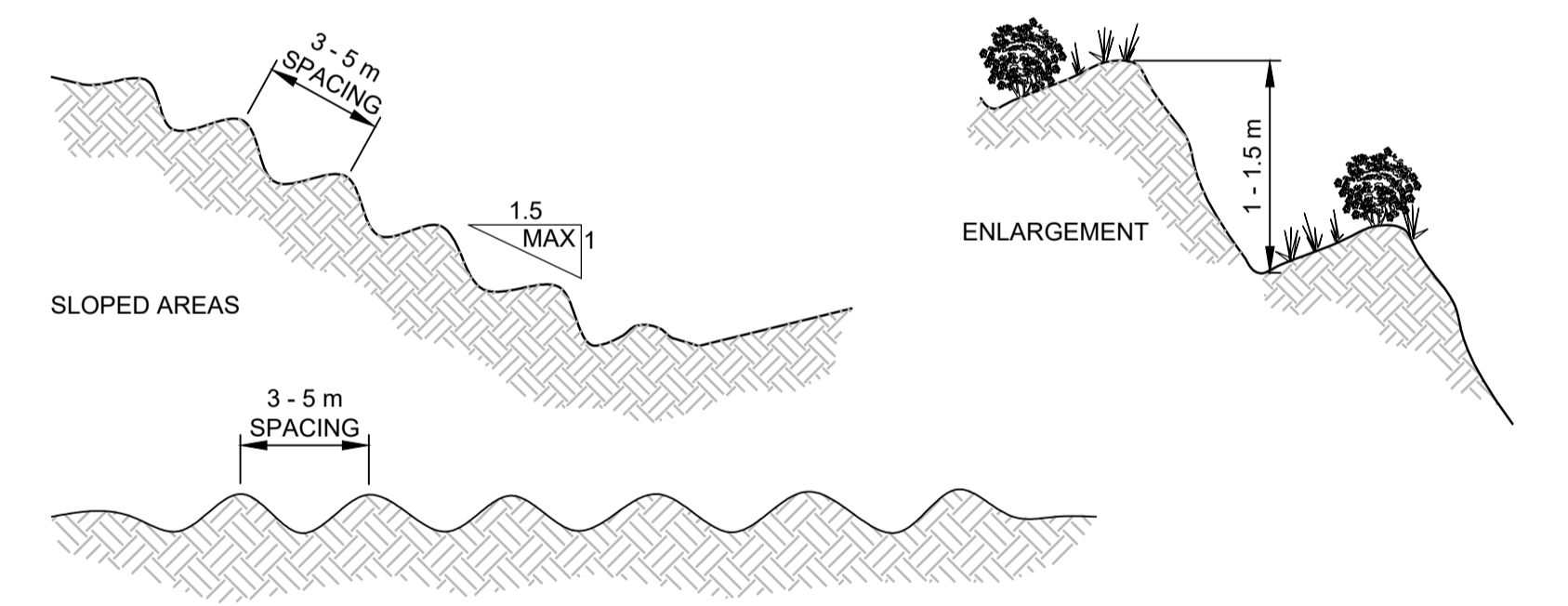
QTY	SYM	BOTANICAL NAME	COMMON NAME	SPACING
CONIFEROUS TREES				
10		<i>Picea glauca</i>	White Spruce	1.0 m
DECIDUOUS TREES				
40		<i>Populus balsamifera</i>	Balsam Poplar	1.0 m
20		<i>Populus tremuloides</i>	Trembling Aspen	1.0 m
DECIDUOUS SHRUBS				
10		<i>Cornus sericea</i>	Red Osier Dogwood	1.0 m
10		<i>Rosa woodsii</i>	Wild Rose	1.0 m
10		<i>Symphoricarpus albus</i>	Snowberry	1.0 m

* TREE AND SHRUB SYMBOLS ILLUSTRATED AT 1.0 m SIZE AND SPACING NOTED ABOVE



RESTORATION PLANTING QUANTITIES

QTY	SYM	BOTANICAL NAME	COMMON NAME	SIZE	NOTES
CONIFEROUS TREES					
179		<i>Picea glauca</i>	White Spruce	1 GAL. POT.	UNIFORM BRANCHING, SINGLE STRAIGHT LEADER
DECIDUOUS TREES					
716		<i>Populus balsamifera</i>	Balsam Poplar	1 GAL. POT.	UNIFORM BRANCHING, SINGLE STRAIGHT LEADER
358		<i>Populus tremuloides</i>	Trembling Aspen	1 GAL. POT.	UNIFORM BRANCHING, SINGLE STRAIGHT LEADER
DECIDUOUS SHRUBS					
179		<i>Cornus sericea</i>	Red Osier Dogwood	1 GAL. POT.	SHRUBS TO BE FULL AND HAVE NATURAL FORM
179		<i>Rosa acicularis</i>	Prickly Wild Rose	1 GAL. POT.	SHRUBS TO BE FULL AND HAVE NATURAL FORM
179		<i>Symphoricarpus albus</i>	Snowberry	1 GAL. POT.	SHRUBS TO BE FULL AND HAVE NATURAL FORM
SHRUB PLANTING					
DECIDUOUS SHRUBS					
32		<i>Cornus sericea</i>	Red Osier Dogwood	1 GAL. POT.	SHRUBS TO BE FULL AND HAVE NATURAL FORM. 1.0 m SPACING
32		<i>Rosa acicularis</i>	Prickly Wild Rose	1 GAL. POT.	SHRUBS TO BE FULL AND HAVE NATURAL FORM. 1.0 m SPACING
32		<i>Symphoricarpus albus</i>	Snowberry	1 GAL. POT.	SHRUBS TO BE FULL AND HAVE NATURAL FORM. 1.0 m SPACING
32		<i>Viburnum trilobum</i>	Highbush Cranberry	1 GAL. POT.	SHRUBS TO BE FULL AND HAVE NATURAL FORM. 1.0 m SPACING



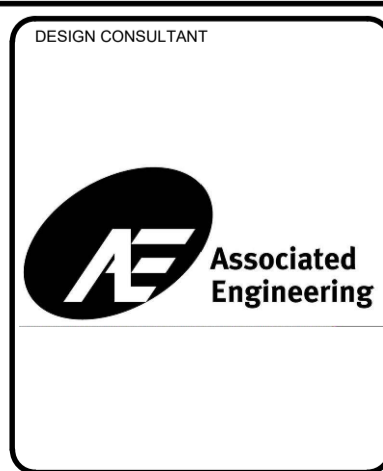
- FLAT AREAS**
- NOTES:**
- TOPSOIL AND COARSE WOODY DEBRIS TO BE SALVAGED PRIOR TO CONSTRUCTION AND STOCKPILED FOR USE DURING RESTORATION.
 - ROUGH AND LOOSE SOIL TREATMENT TO BE INSTALLED ON SLOPES 2:1 OR FLATTER. MODIFIED BRUSH LAYERS TO BE INSTALLED IN STEEPER AREAS WHERE SOIL ROUGHENING CANNOT BE COMPLETED DUE TO EQUIPMENT ACCESS.
 - ROUGHEN THE SURFACE TO CREATE HOLES AND MOUNDS.
 - CREATE HOLES USING AN EXCAVATOR WITH A DIGGING BUCKET.
 - PLACE SOIL HALF IN AND HALF OUT OF THE HOLE THAT WAS JUST SCOOPED OUT.
 - MOVE HALF BUCKET WIDTH TO THE RIGHT OF FIRST HOLE AND TAKE ANOTHER SCOOP OF SOIL AND TAKE CARE TO SHATTER THE COLUMN BETWEEN THE HOLES WITH THE SIDE OF THE BUCKET PLACING IT BETWEEN THE TWO HOLES.
 - MOVE A HALF BUCKET WIDTH TO THE RIGHT OF THE SECOND HOLE AND TAKE ANOTHER SCOOP OF SOIL PLACING BETWEEN THE SECOND AND THIRD HOLES.
 - REPEAT WITHIN REASONABLE SWING OF EXCAVATOR THEN BACK UP THE WIDTH OF THE ROW OF HOLES AND MOUNDS LINING UP THE HOLES IN THE NEW ROW WITH THE MOUNDS IN THE PREVIOUS ROW.
 - CONTINUE UNTIL WHOLE AREA IS COVERED WITH HOLES AND MOUNDS.
- 2 DETAIL
L-100 ROUGH AND LOOSE SOIL TREATMENT NTS

NO.	REVISIONS	BY	DATE	APPD
1	ISSUED FOR DRAFT PRELIMINARY	DC	2024APR16	KA

PROGRAM NO.	
CONTRACT NO.	
AS BUILT / TO GIS	
TENDER AWARD DATE	
ISSUE	BY
DATE	

CONSTRUCTION RETURN

CONTRACTOR	
SURVEYOR	
DATE	
FILE NUMBER	
CONSTRUCTION ENGINEER	DATE
GENERAL SUPERVISOR	DATE



PRELIMINARY/
FOR DISCUSSION
NOT FOR CONSTRUCTION

APPROVED FOR CONSTRUCTION

DEPARTMENT / BRANCH	
APPROVAL	DATE

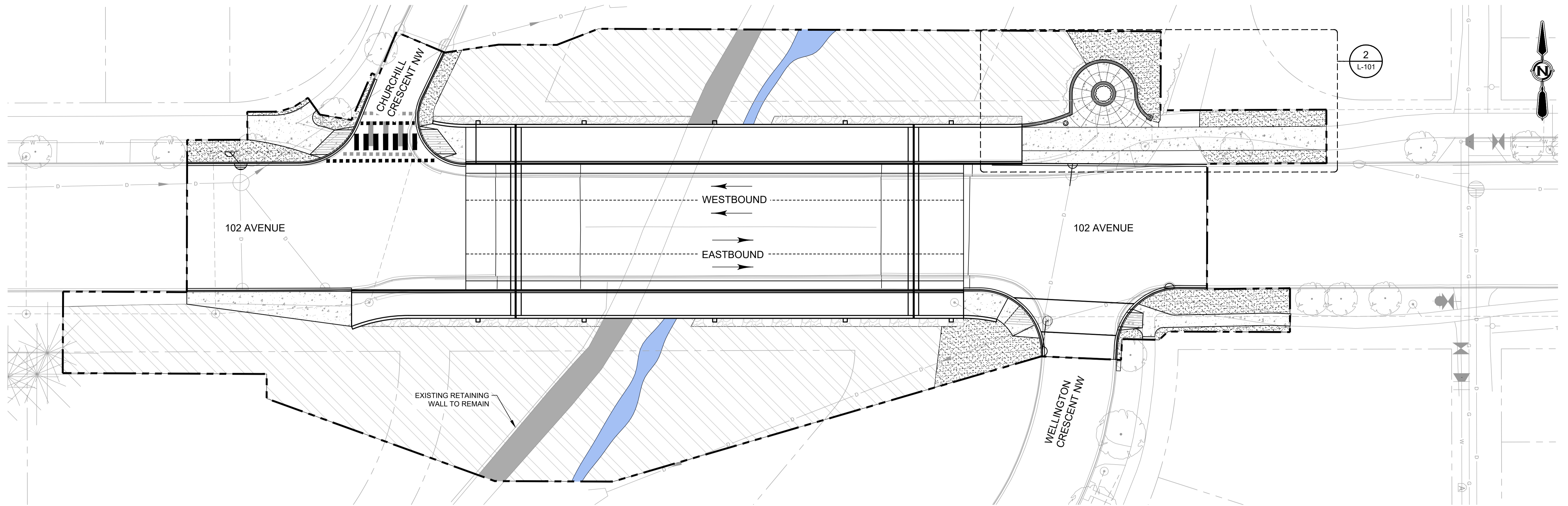
TRANSPORTATION PLANNING AND DESIGN SUPERVISOR	
APPROVAL	DATE

SURVEY	DATE
JOB NO.	
SCALE	
SCALES SHOWN ARE CORRECT FOR FULL SIZE PLOTS (A1 SHEET SIZE)	
CHECKED	DATE
C. ISHII	04/15/24

Edmonton INTEGRATED INFRASTRUCTURE SERVICES
INFRASTRUCTURE DELIVERY BRANCH

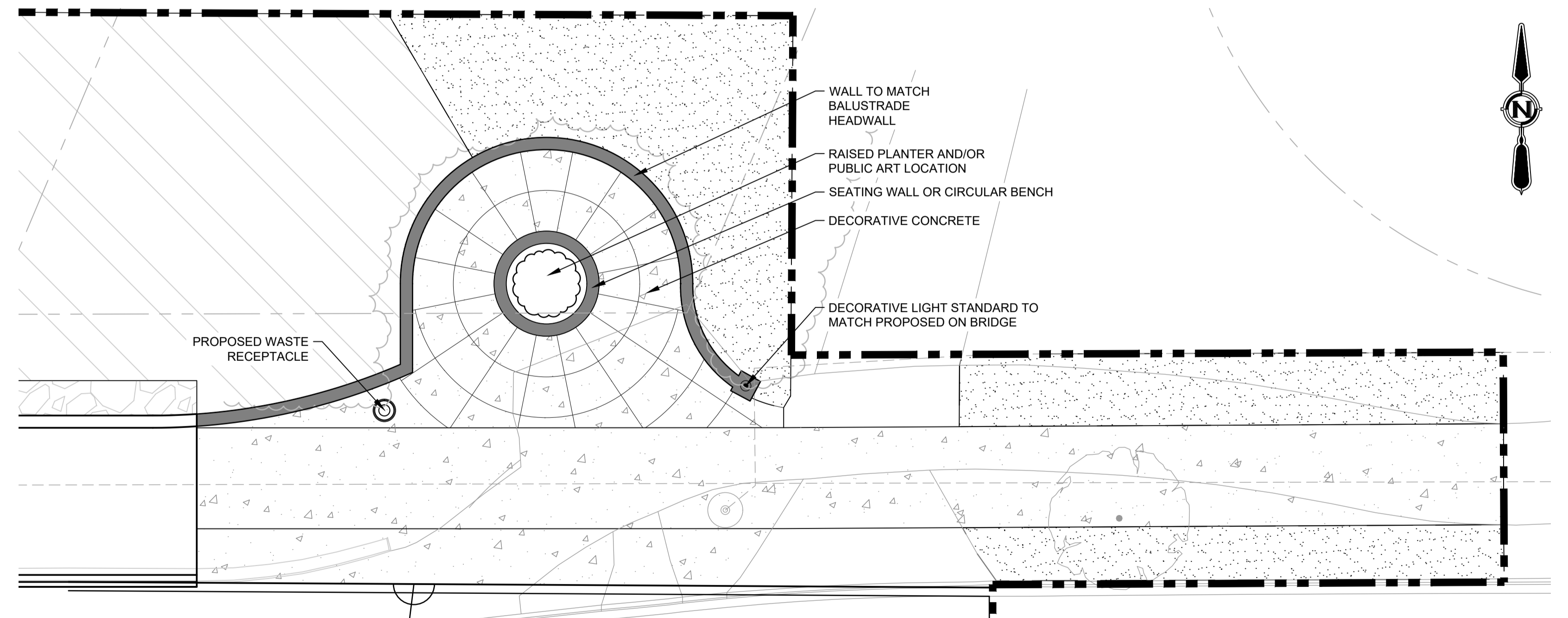
**102 AVENUE OVER RAMSAY RAVINE
B499 - WELLINGTON BRIDGE REPLACEMENT**
RAVINE AND CREEK RESTORATION

A102 P241 L01



PLAN 1:250
LANDSCAPE RESTORATION

- LEGEND**
- RESTORATION BOUNDARY
 - RESTORED ASPHALT PATH
- SEE CIVIL DRAWINGS
 - EXISTING CREEK
 - CONCRETE WALKWAY
- SEE CIVIL DRAWINGS
 - RIP-RAP
- SEE STRUCTURAL DRAWINGS
 - RESTORATION TREATMENTS
- SEE RAVINE AND CREEK RESTORATION DRAWING
 - PARKS MAINTENANCE #1 MIX
OVER 150 mm TOPSOIL
- TOTAL AREA: 318 m²
- PARKS MAINTENANCE #1 MIX**
- | | |
|-------------------------------|-----|
| TOUCHDOWN KENTUCKY BLUEGRASS | 30% |
| CREeping RED FESCUE | 30% |
| BANFF KENTUCKY BLUEGRASS | 20% |
| FIESTA II PERENNIAL RYE GRASS | 20% |



1 PLAN 1:100
L-101 NODE ENLARGEMENT

7					
6					
5					
4					
3					
2					
1	ISSUED FOR DRAFT PRELIMINARY	DC	2024APR16	JB	
NO.	REVISIONS	BY	DATE	APPD	

PROGRAM NO. _____	
CONTRACT NO. _____	
4	
3	
2	AS BUILT / TO GBS
1	TENDER AWARD DATE
NO.	ISSUE BY DATE

CONSTRUCTION RETURN	
CONTRACTOR _____	
SURVEYOR _____	
DATE _____	
FILE NUMBER _____	
CONSTRUCTION ENGINEER	DATE
GENERAL SUPERVISOR	DATE

DESIGN CONSULTANT

Associated Engineering

**PRELIMINARY/
FOR DISCUSSION**
NOT FOR CONSTRUCTION

APPROVED FOR CONSTRUCTION

DATE _____

TRANSPORTATION PLANNING AND DESIGN SUPERVISOR	APPROVAL	DATE
DEPARTMENT / BRANCH		

TRANSPORTATION INFRASTRUCTURE DELIVERY		DATE
		MM/DD/YY
SURVEY		
JOB NO.		
SCALE		
SCALES SHOWN ARE CORRECT FOR FULL SIZE PLOTS (A1 SHEET SIZE)		
DRAWN	D. CHARTRAND	04/16/24
DESIGNED	J. BENNETT	04/16/24
CHECKED	M. KEITH	04/16/24

Edmonton INTEGRATED INFRASTRUCTURE SERVICES
INFRASTRUCTURE DELIVERY BRANCH

PROJECT
**102 AVENUE OVER RAMSAY RAVINE
B499 - WELLINGTON BRIDGE REPLACEMENT**
LANDSCAPE RESTORATION

DRAWING
A102 P241 L02

Achyut Adhikari

APPENDIX E – WELLINGTON BRIDGE REPLACEMENT BAT MITIGATION PLAN



Associated
Engineering

GLOBAL PERSPECTIVE.
LOCAL FOCUS.

REPORT

City of Edmonton

Wellington Bridge Replacement Bat Mitigation Plan



APRIL 2024



Platinum
member

CONFIDENTIALITY AND © COPYRIGHT FOR THIS REPORT

This document is for the sole use of the addressee and Associated Engineering Alberta Ltd. The document contains proprietary and confidential information that shall not be reproduced in any manner or disclosed to or discussed with any other parties without the express written permission of Associated Engineering Alberta Ltd. Information in this document is to be considered the intellectual property of Associated Engineering Alberta Ltd. in accordance with Canadian copyright law.

This report was prepared by Associated Engineering Alberta Ltd. for the account of City of Edmonton. The material in it reflects Associated Engineering Alberta Ltd.'s best judgement, in the light of the information available to it, at the time of preparation. Any use which a third party makes of this report, or any reliance on or decisions to be made based on it, are the responsibility of such third parties. Associated Engineering Alberta Ltd. accepts no responsibility for damages, if any, suffered by any third party as a result of decisions made or actions based on this report.

TABLE OF CONTENTS

SECTION	PAGE NO.
Table of Contents	i
1 Introduction	1
2 Background	1
2.1 Site Description	1
2.2 Field Survey Methods and Results	2
3 Mitigation Measures	4
3.1 Alternative Bat Habitat	4
3.2 Bridge Exclusion Methods	5
3.3 Construction Mitigation Measures	6
Closure	
References	
Appendix A – Figures	
Appendix B – Bat Box Design	

1 INTRODUCTION

Wellington Bridge, constructed in 1932, is a three-span concrete arch bridge that carries 102 Avenue NW over the Ramsay Ravine in Edmonton, Alberta. The bridge is in poor condition and has reached the end of its lifespan. Since 2014, the bridge has been supported by a temporary falsework system to safely maintain vehicular traffic until the bridge is replaced. The City of Edmonton (the City) retained Associated Engineering Alberta Ltd. (Associated) to complete preliminary design, detailed design, resident engineering, and post-construction services for the replacement of the Wellington Bridge at 102 Avenue NW over the Ramsay Ravine, including the shared use path (the Project). As the Ramsay Ravine is part of the North Saskatchewan River Valley and within the North Saskatchewan River Valley Area Redevelopment Plan, Bylaw 7188 (City of Edmonton 2018), an environmental impact assessment (EIA) was completed for the Project in September 2021.

As part of the EIA, Associated's Erin Cawthorn, BIT, and Stephanie Findlay, P.Biol., conducted a bat survey on July 4, 2021. The survey identified bats roosting in the gaps, cracks, and expansion joint of Wellington Bridge. A maternity colony was identified in the expansion joint adjacent to the abutment on the east side of the bridge. In addition, other bats were observed roosting in a crack between the concrete on the underside of the bridge, west of the pedestrian pathway. A large amount of bat guano and two adult carcasses were identified beneath the maternity roost and were sent in for genetic testing. The DNA test results identified that the fecal matter and carcasses were associated with the little brown bat (*Myotis lucifugus*), which is protected provincially and federally. Little brown bat is listed as Threatened under Schedule 6 of the *Wildlife Regulation* and Endangered under the *Species at Risk Act*. The presence of a little brown bat maternity roost under the Wellington Bridge presents a unique situation, whereby the Project will permanently remove vital habitat during critical life stages for the species. Therefore, the Project cannot proceed until mitigation measures have been developed to protect the bats. The City retained Associated to develop a mitigation plan to prevent harm to the little brown bat and provide it with supplemental habitat during bridge replacement activities.

2 BACKGROUND

2.1 Site Description

Wellington Bridge is located in SE 01-053-25 W4M of the Alberta Township System and exists within in the North Saskatchewan River Valley and Ravine System overlay. The bridge crosses over the Ramsay Ravine at 102 Avenue NW between Wellington Crescent NW and Churchill Crescent NW, on lands that are owned by the City.

Land uses in the Project area include vehicular and pedestrian transportation on 102 Avenue NW, natural forested areas of the Ramsay Ravine, an unnamed watercourse at the bottom of the ravine (waterbody ID 44445), and recreational activities on the multi-use trail at the bottom of the ravine. Well-established residential communities exist east and west of the Ramsay Ravine. Wellington Bridge provides an important transportation connection to the City's downtown core. Zoning of the lands in the Project area includes Metropolitan Recreation Zone (A), Public Parks Zone (AP), and Single Detached Residential Zone.

The Ramsay Ravine is a forested, meandering valley. The east and west banks of the ravine consist of steep, heavily forested slopes that flatten out toward the centre. The centre of the ravine is relatively flat and contains a shared-use path to the east of an unnamed watercourse (waterbody ID 44445) that bisects Wellington Bridge.

Slopes in the Project area are approximately 3H:1V, and some sections approach 2H:1V (Thurber Engineering Ltd. 2021). Slope stability and erosion issues throughout the Ramsay Ravine have resulted in four landslide areas in and immediately adjacent to the Project area.

As per the City's Urban Primary Land and Vegetation Inventory, the Project area consists of naturally wooded areas classified as forested stand types and developed areas classified as established residential communities (City of Edmonton 2024). In the Project area, an open area of maintained grass exists at the crest of the ravine on the southeast side of Wellington Bridge. Northwest of Wellington Bridge, outside the Project area, another open area of maintained grass exists where the shared-use path from the ravine connects with Churchill Crescent NW. Landscape trees grow along 102 Avenue NW, Churchill Crescent NW, and Wellington Crescent NW.

The forested areas surrounding the Wellington Bridge are deciduous dominated, while the understory is dominated by shrubs. Herbaceous plants in the Project area are limited due to the dense shrub layer. The vegetation in the Project area is characteristic of an area that has been influenced by human disturbance, given the occurrence and cover of many non-native species. With regard to wildlife habitat quality, most of the land in the Project area is considered moderate to high value, as per the City's Environmental Sensitivities database (City of Edmonton 2016). Small areas in the Project area are considered very high and extremely high wildlife habitat value. The existing bridge structure provides passage for wildlife, frequently used by birds and small- to medium-sized mammals.

2.2 Field Survey Methods and Results

The EIA identified bats roosting in the gaps and cracks of Wellington Bridge. Therefore, a bat survey was conducted to determine the nature of the bat roost in the bridge structure.

The bat survey was completed on July 4, 2021 to determine the presence or absence of bat roosts in the bridge structure. The survey included the use of passive and active acoustic detectors and infrared cameras. The survey methods followed those in the Handbook of Inventory Methods and Standard Protocols for Surveying Bats in Alberta (AFWD 2010). Additional surveys were completed by the City in 2023 and included acoustic and fecal analysis (Mazur 2024).

The bat survey identified a maternity colony roost in expansion joint adjacent to the abutment on the east side of the bridge. Degraded pieces of foam along the east abutment created the void space for the maternity colony. In addition to using the expansion joint as a maternity roost, bats were also using cracks between the concrete on the underside of the bridge, west of the pedestrian pathway, as a roost. Foam pieces along the west abutment appear in better condition and there is less void space available.

A large amount of guano had accumulated beneath the maternity colony roost at the east bridge abutment, indicating frequent use by many individuals and reuse over several years. Two live bat pups, one female and one male, were observed below the maternity colony roost at the east bridge abutment. These pups were young-of-the-year and non volant. One pup was retrieved by the mother after sunset.

At least 26 individuals were counted during the point count survey on July 4, 2021, although the maternity colony roost likely contains more individuals. Based on the frequency of the echolocation calls, at least two species of bats appeared to be using the maternity colony roost. Low-frequency calls (i.e., 20–40 kHz) indicate a large-bodied bat species, and high-frequency calls (i.e., 50–80 kHz) indicate a small-bodied bat species. Low- and high-frequency echolocation calls were both recorded emerging from the maternity roost. Two adult carcasses of a small-bodied bat

species were located at the base of the maternity colony roost; however, these species could not be identified in the field. Carcasses and feces were collected for species identification through genetic testing. After the 2023 surveys, the City identified accumulated guano along the west abutment expansion gap, and additional acoustic surveys identified additional bat species in the ravine, including the hoary bat (*Lasiurus cinereus*).

The bat carcasses and feces were sent to Northern Arizona University for metabarcoding. The genetic testing detected only the little brown bat. Little brown bat is federally and provincially protected. This species is listed as Threatened under Schedule 6 of the *Wildlife Regulation*. Further, it is listed as Endangered under the *Species at Risk Act*; therefore, the roosting locations in Wellington Bridge are considered critical habitat. The Project will result in the loss of habitat for maternity roosting bats once the bridge is demolished. Thus, a mitigation plan, including long-term and short-term strategies, must be developed to provide long-term roosting habitat and reduce the impacts of the Project on little brown bat maternity roosting activities.

2.2.1 Life History of Little Brown Bat

Little brown bats are small, brown bats with black ears, wings, and a tail membrane (van Zyll de Jong 1985). They weigh approximately 7–9 g and have a wingspan of approximately 22–27 cm, with females slightly larger than males (Harvey et al. 2011). Their diet can vary significantly based on geographic location; however, they generally feed nocturnally on insects (e.g., moths, mayflies, flies, beetles, and caddisflies) and spiders (Moosman et al. 2012, Clare et al. 2014).

In Canada, little brown bats have been confirmed in every province and territory, except for Nunavut. The Canadian populations of little brown bats generally use the boreal forest south of the treeline, down to the US border (COSEWIC 2013). The habitat requirements for little brown bats vary seasonally and consist of overwintering habitat (for hibernation and overwinter survival); summering habitat, including roosts (i.e., maternity roosts and night roosts) within commuting distance of foraging habitat; and swarming habitat for late summer and early fall mating and socializing (Norquay et al. 2013, Randall and Broders 2014). Wellington Bridge consists of summer roosting habitat for little brown bats but does not provide suitable overwintering habitat. Therefore, only roosting habitat is relevant to the Project and is the only habitat type explored in this report.

Roosts provide thermal regulation and shelter from weather and predation and can be the sites for interaction (Barclay and Kurta 2007). Roost selection is a function of numerous characteristics occurring at a range of spatial scales, including roosting structure, stand-scale, and landscape scale effects (Fabianek et al. 2011). Little brown bats use buildings and other anthropogenic structures (e.g., bridges, bat boxes) to roost; however, they also use natural features if suitable ones exist (Slough 2009, Randall et al. 2014).

Females choose suitable maternity roosts at the expense of travelling longer distances to forage, indicating a limited number of suitable maternity sites (Randall et al. 2014). Female little brown bats show a high degree of philopatry, returning to the same natural maternity roost sites for upwards of 10 years and anthropogenic structures for upwards of 50 years (COSEWIC 2013). Maternity colonies are used for giving birth and raising pups and are usually active in the spring/summer, and inactive in the fall/winter (Figure 1).

Major threats to the little brown bat include residential and commercial development, agriculture and aquaculture, energy production and mining, transportation and service corridors, biological resource use, human intrusion and disturbance, natural system modification, invasive and other problematic species, and pollution (COSEWIC 2013).

3 MITIGATION MEASURES

3.1 Alternative Bat Habitat

Removing Wellington Bridge will result in the loss of roosting habitat for little brown bats in the Ramsay Ravine. This habitat loss may cause the existing maternity colony to disperse and move into adjacent residential properties or may cause them to harm other tree-roosting bat species in the ravine. Providing alternative habitat by installing bat boxes will offset the loss of habitat and promote roosting in locations away from residential areas (Miller 2018). Bat boxes must be designed in a way that provides suitable conditions to ensure individuals can reproduce successfully; otherwise, the colony may decline over time. Single-chambered boxes and rocket-style boxes do not appear to attract bats in urban settings and are not recommended as alternative habitat (Miller 2018). Multi-chambered bat boxes can support hundreds of bats and allow for movement within the roost to access warmer areas or prevent overheating (Alberta Community Bats 2023).

The following bat box design specifications are recommended when constructing bat boxes and were adapted as per the Holroyd et al. (2023) Best Management Practices for the Use of Bat Houses in the U.S. and Canada:

- Use a design similar to the Bat Conservation International's four-chambered nursery house (Appendix B).
- Design the box to a minimum of 61 cm tall and 43 cm wide.
- Use wood screws (exterior grade, weatherproof, stainless or galvanized steel, Teflon-coated). Bend or file off any exposed sharp edges.
- Construct boxes using 1 cm thick wood (exterior-grade plywood, pine, cedar, etc.); plastics and other synthetic materials do not provide sufficient insulation.
- Locate vertical landing strips below the entrance of the box.
- Ensure that the interior chamber spacing ranges between 1.9 cm and 2.5 cm.
- Cut or drill holes through the interior panels to allow for access to other chambers.
- Roughen or score wood with grooves on the landing strips and in the interior chambers to provide grip points for the bats.
- Paint or stain the exterior of the box with a dark colour to promote absorption of solar radiation. The paint/stain must be exterior grade and water based. Oil-based paints or stains contain high amounts volatile organic compounds and will deter or potentially harm bats.
- Seal (using caulking or glue) all seams to limit heat loss and prevent water penetration.

Bat boxes should be placed near the same ravine as the existing maternity roost but far enough to avoid disturbance while the bridge is removed and reconstructed. Bridge construction activities will present a high degree of disturbance and may act as a physical barrier in the ravine. As a result, bat boxes must be placed at least 150 m south of the bridge structure to limit disturbance during construction, retain fidelity to the ravine, and allow access to the North Saskatchewan River. Tree-roosting bat species, such as the northern long-eared bat (*Myotis septentrionalis*), may also roost in the ravine, and individuals displaced from the bridge structure may harm other resident species. It is not recommended to scatter bat boxes throughout the ravine as it will increase competition for other bat species in the area (Olson 2024).

The following bat box installation specifications are recommended when placing the bat boxes and were adapted as per the Holroyd et al. (2023) Best Management Practices for the Use of Bat Houses in the U.S. and Canada:

- Install bat boxes in the suitable areas identified in Figure 2. Exact locations must be approved by the City project manager.
- Install boxes between March 1 and May 31, 2024, before the bats arrive from their overwintering habitat.
- Consider installing four bat boxes to mitigate for the loss of the maternity roost.
- Mount boxes on poles as much as possible.
- Install boxes 3 to 5 m above the ground surface to protect from ground predators and human interference.
- Install boxes away from tree limbs or large perches. Prune adjacent limbs or perches if necessary.
- Install predator-detering features, such as bird spikes and sheet metal wraps.
 - Sheet metal wraps should be at least 1 m off the ground.
- Place bat boxes away from areas illuminated by street lights.
- Install boxes individually or with two boxes placed back-to-back.
- Install boxes in areas with varying degrees of solar exposure (i.e., sunny, south-facing areas and shady areas) to provide habitat for species with differing ecological requirements.

3.2 Bridge Exclusion Methods

By law in Alberta, bats cannot be excluded from any structure, including bridges, during periods when females are raising their pups (GoA 2024). For maternity roosts, female bats typically arrive mid-March and give birth in June (Alberta Community Bats 2019). Pups are born non volant (they cannot fly) and remain in the roost overnight when females emerge to forage or drink (Altringham 2011). Using exclusion materials is not permitted once the pups have been born as these measures will trap individuals within the bridge structure (GoA 2024). By late summer, pups begin to fly; however, they continue to return to the maternity roost until mid-September, when the females and young-of-the-year migrate to their overwintering habitat. These are general timing windows, and the arrival and departure of bats can vary if seasonal temperatures are not suitable for spring or fall migration.

Based on the proposed Project schedule, bridge removal activities are anticipated to begin in August 2025, directly affecting the active period for the maternity roost. To avoid affecting roosting bats, implement exclusion measures in fall or winter 2024, after females and young-of-the-year have left the roost. The following exclusion practices should be adhered to and were developed as per the Best Management Practices for Bats in British Columbia: Chapter 9 Bridges (BC Ministry of Environment and Climate Change Strategy 2022) guidelines:

- Do not undertake exclusion activities while the roost is occupied (mid-March to mid-September).
- Conduct a wildlife survey no more than 7 days before installing exclusion measures.
 - If a wildlife survey cannot confirm that roosts are vacant, postpone exclusion activities until overnight temperatures fall below freezing for at least 1 week concurrently.
- Retain a qualified environmental professional to supervise the installation of bat exclusion measures.
- If a bat is discovered while exclusion measures are installed, stop work immediately and contact the site environmental professional determine additional mitigation measures.
- Fill roost entrances and any other potential roosting crevices with expanding foam, caulking, weather stripping, or sealant.
- Install netting, with mesh no larger than 3/8", under the entire of the bridge deck.
 - Avoid placing netting below any bridge drains to avoid damaging the net.
- Do not use toxic materials, sticky fly ribbon, or glue traps.

- Inspect exclusion materials on a regular basis, especially after heavy rain, snow, or high-wind events. Repair any damaged exclusion materials as soon as possible.
- If exclusion materials are damaged during periods when bats may be present, an additional wildlife sweep may be required to ensure bats have not circumvented the exclusion materials.
- Do not handle bats. Bats may be handled only by a qualified environmental professional with a recent rabies vaccination or antibody immunity testing.
- Handle all bat in accordance with the Government of Alberta's Alberta Wildlife Animal Care Committee Class Protocol #004 (2005) and the Addendum to Class Protocol #004: Bat Capture, Handling, and Release (2009).

3.3 Construction Mitigation Measures

The probability of encountering bats in the Ramsay Ravine during construction is high. The following mitigation measures are recommended during construction to limit direct and indirect impacts to bat species:

- Ensure all bridge construction activities, including site access routes, laydown areas, or stockpiling, are not located within 100 m of the bat boxes placed as alternative habitat.
- Schedule high-impact disturbance activities (i.e., demolition, vegetation clearing, piling) outside the sensitive species windows to avoid impacts.
- Avoid scheduling construction activities overnight between May 1 and August 31, where possible.
- Before the bridge is demolished, inspect exclusion materials regularly, especially after heavy rain, snow, or high-wind events. Repair any damaged exclusion materials as soon as possible.
- Inspect bat boxes for signs of vandalism or damage. Report any deficiencies to the site supervisor and City project manager.
- Avoid illuminating non-essential areas of the Project after sunset between May 1 and August 31.
 - Illumination may be a suitable deterrent to exclude bats from sensitive areas of the construction site.
- If a bat is discovered in the Project area (i.e., roosting on the side of equipment or on a structure), stop work and contact the site supervisor and/or project manager immediately.
 - A qualified environmental professional may need to relocate bats roosting on equipment or any construction structures before work resumes.
 - If a bat comes into direct contact with a worker, stop work and report the incident immediately. The worker may require medical attention.
- Report all bat sightings to the site supervisor, City project manager, and consulting engineer project manager.

CLOSURE

This report was prepared for the City of Edmonton to provide guidance with regard to the provisions of alternative bat habitat, bat exclusion activities, and construction mitigation measures.

The services provided by Associated Engineering Alberta Ltd. in the preparation of this report were conducted in a manner consistent with the level of skill ordinarily exercised by members of the profession currently practising under similar conditions. No other warranty expressed or implied is made.

Respectfully submitted,

Associated Engineering Alberta Ltd.



Stephanie Findlay, M.Sc., P.Biol.
Environmental Scientist



Shane Cote, P.Ag.
Manager, Environmental Planning and
Compliance

REFERENCES

- Alberta Community Bat Program. 2019. Managing Bats in Buildings: Alberta Guidelines. Available online: https://www.albertabats.ca/wp-content/uploads/Alberta_Bats_in_Buildings.pdf. Accessed February 13, 2024.
- Alberta Community Bat Program. 2023. Alberta Bat House Guidelines. Available online: https://www.albertabats.ca/wp-content/uploads/Alberta_Bat_House_Guidelines.pdf. Accessed February 14, 2024.
- Alberta Fish and Wildlife Division (AFWD). 2010. Handbook of Inventory Methods and Standard Protocols for surveying Bats in Alberta. Prepared by Maarten Vonhof.
- Altringham, J.D. 2011. *Bats: From Evolution to Conservation*. Second Edition. Oxford University Press. New York. 119 pp.
- Barclay, R. and A. Kurta. 2007. Ecology and behaviour of bats roosting in tree cavities and under bark. Pages 17-60 In M. J. Lacki, J. P. Hayes, and A. Kurta (eds.). *Bats in Forests: Conservation and Management*. John Hopkins University Press. Baltimore, MD.
- BC Ministry of Environment and Climate Change Strategy. 2022. Best Management Practices for Bats in British Columbia, Chapter 9: Bridges. BC Ministry of Environment and Climate Change Strategy, Victoria BC. 52 pp.
- Committee on the Status of Endangered Wildlife in Canada (COSEWIC). 2013. COSEWIC assessment and status report on the Little Brown Myotis *Myotis lucifugus*, Northern Myotis *Myotis septentrionalis* and Tri-colored Bat *Perimyotis subflavus* in Canada. Committee on the Status of Endangered Wildlife in Canada, Ottawa, ON.
- City of Edmonton. 2016. Environmental Sensitivity Project, Model data. Prepared for: The City of Edmonton, Alberta. Prepared by: Solstice Canada. Edmonton Alberta.
- City of Edmonton. 2018. North Saskatchewan River Valley Area Redevelopment Plan, Bylaw 7188.
- City of Edmonton. 2024. Urban Primary Land and Vegetation Inventory. Available online: <https://data.edmonton.ca/stories/s/uPLVI-Information-Portal/3fsu-hkrk/>. Accessed February 1, 2024.
- Clare, E., W.O.C. Symondson, H. Broders, F. Fabianek, E.E. Fraser, A. MacKenzie, A. Boughen, R. Hamilton, C.K.R. Willis, F. Martinez-Nuñez, A.K. Menzies, K.J.O. Norquay, M. Brigham, J. Poissant, J. Rintoul, R.M.R. Barclay, and J.P. Reimer. The diet of *Myotis lucifugus* across Canada: assessing foraging quality and diet variability. *Molecular Ecology* 23(15): 3618-3632.
- Government of Alberta (GoA). 2005. Alberta Wildlife Animal Care Committee Class Protocol #004. Wildlife Management Branch, Environment and Sustainability Resource Development.
- Government of Alberta (GoA) 2009. Addendum to Class Protocol #004: Bat Capture, Handling, and Release. Wildlife Management Branch, Environment and Sustainability Resource Development.

- Government of Alberta (GoA). 2024. Human Wildlife Conflict – Bats. Available online: <https://www.alberta.ca/bats>. Accessed February 13, 2024.
- Fabianek, F., D. Gagnon, and M. Delorme. 2011. Bat distribution and activity in Montréal Island green spaces: responses to multi-scale habitat effects in a densely urbanized area. *Ecoscience* 18(1): 9-17.
- Harvey, M.J., J.S. Altenbach, and T.L. Best. 2011. Bats of the United States and Canada. Johns Hopkins University Press. Baltimore, MD. 202 pp.
- Holroyd, S., C.L. Lausen, S. Dulc, E. de Freitas, R. Crawford, J. O’Keefe, C. Boothe, J. Segers, and J. Reichard. 2023. Best Management Practices for the Use of Bat Houses in US and Canada. Wildlife Conservation Society Canada, produced in cooperation with US Fish and Wildlife Service and Canadian Wildlife Health Cooperative for the WNS Conservation and Recovery Working Group. <https://ecos.fws.gov/ServCat/Reference/Profile/160034>.
- Miller, E. 2018. Day-Roost Selection by Alberta Bats in an Urban Environment. Available online: https://www.crossconservation.org/uploads/source/images/Erin_Miller- BatBoxes- Final_530_Paper2017.pdf. Accessed February 14, 2024.
- Moosman, P.R., H.H. Thomas, and J.P. Veilleux. 2012. Diet of the widespread insectivorous bats *Eptesicus fuscus* and *Myotis lucifugus* relative to climate and richness of bat communities. *Journal of Mammalogy* 93(2): 491-496.
- Mazur, Nikqueta. City of Edmonton Integrated Pest Management. February 12, 2024. Personal communication (virtual meeting) with Stephanie Findlay and Erica Graham of Associated.
- Norquay, K.J.O., F. Martinez-Nunez, J.E. Dubois, K.M. Monson, and C.K.R. Willis. 2013. Long-distance movements of little brown bats (*Myotis lucifugus*). *Journal of Mammalogy* 94(2): 506-515.
- Olson, Corey. Program Coordinator, Alberta Community Bat Program. February 13, 2024. Personal communication (email conversation) with Stephanie Findlay of Associated.
- Thurber Engineering Ltd. 2021. Wellington Bridge Replacement – Geotechnical Investigation. Edmonton, Alberta.
- Randall, J. and H.G. Broders. 2014. Identification and characterization of swarming sites used by bats in Nova Scotia, Canada. *Acta Chiropterologica* 16(1): 109-116.
- Randall, L.A., T.S. Jung, and R.M. Barclay. 2014. Roost-site selection and movements of Little Brown Myotis (*Myotis lucifugus*) in southwestern Yukon. *Northwestern Naturalist* 95(3): 312-317.
- Slough, B.G. 2009. Behavioral thermoregulation by a maternity colony of little brown bats in the Yukon. *Northwestern Naturalist*: 47-51.
- van Zyll de Jong, C.G. 1985. Handbook of Canadian Mammals: Bats. National Museum of Natural Sciences. Ottawa, ON. 212 pp.

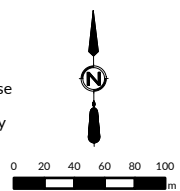
APPENDIX A – FIGURES



\\AE\CAD\DATA\WORKING\EDM\2020-3858-00\GIS\ARC\PROJ\WILD\HAB\AE20203858_BAT_HAB_REV0.APRX
 IMAGERY: ESRI, DIGITALGLOBE, GEOEYE, I-CUBED, USDA FSA, USGS, AEA, GETMAPPING, ROAD, STATISTICS CANADA, 2022, HYDROGRAPHY, ALTALIS LTD., 1994, ATIS GRID, ALTALIS LTD., 2020.



LEGEND	
	Alternative Habitat
	Bridge Footprint
	Buffer (150m)
	Highway
	Watercourse
	Water Body



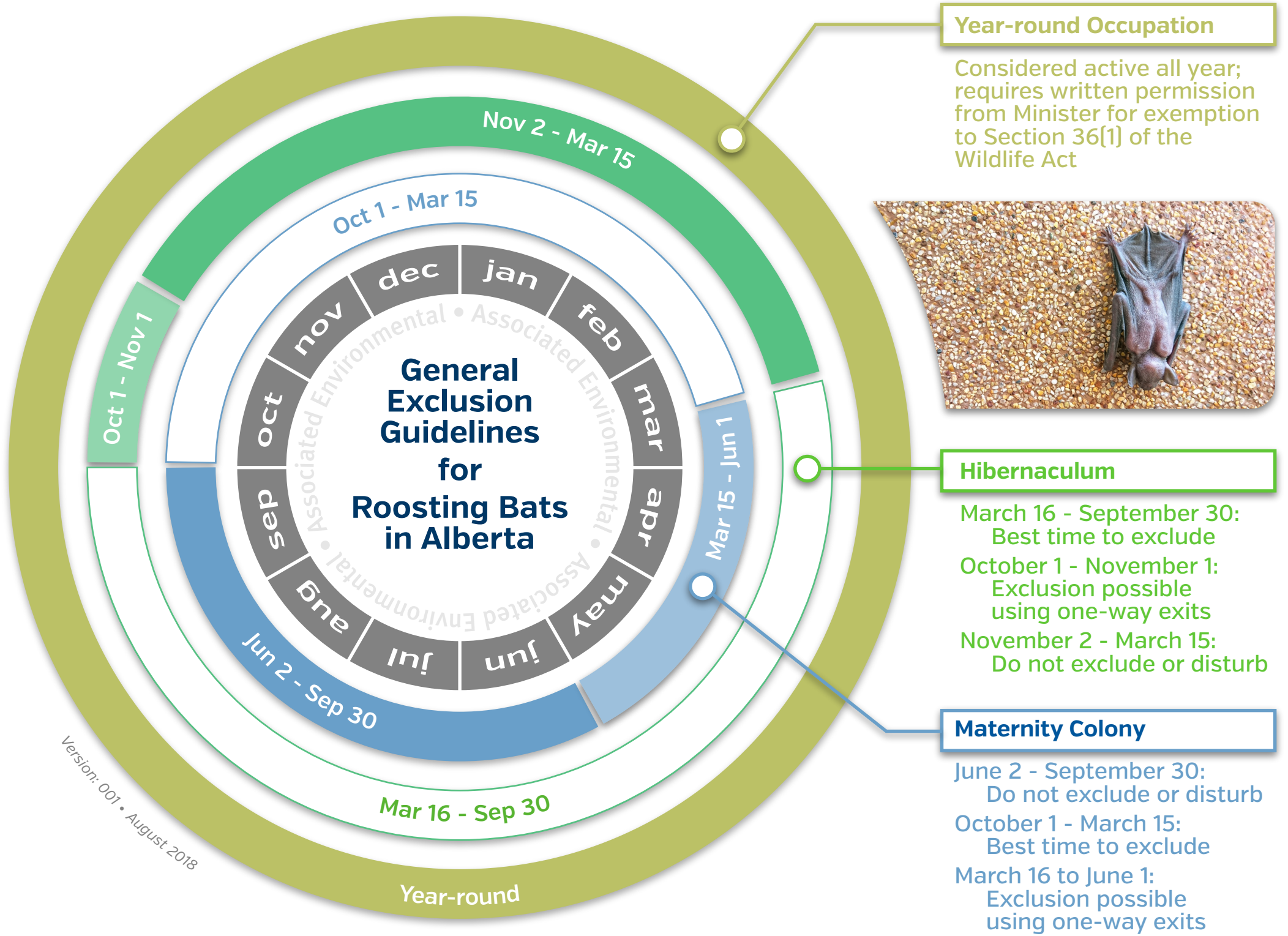
AE PROJECT NO. 2020-3858-00
 SCALE 1:5,000
 COORD. SYSTEM NAD 1983 3TM 114
 DATE 2024-03-05
 REV 00
 DRAWN BY WL
 CHECKED BY JL
 DESCRIPTION ISSUED FOR INFO

FIGURE 2
ALTERNATIVE HABITAT LOCATIONS

 CITY OF EDMONTON
 WELLINGTON BRIDGE REPLACEMENT

 BAT MITIGATION PLAN

Restrictions Based on Roost Type as Determined by Bat Survey



Version: 001 • August 2018

APPENDIX B – BAT BOX DESIGN

FIGURE 1
*Four-chamber
 Nursery House
 Assembly Diagrams*

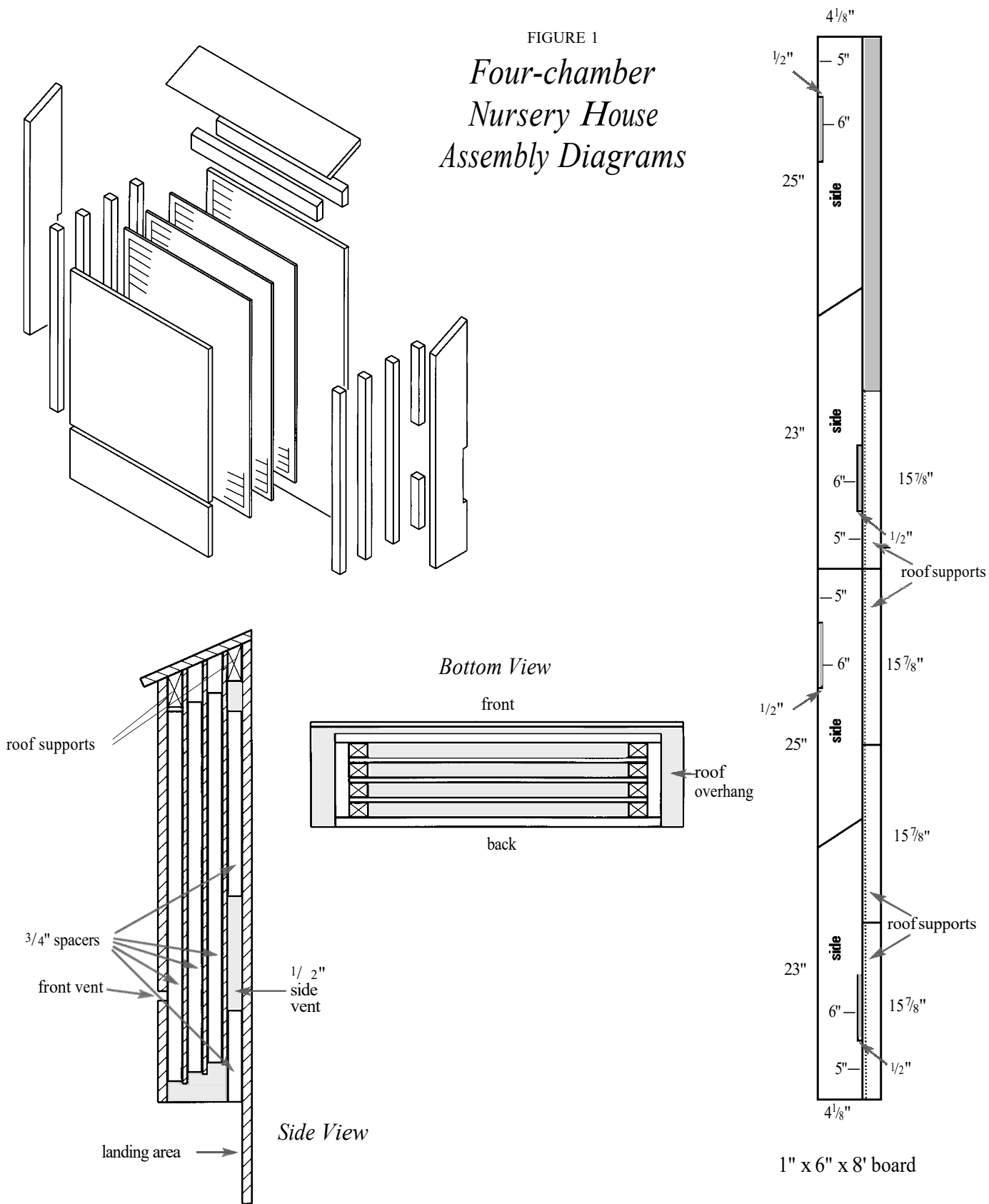
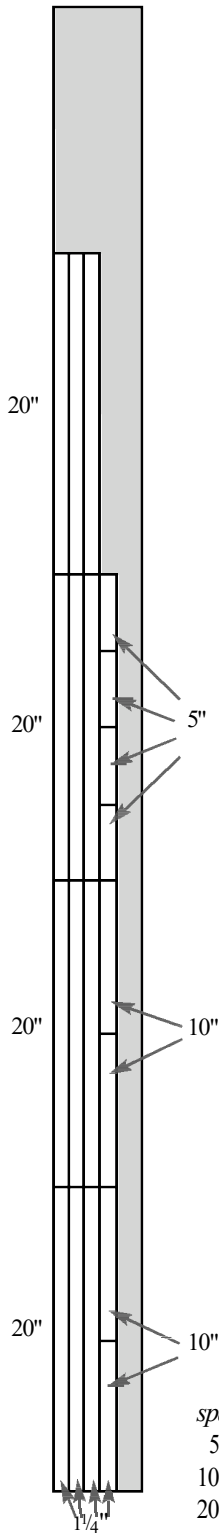


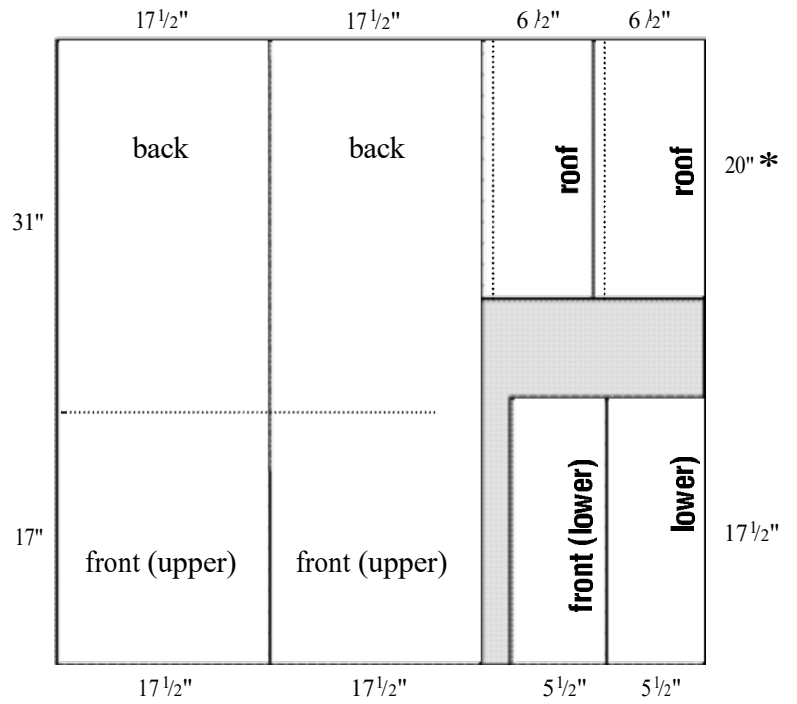
FIGURE 2
*Four-chamber
 Nursery House
 Sawing Diagrams*

extra material
 25 degree bevel



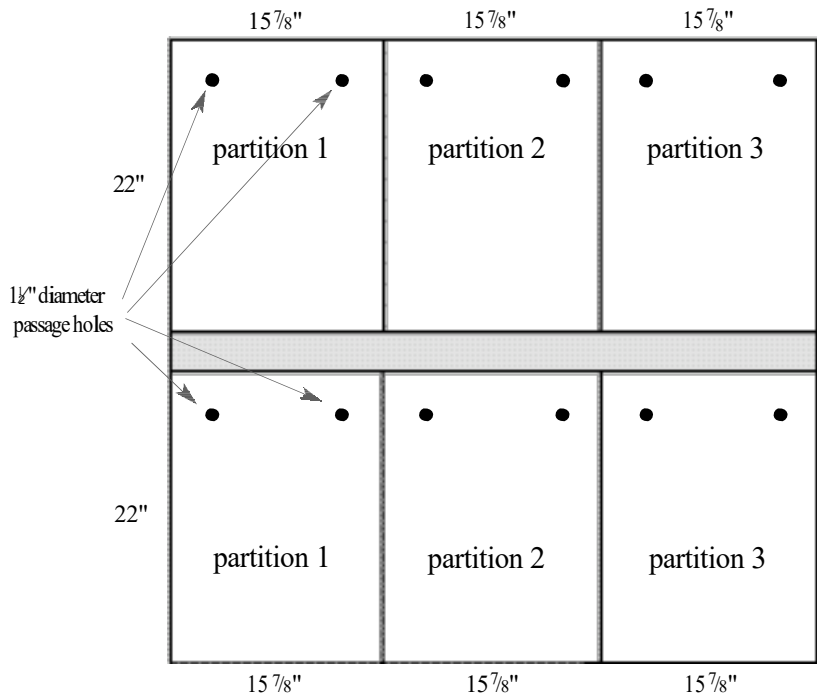
spacers:
 5" spacers = back bottom
 10" spacers = back top
 20" spacers = others

1" x 6" x 8' board



4' x 4' x 1/2" plywood

* 19" if mounted between two poles



4' x 4' x 3/8" plywood