

CR_6996 ATTACHMENT 1

**Mill Creek Ravine Park Trail
Rehabilitation, Edmonton,
Alberta**

Environmental Review Report



Prepared for:
City of Edmonton

Prepared by:
Stantec Consulting Ltd.

May 2019

1161106255

Sign-off Sheet

This document entitled Mill Creek Ravine Park Trail Rehabilitation, Edmonton, Alberta was prepared by Stantec Consulting International Ltd. ("Stantec") for the account of City of Edmonton (the "Client"). Any reliance on this document by any third party is strictly prohibited. The material in it reflects Stantec's professional judgment in light of the scope, schedule and other limitations stated in the document and in the contract between Stantec and the Client. The opinions in the document are based on conditions and information existing at the time the document was published and do not take into account any subsequent changes. In preparing the document, Stantec did not verify information supplied to it by others. Any use which a third party makes of this document is the responsibility of such third party. Such third party agrees that Stantec shall not be responsible for costs or damages of any kind, if any, suffered by it or any other third party as a result of decisions made or actions taken based on this document.

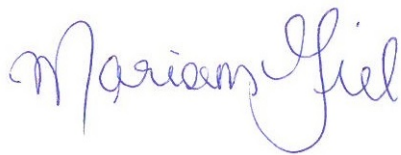

Prepared by _____

(signature)

Mariam Gill, BES
Environmental Scientist



Technical Review by _____

(signature)

Stephanie Grossman, M. Sc., P.Biol
Environmental Scientist



Senior Review by _____

(signature)

Elaine Little, B.Sc.
Associate, Project Manager



Table of Contents

1.0	INTRODUCTION	1.1
1.1	SPATIAL AND TEMPORAL BOUNDARIES	1.1
1.2	DESCRIPTION OF SITES.....	1.2
1.2.1	Site 1.....	1.2
1.2.2	Site 2.....	1.2
1.2.3	Site 3.....	1.2
2.0	PROJECT OVERVIEW	2.1
2.1	PROJECT DESCRIPTION	2.1
2.2	PROJECT ALTERNATIVES	2.1
2.2.1	Site 1.....	2.2
2.2.1.1	Alternative 1: Upgrade to existing unmaintained path	2.2
2.2.1.2	Alternative 2: Establish new trail which ties into the existing unmaintained path	2.2
2.2.1.3	Alternative 3 (Recommended): Hybrid alignment incorporating elements of Alternative 1 and 2	2.3
2.2.2	Site 2.....	2.3
2.2.2.1	Alternative 1: Upgrade Existing Unmaintained Trail	2.3
2.2.2.2	Alternative 2: Short Radius Trail with Retaining Wall.....	2.4
2.2.2.3	Alternative 3 (Recommended): Long Radius Trail with Retaining Wall.....	2.4
2.2.3	Site 3.....	2.4
2.2.3.1	Alternative 1: Minor trail realignment.....	2.5
2.2.3.2	Alternative 2: Major trail realignment.....	2.5
2.2.3.3	Alternative 3 (Recommended): Rehabilitating the existing trail and creek bank restoration	2.5
2.3	CONSTRUCTION ACTIVITIES	2.6
2.3.1	Access and Site Preparation	2.6
2.3.2	Construction Components.....	2.6
2.3.2.1	ESC Measures.....	2.6
2.3.2.2	Vegetation Clearing	2.7
2.3.2.3	Bank Armouring and Post and Rail Fence Installation.....	2.7
2.3.2.4	Trails and Granular Swales.....	2.7
2.3.2.5	Retaining Walls.....	2.7
2.3.2.6	Abandonment of Existing Trails	2.7
2.3.3	Rehabilitation	2.7
2.3.4	Operations and Maintenance	2.8
3.0	REGULATORY CONSIDERATIONS	3.1
4.0	EXISTING CONDITIONS	4.1
4.1	DESKTOP REVIEW	4.1
4.2	HYDROLOGY	4.2
4.3	GEOLOGY AND SOILS	4.2
4.4	VEGETATION	4.2



4.4.1	Desktop Review	4.3
4.4.1.1	ACIMS	4.3
4.4.1.2	Rare Plant Survey.....	4.3
4.5	WILDLIFE.....	4.5
4.5.1	FWMIS	4.6
4.5.2	COE City Wide Environmental Sensitivity Analysis	4.6
4.6	FISH AND FISH HABITAT	4.9
4.7	SOCIO-ECONOMIC ENVIRONMENT	4.9
4.7.1	Historical Imagery Review	4.9
4.7.2	Land Use.....	4.9
4.7.3	Coal Mines	4.9
4.7.4	Archaeological and Historical Resources	4.9
5.0	ASSESSMENT METHODS	5.1
5.1	VALUED COMPONENTS AND POTENTIAL PROJECT INTERACTIONS.....	5.1
5.2	RESIDUAL ENVIRONMENTAL EFFECTS ASSESSMENT	5.2
6.0	ENVIRONMENTAL EFFECTS ASSESSMENT.....	6.1
6.1	HYDROLOGY AND WATER QUALITY	6.3
6.1.1	Potential Effects	6.3
6.1.2	Mitigation Measures	6.3
6.1.3	Residual Effects	6.3
6.2	GEOLOGY, SOILS AND GEOMORPHOLOGY	6.4
6.2.1	Potential Effects	6.4
6.2.2	Mitigation Measures	6.4
6.2.3	Residual Effects	6.5
6.3	VEGETATION	6.5
6.3.1	Potential Effects	6.5
6.3.2	Mitigation Measures	6.6
6.3.3	Residual Effects	6.7
6.4	WILDLIFE.....	6.7
6.4.1	Potential Effects	6.7
6.4.2	Mitigation Measures	6.8
6.4.3	Residual Effects	6.9
6.5	FISH AND FISH HABITAT	6.9
6.5.1	Potential Effects	6.9
6.5.2	Mitigation Measures	6.10
6.5.3	Residual Effects	6.11
6.6	NOISE.....	6.11
6.6.1	Potential Effects	6.11
6.6.2	Mitigation Measures	6.12
6.6.3	Residual Effects	6.12
6.7	AESTHETICS.....	6.12
6.7.1	Potential Effects	6.12
6.7.2	Mitigation Measures	6.12
6.7.3	Residual Effects	6.13
6.8	ARCHAEOLOGICAL AND HISTORIC RESOURCES.....	6.13



6.8.1	Potential Effects	6.13
6.8.2	Mitigation Measures	6.13
6.8.3	Residual Effects	6.13
7.0	LIMITATIONS AND QUALIFICATIONS.....	7.1
8.0	REFERENCES.....	8.1

LIST OF TABLES

Table 3-1	Regulatory Considerations	3.1
Table 4-1	Summary of ACIMS Database Search Results	4.3
Table 4-2	Species of Management Concern Present within a 1 km Radius of the LAAs	4.6
Table 5-1	Potential Interactions between the Project Activities and Valued Components.....	5.2
Table 5-2	Residual Effect Characterization Definitions.....	5.3
Table 6-1	Residual Effect Characterization Summary for VCs	6.2

LIST OF FIGURES

Figure 1	Site Location Plan	1.3
Figure 2	Site 1 Details.....	1.4
Figure 3	Site 2 Details.....	1.5
Figure 4	Site 3 Details.....	1.6
Figure 5	Environmental Sensitivities (Solstice 2017).....	4.8

LIST OF APPENDICES

APPENDIX 1	PRELIMINARY DRAWINGS	1.1
APPENDIX 2	SITE ASSESSMENT & DESIGN ANALYSIS REPORT	2.1
APPENDIX 3	RARE PLANT SURVEY	3.1
APPENDIX 4	GEOTECHNICAL INVESTIGATION.....	4.1



1.0 INTRODUCTION

The City of Edmonton (COE; the City) retained Stantec Consulting Ltd. (Stantec) to complete an Environmental Review Report (ERR) for activities associated with the relocation of three sections of trail in Mill Creek Ravine Park that are deteriorating due to extensive trail use and natural creek bed erosion (the Project). The Project involves trail realignment at Site 1 (NE 28-052-24 W4M) and Site 2 (SE 28-052-24 W4M), and creek bank restoration at Site 3 (SE 28-052-24 W4M) (Figure 1). All three sites are located on the east bank of Mill Creek in Edmonton, AB. Mill Creek is a tributary which extends south and generally flows north into the North Saskatchewan River (NSR).

Mill Creek Ravine Park Trail is a well-loved green space and recreational area. However, the effects of creek erosion, has compromised the integrity and stability of the trail system. The trail system in Mill Creek Ravine Park requires rehabilitation as Mill Creek continues to erode it. The rehabilitation is meant to ensure that Edmontonians continue to enjoy the trails safely well into the future.

The Project is located within the *North Saskatchewan River Valley Area Redevelopment Plan* (NSRVARP) (City of Edmonton Bylaw 7188 [COE 2017c]) and requires that an ERR be completed for the proposed work. This report provides the results of the ERR; a Site Location Study (SLS) will be submitted under separate cover. The scope of this ERR is to:

- Review background information including existing reports, historical air photos, regulatory policies and regulations that may apply to the Project
- Develop an understanding of the existing baseline conditions within the spatial boundaries as described below in section 1.1 Spatial and Temporal Boundaries
- Review the proposed development concept in the context of the existing baseline conditions to identify potential effects to the environment
- Develop a mitigation plan to reduce potential effects of the Project to the environment

This assessment was conducted in accordance with the requirements of the NSRVARP and the *Guide to Environmental Review Requirements on the North Saskatchewan River Valley and Ravine System* (COE 2000). The potential effects, mitigation measures and residual effects (Section 6.0) are based on the development concept received on May 28, 2018.

1.1 SPATIAL AND TEMPORAL BOUNDARIES

The potential environmental effects of the Project have been assessed by considering the spatial boundaries reflecting the geographic area over which the effects may occur, and the temporal boundaries identifying when the effect may occur. Spatial boundaries have been determined for each of the three Sites that the Project is comprised of. The spatial boundaries for the Project are:

- **Project Development Area (PDA):** defined as the area in which Project activities will occur, and a direct physical disturbance is expected; including temporary and permanent disturbances. The PDA is synonymous with the Limit of Construction as identified in the Drawings (Appendix 1).



MILL CREEK RAVINE PARK TRAIL REHABILITATION, EDMONTON, ALBERTA

Introduction
May 2019

- **Local Assessment Area (LAA):** defined as an area extending 200 metre (m) buffer from the PDA boundary within which the environmental effects of the Project are assessed. The LAA may vary for different valued components (VCs). A 200 m buffer was used for hydrology, soils, and socio-economic environment, while a 1 km buffer was used for vegetation, wildlife and fish and fish habitat as the effects are anticipated to occur within a larger area.

The temporally boundaries for the Project are the construction phase and the operational (or post-construction) phase. Construction of the Project is anticipated to begin between fall of 2019 and fall of 2020, pending approvals, and last approximately two to four weeks at each Site following commencement.

1.2 DESCRIPTION OF SITES

Generally, the trail extends in a north south direction along both the east and west side of Mill Creek with numerous bridge crossings. The three sites requiring trail rehabilitation are located on the east side of Mill Creek between 92 Ave and 76 Ave NW (Figure 1). Site descriptions from the Site Assessment & Design Analysis Report (Stantec 2018a) and the Geotechnical Report (Stantec 2018b) are summarized below.

1.2.1 Site 1

Site 1 is located approximately 250 m northwest of 95 St and 90 Ave and 20 m south of Bridge 277. The Site is generally flat to gently rolling, and there is a slightly raised terrace at the base of the NSRV wall. The trail is at the base of the ravine along the top of the creek bank on the east side of the creek. The east bank of the creek has eroded, resulting in a 1.5 m to 3.5 m high cut bank. The trail follows the outside bend of the meander, which is currently being undercut by the creek. The creek encounters the bank at a nearly 90° angle (Figure 2). This cut bank has consumed approximately 10 m of the path, rendering it effectively impassable. While the trail is currently closed at this location, public access to the eroded section is still available. There is a secondary single-track trail as well as an unmaintained trail which traverse the treed area upslope and east of the main trail.

1.2.2 Site 2

Site 2 is located approximately 90 m north of 82 Ave and 150 m east of 95A St where the existing 2 m gravel trail follows the crest of a semi-active landslide (Figure 3). Site 2 is approximately 900 m south of Site 1. There is a steep hill to the east of the existing trail. Mill Creek turns 90° at the toe of the slope below the existing trail, which has resulted in a 10 m high cut bank where the trail traverses the crest. Approximately 7 m of the existing trail is currently protected by timber rail, but ongoing toe erosion may cause a slide which will inevitably render the existing trail impassable. There is an existing unmaintained trail upslope and east of the main trail.

1.2.3 Site 3

Site 3 is located approximately 135 m southwest of 78 Ave and 93 St, roughly 30 m north of Bridge 207, approximately 800 m south of Site 2 (Figure 4). The Site is generally rolling, with a knob immediately east of the existing trail. At Site 3, the existing trail has been narrowed from 3 m to 2 m over a length of 6 m where Mill Creek has eroded the east bank.



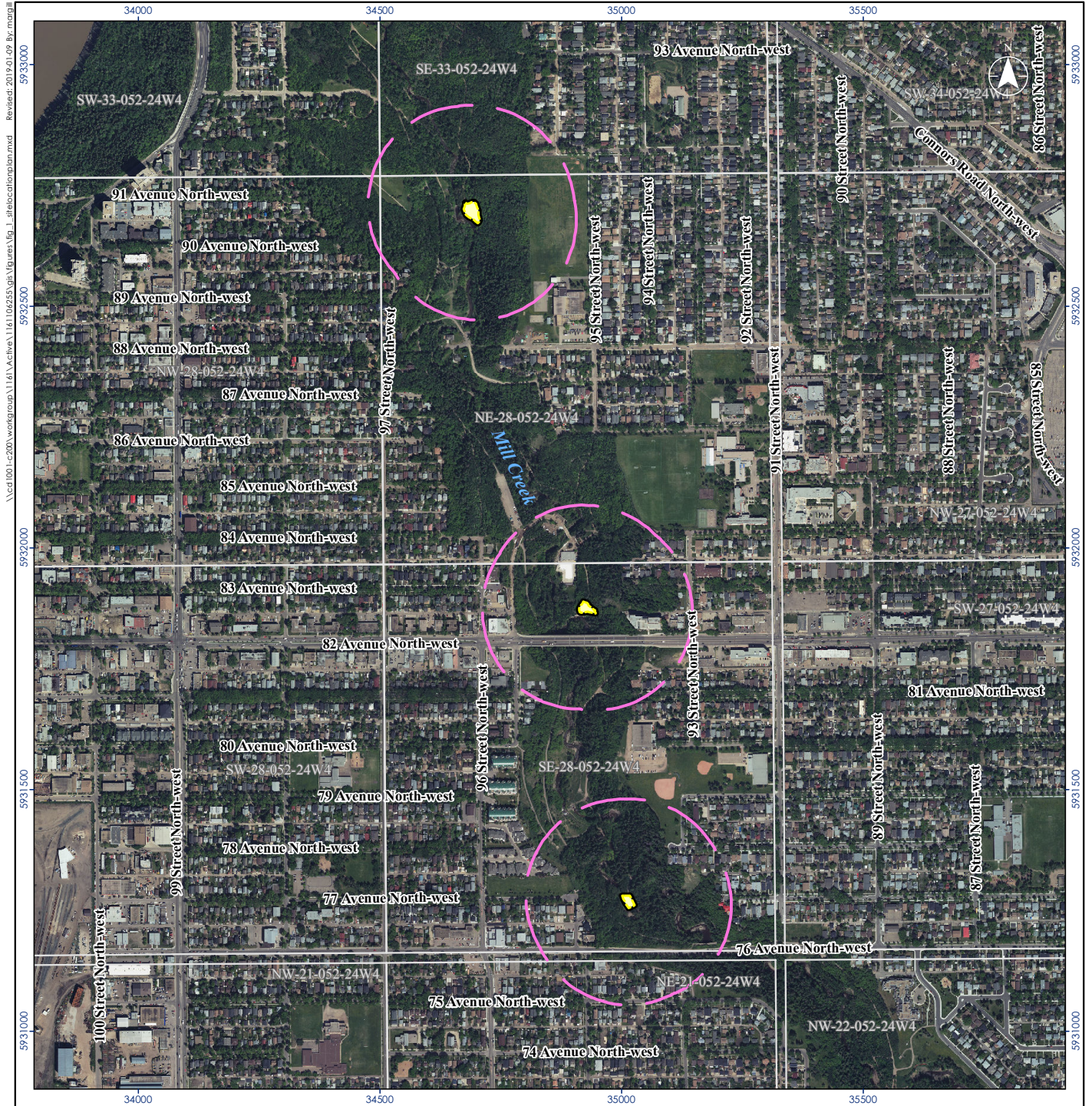

- Project Disturbance Area (PDA)
- Local Assessment Area (LAA)
- Quarter Section

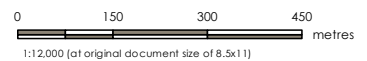

Project Location: Edmonton, AB
 1161106255
 Prepared by MG on 2018-11-14
 Quality Review by DJ on 2019-01-08
 Approved by EL on 2019-01-08

Client/Project:
 City of Edmonton
 Mill Creek Ravine Park Trail Rehabilitation
 Environmental Review Report





Figure No.
1

Title
Site Location Plan

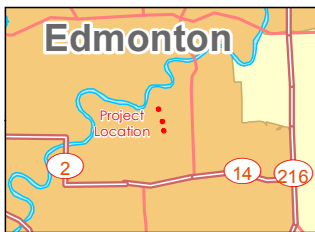
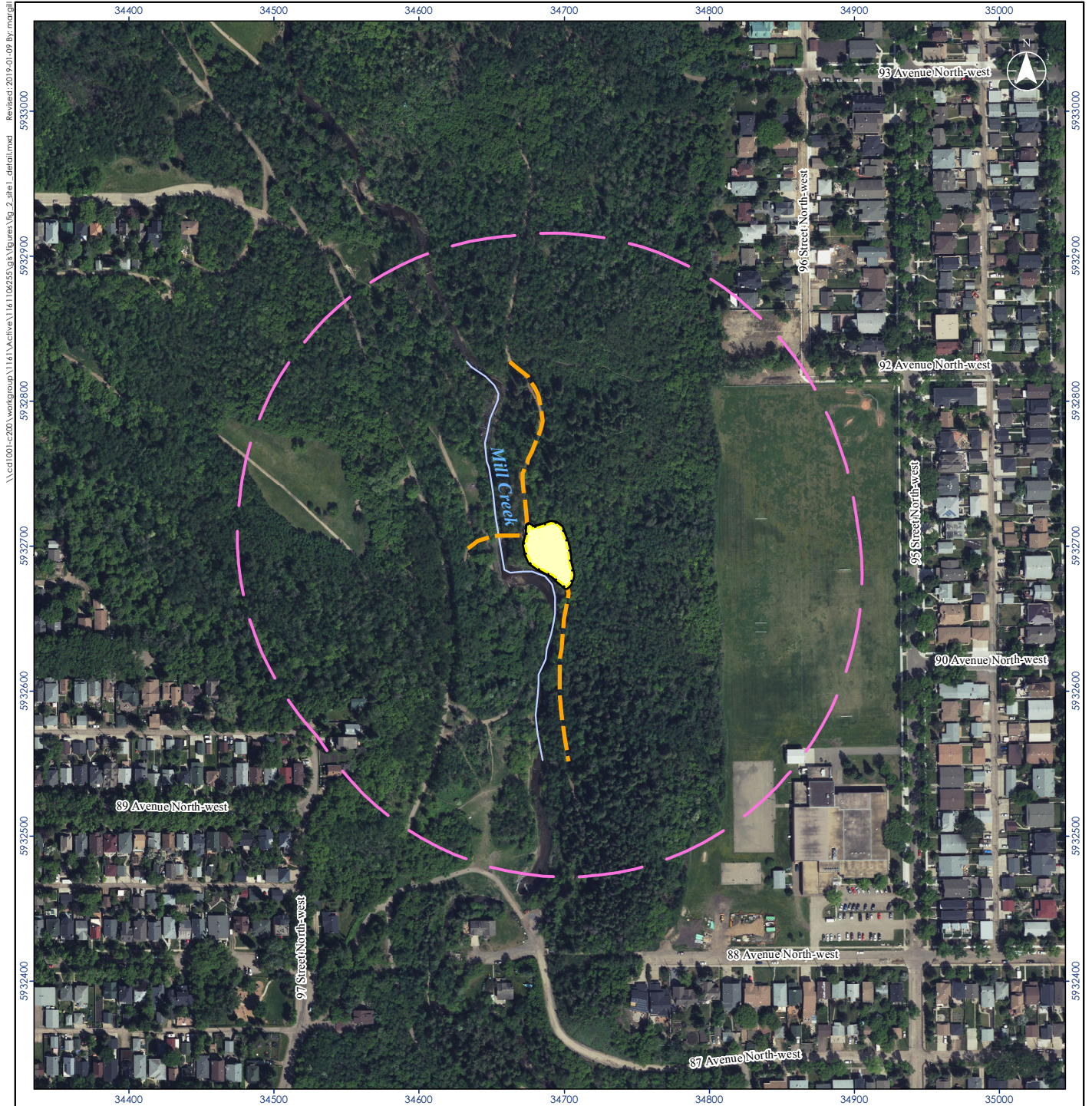
- Notes**
1. Coordinate System: NAD 1983 3TM 114
 2. Base features: Geogras, ©Department of Natural Resources Canada. All rights reserved.
 3. Imagery: City of Edmonton, 2017.

Disclaimer: Stantec assumes no responsibility for data supplied in electronic format. The recipient accepts full responsibility for verifying the accuracy and completeness of the data. The recipient releases Stantec, its officers, employees, consultants and agents, from any and all claims arising in any way from the content or provision of the data.



-  Project Disturbance Area (PDA)
-  Local Assessment Area (LAA)
-  Existing Main Trail
-  Mill Creek



Project Location: NE 28-052-24 W4M, Edmonton, Alberta
 Prepared by MG on 2018-11-14
 Quality Review by DJ on 2019-01-08
 Approved by EL on 2018-01-08

Client/Project: City of Edmonton
 Mill Creek Ravine Park Trail Rehabilitation
 Environmental Review Report

Figure No. 2

Title: Site Location Plan (Site 1)

- Notes**
1. Coordinate System: NAD 1983 3TM 114
 2. Base features: Geographics, ©Department of Natural Resources Canada. All rights reserved.
 3. Imagery: City of Edmonton, 2017.

Disclaimer: Stantec assumes no responsibility for data supplied in electronic format. The recipient accepts full responsibility for verifying the accuracy and completeness of the data. The recipient releases Stantec, its officers, employees, consultants and agents, from any and all claims arising in any way from the content or provision of the data.

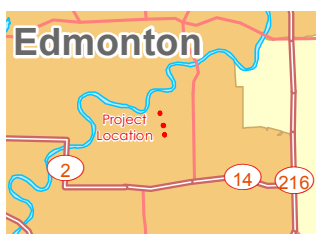

- Project Disturbance Area (PDA)
- Local Assessment Area (LAA)
- Existing Main Trail
- Mill Creek

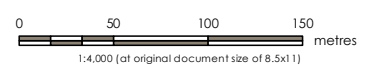

Project Location: SE 28-052-24 W4M, Edmonton, Alberta
 Prepared by MG on 2018-11-14
 Quality Review by DJ on 2019-01-08
 Approved by EI on 2019-01-08

Client/Project: City of Edmonton
 Mill Creek Ravine Park Trail Rehabilitation
 Environmental Review Report

Figure No. **3**

Title: **Site Location Plan (Site 2)**

- Notes**
1. Coordinate System: NAD 1983 3TM 114
 2. Base features: Geographics, ©Department of Natural Resources Canada. All rights reserved.
 3. Imagery: City of Edmonton, 2017.

Disclaimer: Stantec assumes no responsibility for data supplied in electronic format. The recipient accepts full responsibility for verifying the accuracy and completeness of the data. The recipient releases Stantec, its officers, employees, consultants and agents, from any and all claims arising in any way from the content or provision of the data.



\\ed1001-c200\workgroups\1161\Active\1161106225\Map\Figures\Fig_4_site3_detailed.mxd Revised: 2019-01-09 By: marci

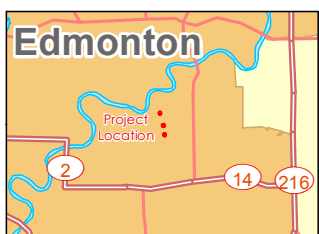

- Project Disturbance Area (PDA)
- Local Assessment Area (LAA)
- Existing Main Trail
- Mill Creek

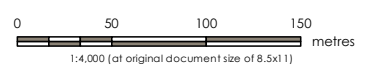

Project Location: SE 28-05-24 W4M, Edmonton, Alberta
 Prepared by MG on 2018-11-14
 Quality Review by DJ on 2019-01-08
 Approved by EL on 2019-01-08

Client/Project: City of Edmonton
 Mill Creek Ravine Park Trail Rehabilitation
 Environmental Review Report

Figure No.: **4**

Title: **Site Location Plan (Site 3)**

- Notes**
1. Coordinate System: NAD 1983 3TM 114
 2. Base features: Geographics, ©Department of Natural Resources Canada. All rights reserved.
 3. Imagery: City of Edmonton, 2017.

Disclaimer: Stantec assumes no responsibility for data supplied in electronic format. The recipient accepts full responsibility for verifying the accuracy and completeness of the data. The recipient releases Stantec, its officers, employees, consultants and agents, from any and all claims arising in any way from the content or provision of the data.

2.0 PROJECT OVERVIEW

The following sections provide a description of alternatives to the Project which were considered for each of the three Sites. Project alternatives were discussed and considered prior to selecting the recommended alternative. The recommended alternative is the Project and is described in the following section (see 2.1 Project Description). Details on construction activities and timing are also provided.

2.1 PROJECT DESCRIPTION

The Project entails rehabilitation of three sections of the existing trail system in Mill Creek Ravine Park (Figures 1 through 4). Construction of the Project is anticipated to begin between fall of 2019 and fall of 2020, pending approvals, and last approximately two to four weeks at each Site following commencement. The COE Granular Walkway specifications as outlined in Drawings LA303 and the Design and Construction Guidelines have been incorporated wherever possible in the Project design (COE 2013; COE 2017e). Where vegetation clearing is required for the Project, the clearing will be kept to a minimum as the alignments have been chosen to minimize disturbance to the existing vegetation.

At Site 1, the existing trail will be realigned further upslope. The proposed trail will include swales along both edges of the trail and the existing trail will be abandoned.

At Site 2, the existing trail will be realigned further upslope. The proposed trail will include a swale on the upslope side and retaining walls further upslope of the swales.

At Site 3, the existing trail will be rehabilitated in place and the east bank of Mill Creek will be armored to prevent further deterioration of the creek bank and trail. A post and rail fence will be installed downslope of the trail for public safety.

The abandoned trails at Site 1 and 2 will be cleared of gravel and will receive topsoil and native plantings (see Appendix 1). All three of the proposed trails will connect to the existing trail system via tie-ins at each end. At each end of the trails, plantings will be added to discourage ongoing use of the abandoned sections of trail by the public. Information signage will also be placed at the end of the abandoned trails for public notice.

2.2 PROJECT ALTERNATIVES

Alternatives for the proposed Project were considered and refined throughout the design phase based on costs, environmental effects, geotechnical constraints, design constraints, safety and limiting disturbance to the NSRV. All alternatives pertaining to Project design are summarized below and are aligned with alternatives presented in the Site Assessment & Design Analysis Report (Stantec 2018a) and the Geotechnical Report (Stantec 2018b). The order in which the alternatives are presented in this report are presented such that the recommended, alternative (the Project) is consistently in the last subsection; and this order may vary from previous reports. These variations are noted in the appropriate subsections. Where alternatives are presented here that are not in the Site Assessment & Design Analysis Report or the Geotechnical Report, these alternatives were developed after the reports were drafted following a site visit conducted by the COE.



2.2.1 Site 1

Two alternatives were considered for Site 1: upgrading an existing unmaintained path located upslope of the existing trail and establishing a new trail which ties into the existing unmaintained path, which are presented as Option 1 and 2, respectively, in the Site Assessment & Design Analysis Report (Stantec 2018a) and Geotechnical Report (Stantec 2018b). Alternative 3 is the proposed Project as presented in this report and is not presented as an Option in the Geotechnical Report. Alternative 3 was adopted as the recommended alternative following a site visit completed by the COE [as per correspondence from Shannon Hall (Project Manager, Open Space Planning and Design)] after the Site Assessment and Design Analysis Report (Stantec 2018a) and the Geotechnical Report (Stantec 2018b) were drafted. While Alternative 3 is not listed as an option in the Geotechnical Report, the hybrid alignment was discussed with a geotechnical professional.

2.2.1.1 Alternative 1: Upgrade to existing unmaintained path

The first alternative considered was the upgrading of an unmaintained path located east of Site 1 (listed as Option 1 in the Site Assessment & Design Analysis Report (Stantec 2018a) and Geotechnical Report (Stantec 2018b)). This upgrading would require removal of a few mature trees, some grading and placement of crushed gravel surfacing material. Generally, grades are steeper in this area than in others (Stantec 2018a).

The environmental effects of this alternative include tree removal, which would be minimal and would maintain the tree canopy. This alternative would require no need for in-stream works.

Sight lines along this trail may lead northbound traffic to an existing informal trail; however, southbound traffic is not likely to be directed along this informal trail because southbound traffic sight lines are focused on the bridge in the distance. Signage and widening the trail intersections may be considered to mitigate this for the southbound traffic (Stantec 2018a; Stantec 2018b). Generally, directing traffic to an existing informal trail is not recommended as use of informal trails causes further ecological deterioration, including damage to native vegetation, increased erosion, spread of weeds and invasive species, and loss of wildlife habitat. The eroding trail section is within relic landslide terrain and unloading of soils from or near the toe of the slope has the potential to reactivate the landslide (Stantec 2018b).

While this alternative requires no new trail construction, it has a high potential for poor sight lines for southbound traffic, and, as determined by the COE, has a high likelihood of leading to the development of a new informal trail within Mill Creek Ravine Park which already has a prevalence of informal trails. Informal trails have negative effects on vegetation community health and may be disturbing to wildlife. Therefore, this alternative is not recommended (Stantec 2018a; Stantec 2018b).

2.2.1.2 Alternative 2: Establish new trail which ties into the existing unmaintained path

The second alternative considered was to connect the unaffected granular trails north of Bridge 277 to the trail system to the south via a new trail by incorporating a section of the existing unmaintained path to the east of the existing trail (listed as Option 2 in the Site Assessment & Design Analysis Report (Stantec 2018a) and Geotechnical Report (Stantec 2018b)). This alternative allows preservation of a logical path routing while reducing the amount of new trail construction needed. Two possible alignments were considered: A and B. Alignment A would include constructing a new trail that extends straight from Bridge 277 to tie-in to the existing unmaintained trail. Alignment B



would include constructing a new trail that extends slightly out from Bridge 277 and then veers south to meet with a more south section of the existing unmaintained trail (see Figure 11 and 12 in Stantec 2018a; Appendix 2).

Alignment A would require less new trail construction than Alignment B. Alignment B would provide more favourable grades and sight lines. Alignments A and B provide adequate setback from the eroding Mill Creek bank, but Alignment B follows more favourable terrain resulting in lower slopes and lower fill volumes to establish the new trail. No in-stream works would be required with either Alignment (Stantec 2018a).

The eroding trail section is within a relic landslide terrain and unloading of soils from or near the toe of the slope has the potential to reactivate the landslide (Stantec 2018b). The geotechnical report considered the construction of a new trail alignment between the eroding trail and the existing unmaintained path and was found this to be geotechnically feasible. While tying a new trail into the existing unmaintained path reduces the amount of new trail construction, it requires earthworks to occur near the toe of the slope where soils conditions are generally fine-grained and sensitive to disturbance. A trail alignment that avoids excavation near the toe of the slope reduces the potential to trigger a landslide (Stantec 2018b); therefore, this alternative is not recommended.

2.2.1.3 Alternative 3 (Recommended): Hybrid alignment incorporating elements of Alternative 1 and 2

The third alternative considered is a hybrid alignment incorporating the elements of Alternatives 1 and 2 as outlined above [this alternative is not presented in the Site Assessment & Design Analysis Report (Stantec 2018a) and Geotechnical Report (Stantec 2018b) as it was developed after the Reports were completed]. Correspondence with Shannon Hall (Project Manager, Open Space Planning and Design) confirmed that representatives of the COE conducted a field visit which concluded that a hybrid alignment is the preferred alternative. The hybrid alignment was chosen as the preferred alternative because it reduces the potential for removal of big trees and reduces potential for development of informal trails. The hybrid alignment will tie-in to the existing trail in the southeast, the same as considered in the two alternatives above, and then will take a more direct path to the bridge. This Project will move forward implementing this hybrid alignment.

2.2.2 Site 2

Three alternatives were considered for Site 2: upgrading the existing unmaintained trail, short radius trail realignment and long radius trail realignment, which are presented in a different order here relative to the Site Assessment & Design Analysis Report (Stantec 2018a) and Geotechnical Report (Stantec 2018b).

2.2.2.1 Alternative 1: Upgrade Existing Unmaintained Trail

The first alternative considered was upgrading an existing unmaintained trail to granular width [listed as Option 3 in the Site Assessment & Design Analysis Report (Stantec 2018a) and Geotechnical Report (Stantec 2018b)]. This trail directs trail users up a slope across the old Whyte Ave roadway right of way, then back down again to tie into the existing trail (see Figure 14 in Stantec 2018a). The north tie-in would have favourable grades, while the south portion of the trail must traverse an old landslide scarp which would require fill placement to achieve an acceptable grade, or the construction of a stairway to provide adequate, safe public access (Stantec 2018a; Stantec 2018b).



Project Overview
May 2019

This alternative requires tree removal, and minor grading work upslope of the trail. This alternative provides significant setback from the actively eroding NSRV wall and can provide a long service life even if a major slope failure occurs. However, due to the challenging grades associated with this alignment, and the need for stairs to be incorporated, this alternative is not recommended.

2.2.2.2 Alternative 2: Short Radius Trail with Retaining Wall

The second alternative considered was an alignment referred to as a short radius curve into the existing trail alignment [listed as Option 1 in the Site Assessment & Design Analysis Report (Stantec 2018a) and Geotechnical Report (Stantec 2018b)]. This alternative would require constructing a short retaining wall in the slope to ensure adequate distance from the NSRV wall. The retaining wall would be approximately 1.5 m high and 8 m long. Tie-in to the existing trail would form a continuous grade of approximately 3% rising to the south (see Figure 12 in Stantec 2018a). This alternative would require excavating into the 5H:1V slope to construct the retaining wall (Stantec 2018b).

This alternative would avoid tree clearing but would require some shrub clearing. There would be no in-stream work required. This alternative would provide a smooth trail profile on reasonable grade.

This alternative was not recommended because it was determined that a greater radius would be a better alternative (see section 2.2.2.3 Alternative 3 (Recommended): Long Radius Trail with Retaining Wall for more details).

2.2.2.3 Alternative 3 (Recommended): Long Radius Trail with Retaining Wall

The third alternative considered was similar to the second but incorporated a longer radius curved alignment [listed as Option 2 in the Site Assessment & Design Analysis Report (Stantec 2018a) and Geotechnical Report (Stantec 2018b)]. This alternative is identified as the recommended alternative in the Geotechnical Report and is also presented as the recommended alternative in this report. This alignment would set the trail back further from the crest of the steep slope to the east. In the case that any future retrogression of the steep slope occurred, a further offset would provide more time before remediation measures are necessary. The retaining wall for this alternative would be approximately 2 m high and 16 m long. Tie-in to the existing trail would form a continuous grade of approximately 3.5% rising to the south (Stantec 2018a; Stantec 2018b).

This alternative would avoid tree clearing but would require some shrub clearing. There would be no in-stream work required.

Due to the balance this alignment provides between stability of the upper slope and amount of space from the proposed trail to the eroding bank, this Project will move forward implementing this alignment.

2.2.3 Site 3

Three alternatives were considered for Site 3: minor trail realignment, major trail realignment and creek bank restoration. Geotechnically, all alternatives for Site 3 were found to be feasible (Stantec 2018b). The alternatives are presented in a different order here relative to the Site Assessment & Design Analysis Report (Stantec 2018a) and Geotechnical Report (Stantec 2018b) and are cross-referenced as such.



2.2.3.1 Alternative 1: Minor trail realignment

The first alternative considered was to realign the granular trail slightly into the floodplain forest [listed as Option 1 in the Site Assessment & Design Analysis Report (Stantec 2018a) and Option 2 in the Geotechnical Report (Stantec 2018b)]. This alternative involves a slight horizontal deflection at the end of Bridge 207 and tying into the existing granular trail beyond the erosion area (Stantec 2018a).

This alternative would require removal of several mature trees, and since the trail traverses the floodplain, vertical grades are relatively flat which will require salvage of fill from the existing trail. The abandoned trail will have to be reclaimed to establish a vegetation buffer between the eroding bank and the new trail. No in-stream works are required for this alternative.

This alternative provides a temporary buffer to the eroding bank, but does not address future erosion concerns which are likely to affect the north tie-in. This alternative was not recommended.

2.2.3.2 Alternative 2: Major trail realignment

The second alternative for Site 3 considered realigning the trail further to the east into the floodplain forest and utilizing some of the existing unmaintained trail in the area [listed as Option 2 in the Site Assessment & Design Analysis Report (Stantec 2018a) and Option 1 in the Geotechnical Report (Stantec 2018b)]. This alternative involves a significant horizontal deflection at the end of Bridge 207. The degree of horizontal deflection in the alignment for this alternative will limit sight lines along the trail. This alternative would also require removal of several mature trees. Because the trail traverses the floodplain, vertical grades are relatively flat which will require salvage of fill from the existing trail. The abandoned trail will have to be reclaimed to establish a vegetation buffer between the eroding bank and the new trail. No in-stream works are required for this alternative (Stantec 2018a; Stantec 2018b).

This alternative incorporates poor sight lines and a larger footprint for mature tree removal compared to the first alternative. It provides a temporary buffer to the eroding bank. This alternative was not recommended.

2.2.3.3 Alternative 3 (Recommended): Rehabilitating the existing trail and creek bank restoration

The third alternative considered involved rehabilitating the existing trail and creek bank restoration [listed as Option 3 in the Site Assessment & Design Analysis Report (Stantec 2018a) and Geotechnical Report (Stantec 2018b)]. There are several methods available including heavy rock riprap armoring, and bioengineering techniques. Since the erosion encroachment into the trail is currently limited to approximately 6 m, bank restoration works may be incorporated into trail reconstruction. A wooden handrail will be incorporated in the design at the edge of the trail to prevent direct access to Mill Creek and provide a safety barrier for cyclists and pedestrians (Stantec 2018a; Stantec 2018b).

This alternative requires in-stream work but salvages the existing granular trail and preserves the trail user experience. A short length of handrail may be required to preserve pedestrian safety adjacent to the top of bank (Stantec 2018b).



MILL CREEK RAVINE PARK TRAIL REHABILITATION, EDMONTON, ALBERTA

Project Overview
May 2019

Due to the spatial constraints of the area (lack of space between the existing trail and the knob), the presence of mature trees immediately adjacent the trail and the interest in preserving sight lines this alternative is recommended. The permanent nature of the activity ensures the long-term integrity of the trail; therefore, the Project will move forward implementing this alternative.

2.3 CONSTRUCTION ACTIVITIES

Construction activities for the Project are described in the sections below.

2.3.1 Access and Site Preparation

Site 1 will be accessed through 95 Street where a laydown area will be located west of Mill Creek in a grassy area on the north side of 95 Street. Site 2 will be accessed from 95A Street where it terminates at the Mill Creek Outdoor Pool. The Site 2 laydown area will be in the northern parking area of the Mill Creek Outdoor Pool. An optional second laydown area is identified in the southern manicured grass area of the Mill Creek Outdoor Pool which will be utilized, if needed. Site 3 will be accessed from the Mill Creek trail system where it initiates at the cul-de-sac at the intersection of 93 St NW and 78 Ave NW. The Site 3 laydown area will be in the grassy manicured area north of the cul-de-sac.

It is anticipated that tracked equipment will be used for construction. Construction access and laydown areas are not anticipated to require any vegetation clearing however, some overhead branch removal may be required to allow taller equipment to access the PDA. Temporary trail closures will be required within the PDAs, and along the access routes during the construction phase. Access and trail closure signs will be located immediately outside of the PDA, and in other locations along the trail system, within the LAA to ensure that trail users have adequate notice.

Site preparation will include closing the existing trail, installing Erosion and Sediment Control (ESC) measures, installing information signage regarding trail closures and construction activities. Detours will not be put in place during the construction phase of the Project because of the lack of safe detour within the LAA. Following construction all access routes and laydown areas will be remediated according to existing site conditions.

2.3.2 Construction Components

The following sections contain descriptions of the construction activities required to complete the Project. The construction activities are anticipated to remain within the PDA of each Site.

2.3.2.1 ESC Measures

The erosion risk at the Project location is relatively low. At Site 1, there is an existing, well vegetated area between the proposed trail and Mill Creek, whereas at Site 2, there is less of an existing vegetated area. However, all temporary ESC measures, such as silt fences, will be installed and will remain in place until vegetation has established on both the existing trails and along the proposed trails at Sites 1 and 2. At Site 3, the required in-stream works will be isolated and ESC measures will be implemented to reduce the effect of the in-stream works on the water quality of Mill Creek. Similar interim ESC measures may be implemented at Site 3, as needed and determined by the contractor. The contractor will be responsible for developing an ESC plan outlining erosion mitigation measures for the construction areas (laydown, staging, etc.), and the existing trail. The contractor will also regularly



assess the need for interim ESC measures by factors such as amount of bare ground exposed, topography and forecasted weather.

2.3.2.2 Vegetation Clearing

Vegetation clearing will be limited to only what is required for the proposed trail's footprint within the PDAs of Sites 1 and 2. Site 1 will require approximately 224 m² and Site 2 will require approximately 152 m² of vegetation clearing; totaling approximately 376 m². Site 3 is not anticipated to require vegetation clearing. However, the access route to Site 3 may require some branches to be cleared overhead along the access route to allow for safe passage of equipment. At Site 3, the restoration of the existing trail will require bringing materials into the PDA to fill and construct the trail such that it mimics the non-damaged sections of the trail.

2.3.2.3 Bank Armouring and Post and Rail Fence Installation

The east bank of Mill Creek will be armoured at Site 3. Some fill work will be required at Site 3 where the trail has been eroded by Mill Creek. The bank armouring will consist of laying down of a geotextile fabric which will be overlain by heavy rock and rip rap. Upslope of this area, 150 mm of topsoil, and live willow plantings will be added. A post and rail fence will be installed between the bank restoration area and the trail. Details of the bank armouring and the post and rail fence are in Appendix 1.

2.3.2.4 Trails and Granular Swales

At Sites 1 and 2, the trails will be developed as shown in Appendix 1. The proposed trails will be 2 m in width and incorporate granular swales. The trails at Sites 1 and 2 will be constructed using 150 mm 3-20A crushed gravel laid on top of a 150 mm compacted subgrade. Approximately 150 mm of topsoil will be removed and stockpiled for re-use during re-vegetation.

2.3.2.5 Retaining Walls

Retaining walls will be installed at Site 2 adjacent to the proposed trail (see Appendix 1). Installation of the retaining walls will require cutting into the knob upslope of the proposed trail and grading the area. Materials excavated from these activities will be hauled offsite immediately during the construction phase.

2.3.2.6 Abandonment of Existing Trails

The existing trail sections will be remediated with 150 mm of topsoil and will receive plantings of willow whips. Prickly roses will be planted at either end of the existing trails (Sites 1 and 2) to discourage trail users from entering these sections of the trail system. ESC measures will be installed and left in place until vegetation has established.

2.3.3 Rehabilitation

The cleared areas within the PDAs for Site 1 and Site 2 will receive native stockpiled topsoil and naturalized seed mix. The existing trails will receive plantings of prickly rose, or other species to deter future use by trail users. Information signage will be installed at both accesses of the existing trail.



MILL CREEK RAVINE PARK TRAIL REHABILITATION, EDMONTON, ALBERTA

Project Overview

May 2019

Following construction, the laydown area may need to be rehabilitated due to soil compaction resulting from construction activity. This, and any other type of rehabilitation work that may be required due to construction activities will be completed following construction.

2.3.4 Operations and Maintenance

Maintenance of the proposed trail will follow standard operation procedures for gravel trails in the NSRV as determined by the COE.



3.0 REGULATORY CONSIDERATIONS

Various federal, provincial and municipal acts, regulations or bylaws may need to be considered for the Project. Regulatory consideration may be required for the items listed in Table 3-1 below.

Table 3-1 Regulatory Considerations

Name of Regulatory Consideration	Federal, Provincial or Municipal
<i>Migratory Birds Convention Act, 1994</i>	Federal
Migratory Birds Regulations, C.R.C., c.1035.	Federal
<i>Species At Risk Act (SARA), 2002</i>	Federal
<i>Environmental Protection and Enhancement Act, 2000</i>	Provincial
<i>Historical Resources Act, 2000</i>	Provincial
<i>Weed Control Act, 2008</i>	Provincial
Weed Control Regulation, 2010	Provincial
<i>Wildlife Act, 2000</i>	Provincial
<i>City of Edmonton North Saskatchewan River Valley Area Redevelopment Plan (Bylaw 7188) (COE 2017d)</i>	Municipal
<i>City of Edmonton Community Standards Bylaw (Bylaw 14600) (COE 2017c)</i>	Municipal
<i>City of Edmonton Corporate Tree Management Policy C456A (COE 2010a)</i>	Municipal
<i>Ribbon of Green Concept Plan (COE 1990)</i>	Municipal
<i>Ribbon of Green Master Plan (COE 1992)</i>	Municipal
<i>The Way We Grow, Municipal Development Plan (COE 2010b)</i>	Municipal
<i>The Way Ahead (Edmonton’s Strategic Plan) (COE 2014)</i>	Municipal
<i>The Way We Green, City of Edmonton Environmental Strategic Plan (COE 2011)</i>	Municipal
<i>The Way We Live, Edmonton’s People Plan (COE 2010c)</i>	Municipal



4.0 EXISTING CONDITIONS

The following sections summarize the results of the desktop review and provide an understanding of the existing baseline conditions in the LAAs.

4.1 DESKTOP REVIEW

The Project exists in a forested area (Sites 1 and 2), and at the east bank of Mill Creek (Site 3). Relevant information pertaining to the hydrology, geology and soils, vegetation, wildlife, fish and fish habitat, and socio-economic environment was reviewed and summarized as part of the desktop review. Information sources that were reviewed included reference material and other literature, internet sites, and online databases:

- *Mill Creek Ravine Trail Rehabilitation – Geotechnical Report* (Stantec 2018b)
- *Condominium Development, Whyte Avenue and 93rd Street, Edmonton, Alberta, Top of Bank Set Back Assessment* (Thurber 2005)
- *Mill Creek Erosion Study* (AE 2016a)
- *Mill Creek Ravine Early and Late Season Rare Plant Survey* (AE 2016b)
- AGS Map 600 - Bedrock geology of Alberta (Prior *et al.* 2013)
- Surficial Geology of the Edmonton District, Alberta (Bayrock and Hughes 1962)
- Geology of the City of Edmonton; Part 1: Central Edmonton (Bayrock and Berg 1966)
- Urban Geology of Edmonton, Alberta Research Council Bulletin 32. (Kathol and McPherson, 1975)
- Floodplain Protection Overlay Map. City of Edmonton Zoning Bylaw 12800, Section 812 (COE 2008a)
- *Flood Plain Study of the North Saskatchewan River through Edmonton* (Alberta Environment 1974)
- Flood Hazard Map Application (AEP 2012)
- North Saskatchewan Watershed Alliance (NSWA 2005; NSWA 2012)
- Natural regions and subregions of Alberta (NRC 2006)
- Biodiversity Report (COE 2008b)
- North Saskatchewan River valley and ravine system biophysical study (EPEC Consulting Western Ltd. 1981)
- *A preliminary vegetation and wildlife analysis of the Edmonton – Fort Saskatchewan restricted development area* (Strong and MacCallum 1984)
- *A biophysical inventory and analysis of the Fort Saskatchewan and Devon restricted development area* (Strong *et al.* 1985)
- Fish and Wildlife Management Information System (FWMIS) database (AEP 2016)
- Alberta Conservation Information Management System (ACIMS) database (ACIMS 2015)

The following sections summarize the database searches that were conducted and are organized by each VC.



4.2 HYDROLOGY

The PDAs are not located within the predicted 1:100 year flood level (COE 2008a). The PDAs generally consist of level topography with some steep slopes. Surface water within the LAAs flows north, eventually draining into the NSR.

The North Saskatchewan Watershed (NSW) extends from the Columbia Ice Fields in Banff National Park east to the Alberta/Saskatchewan border, draining approximately 80,000 square km (NSWA 2005). The three Sites are within the Beaverhill Sub-watershed Unit, which is subject to considerable urban and industrial developments including: oil and gas, agriculture, housing and chemical manufacturing. Other anthropogenic activity in this watershed includes recreational activities such as bird watching, hiking, canoeing, cross-country skiing, snowmobiling and horseback riding (NSWA 2005).

Sections of the NSR are designated as Class A. Mill Creek flows into a section of the NSR which is designated a Class C waterbody. Within the LAAs, Mill Creek is mapped as a Class D waterbody with no restricted activity periods (AEP 2012).

4.3 GEOLOGY AND SOILS

Bedrock in the LAAs belong to the Upper Cretaceous Horseshoe Canyon Formation and is composed of pale grey, fine to very fine grained, feldspathic sandstone interbedded with siltstone, bentinitic mudstone, carbonaceous mudstone, concretionary sideritic layers and laterally continuous coal seams (Prior et al. 2013). Surficial geology units in the LAAs mainly consist of alluvial deposits along river terraces including alluvial gravel, sand, and silt (Bayrock and Hughes 1962; Bayrock and Berg 1966). The soils in the LAAs are classified as Chernozemic, malmo silt loam described as eluviated black developed on lacustrine material (Kathol and McPherson 1975). These LAAs are within an area containing Erosional Features, including gully, creek valley, or scarp with thin colluvial cover on valley slopes, thin alluvial materials along streams and mixed glacial and bedrock material in slump areas (Kathol and McPherson 1975).

In a top of bank set back assessment (Thurber 2005), for a condominium located at the crest of the Ravine at Site 2, a steep eroded bank was noted, which at that time was identified as having the potential to affect the trail at some point in the future (Thurber 2005). A previously conducted erosion study, found that Mill Creek is actively down cutting the ravine which is leading to slumping and increased erosion. It was also found that surface runoff down the valley slopes is also contributing to the instability (AE 2016a). Within the PDAs at each of the Sites, Mill Creek undercuts the outer bank resulting in erosion and stability issues (Stantec 2018b). There are several large-scale relic landslide scarps along the valley walls and ravine escarpment. This risk was perceived to be greater at Site 2, and the results of a detailed terrain assessment were incorporated into the design of the Project (Stantec 2018b).

4.4 VEGETATION

The three Sites are situated within the Central Parkland Natural Subregion (Central Parkland), which is located within the Parkland Natural Region (NRC 2006). This Subregion is a large transition zone between the Boreal Forest Natural Region to the north and the Grassland Natural Region to the south. The Central Parkland is dominated by



MILL CREEK RAVINE PARK TRAIL REHABILITATION, EDMONTON, ALBERTA

Existing Conditions
May 2019

undulating till plains and hummocky uplands. Under natural conditions, native vegetation community remnants are a mosaic of aspen (*Populus tremuloides*) dominated forest stands on moist sites intermixed with prairie vegetation on drier sites. Stands of aspen dominated forest are found throughout the Central Parkland and have understories dominated by saskatoon (*Amelanchier alnifolia*), prickly rose (*Rosa acicularis*), and beaked hazelnut (*Corylus cornuta*). Stands dominated by balsam poplar (*Populus balsamifera*) occur on moist, nutrient rich sites, and often have aspen and white spruce (*Picea glauca*) intermixed within the stand (NRC 2006).

The Mill Creek Ravine Park extends southeast from the NSRV which is a Biodiversity Core Area (COE 2008b). Biodiversity Core Areas may provide the habitat types necessary for rare plants/plant communities.

4.4.1 Desktop Review

This desktop review was completed by searching the ACIMS database and by referring to a rare plant survey completed by Associated Engineering (AE 2016b).

4.4.1.1 ACIMS

A review of the ACIMS GIS layers within 1 km of the Project footprints returned one historical observation of tracked species (see Table 4-1):

Table 4-1 Summary of ACIMS Database Search Results

Species ¹		ACIMS Ranking ²	Observation Date ¹	Location (10TM) ¹
<i>Rhodobryum ontariense</i>	Ontario rhodobryum moss	S1S2	1974-10-02	600955.57, 5929308.36
Notes:				
¹ ACIMS (2015).				
² Rare species are those that are listed as:				
<ul style="list-style-type: none"> • Threatened or Endangered under the provincial <i>Wildlife Act</i>. R.S.A. 2000, c. W-10 • Sensitive, May Be At Risk, or At Risk under the General Status of Alberta Wild Species • S1, S2, or S3 by the ACIMS (2017a) 				

4.4.1.2 Rare Plant Survey

In 2016, a rare plant survey was completed for the three Sites. The study areas described in the report were determined according to the habitat type they are located in. Based on the results of the rare plant survey, the LAAs are characterized as a natural deciduous forest, with a forest-mowed lawn interface present at Site 2. Generally, there were no vascular plant species observed within Mill Creek and limited algae was observed. A complete species list is included in Appendix 2 of the rare plant survey report (AE 2016b, Appendix 3).



MILL CREEK RAVINE PARK TRAIL REHABILITATION, EDMONTON, ALBERTA

Existing Conditions
May 2019

In July 2016, smooth sweet cicely (*Osmorhiza longistylis*) was found in two locations at Site 2 (34930 m E, 5931858 m N; and 34961 m E, 5931866 m N) and in one location at Site 3 (35048 m E, 591259 m N). During the August visit, Ontario rhodobryum moss (*Rhodobryum ontariense*) was found in one location at Site 3 (35032, 5911263) (AE 2016b). GPS coordinates of the observations are listed in 3TM 114 coordinate system.

Weed Species

Although a weed survey was not completed, five species designated as *noxious* in the *Weed Control Regulation* (Alta. Reg. 19/2010) were observed within the LAAs (AE 2016). Canada thistle (*Cirsium arvense*) and perennial sow thistle (*Sonchus arvensis*) were observed at each site. White cockle (*Lychnis alba*) was observed at Site 2. Common tansy (*Tanacetum vulgare*) was observed at Site 1 and Site 3. Scentless chamomile (*Anthemis arvensis*) was observed at Site 1.

Plant Communities

The three Sites are located within the Central Parkland Natural Subregion along Mill Creek. The dominant vegetation community is mixed deciduous forest of the *Populus tremuloides* – *Populus balsamifera* forest/woodland alliance (Wheatley and Bentz 2002). The vegetation communities observed for the three Sites surveyed during the rare plant surveys are described below.

Site 1

Site 1 contained two different plant communities, one forested and one riparian. Deciduous tree species dominated the canopy of the forested plant community including, balsam poplar (*Populus balsamifera*), bur oak (*Quercus macrocarpa*), Manitoba maple (*Acer negundo*), trembling aspen (*Populus tremuloides*), western mountain-ash (*Sorbus scopulina*), and white spruce (*Picea glauca*). The shrub layer includes beaked hazelnut (*Corylus cornuta*), chokecherry (*Prunus virginiana*), common blueberry (*Vaccinium myrtilloides*), low-bush cranberry (*Viburnum edule*), northern gooseberry (*Ribes oxycanthoides*), prickly rose (*Rosa acicularis*), red-osier dogwood (*Cornus sericea ssp. sericea*), Saskatoon (*Amelanchier alnifolia*), snowberry (*Symphoricarpos albus*), wild red currant (*Ribes triste*), and wild red raspberry (*Rubus idaeus*); and the invasive common buckthorn (*Rhamnus cathartica*). The herbaceous layer included non-native graminoid species such as smooth brome (*Bromus inermis*), timothy (*Phleum pratense*), and quackgrass (*Elymus repens*); native graminoid species Kentucky bluegrass (*Poa pratensis*); non-native forbs such as Canada thistle (*Cirsium arvense*), common burdock (*Arctium minus*), common tansy (*Tanacetum vulgare*), perennial sow-thistle (*Sonchus arvensis*), and scentless chamomile (*Tripleurospermum inodorum*); and, native forbs such as palmate-leaved coltsfoot (*Petasites frigidus var. palmatus*), wild lily-of-the-valley (*Maianthemum canadense*), and wild sarsaparilla (*Aralia nudicaulis*).

A riparian plant community was observed along the banks of Mill Creek. Some of the species observed included nodding beggarticks (*Bidens cernua*), common cattail (*Typha latifolia*), common horsetail (*Equisetum arvense*), and stinging nettle (*Urtica dioica*). There were no vascular plant species observed within the Mill Creek.

Site 2

A forested plant community characterized Site 2 dominated by mixed deciduous tree species. The canopy species were the same as Site 1 and included balsam poplar, bur oak, Manitoba maple, trembling aspen, western mountain-



MILL CREEK RAVINE PARK TRAIL REHABILITATION, EDMONTON, ALBERTA

Existing Conditions
May 2019

ash, and white spruce. The shrub layer included beaked hazelnut, Canada buffaloberry (*Shepherdia canadensis*), chokecherry, common blueberry, low-bush cranberry, northern black currant (*Ribes hudsonianum*), northern gooseberry, pin cherry (*Prunus pensylvanica*), prickly rose, red-osier dogwood, Saskatoon, snowberry, wild red currant, and wild red raspberry as well as the invasive caragana (*Caragana arborescens*) and common buckthorn. The herbaceous layer at Site 2 included the two patches of the rare forb species smooth sweet cicely (*Osmorhiza longistylis*) ranked S3; non-native graminoid species such as smooth brome and redtop (*Agrostis stolonifera*); non-native forbs including Canada thistle, common burdock, common toadflax (*Linaria vulgaris*), perennial sow-thistle, and white cockle (*Silene latifolia*); and, native forbs including common fireweed (*Chamerion angustifolium*), snakeroot (*Sanicula marilandica*), spreading dogbane (*Apocynum androsaemifolium*), and western Canada violet (*Viola canadensis*).

Site 3

Site 3 contained two different plant communities, one forested and one riparian. A mix of deciduous tree species dominated the forested plant community. The canopy species included balsam poplar, bur oak, Manitoba maple, trembling aspen, western mountain-ash, and white spruce. The shrub layer included beaked hazelnut, Canada buffaloberry, chokecherry, common blueberry, low-bush cranberry, northern black currant, northern gooseberry, prickly rose, red elderberry (*Sambucus racemosa*), red-osier dogwood, Saskatoon, shining willow (*Salix lasiandra* var. *lasiandra*), silverberry (*Elaeagnus commutata*), snowberry, wild red currant, and wild red raspberry as well as the invasive caragana and common buckthorn. The herbaceous layer at Site 3 included one patch of the rare species smooth sweet cicely ranked S3 and one patch of the rare Ontario rhodobryum moss (*Rhodobryum ontariense*) ranked S1S2. In addition, the herbaceous layer included non-native graminoid species smooth brome; non-native forbs including Canada thistle, common burdock, common tansy, perennial sow-thistle; and, native forbs including bunchberry (*Conus canadensis*), common pink wintergreen (*Pyrola asarifolia*), dewberry (*Rubus pubescens*), fairybells (*Prosartes trachycarpa*), greenish-flowered wintergreen (*Pyrola chlorantha*), Labrador lousewort (*Pedicularis labradorica*), narrow-leaved hawkweed (*Hieracium umbellatum*), and sweet-scented bedstraw (*Galium triflorum*),

A riparian plant community was observed along the banks of Mill Creek. Some of the species observed included nodding beggarticks, common horsetail, Peck's sedge (*Carex peckii*), and Sprengel's sedge (*Carex sprengelii*). There were no vascular plant species observed within the creek.

4.5 WILDLIFE

The following sections discuss the results of the desktop review for wildlife in the LAAs.

The LAAs are upslope of Mill Creek which is a tributary to the NSR. Wildlife inventories have suggested that tributaries of the NSRV support a large diversity of species because of the availability of a wide range of habitats (e.g., EPEC 1981, Strong and MacCallum 1984, Strong et al. 1985). The mixed deciduous and evergreen woodland alliance provides foraging, breeding and shelter habitat for wildlife species common to the COE.

The COE (2008b) lists 225 species that may occur within the LAAs. These include 178 species of birds, 47 mammals, and seven herptiles. Many of these species are considered species of management concern.



MILL CREEK RAVINE PARK TRAIL REHABILITATION, EDMONTON, ALBERTA

Existing Conditions
May 2019

The LAAs include manicured parkland along access routes and the trail itself is within a deciduous woodland alliance community along Mill Creek. The deciduous woodland alliance community has the potential to support a diversity of wildlife species including amphibians and reptiles, birds and mammals.

4.5.1 FWMIS

A FWMIS database search was completed in February 2018 to obtain information on species of management concern and wildlife sensitivity layers occurring within two km of the PDAs. A minimum of one km radius was used to capture species with large home ranges (e.g., ungulates, raptors) that have been observed in adjacent area and whose ranges may overlap with the PDA. Species of management concern were summarized and referenced to provincial and federal ranking.

The FWMIS results revealed the occurrence of one bird species of management concern (AEP 2017). The LAAs are located within sensitive bird sharp-tailed grouse and bald eagle range (AEP 2017). See Table 4-2 for details on these species, and their provincial and federal listing.

Table 4-2 Species of Management Concern Present within a 1 km Radius of the LAAs

Species			Conservation Status		
Family	Scientific Name	Common Name	COSEWIC ¹	Alberta Wild Species Rank ²	SARA ¹
<i>Strigidae</i>	<i>Asio flammeus</i>	Short-eared owl	<i>Special concern</i>	<i>May Be at Risk</i>	<i>Special concern</i>
NOTES: ¹ AEP. 2018a. Species at Risk Public Registry. ² AEP. 2018b. Wild Species Status Search.					

Species of management concern identified through the FWMIS database search are discussed below.

4.5.2 COE City Wide Environmental Sensitivity Analysis

The LAA was compared to environmental sensitivity GIS layers associated with the COE: City Wide Environmental Sensitivity Analysis (Solstice 2017; Figure 5).

The Environmental Sensitivity Analysis GIS layer incorporates and assesses mapped assets, threats and development constraints and assigns a single score. Assets include terrestrial and aquatic habitats; naturalized stormwater management facilities; rare or unique species, vegetation communities, landforms, or microclimates; connective habitats and protected lands. Threats include intensive land use, outfalls and stormwater ponds. Development constraints include floodway/floodplains, steep sloped and cultural resources. The assigned single score is then categorized as a qualitative value of environmental sensitivity where extremely high values are given to areas with the highest assets and the highest development constraints and lowest values are given to areas with the lowest assets and lowest development constraints. The LAA was found to intersect with extremely high, very high, high, moderate and low value environmental sensitivity areas, while the PDA intersects with extremely high and very high value environmental sensitivity areas.



MILL CREEK RAVINE PARK TRAIL REHABILITATION, EDMONTON, ALBERTA

Existing Conditions
May 2019

Lower value assets within corridors are sites that lie within identified arboreal and terrestrial corridors. These areas have been narrowed by some form of adjacent development, or are habitats separated by a gap that if enhanced could improve connectivity within wildlife corridors. Low moderate assets in corridors were identified in the upslope portions of the LAA within the residential and manicured grass areas close to the edges of the LAA boundary.

Low and moderate land use threat areas require restoration efforts aimed at reducing the effect of low land use threats immediately adjacent to higher sensitivity sites and provide a better buffer to those sites from human activity. Within the LAAs of all three Sites, these threat areas were identified near the edges of the LAAs. These threat areas were mainly located in the residential areas that are near the edge of the LAAs, as well as the manicured grass area east of Site 1. These areas did not intersect with, and were located upslope and well away from, the PDAs.

The LAA was also compared to summer terrestrial, and arboreal pinch points layers and was found to not intersect with these areas (Solstice 2017). However, a very small area (approximately 0.016 ha) of coyote winter terrestrial pinch point was identified near the southwest edge of the Site 3 LAA.



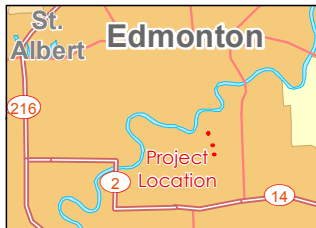
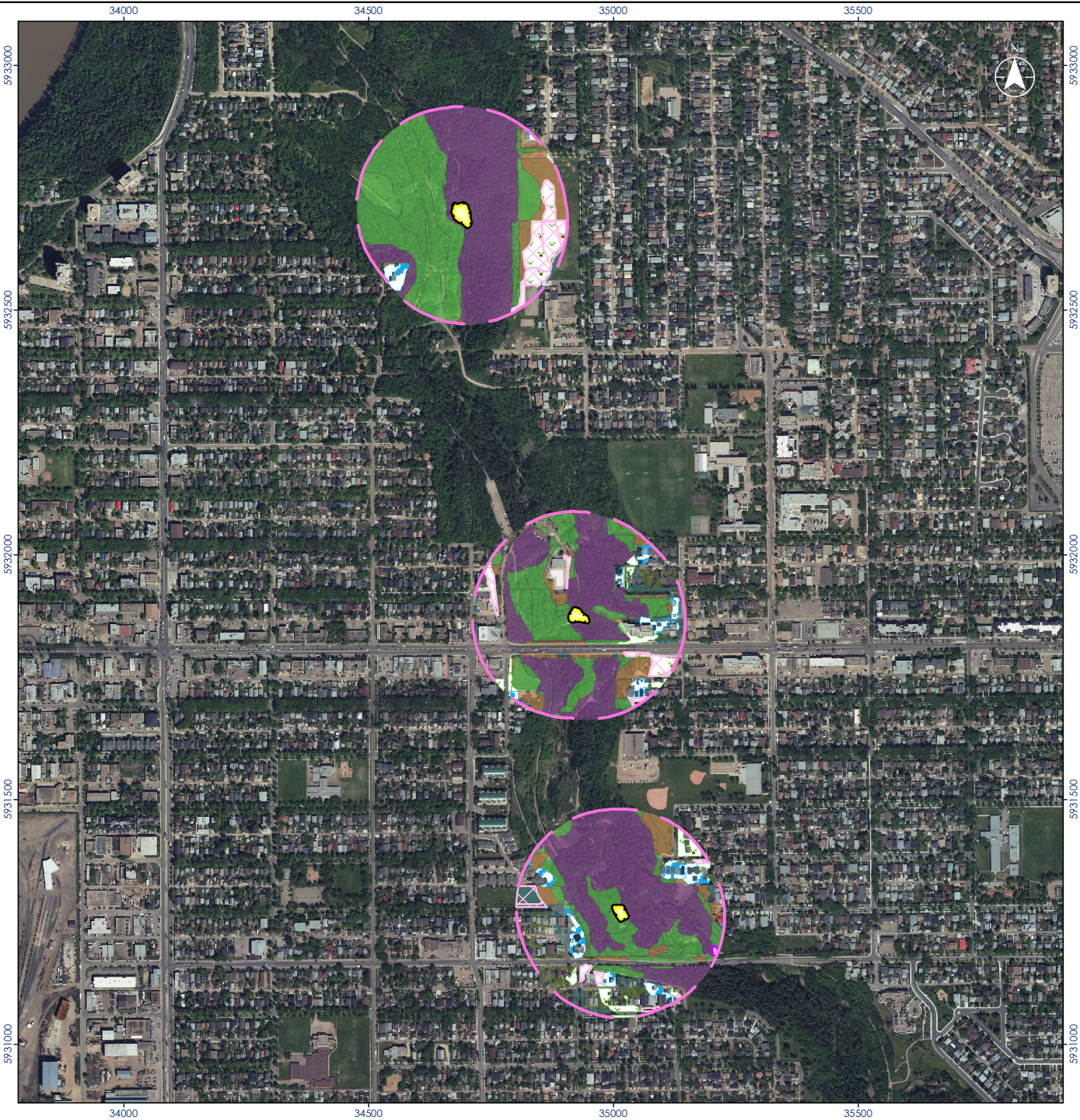

- Notes**
1. Coordinate System: NAD 1983 3TM 114
 2. Base features: GeoGIS, ©Department of Natural Resources Canada. All rights reserved.
 3. Imagery: City of Edmonton, 2017.

Disclaimer: Stantec assumes no responsibility for data supplied in electronic format. The recipient accepts full responsibility for verifying the accuracy and completeness of the data. The recipient releases Stantec, its officers, employees, consultants and agents, from any and all claims arising in any way from the content or provision of the data.

- Project Disturbance Area (PDA)
- Local Assessment Area (LAA)
- Environmental Sensitivities***
- Extremely High Value
- Very High Value
- High Value
- Moderate Value
- Low Value
- Land Use Threats Low Near High Plus Assets (21)
- Land Use Threats Moderate Near High Plus Assets
- Low Moderate Assets in Corridors
- Coyote Winter Pinchpoints

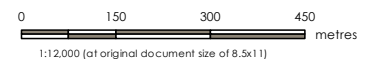

Project Location: Edmonton, AB 123313408
 Prepared by MG on 2018-11-14
 Quality Review by DJ on 2019-01-08
 Approved by EL on 2019-01-08

Client/Project: City of Edmonton
 Mill Creek Ravine Park Trail Rehabilitation
 Environmental Review Report

Figure No. **5**

Title: **Environmental Sensitivities**

*Environmental Sensitivities data provided by Solstice (2017).

Existing Conditions
May 2019

4.6 FISH AND FISH HABITAT

Historical fish capture data within the NSR were compiled and reviewed using AEP's online FWMIS database (AEP 2017). The FWMIS search for fish species was conducted on February 14, 2018 and included 3 km upstream and 3 km downstream from Site 3. The FWMIS search identified three fish species within the search area that were not listed as species of management concern under SARA, COSEWIC (AEP 2018a), or the Alberta list of Species at Risk (AEP 2018b).

4.7 SOCIO-ECONOMIC ENVIRONMENT

The following sections discuss the results of the socio-economic environment desktop review.

4.7.1 Historical Imagery Review

A review of the available imagery indicated that vegetation and land use within the LAA has remained unchanged since the earliest imagery reviewed (2002). Over this period, both the treed portion along Mill Creek Ravine, the walking trails, and the manicured grass within the LAAs have remained unchanged over the course of the photos reviewed.

4.7.2 Land Use

The LAAs are mainly within Metropolitan Recreation Zone (i.e., A) owned by the COE (COE 2017a; COE 2017b). A portion of Site 1 is within a Public Parks Zone (i.e., AP) and an Urban Services Zone (i.e., US) to the east. Portions of Sites 2 and 3 are within a mix of residential, business/commercial, direct control zones, and some portions of Urban Services Zone. Generally, the three Sites are located within the NSRV which is often used for recreational purposes year-round.

4.7.3 Coal Mines

A review of the Alberta Energy Regulator Coal Mine Map Viewer identified that the Project does not intersect any known coal mines (Alberta Energy Regulator 2018).

4.7.4 Archaeological and Historical Resources

A search of the Historical Resources Management Branch GIS layer indicated the LAAs intersect areas of historical resource value (HRV). HRVs intersected by the LAAs include HRV 5 (a,h,p) which designates an area with a high potential for containing archaeological and paleontological historic resources, and HRV 2 (h) which designates an area designated under the *Historical Resources Act* as a Municipal or Registered Historic Resource.

At the time this report was written, an *Historical Resources Act* Clearance application for the LAAs had been submitted to Alberta Culture and Tourism (ACT).



5.0 ASSESSMENT METHODS

The following sections describe the methods used to determine potential Project interactions, and to characterize the existing environmental features and conditions. All construction activities associated with the Project are anticipated to occur in previously undisturbed forested area. A field assessment was not conducted for the Project and the following assessment is based on a review of historic air photos and a desktop review of available environmental information. The potential Project interactions were used to define which VCs will be assessed.

5.1 VALUED COMPONENTS AND POTENTIAL PROJECT INTERACTIONS

VCs are defined as “environmental features that may be affected by a project and that have been identified to be of concern by the City, government agencies, Aboriginal peoples, or the public. The value of a component not only relates to its role in the ecosystem, but also to the value people place on it.” (CEAA 2012). VCs for the Project were selected with the objective of scoping the effects assessment to Project interactions that are of interest to the regulatory authority, the public, and the scientific community. The selection criteria for VCs include consideration of legislative or policy drivers, presence in the Project vicinity, and likelihood of interactions with the Project.

The eight VCs that may be affected by the Project have been identified as:

- Hydrology and water quality
- Geology and soils (and geomorphology)
- Vegetation
- Wildlife
- Fish and fish habitat
- Noise
- Aesthetics
- Archaeological and historical resources

Odor was not included as a VC in the assessment because the Project is not expected to cause odor concerns.

Potential Project interactions with the VCs are identified in Table 5-1 to scope the assessment.



Table 5-1 Potential Interactions between the Project Activities and Valued Components

Construction Activities	Description	Valued components						
		Hydrology and Water Quality	Geology and Soils (and Geomorphology)	Vegetation	Wildlife and Fish and Fish Habitat	Noise	Aesthetics	Archaeological and Historical Resources
Site preparation	<ul style="list-style-type: none"> Establishing laydown areas Staking and delineating PDAs 	✓		✓	✓	✓	✓	
Vegetation clearing and striping of topsoil	<ul style="list-style-type: none"> Removal of trees (Site 1) and shrubs (Site 2) Striping of topsoil (All Sites) 	✓	✓	✓	✓	✓	✓	✓
Construction Components	<ul style="list-style-type: none"> ESC measures (All Sites) Trail construction (Sites 1 and 2) Trail rehabilitation (Site 3) Granular swale construction (Sites 1 and 2) Retaining wall construction (Site 2) Bank armoring (Site 3) Post and rail fence installation (Site 3) 	✓	✓		✓	✓	✓	✓
Excavation, grading and fill	<ul style="list-style-type: none"> Excavation (Sites 2 and 3) Grading (All Sites) Fill (Site 3) 	✓	✓	✓	✓	✓	✓	✓
Rehabilitation	<ul style="list-style-type: none"> Replace stockpiled topsoil (All Sites) De-compaction of laydown areas (All Sites) Seeding native vegetation, placing sod and/or planting proposed trees within PDAs (All Sites) 	✓	✓	✓	✓	✓	✓	
Operation and maintenance	<ul style="list-style-type: none"> Snow removal Tree pruning Ground maintenance 	✓	✓	✓	✓	✓	✓	
Note: "✓" = Potential interactions that might cause an effect.								

Baseline conditions were evaluated through desktop review presented in Section 5.0.

5.2 RESIDUAL ENVIRONMENTAL EFFECTS ASSESSMENT

The residual effects of the Project are characterized based on magnitude, spatial extent, duration, and likelihood of occurrence (Noble 2006). Definitions of magnitude, spatial extent, duration, and likelihood summarized from Noble (2006) are described below. Section 6.0 includes the assessment of environmental effects on the VCs identified



MILL CREEK RAVINE PARK TRAIL REHABILITATION, EDMONTON, ALBERTA

Assessment Methods
May 2019

previously in section 4.1. Potential effects are described, followed by mitigations, and residual effects. Criteria used to assess potential residual effects on the VCs are provided in Table 5-2.

Table 5-2 Residual Effect Characterization Definitions

Parameter		Definition
Direction		<p>Positive – a residual effect that moves the parameters in a direction beneficial to the VC relative to baseline</p> <p>Adverse – a residual effect that moves the parameters in a direction detrimental to the VC relative to baseline</p> <p>Neutral – no net change in the parameters for the VC's relative to baseline</p>
Magnitude*	<i>Hydrology and water quality</i>	<p>Low – minimal to no alternation of surface water flow patterns, water volume, or water quality</p> <p>Moderate – a measurable alteration of water volume and/or partial decrease in water quality that is not expected to adversely affect the creek hydrology or exceed applicable water quality guidelines</p> <p>High – a measurable alteration of water volume and/or decrease in water quality that will alter the hydrology of the creek (e.g. cause downstream erosion) and/or result in exceedances in applicable water quality guidelines</p>
	<i>Geology, soils and geomorphology</i>	<p>Low – no measurable adverse change in soil quality, and/or in slope stability resulting from construction activities</p> <p>Moderate – a measurable change in soil quality and quantity which is unlikely to adversely affect the vegetation communities within the PDA, and/or introduction of a risk to slope stability that may cause slope failure over the long term if not addressed</p> <p>High – a measurable change in soil quality and quantity resulting in a change in soil quality that will adversely affect the success of the Project, and/or introduction of risk to slope stability that may cause slope failure in the short term</p>
	<i>Vegetation</i>	<p>Low – distribution and abundance of native plant communities or trees are not reduced (or increased for a positive magnitude) in the LAAs</p> <p>Moderate – distribution and abundance of native plant communities or trees are reduced but not lost in the LAAs (or, for a positive magnitude, are only slightly increased such that they do not significantly change native plant community composition)</p> <p>High – distribution and abundance of native plant communities or trees are completely removed from the LAAs during construction activities (or, for a positive magnitude, are increased such that there is a significant change to native plant community composition)</p>
	<i>Wildlife</i>	<p>Low – no change to wildlife mortality risk, wildlife habitat or wildlife movements during construction activities</p> <p>Moderate – a change to wildlife mortality risk, wildlife habitat or wildlife movements during construction activities which leads to no loss of species diversity or movement corridors</p> <p>High – a change to wildlife mortality risk, wildlife habitat or wildlife movements such that species diversity is decreased by some degree, wildlife connectivity is lost permanently, and wildlife mortality occurs during the construction phase and may continue through the operational phase</p>



MILL CREEK RAVINE PARK TRAIL REHABILITATION, EDMONTON, ALBERTA

Assessment Methods
 May 2019

Parameter		Definition
Magnitude*	<i>Fish and Fish Habitat</i>	<p>Low – no change to fish mortality risk, fish habitat, or sediment concentrations during construction activities</p> <p>Moderate – a change to fish mortality risk, fish habitat, or sediment concentrations during construction activities which leads to no loss of species diversity or spawning and rearing habitats</p> <p>High – a change to fish mortality risk, fish habitat, or sediment concentrations such that species diversity is decreased by some degree, spawning and rearing habitats are damaged or lost, and fish mortality occurs during the construction phase and may continue through the operational phase</p>
	<i>Noise</i>	<p>Low – no change to baseline acoustic setting</p> <p>Moderate – a change above baseline variation but less than City guidelines during construction activities</p> <p>High – change to baseline acoustic setting, that exceed City guidelines during construction activities</p>
	<i>Aesthetics</i>	<p>Low – no change to key elements/features/characteristics such that the PDA is uncharacteristic relative to the rest of the LAAs</p> <p>Moderate – a change to key elements/features/characteristics such the PDAs may be somewhat uncharacteristic relative to the rest of the LAAs</p> <p>High – a total loss or alteration to key elements/features/characteristics such that the PDAs become totally uncharacteristic relative to the rest of the LAAs</p>
	<i>Archaeological and historic resources</i>	<p>Low - no loss of archaeological and historic resources during construction within the PDAs</p> <p>Moderate - partial loss or alteration to archaeological and historic resources during construction within the PDAs</p> <p>High – total loss or alteration to archaeological and historic resources during construction within the PDAs</p>
Spatial Extent		<p>Project – direct effect is only measurable within the confines of the PDAs</p> <p>Local – direct effect is measurable within the confines of the LAAs</p> <p>Regional – direct effect is measurable greater than 1 km of the LAAs</p>
Duration		<p>Immediate – direct effect is measurable for the construction phase or up to 1 year from construction initiation</p> <p>Short – direct effect is measurable for 1-5 years</p> <p>Medium – direct effect is measurable for 6-15 years</p> <p>Long – direct effect is measurable for 16+ years</p>
<p>Notes: *For all VCs, a negligible magnitude effect is defined as no measurable change.</p>		



6.0 ENVIRONMENTAL EFFECTS ASSESSMENT

The following sections describe the assessment of environmental effects on VCs. The construction phase of the Project was primarily considered for each VC because it will be the most impactful phase of the Project; however, where effects may carry into the operational phase of the Project, this has been identified where applicable. Potential effects are described, followed by mitigations, and residual effects.

Table 6-1 summarizes the valued components and their potential associated residual effects resulting from the Project.



MILL CREEK RAVINE PARK TRAIL REHABILITATION, EDMONTON, ALBERTA

Environmental Effects Assessment
May 2019

Table 6-1 Residual Effect Characterization Summary for VCs

Valued Component	Effect	Residual Effect Characterization			
		Direction	Magnitude	Spatial Extent	Duration
<i>Hydrology and water quality</i>	Change in hydrology and water quality	Adverse	Low (Sites 1 and 2) Moderate (Site 3)	Project (Sites 1 and 2) Local (Site 3)	Immediate (Sites 1 and 2) Medium (Site 3)
<i>Geology, soils and geomorphology</i>	Change in soil quality and quantity	Adverse	Low (All Sites)	Local (All Sites)	Long (All Sites)
	Change in slope stability	Adverse	Low (All Sites)	Local (All Sites)	Long (All Sites)
<i>Vegetation</i>	Change in plant community composition	Adverse	Moderate (Sites 1 and 2)	Local (Sites 1 and 2)	Long (Sites 1 and 2)
		Positive	Low (Site 3)	Project (Site 3)	Long (Site 3)
	Tree mortality	Adverse	Moderate (Sites 1 and 2) Low (Site 3)	Local (Sites 1 and 2) Project (Site 3)	Long (Sites 1 and 2) Immediate (Site 3)
	Introduction and/or spread of weed species	Adverse	Low (All Sites)	Local (All Sites)	Long (All Sites)
<i>Wildlife</i>	Change in mortality risk	Adverse	Moderate (All Sites)	Project (All Sites)	Short (All Sites)
	Change in habitat	Adverse	Moderate (Sites 1 and 2)	Local (All Sites)	Short (All Sites)
	Change in movement	Adverse	Moderate (All Sites)	Local (All Sites)	Short (All Sites)
<i>Fish and Fish Habitat (Site 3 only)</i>	Change in fish mortality risk	Adverse	Low	Project	Immediate
	Change in fish habitat	Adverse	Low	Project	Immediate
	Change in sediment concentration	Adverse	Low	Project	Immediate
<i>Noise</i>	Change in acoustic setting	Adverse	Low (All Sites)	Local (All Sites)	Negligible (All Sites)
<i>Aesthetics</i>	Change in the quality of views	Adverse	Low (All Sites)	LAA (All Sites)	Short (All Sites)
<i>Archeological and historical resources</i>	Loss or damaging of archaeological and historic resources	Neutral	Negligible (All Sites)	Project (All Sites)	Negligible (All Sites)
Notes: -For all VCs, a negligible magnitude effect is defined as no measurable change.					



6.1 HYDROLOGY AND WATER QUALITY

The following sections discuss effects to hydrology and water quality within the LAAs resulting from the Project.

6.1.1 Potential Effects

The potential effects to hydrology and water quality are change in hydrology and change in water quality.

Change in hydrology

Potential effects to hydrology may arise during construction. At Sites 1 and 2, changes in hydrology may result from any grading and/or excavation activities that occur in the PDAs. These changes may also occur from inadequate design of drainage within the PDAs. However, these activities will be minimal as the trails at both sites are designed to follow the existing grade as much as possible. At Site 3, changes in hydrology will result from the in-stream works associated with the bank armouring installation. There will be construction phase and operational phase effects from this portion of the Project.

Change in water quality

Potential effects to water quality may occur through the introduction of deleterious substances from construction activities into Mill Creek. For example, soil from topsoil stockpile or hydrocarbon leaks from construction vehicles or machinery discharged in the untreated stormwater drainage system during a storm event may result in a change in water quality.

6.1.2 Mitigation Measures

Change in hydrology and water quality

Mitigation measures that will be employed to address effects associated with hydrology and water quality include:

- Construction at Site 3 will take place under frozen conditions to minimize potential for sedimentation release into Mill Creek. If construction under non-frozen conditions is required, an isolation system will be installed to control Mill Creek's flow.
- Natural drainage features will be protected from the influx of increased sedimentation resulting from construction activities (ESC measures)
- Excavated materials will be managed to prevent loose material from reaching Mill Creek
- Topsoil stockpile will not be located near entries of the stormwater drainage system
- Machinery and equipment will be kept in good working order, with limited idling
- Permanent and interim ESC measures will be implemented as needed throughout the construction phase

6.1.3 Residual Effects

Residual effects from the construction and operational phases of the Project on hydrology and water quality are expected to be in an adverse direction. The most impactful phase will be the construction phase. The effects of the construction phase after mitigations are applied are expected to be of a low magnitude for Sites 1 and 2 because no in-stream works are required, Mill Creek and the Project includes features that facilitate the pre-existing movement of



water within the PDA. Once construction is completed, the hydrology is expected to function in the same way as pre-construction conditions at Sites 1 and 2. While there is some potential for change to water quality at Sites 1 and 2, there is a vegetated space between these PDAs and Mill Creek which are expected to mitigate introduction of sediment to Mill Creek. After mitigations are applied, effects are anticipated to be of a moderate magnitude for Site 3 because of the need for in-stream works. The construction will occur under frozen conditions, but if construction under non-frozen conditions is required, an isolation system will be installed to control the flow of Mill Creek. The spatial extent of the effects will be the Project boundaries for Sites 1 and 2 and will be Local for Site 3. The greater spatial extent for Site 3 is due to the effects of in-stream work and its effect on Mill Creek. In general, the effects of construction activities at Site 3 will be greater than at Sites 1 and 2 based on in-stream works at Site 3. The effects are expected to be for an immediate duration for Sites 1 and 2, and a medium duration for Site 3.

6.2 GEOLOGY, SOILS AND GEOMORPHOLOGY

The following sections discuss effects to geology, soil and geomorphology within the LAAs resulting from the Project.

6.2.1 Potential Effects

The potential effects to geology, soil and geomorphology are change in soil quality and quantity and change in slope stability.

Change in soil quality and quantity and slope stability

During the construction phase, soils may be disturbed by vehicles and/or construction equipment resulting from site preparation and access, or by the Project design itself. These activities may cause localized compaction or rutting, and/or contamination from fuel or chemical spills, and/or triggering the pre-existing slope instability. If left unmitigated, an erosion and/or contamination risk could continue to affect the PDAs through the operational phase. Ongoing erosion and/or the Project design has the potential to result in degradation of the slope stability resulting in a slope failure in the future.

6.2.2 Mitigation Measures

Change in soil quality and quantity and slope stability

Mitigation measures that will be employed to address effects associated with geology, soil and geomorphology include:

- Natural drainage features will be protected from the influx of increased sedimentation resulting from construction activities (ESC measures); excavated materials will be managed to prevent loose material from reaching Mill Creek
- Permanent and interim ESC measures will be implemented as needed throughout the construction phase
- Construction activities will be limited during wet conditions whenever possible to reduce soils compaction, erosion and sedimentation.
- Cuts and fills will be limited because the LAAs intersect with known locations of large-scale relic landslide scarps
- Grading will be limited due to the sensitivity of the LAA and potential of reactivating the slide movements. Grading plans will be reviewed by a geotechnical engineer
- Grade supported structures will not be constructed on uncontrolled fill



- Surface water within the LAAs will not be allowed to collect and pool in order to minimize water infiltration into the soil of the LAAs and avoid affecting overall site stability
- Vibration and construction activities during construction will be controlled to avoid affecting slope stability
- Vegetation clearing, and construction activities will be controlled to avoid affecting slope stability
- All other recommendations provided in the geotechnical investigation completed by Stantec 2018b (Appendix 4) will be implemented

6.2.3 Residual Effects

Residual effects, such as changes in soil quality and quantity and slope stability, from the construction and operational phases of the Project on geology, soil and geomorphology are expected to be in an adverse direction. The most impactful phase will be the construction phase. The effects of the construction phase after mitigations are applied are expected to be of low magnitude because the Project has been designed to facilitate the hydrology in the PDA to continue as before construction, there are well established areas between the proposed trail and the Creek to reduce sediment introduction, and ESC measures will be incorporated wherever needed to reduce potential of increased sediment introduction into the Creek. The spatial extent of effects for all three Sites is local. The residual effects are expected to last for a long duration for all three Sites. General trail construction recommendations listed in Stantec (2018b) have been incorporated in the design phase of the Project thus far and will continue to be implemented through the construction phase.

6.3 VEGETATION

The following sections discuss effects to vegetation within the LAAs resulting from the Project.

6.3.1 Potential Effects

The potential effects to vegetation include change in plant community composition, tree mortality and introduction and/or spread of weed species.

Change in plant community composition

Plant community composition will be directly affected by vegetation removal. Vegetation, including trees (Site 1) and shrubs (Site 2), will need to be cleared within the PDAs and different plants may establish following construction. The Project may indirectly affect community composition by altered moisture, light and soil conditions, and the introduction and/or spread of weeds. Tree and shrub removal may increase light levels and moisture conditions in surrounding communities and soils compaction from vehicle traffic along the access route may alter water infiltration rates and water flow paths. These changes may increase the abundance of some plants and decrease the abundance of others.

Tree Mortality

Further to direct tree removal, accidental damage to trees and shrubs may occur as a result of equipment striking trees or shrubs during construction. Compaction of soil from construction equipment and vehicles moving along the access route within the LAAs and the laydown areas may also damage tree root systems. This damage and the



resulting wounds may increase susceptibility to infection and reduced vigor (health) and potentially lead to tree mortality.

Introduction and/or Spread of Weed Species

Five noxious weed species (Canada thistle, perennial sow thistle, white cockle, common tansy, and scentless chamomile) were observed within the LAAs in low abundances. Because noxious weeds are already present in the LAAs, construction of the Project has the potential to increase the spread of these species and lead to the introduction, establishment and spread of other weeds into the LAAs. Weeds may be accidentally introduced through soil or by attaching to equipment and/or vehicles and can readily colonize following disturbances (Schutte et al. 2013). Increased presence of weeds will alter composition of plant communities by outcompeting native plants.

6.3.2 Mitigation Measures

Mitigation measures that will be employed to address effects associated with vegetation will include:

Change in plant community composition

- Laydown areas will be delineated and flagged to provide visual barriers for construction activities and to confine activities to the Project footprints (e.g., disturbance areas, laydown areas). Any laydown areas situated in manicured green spaces will be remediated upon completion of the construction phase.
- All construction areas, and temporary vegetation clearing (i.e., any cut and fill areas, or areas cleared within the PDAs) will be reclaimed as soon as they are no longer required.
- Revegetation activities should focus on the re-establishment of native vegetation resembling pre-development plant communities. An approved native seed-mix will be used during the revegetation stage in the construction areas to increase the presence of native plant species within the LAAs.
- An ESC plan will be implemented based on Best Management Practices prior to Project execution and will be monitored throughout the duration of Project construction. These measures will be implemented as required, based on site specific conditions.

Tree Mortality

- Tree removal will be reduced to the furthest extent possible in order to preserve the existing woodlands.
- The laydown and construction areas will be delineated and flagged to provide visual barriers for construction activities and confine activities to the Project footprints. Additionally, the placement of the laydown area will be situated in previously disturbed areas on manicured lawn space. There is a well-vegetated area between the proposed trail at Site 1 and Mill Creek which will act as a buffer preventing sedimentation from entering Mill Creek.
- Measures will be taken to ensure construction equipment does not unintentionally contact trees, such as installing hi-vis temporary fencing (e.g., snow fencing) to clearly mark the clearing boundary and laydown areas. Caution should be employed when working near and around trees to minimize disturbance to tree roots. Where tree roots are exposed, matting may be laid to reduce effects to trees.
- In the operational phase, it is recommended that the COE retain certified arborists to direct the pruning and topping of trees in order to restrict the clearing to only what is necessary and restrict potential damage to the pruned trees.



Introduction and/or spread of weed species

- A landscaping plan will be implemented immediately after the completion of construction. Implementing a restoration plan soon after disturbance can reduce the introduction and establishment of undesirable vegetation.
- Construction machinery will be cleaned prior to entering and leaving the LAAs to reduce the potential establishment or spread of weed species in native communities.
- Seeding/planting soon after soil disturbances can reduce the spread, establishment, and development of weed species within disturbed areas. The time which soil is exposed will be reduced to the greatest possible extent.
- Appropriate weed control, guided by a qualified professional, will be employed to control continued establishment and spread of weed populations during construction and rehabilitation of temporary features (i.e., laydown area). Potential weed control measures include (but are not limited to): mechanical, chemical and hand-pulling. Each of these treatments have limitations based on the species requiring management, plant ecology, location of the weed (proximity to desirable grasses, shrubs, trees or forbs), seasonality and timing. For example, a weed management strategy common in the COE is mowing. Mowing can be a successful treatment provided that these activities are dictated by the ecology of the weed. Specifically, whether propagules (root material, bud, sucker or seeds) are a concern.
- The contractor will monitor and control the presence of weeds as necessary.

6.3.3 Residual Effects

Residual effects from the construction phase of the Project on vegetation are expected to be in an adverse direction. The effects of the construction phase after mitigations are applied are expected to be of moderate magnitude at Sites 1 and 2 for plant community composition and tree mortality because there will be tree removal required within the footprint of the proposed trails, and the materials planted at the abandoned trails will require time to establish. The residual effects for change in plant community composition and tree mortality will be bound to a local spatial extent for Site 1 and 2 for a long duration (given the time required for vegetation to establish successfully). However, the residual effects for change in plant community composition are anticipated to be positive at Site 3 during the operational phase because there will be native plantings added within the PDA, specifically near the bank armouring. This positive residual effect is anticipated to last for a long duration of time.

Residual effects for introduction and/or spread of weed species are expected to be of low magnitude because there is some potential for weeds to be introduced within a local spatial extent at all three Sites. The residual effects are expected to last for a long duration for all three Sites.

6.4 WILDLIFE

The following sections discuss effects to wildlife within the LAAs resulting from the Project.

6.4.1 Potential Effects

The potential effects to wildlife and fish and fish habitat include change in mortality risk, change in habitat, and change in movements.

Change in Mortality Risk

Change in mortality risk may occur through interaction between wildlife and construction activities, vehicles and/or equipment. Increased traffic and use of heavy equipment may result in potential collisions with wildlife. Wildlife



MILL CREEK RAVINE PARK TRAIL REHABILITATION, EDMONTON, ALBERTA

Environmental Effects Assessment
May 2019

species that cannot move quickly from the affected area, such as small mammals, are more likely to be affected. Vegetation removal may also lead to increased bird mortality as active nests may be destroyed. The wildlife mortality effects are not anticipated to carry through to the operational phase of the Project.

Change in Habitat

Change in habitat may occur through permanent or temporary habitat loss caused by construction activities or a change in habitat suitability caused by sensory disturbance (e.g., noise, light, visual cues, human presence). Vegetation clearing will remove and/or alter areas such that they will no longer support wildlife species in fulfilling their lifecycle requirements. Sensory disturbance (i.e., noise) from construction activities, operation and maintenance and human presence post-construction may also displace some wildlife species from their habitats.

Change in Movement

Potential effects to wildlife movements may result from sensory disturbance of the PDAs during construction. This disturbance has the potential to disrupt habitat connectivity and reduce landscape permeability. For example, temporary physical barriers such as silt fences used as ESC may change wildlife movements in the LAA during construction. Noise and the accrued presence of construction personnel during the construction phase may lead to sensory disturbances for wildlife. Sensory disturbance will be greater during the day during active construction and will be lower at night, when construction activities have ended for the day.

6.4.2 Mitigation Measures

Mitigation measures that will be employed to address effects associated with wildlife include:

Change in Mortality Risk

- Where feasible, construction activities will avoid the general nesting periods for migratory and non-migratory birds (March 1 to August 31). These dates are based on knowledge of most common early nesting raptors (FAN 2007), guidance from AEP, professional experience, and guidance from Environment Canada and Climate Change (2016).
- Project staff will follow posted speed limits. Truck traffic will be limited, wherever possible, to daylight hours to avoid key wildlife activity periods (e.g. dawn and dusk). Project-related traffic management in the LAAs will be used to reduce potential increases in wildlife mortality risk.
- Waste products will be stored in secure containers and transported to appropriate facilities during construction.
- Temporary fencing around the perimeter of the PDAs will discourage wildlife entering during the construction phase. If appropriate, Fish and Wildlife personnel will be contacted to assist in dealing with trapped wildlife.

Change in Habitat

- The clearing footprints have been designed to remain constrained to the smallest section possible within the LAA. During the construction phase, trails will be field fit to avoid removal of trees to the extent possible.
- Native vegetation will be used during the rehabilitation stage to increase suitable habitat for wildlife in the construction affected areas.
- Contamination of wildlife habitat will be avoided by implementing spill control measures and the Spill Contingency Plan. Adhere to clean-up and remediation standards. Spills will be reported to the 24-Hour Alberta Environmental Hotline at 1-800-222-6514 and other applicable agencies. The COE reporting requirements will be followed when reporting spills.



MILL CREEK RAVINE PARK TRAIL REHABILITATION, EDMONTON, ALBERTA

Environmental Effects Assessment
May 2019

- Construction activities associated with the Project will be restricted to specific hours as per the COE's Community Standards Bylaw 14600.
- Maintenance will follow standard operation procedures for gravel trails in the NSRV as determined by the COE.

Change in Movement

- The use of an approved seed-mix will be implemented during the rehabilitation of the construction areas to increase cover for wildlife and support wildlife movement. The use of native vegetation will also increase cover for wildlife movements.
- Construction will be temporary and short-term. The Project is anticipated to last approximately two to four weeks at each Site following commencement to reduce negative effects on wildlife.
- Fencing around construction area will be removed when trail construction is complete at Site 1 and 2 and bank armouring is complete at Site 3, to reduce effects on ecological connectivity.
- Noise abatement measures will be implemented where necessary.
- Construction activities associated with the Project will be restricted to specific hours as per the COE's Community Standards Bylaw. This will also reduce the length of the daily sensory disturbance period.

6.4.3 Residual Effects

Residual effects from the construction of the Project on wildlife are expected to be in an adverse direction. The effects of the construction phase after mitigations are applied are expected to be of moderate magnitude at all three Sites for change in mortality risk as the presence of construction vehicles and equipment is likely to have the same effect at all Sites. For change in habitat and change in movement, the residual effects of the construction phase after mitigations are applied are expected to be of moderate magnitude at the three Sites. The construction phase will very short and temporary, lasting approximately two to four weeks at each site. At Site 1 and 2, the abandoned trails will be revegetated which will create habitat and there is limited change in size of habitat loss. Restoration of the existing trail will provide some new habitat for small mammals and feeding opportunities for predatory birds in the area. Given the Project's close proximity to busy roadways, and the LAAs previously disturbed areas, it is expected that wildlife will be habituated to some forms of sensory disturbance, like noise and human presence. Site 3 has a low magnitude because the existing trail will be rehabilitated (i.e., there will be no new trail constructed) and minimal change in wildlife habitat will occur. The residual effects are anticipated to be bound to the PDA (project) for change in mortality risk and for change in habitat for Sites 1 and 2. Change in habitat at Site 3 is anticipated to be negligible as there is no construction of new trail at this Site. The residual effect for change in movement is anticipated to be within the LAA (local) for all three Sites. As the construction phase is temporary, the residual effects of the activities are anticipated to be short in duration for all three sites, and negligible for Site 3.

6.5 FISH AND FISH HABITAT

The following sections discuss effects to fish and fish habitat within the LAA as a result of the Project.

6.5.1 Potential Effects

Potential effects to fish and fish habitat are change in fish mortality risk, change in fish habitat and change in sediment concentration at Site 3 only.



MILL CREEK RAVINE PARK TRAIL REHABILITATION, EDMONTON, ALBERTA

Environmental Effects Assessment
May 2019

Change in fish mortality risk

Change in fish mortality risk may occur during the in-stream construction work. Potential fish mortality risk may occur during the in-stream work; however, the work will be completed with an isolation system in place to control the creek flow. In-stream construction is likely to occur under frozen conditions, however, if construction occurs in non-frozen conditions, fish salvage activities are anticipated to have a change in fish mortality risk.

Change in fish habitat

Change in fish habitat may occur through changes to several elements of the aquatic environment including, food supply, habitat structure and cover, nutrient concentrations, access to habitat, and water temperature. During the construction phase, changes to these elements may occur due to ground disturbance required within the PDA, riparian planting, placement/removal of material or structures in the water. Changes to these elements may result in change in timing, duration, and frequency of flow.

Change in sediment concentration

Change in sediment concentrations may occur due to vegetation clearing, riparian planting, grading activities, use of industrial equipment, placement/removal of material or structures in the water, and any other ground disturbance activities. Sediments can contain both nutrients and contaminants and can suspend or settle within the river. Sediments can affect the ecological conditions of the water and affect fish by changing visibility, sunlight penetration and may result in damage to fish gills. Additionally, sediments have the potential to reduce the quality and availability of spawning and fish rearing habitats. The highest risk of sedimentation is anticipated to occur during the construction phase.

6.5.2 Mitigation Measures

Mill Creek at Site 3 is a Class D water body with no applicable restricted activity period. Mitigation measures that will be employed to address effects associated with fish and fish habitat include:

Change in fish mortality risk

- Construction will be completed under frozen conditions, if possible. If construction is to occur in non-frozen conditions, a fish salvage will be completed before the isolation is installed and construction begins. The fish salvage will be conducted in accordance with the license provided by Alberta Environment and Parks.
- Machinery should be washed, refueled and serviced, and fuel should be stored, such that deleterious substances do not enter the water.
- Areas within the PDA disturbed by construction activities will be remediated immediately upon completion of construction works.

Change in fish habitat

- In-stream works will be conducted under frozen conditions. Where it is not possible to construct under frozen conditions, isolation of the following channel will be installed. Isolation measures may include sandbag dams, aqua dams, etc.
- Should water diversion be required during construction (under non-frozen conditions), it will be completed such that the pumped-out water is filtered prior to re-entering a waterbody.



MILL CREEK RAVINE PARK TRAIL REHABILITATION, EDMONTON, ALBERTA

Environmental Effects Assessment
May 2019

- Measures for containing and stabilizing waste material (e.g., construction waste and materials, accumulated debris, uprooted or cut aquatic plants, etc.) above the high-water mark will be developed and implemented by the contractor.
- Mill Creek bank will be covered with topsoil and plantings (see Appendix 1).

Change in sediment concentration

- If construction is not completed under frozen conditions, construction activity should avoid wet, windy and rainy periods that may increase erosion and sedimentation.
- An ESC plan will be developed and implemented by the contractor. ESC measures will be regularly inspected and maintained as needed.
- A turbidity monitoring program implemented and led by a Qualified Aquatic Environment Specialist and reviewed in detail with the contractor. The program will include specifications for sampling locations, frequency, and detection response procedures.

6.5.3 Residual Effects

Residual effects from the construction phase of the Project on fish and fish habitat are expected to be in an adverse direction for change in fish mortality risk, fish habitat and sediment movement. The construction phase is anticipated to be the most impactful phase of the Project. The effects of the construction phase after mitigations are applied are expected to be of low magnitude because construction will be completed under frozen conditions, and if required, stream flow isolations will be installed. Further, if construction is not completed under frozen conditions, a fish salvage will be completed to control any potential fish mortality caused by construction. The residual effects are anticipated to be bound to the PDA (project). The residual effects of the activities are anticipated to be immediate in duration (lasting for the construction phase) because the construction phase will be temporary.

6.6 NOISE

The following sections discuss effects to noise within and surrounding the LAAs resulting from the Project. For the effects assessment of this VC the construction phase is only considered as it will be the most impactful stage of the Project. There are no activities from the Project anticipated to carry through to the operational phase.

6.6.1 Potential Effects

The potential effects to noise are change in existing acoustic setting.

Change in Acoustic Setting

Potential effects to acoustic setting in the LAA are expected to arise from Project construction activities such as the use of equipment, increase in traffic and other construction activities. The result of these activities is expected to increase noise levels in the LAA during the construction phase. Considering that Site 2 and Site 3 are within 100 m of high traffic roads, residents living and using the Mill Creek trail system are likely habituated to an elevated noise level caused by vehicle traffic on these busy roads. Construction noise could also adversely affect wildlife (See Section 6.4).



6.6.2 Mitigation Measures

Change in Acoustic Setting

Mitigation measures that will be employed to address effects associated with noise include:

- All work will be limited to normal working hours in accordance with COE Community Standards Bylaw 14600.
- Reasonable efforts will be made to minimize noise disturbance at all times.
- Machinery and equipment will be kept in good working order, with limited idling.

6.6.3 Residual Effects

Residual effects of the construction phase of the Project on noise are anticipated to be of low magnitude. The spatial extent of the effects will be local and of a negligible duration. During construction, noise may increase within the construction vicinity (LAA) when construction is active, and equipment is used; however, these effects will be reduced by implementing mitigation measures. Once construction is completed, the noise level in LAA will return to pre-construction levels.

6.7 AESTHETICS

The following sections discuss effects to aesthetics within the LAA resulting from the Project.

6.7.1 Potential Effects

The potential effect to aesthetics is change of the quality of views in the LAAs.

Change of the Quality of Views

Construction activities associated with the Project will result in adverse changes to the visual setting of the LAAs. The presence of construction vehicles, equipment and personnel will decrease the quality of the visual setting. The removal of vegetation, stripping of topsoil and interim ESC measures will also contribute to decreasing the quality of the visual setting in the LAAs. The adverse effects to the aesthetic VC are expected to be restricted to the construction activity period.

6.7.2 Mitigation Measures

Mitigation measures that will be employed to address effects associated with aesthetics include:

- The extent of vegetation and tree clearing, and duration of construction activities will be reduced to the extent possible.
- A detailed landscape plan will be executed as soon as possible following completion of construction activities.
- Interim ESC measure will be designed and placed to blend with the existing surroundings to the greatest extent possible, without compromising their functions to act as visual barriers for trail users and as wildlife deterrents.
- Revegetation will incorporate native plant species and will be focused on creating species assemblages that resemble pre-development plant communities.



6.7.3 Residual Effects

Residual effects of the construction phase on aesthetics are expected to be of low magnitude, at a local spatial extent for a short duration at Sites 1 and 2. The effects are anticipated to be negligible at Site 3 because there are no changes proposed to the existing trail alignment; as such, the quality of views is not anticipated to change. In the operational phase, the residual effects of the Project are anticipated to be neutral and negligible. Sites 1 and 2 have been designed to mimic the existing trail system, and is within close proximity of the existing trail, and Site 3 is not changing in alignment at all.

6.8 ARCHAEOLOGICAL AND HISTORIC RESOURCES

The following sections discuss effects to archaeological and historic resources within the LAAs resulting from the Project.

6.8.1 Potential Effects

Potential effects to archaeological and historic resources are the permanent loss or damaging of archaeological and historic resources in the LAAs.

Loss or Damaging of Archaeological and Historic Resources

Construction activities may result in potential effects on archaeological and historic resources, including effects to both known and unknown resources of cultural, archaeological, historical and/or palaeontological significance. Potential effects are the loss of site contents and contexts, if potential effects are not mitigated. Once *ACT (Historical Resource Act)* clearance has been provided, all recommendations provided by the *ACT* will be implemented.

6.8.2 Mitigation Measures

- All recommendations provided by ACT will be implemented.

6.8.3 Residual Effects

Although Project effects can occur to archaeological resources, site-specific effects are regulated at the provincial level. The regulatory agencies independently assess the scientific value of archaeological sites and determine the need for, and scope of, mitigation measures, and issue the clearance under the Act. As such, Project-specific effects on historical resources are continually mitigated to the standards established by the provincial regulators. In this context, after implementation of the required mitigation measures issued by the regulatory agency, residual adverse effects to archaeological and historic resources are not anticipated.



7.0 LIMITATIONS AND QUALIFICATIONS

In conducting the investigation and rendering our conclusions, Stantec gives the benefit of its best judgment based on its experience and in accordance with generally accepted professional standards for this type of investigation. This report was submitted with the best information to date and on the information provided. The conclusions made within this report are a professional opinion, not a certification of the environmental conditions within the LAA, and no other warranty, expressed or implied, is made. This report has been prepared for the exclusive use of the City of Edmonton for the purposes of assessing the current state of the LAAs. Any use a third party makes of this report, or any reliance on or decisions to be made on it, are the responsibility of such third parties. Stantec accepts no responsibility for damages, if any, suffered by any other third party as a result of decisions made or actions based on this report. Our conclusions are limited by the following:

- Some of the information contained within this report was provided by agencies and organizations external to Stantec. While Stantec cannot guarantee the information provided by external parties, this information has been assumed to be correct.
- The information contained within this report is based on the design available at the time of report preparation (development concept received on January 2018). Design drawings will continue to be modified and added as the detailed design process continues but are intended to not depart significantly from the information presented in this report. Should significant changes to the drawings be made in the future, an amendment to this report may be required.
- The investigation was limited to those parameters specifically outlined in this report.
- The Contractor will be responsible for determining the ultimate construction schedule and means of construction for the Project; however, should significant changes to construction timing and/or methodology from that presented within this report be proposed or required, it is the responsibility of the Contractor to confirm with all applicable regulatory agencies or bodies that this is acceptable. It is also the responsibility of the contractor to obtain all applicable amendments to approvals and/or permits that may have previously been obtained based on the information presented within this report.



MILL CREEK RAVINE PARK TRAIL REHABILITATION, EDMONTON, ALBERTA

References
May 2019

8.0 REFERENCES

Alberta Conservation Information Management System (ACIMS). 2015. *ACIMS GIS Data Layers*.

ACIMS 2017a. List of tracked and watched elements. Accessed February 2018 at:
<https://www.albertaparks.ca/albertaparksca/management-land-use/alberta-conservation-information-management-system-acims/tracking-watch-lists/>.

Alberta Environment. 1974. *Flood Plain Study of the North Saskatchewan River through Edmonton*. Samide, G.W. and S.A. Lowe. Environmental Engineering Support Services.

Alberta Environment and Parks (AEP). 2012. *Flood Hazard Map Application*. Accessed February 13, 2018 at:
<http://maps.srd.alberta.ca/FloodHazard/viewer.ashx?viewer=Mapping&community=Edmonton>

AEP. 2012. Code of Practice for Watercourse Crossings – St. Paul Management Area Map. Accessed February 14, 2018 at: <http://aep.alberta.ca/water/legislation-guidelines/water-codes-of-practice.aspx>.

AEP. 2018a. Species at Risk Public Registry; A to Z Species Index. Accessed February 14, 2018 at:
http://www.registrelep-sararegistry.gc.ca/sar/index/default_e.cfm.

AEP. 2018b. Wild Species Status Search. Accessed February 14, 2018 at: <http://aep.alberta.ca/fish-wildlife/species-at-risk/wild-species-status-search.aspx>.

AEP. 2017. *Access FWMIS data*. Accessed February 2018 at: <http://esrd.alberta.ca/fish-wildlife/fwmis/access-fwmis-data.aspx>.

Alberta Energy Regulator. 2018. Coal Mine Map Viewer. Accessed February 2018 at:
<http://mapviewer.aer.ca/Html5/Index.html?viewer=aercoalmine>.

Associated Engineering (AE). 2016a. Mill Creek Erosion Study. Edmonton, Alberta. Prepared for: City of Edmonton.

AE. 2016b. Mill Creek Ravine Early and Late Season Rare Plant Survey – June and August 2016. Prepared for the COE.

Bayrock, L.A. and Hughes, G.M. (1962): Surficial geology of the Edmonton district, Alberta; Res. Coun. Alberta Rept. 62-6, 44 pages.

Bayrock, L.A. and Berg, T. E. (1966): Geology of the City of Edmonton; Part 1: Central Edmonton. Res. Coun. Alberta Rept. 62-1, 30 pages.

Canadian Environmental Assessment Agency (CEAA). 2012. Technical guidance for assessing cumulative environmental effects under the Canadian Environmental Assessment Act, 2012. Accessed February 2018 at: <https://www.ceaa-acee.gc.ca/default.asp?lang=En&n=B82352FF-1&offset=4&toc=hide>.

City of Edmonton (COE). 1990. Ribbon of Green Concept Plan. Edmonton.



MILL CREEK RAVINE PARK TRAIL REHABILITATION, EDMONTON, ALBERTA

References

May 2019

COE. 1992. Ribbon of Green Master Plan. Edmonton.

COE. 2000. *A guide to environmental review requirements in the North Saskatchewan River Valley and Review System*. Planning and Development Department, Planning and Policy Services Branch, City of Edmonton. Edmonton, AB.

COE. 2008a. *Floodplain Protection Overlay Map*. City of Edmonton Zoning Bylaw 12800, Section 812. Planning and Development Branch.

COE. 2008b. *Biodiversity report*. City of Edmonton. Edmonton.

COE. 2010a. Corporate Tree Management Policy C456A.

COE. 2010b. *The Way We Grow Municipal Development Plan, Bylaw 15100*. Edmonton.

COE. 2010c. *The Way We Live: Edmonton's people plan*. Edmonton.

COE. 2011. *The Way We Green, City of Edmonton Environmental Strategic Plan*. Edmonton.

COE. 2013. Drawing LA303: Granular Walkway. City of Edmonton.

COE. 2014. *The Way Ahead (Edmonton's Strategic Plan)*. Edmonton.

COE. 2017a. Land Use Zones Summary: Urban Services Zones. Accessed on February 14, 2018 at: https://www.edmonton.ca/city_government/urban_planning_and_design/land-use-zones-summary.aspx#Urban_Services_Zones.

COE. 2017b. Zoning Map. Accessed on February 14, 2018 at: <https://maps.edmonton.ca/map.aspx?lookingFor=Zoning>.

COE. 2017c. Community Standards Bylaw, Bylaw No. 14600. Edmonton.

COE. 2017d. North Saskatchewan River Valley Area Redevelopment Plan (Bylaw No. 7188). City of Edmonton. Edmonton.

COE. 2017e. Design and Construction Standards – Volume 5 Landscaping. Available at: https://www.edmonton.ca/city_government/documents/Design_and_Construction_Landscaping.pdf

Environment Canada and Climate Change. 2016. General nesting periods of migratory birds in Canada. Accessed February 2018 at: https://www.ec.gc.ca/paom-itmb/default.asp?lang=En&n=4F39A78F-1#_01_2

Environmental Protection and Enhancement Act, R.S.A. 2000

EPEC Consulting Western Ltd. 1981. North Saskatchewan River Valley and Ravine system biophysical study. Edmonton.

Federation of Alberta Naturalists (FAN). 2007. *The Atlas of Breeding Birds of Alberta: a second look*. Federation of Alberta Naturalists, Edmonton.



MILL CREEK RAVINE PARK TRAIL REHABILITATION, EDMONTON, ALBERTA

References

May 2019

Historical Resources Act. R.S.A. 2000. c. H-9.

Integrated Taxonomic Information System (ITIS). 2016. *Integrated Taxonomic Information System*. Accessed February 2018 at: www.itis.gov.

Kathol, C.P. and R.A. McPherson. 1975. Urban Geology of Edmonton, Alberta Research Council Bulletin 32.

Migratory Birds Convention Act, 1994. S.C. 1994, c. 22.

Migratory Birds Regulations. C.R.C., c. 1035. (Migratory Birds Convention Act, 1994).

North Saskatchewan Watershed Alliance (NSWA). 2005. Chapter 3.0 The North Saskatchewan in Alberta. Accessed February 14, 2018 at: http://nswa.ab.ca/sites/default/files/documents/north_sasatchewan_in_alberta.pdf.

NSWA. 2012. 12 Subwatersheds, Beaverhill Watershed. Accessed February 14, 2018 at: <http://www.nswa.ab.ca/content/12-subwatersheds>.

Natural Regions Committee (NRC). 2006. *Natural regions and subregions of Alberta*. Compiled by D.J. Downing and W.W. Pettapiece. Government of Alberta. Edmonton.

Noble, B.F. 2006. Introduction to environmental impact assessment: a guide to principles and practice. Toronto. Oxford University Press.

Prior, G.J., Hathway, B., Glombick, P.M., Pană, D.I., Banks, C.J., Hay, D.C., Schneider, C.L., Grobe, M., Elgr, R. and Weiss, J.A. 2013. Bedrock geology of Alberta. Alberta Energy Regulator. AER/AGS Map 600, scale 1:1 000 000.

Schutte, B.J., B.J. Tomasek, A.S. Davis, L. Adneresson, D.L. Benoit, A. Cirujeda, J. Dekker, F. Forcella, J.L. Gonzalez-Andujar, F. Graziani, A.J. Murdoch, P. Neve, I.A. Rasmussem, B. Sera, J. Salonene, F. Tei, K.S. Torressen and J.M. Urbano. 2013. An investigation to enhance understanding of the stimulation of weed seedling emergence by soil disturbance. *Weed Research* 54:1-12.

Solstice Canada Corp. (Solstice). 2017. City of Edmonton Environmental Sensitivities Project Mapping and Analysis Methodology – Final Report. Prepared for: City of Edmonton Parks + Biodiversity, Edmonton, AB.

Species at Risk Act. S.C. 2002, c. 29.

Stantec Consulting Ltd (Stantec). 2018a. Mill Creek Ravine Park Trail Rehabilitation - Site Assessment & Design Analysis Report. Prepared for the COE.

Stantec. 2018b. Mill Creek Ravine Trail Rehabilitation. Geotechnical Report. Prepared for the COE.

Strong, W.L., J.L. Kansas, K.J. Van Tighem, and B. MacCallum. 1985. A biophysical inventory and analysis of the Fort Saskatchewan and Devon restricted development areas. Edmonton.

Strong, W.L. and B. MacCallum. 1984. A preliminary vegetation and wildlife analysis of the Edmonton – Fort Saskatchewan restricted development area. Edmonton.



MILL CREEK RAVINE PARK TRAIL REHABILITATION, EDMONTON, ALBERTA

References

May 2019

Thurber Engineering Ltd. (Thurber). 2005. Condominium Development, Whyte Avenue and 93rd Street, Edmonton, Alberta, Top of Bank Set Back Assessment. File No. 19-4380-5. Prepared for: City of Edmonton.

Weed Control Act. S.A. 2008, c. W-5.1.

Weed Control Regulation. Alta. Reg. 19/2010.

Wheatley, M. and J. Bentz. 2002. *A Preliminary Classification of Plant Communities in the Central Parkland Natural Subregion of Alberta*. Alberta Sustainable Resource Development, Public Lands Division, Resource Data Branch, Edmonton.

Wildlife Act. R.S.A. 2000, c. W-10.



APPENDIX 1

Preliminary Drawings

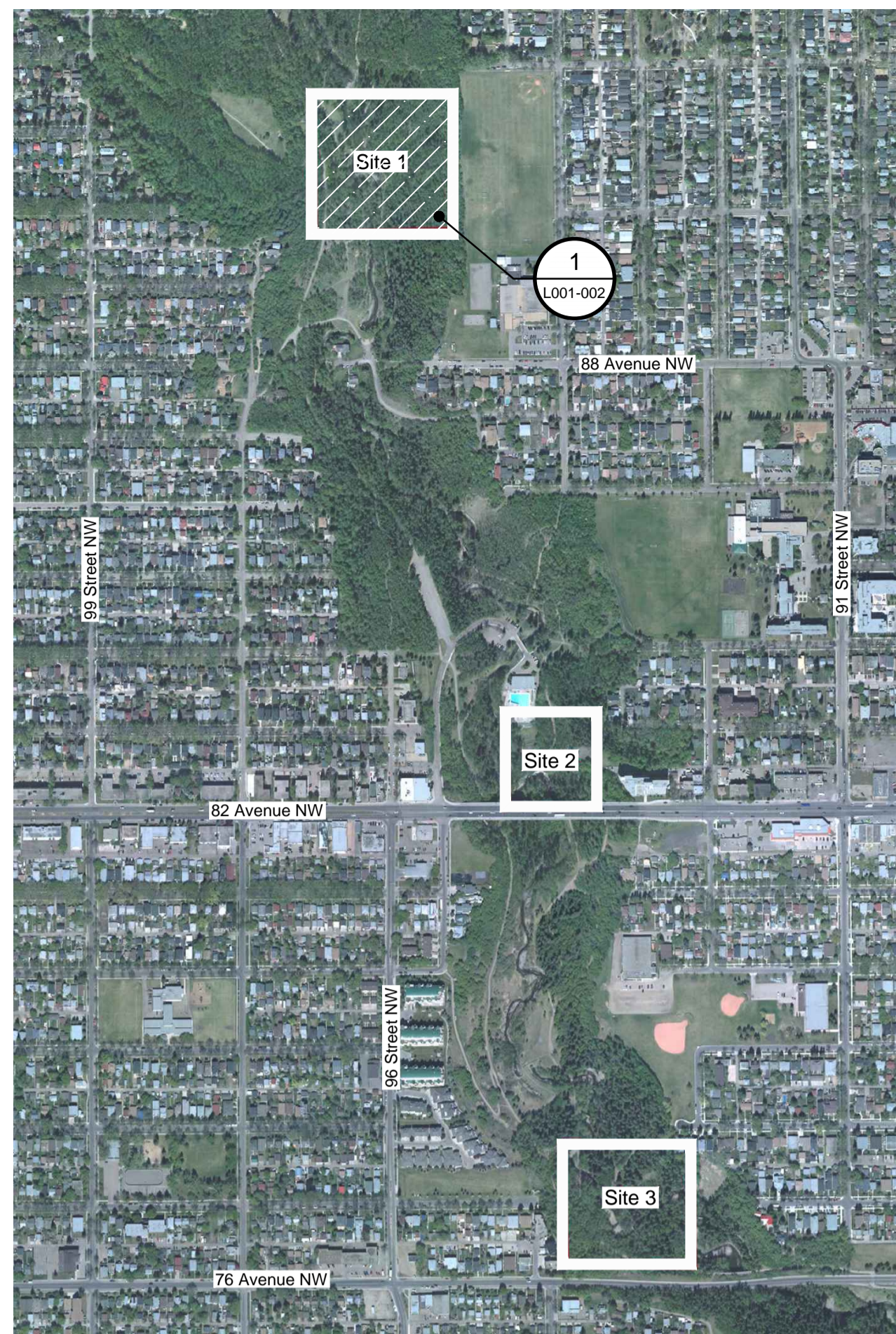

KEY PLAN
SCALE: N.T.S.



1 SITE #1 OVERALL PLAN
SCALE: 1:1000



Stantec Consulting Ltd.
10160 - 112 Street
Edmonton AB Canada
Tel. 780.917.7000
www.stantec.com

Copyright Reserved
The Contractor shall verify and be responsible for all dimensions. DO NOT scale the drawing - any errors or omissions shall be reported to Stantec without delay. The Copyrights to all designs and drawings are the property of Stantec. Reproduction or use for any purpose other than that authorized by Stantec is forbidden.

- Legend**
- EXISTING GRANULAR TRAIL
 - - - LIMIT OF CONSTRUCTION
- Notes**
- UTILITY SETBACKS**
LANDSCAPE CONTRACTOR TO CALL 'ALBERTA ONE-CALL' AT 1-800-242-3447 TO HAVE ALL EXISTING SITE UTILITIES LOCATED PRIOR TO CONSTRUCTION AND PLANT NO CLOSER THAN THE FOLLOWING DIMENSIONS FROM THE SERVICES:
1. 1.0 m FROM POWER LINES
 2. 3.5 m FROM ALL POWER HARDWARE
 3. 1.8 m FROM WATER MAINS, WATER VALVES, MANUAL AIRVENTS, AND SERVICES
 4. 2.0 m FROM SEWER MAINS, AND MANHOLES
 5. 1.8 m FROM SEWER SERVICES
 6. 1.5 m FROM GAS (NO TREES WITHIN EASEMENT)
 7. 7.5 m FROM STREET CORNERS.
 8. 3.5 m FROM FIRE HYDRANTS.
 9. 1.5 m FROM DRIVEWAYS
 10. 1.5 m FROM ALLEY ACCESSES
 11. 1.0 m FROM SIDEWALKS
 - OR AS PER APPROVED ENG. CROSS SECTIONS
 12. 3.5 m FROM TRANSIT ZONES
 13. 3.0 m FROM PRIVATE PROPERTY BOUNDARY
 14. 1.25 m FROM COLLECTOR ROAD CURB FACE
 15. 1.25 m FROM LOCAL ROAD CURB FACE
 16. 2.0 m FROM ARTERIAL ROAD CURB FACE
 17. 3.5 m FROM YIELD AND STOP SIGNS
 18. 3.5 m FROM BUS STOP SIGNS
 19. 2.0 m FROM ALL OTHER SIGNS
 20. 1.0 m FROM OTHER UNDERGROUND UTILITIES
 21. 3.5 m FROM TELUS PEDESTALS
 22. 2.0 m FROM TELUS DUCT STRUCTURE
 23. 1.0 m FROM TELUS CABLE FACILITIES

LANDSCAPE CONTRACTOR IS RESPONSIBLE FOR DAMAGES AND LIABILITIES INCURRED BY DAMAGES TO SITE UTILITIES.

Development Engineer, Sustainable Development			
Approvals			YY.MM.DD
Revision	By	Appd.	YY.MM.DD
1. FIRST SUBMISSION (60%)	DW	NGS	18.05
Issued	By	Appd.	YY.MM
File Name: LA_M1Creek.dwg	DW	CB	NGS
	Dwn.	Chkd.	Dsgn.
			18.03.13
			YY.MM.DD

Permit-Seal



Natalie
Goulet-Sorenson

Client/Project
CITY OF EDMONTON

MILL CREEK RAVINE PARK
TRAIL REHABILITATION
Edmonton, Alberta

Title
SITE #1 OVERALL PLAN

Project No. 1161106255 Scale 1:1000

Drawing No. L001-001

V:\1161\active\1161106255\drawing_Landscape\LA_M1Creek.dwg

2018-12-05 3:32pm BY: DWIGLSEWORTH 1 of 10

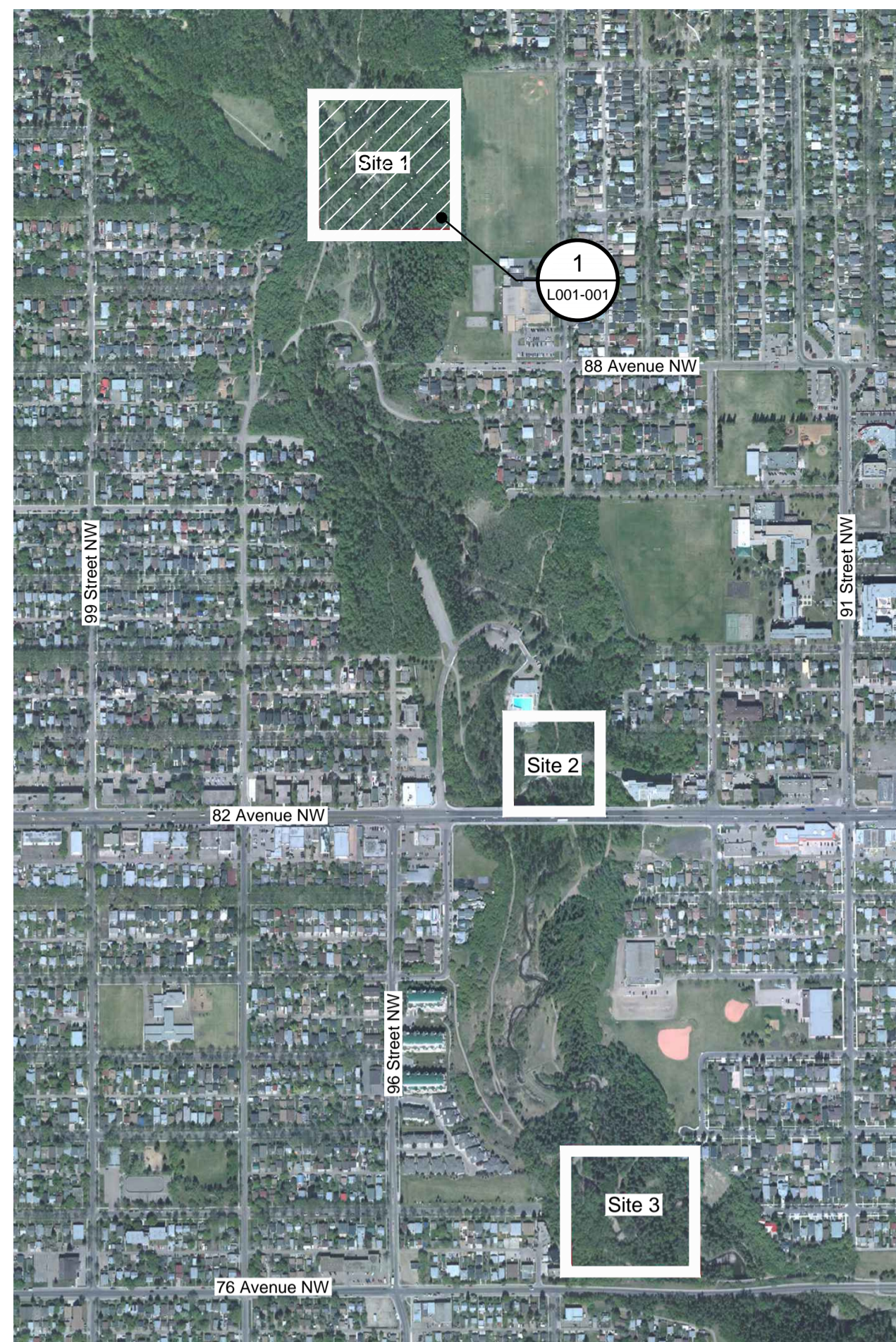

KEY PLAN
SCALE: N.T.S.

LAYOUT AND GRADING NOTES:

- CONTRACTOR TO CALL ALBERTA ONE CALL AT 1-800-242-3447 TO HAVE EXISTING UTILITIES LOCATED PRIOR TO START OF ANY CONSTRUCTION.
- THIS DRAWING IS TO BE READ IN CONJUNCTION WITH THE WRITTEN SPECIFICATIONS, DRAWINGS, AND DETAILS FOR THE PROJECT.
- CONTRACTOR TO ENSURE THAT ALL NECESSARY ARRANGEMENTS ARE MADE WITH THE PIPELINE COMPANIES CONCERNING THE MOVEMENT OF MATERIALS AND EQUIPMENT NEAR ANY PIPELINE RIGHTS OF WAY.
- CONTRACTOR IS RESPONSIBLE FOR THE HOARDING OF ALL TREES WITHIN OR ADJACENT TO CONSTRUCTION AREAS.
- CONTRACTOR IS RESPONSIBLE FOR THE ADJUSTMENT OF ALL EXISTING CATCHBASINS, CATCHBASIN MANHOLES, MANHOLES, WATER VALVES, HYDRANTS, ETC. TO MATCH PROPOSED GRADES.
- ENSURE POSITIVE DRAINAGE IN ALL SWALES AS SHOWN ON PLAN. DO NOT PERMIT POOLING OF WATER IN DRAINAGE SWALE.
- CONTRACTOR IS RESPONSIBLE FOR HAULING OF ALL EXCESS MATERIALS OFF THE SITE.
- CONTRACTOR IS RESPONSIBLE FOR GENERAL SITE CLEAN UP.
- CONTRACTOR IS RESPONSIBLE FOR ANY DAMAGE TO LANDSCAPED AREAS AND MUST MAKE ALL NECESSARY RESTORATIONS AND REPAIRS.
- ALL ANCILLARY WORK NORMALLY ASSOCIATED WITH THIS TYPE OF CONSTRUCTION SHALL BE DEEMED TO BE PART OF THE CONTRACT.
- ALL QUANTITIES ARE APPROXIMATE ONLY.
- GRADES TO BE APPROVED BY LANDSCAPE ARCHITECT PRIOR TO CONSTRUCTION STARTING.
- CONTRACTOR TO HOLD ROUGH GRADES 450 mm BELOW FINISHED GRADE FOR PLANT BEDS, 150mm FOR SEEDDED AREAS, 200 mm FOR WALKS, 100 mm FOR SODDED AREAS.
- STANDARD CONTOUR INTERVAL IS 500mm. SPOT ELEVATIONS AS SHOWN. ALL SPOT ELEVATIONS IN METERS. BERMS AND SLOPES TO BE GRADED SMOOTHLY. ELIMINATE ROUGH SPOTS AND LOW AREAS TO ENSURE POSITIVE DRAINAGE PRIOR TO SEEDING.
- ALL PROPOSED GRADES TO MEET EXISTING GRADES AT PROPERTY LINE WITH A SMOOTH TRANSITION. LIMIT OF GRADING NOT TO EXTEND BEYOND PROPERTY LINE. GRADES TO MEET CURB OR WALK SMOOTHLY. LANDSCAPE ARCHITECT TO APPROVE ROUGH AND FINISHED GRADES.
- MAXIMUM SLOPE OF ANY LANDSCAPED AREA NOT TO EXCEED 33%.
- CONTRACTOR TO TAKE NECESSARY PRECAUTIONS TO PROTECT ALL SITE FEATURES EXISTING AT THE TIME OF CONSTRUCTION UNLESS SPECIFIED FOR DEMOLITION ON THE DRAWING. THIS INCLUDES ALL SURVEY BARS, STAKES OR MONUMENTS. MAKE GOOD ANY DAMAGE.
- ANY AMBIGUITY IN THIS DRAWING OR ACCOMPANYING DETAILS IS TO BE REPORTED TO THE LANDSCAPE ARCHITECT FOR DIRECTION. CONTRACTOR NOT TO PROCEED IN UNCERTAINTY.
- LIMITS OF WORK TO BE CLEARLY UNDERSTOOD BY THE CONTRACTOR PRIOR TO ANY WORK TAKING PLACE ON SITE. CONTRACTOR TO CONTACT LANDSCAPE ARCHITECT FOR CLARIFICATION IF REQUIRED.
- CONTRACTOR TO VISIT SITE TO CONFIRM ALL SITE CONDITIONS PRIOR TO SUBMITTING BIDS. DISCREPANCIES TO BE REPORTED TO LANDSCAPE ARCHITECT FOR CLARIFICATION.
- CONTRACTOR TO VERIFY ALL DIMENSIONS AND REPORT ANY DISCREPANCIES TO THE LANDSCAPE ARCHITECT.
- LAYOUT TO BE APPROVED BY LANDSCAPE ARCHITECT PRIOR TO CONSTRUCTION STARTING.
- ALL MEASUREMENTS ARE IN METERS UNLESS OTHERWISE NOTED.
- CONTRACTOR SHALL SUPPLY ALL MATERIALS IN QUANTITIES SUFFICIENT TO COMPLETE WORK SHOWN ON THESE DRAWINGS. ANY DISCREPANCIES SHALL BE REPORTED TO THE LANDSCAPE ARCHITECT FOR DIRECTION.
- NO SUBSTITUTIONS OF MATERIALS, PRODUCTS OR QUANTITIES WITHOUT PRIOR CONSENT OF LANDSCAPE ARCHITECT.

CLOSED TRAIL NOTES:

- REMEDiate WITH 150mm DEPTH TYPE1 TOPSOIL AND WILLOW WHIPS AT 0.5m² SPACING.
- PRICKLY ROSES AT EACH END OF THE CLOSED TRAIL.

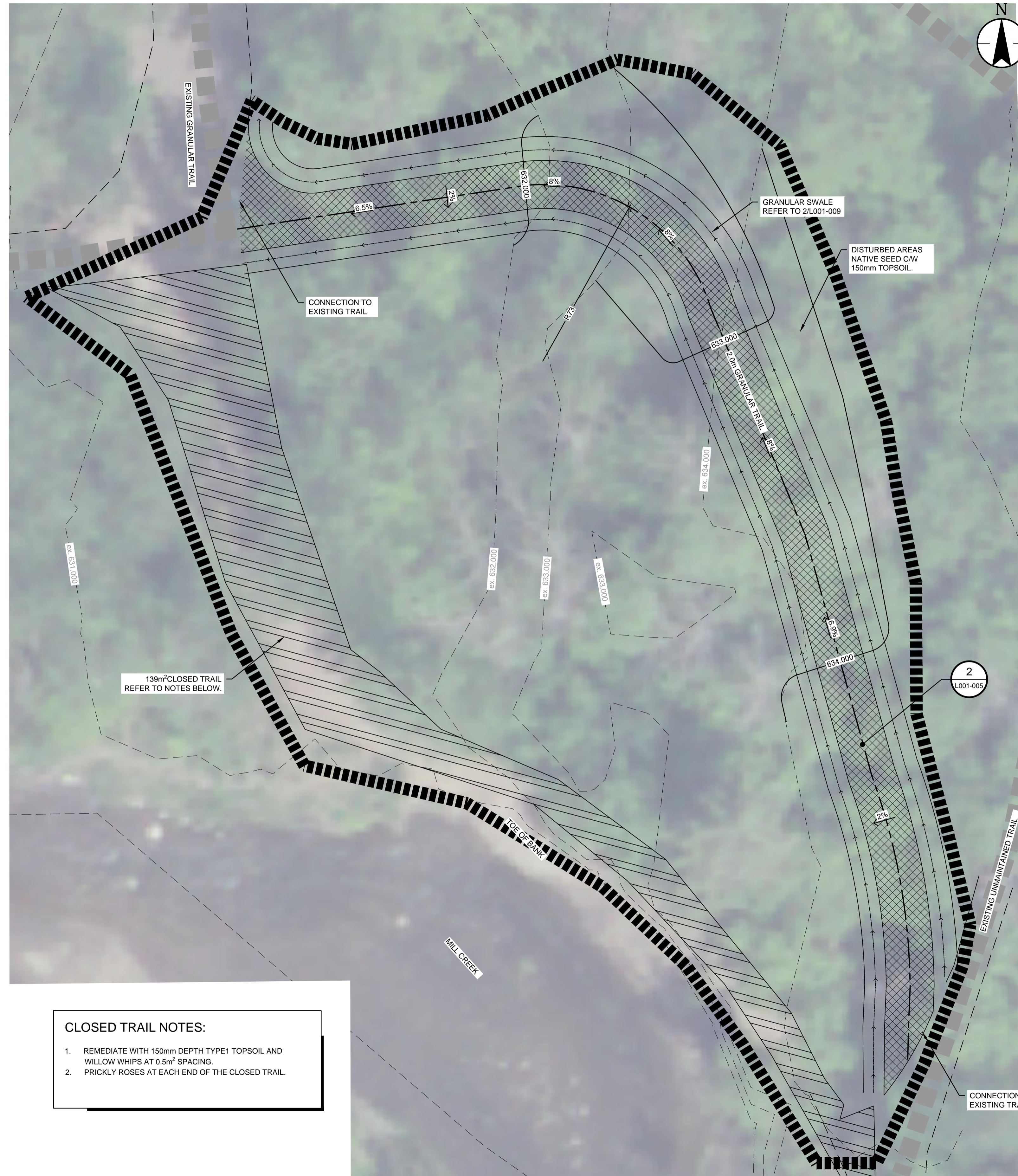

1 SITE #1 LAYOUT AND GRADING
SCALE: 1:100



Stantec Consulting Ltd.
10160 - 112 Street
Edmonton AB Canada
Tel. 780.917.7000
www.stantec.com

Copyright Reserved

The Contractor shall verify and be responsible for all dimensions. DO NOT scale the drawing - any errors or omissions shall be reported to Stantec without delay. The Copyrights to all designs and drawings are the property of Stantec. Reproduction or use for any purpose other than that authorized by Stantec is forbidden.

Legend

- EXISTING GRANULAR TRAIL
 - PROPOSED CONTOUR
 - EXISTING CONTOUR (MAJOR)
 - EXISTING CONTOUR (MINOR)
 - LIMIT OF CONSTRUCTION
- DETAIL REFERENCE SYMBOL
 1
 L001-001
 DETAIL NUMBER
 SHEET NUMBER

Notes

UTILITY SETBACKS

LANDSCAPE CONTRACTOR TO CALL 'ALBERTA ONE-CALL' AT 1-800-242-3447 TO HAVE ALL EXISTING SITE UTILITIES LOCATED PRIOR TO CONSTRUCTION AND PLANT NO CLOSER THAN THE FOLLOWING DIMENSIONS FROM THE SERVICES:

- 1.0 m FROM POWER LINES
- 3.5 m FROM ALL POWER HARDWARE
- 1.8 m FROM WATER MAINS, WATER VALVES, MANUAL AIRVENTS, AND SERVICES
- 2.0 m FROM SEWER MAINS, AND MANHOLES
- 1.8 m FROM SEWER SERVICES
- 1.5 m FROM GAS (NO TREES WITHIN EASEMENT)
- 7.5 m FROM STREET CORNERS.
- 3.5 m FROM FIRE HYDRANTS.
- 1.5 m FROM DRIVEWAYS
- 1.5 m FROM ALLEY ACCESSES
- 1.0 m FROM SIDEWALKS
- OR AS PER APPROVED ENG. CROSS SECTIONS
- 3.5 m FROM TRANSIT ZONES
- 3.0 m FROM PRIVATE PROPERTY BOUNDARY
- 1.25 m FROM COLLECTOR ROAD CURB FACE
- 1.25 m FROM LOCAL ROAD CURB FACE
- 2.0 m FROM ARTERIAL ROAD CURB FACE
- 3.5 m FROM YIELD AND STOP SIGNS
- 3.5 m FROM BUS STOP SIGNS
- 2.0 m FROM ALL OTHER SIGNS
- 1.0 m FROM OTHER UNDERGROUND UTILITIES
- 3.5 m FROM TELUS PEDESTALS
- 2.0 m FROM TELUS DUCT STRUCTURE
- 1.0 m FROM TELUS CABLE FACILITIES

LANDSCAPE CONTRACTOR IS RESPONSIBLE FOR DAMAGES AND LIABILITIES INCURRED BY DAMAGES TO SITE UTILITIES.

Development Engineer, Sustainable Development			
Approvals			YY.MM.DD
Revision			YY.MM.DD
	By	Appd.	
1. FIRST SUBMISSION (60%)	DW	NGS	18.05
Issued	By	Appd.	YY.MM
File Name: LA_MillCreek.dwg	DW	CB	NGS
	Dwn.	Chkd.	Dsgn.
			18.03.13
			YY.MM.DD

Permit-Seal



Client/Project
CITY OF EDMONTON

**MILL CREEK RAVINE PARK
TRAIL REHABILITATION**
Edmonton, Alberta

Title
SITE #1 LAYOUT AND GRADING

Project No. 1161106255 Scale 1:100

2018-12-05 3:32pm BY: DWIGLSEWORTH Drawing No. L001-002



KEY PLAN
SCALE: N.T.S.

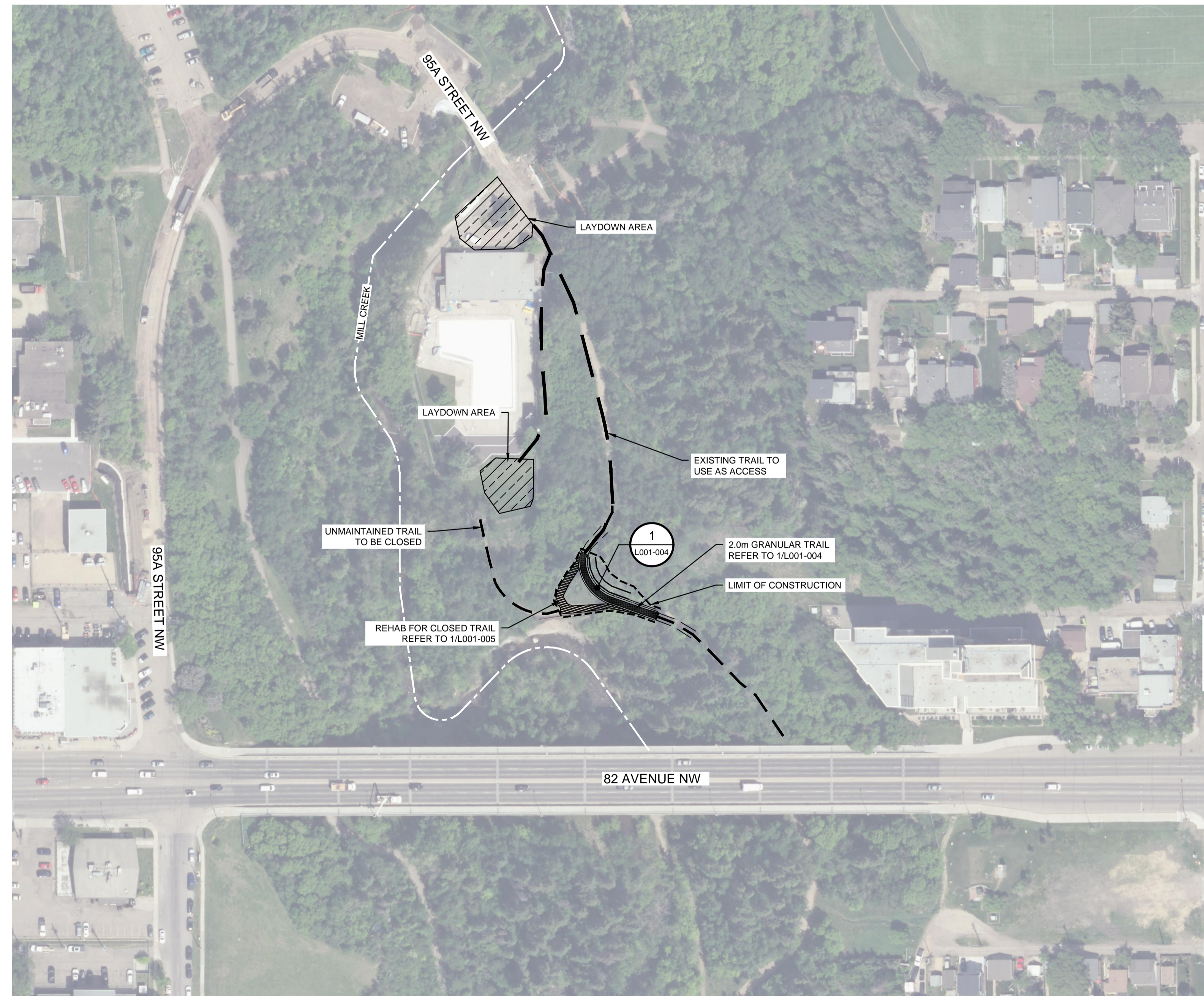

1 SITE #2 OVERALL PLAN
SCALE: 1:1000



Stantec Consulting Ltd.
10160 - 112 Street
Edmonton AB Canada
Tel. 780.917.7000
www.stantec.com

Copyright Reserved
The Contractor shall verify and be responsible for all dimensions. DO NOT scale the drawing - any errors or omissions shall be reported to Stantec without delay. The Copyrights to all designs and drawings are the property of Stantec. Reproduction or use for any purpose other than that authorized by Stantec is forbidden.

Legend

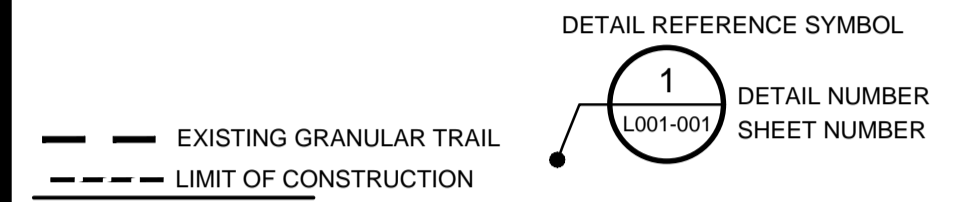

Notes
UTILITY SETBACKS
LANDSCAPE CONTRACTOR TO CALL 'ALBERTA ONE-CALL' AT 1-800-242-3447 TO HAVE ALL EXISTING SITE UTILITIES LOCATED PRIOR TO CONSTRUCTION AND PLANT NO CLOSER THAN THE FOLLOWING DIMENSIONS FROM THE SERVICES:

1. 1.0 m FROM POWER LINES
2. 3.5 m FROM ALL POWER HARDWARE
3. 1.8 m FROM WATER MAINS, WATER VALVES, MANUAL AIRVENTS, AND SERVICES
4. 2.0 m FROM SEWER MAINS, AND MANHOLES
5. 1.8 m FROM SEWER SERVICES
6. 1.5 m FROM GAS (NO TREES WITHIN EASEMENT)
7. 7.5 m FROM STREET CORNERS.
8. 3.5 m FROM FIRE HYDRANTS.
9. 1.5 m FROM DRIVEWAYS
10. 1.5 m FROM ALLEY ACCESSES
11. 1.0 m FROM SIDEWALKS
- OR AS PER APPROVED ENG. CROSS SECTIONS
12. 3.5 m FROM TRANSIT ZONES
13. 3.0 m FROM PRIVATE PROPERTY BOUNDARY
14. 1.25 m FROM COLLECTOR ROAD CURB FACE
15. 1.25 m FROM LOCAL ROAD CURB FACE
16. 2.0 m FROM ARTERIAL ROAD CURB FACE
17. 3.5 m FROM YIELD AND STOP SIGNS
18. 3.5 m FROM BUS STOP SIGNS
19. 2.0 m FROM ALL OTHER SIGNS
20. 1.0 m FROM OTHER UNDERGROUND UTILITIES
21. 3.5 m FROM TELUS PEDESTALS
22. 2.0 m FROM TELUS DUCT STRUCTURE
23. 1.0 m FROM TELUS CABLE FACILITIES

LANDSCAPE CONTRACTOR IS RESPONSIBLE FOR DAMAGES AND LIABILITIES INCURRED BY DAMAGES TO SITE UTILITIES.

Development Engineer, Sustainable Development			
Approvals			YY.MM.DD
Revision	By	Appd.	YY.MM.DD
1. FIRST SUBMISSION (60%)	DW	NGS	18.05
Issued	By	Appd.	YY.MM
File Name: LA_McCreek.dwg	DW	CB	NGS
	Dwn.	Chkd.	Dsgn.
			18.03.13
			YY.MM.DD

Permit-Seal



Natalie
Goulet-Sorenson

Client/Project
CITY OF EDMONTON

MILL CREEK RAVINE PARK
TRAIL REHABILITATION

Edmonton, Alberta

Title
SITE #2 OVERALL PLAN

Project No. 1161106255 Scale 1:1000

Drawing No. L001-003
2018-12-05 3:32pm BY: DWIGGLESWORTH 3 of 10



KEY PLAN
SCALE: N.T.S.

LAYOUT AND GRADING NOTES:

1. CONTRACTOR TO CALL ALBERTA ONE CALL AT 1-800-242-3447 TO HAVE EXISTING UTILITIES LOCATED PRIOR TO START OF ANY CONSTRUCTION.
2. THIS DRAWING IS TO BE READ IN CONJUNCTION WITH THE WRITTEN SPECIFICATIONS, DRAWINGS, AND DETAILS FOR THE PROJECT.
3. CONTRACTOR TO ENSURE THAT ALL NECESSARY ARRANGEMENTS ARE MADE WITH THE PIPELINE COMPANIES CONCERNING THE MOVEMENT OF MATERIALS AND EQUIPMENT NEAR ANY PIPELINE RIGHTS OF WAY.
4. CONTRACTOR IS RESPONSIBLE FOR THE HOARDING OF ALL TREES WITHIN OR ADJACENT TO CONSTRUCTION AREAS.
5. CONTRACTOR IS RESPONSIBLE FOR THE ADJUSTMENT OF ALL EXISTING CATCHBASINS, CATCHBASIN MANHOLES, MANHOLES, WATER VALVES, HYDRANTS, ETC. TO MATCH PROPOSED GRADES.
6. ENSURE POSITIVE DRAINAGE IN ALL SWALES AS SHOWN ON PLAN. DO NOT PERMIT POOLING OF WATER IN DRAINAGE SWALE.
7. CONTRACTOR IS RESPONSIBLE FOR HAULING OF ALL EXCESS MATERIALS OFF THE SITE.
8. CONTRACTOR IS RESPONSIBLE FOR GENERAL SITE CLEAN UP.
9. CONTRACTOR IS RESPONSIBLE FOR ANY DAMAGE TO LANDSCAPED AREAS AND MUST MAKE ALL NECESSARY RESTORATIONS AND REPAIRS.
10. ALL ANCILLARY WORK NORMALLY ASSOCIATED WITH THIS TYPE OF CONSTRUCTION SHALL BE DEEMED TO BE PART OF THE CONTRACT.
11. ALL QUANTITIES ARE APPROXIMATE ONLY.
12. GRADES TO BE APPROVED BY LANDSCAPE ARCHITECT PRIOR TO CONSTRUCTION STARTING.
13. CONTRACTOR TO HOLD ROUGH GRADES 450mm BELOW FINISHED GRADE FOR PLANT BEDS, 150mm FOR SEEDED AREAS, 200mm FOR WALKS, 100mm FOR SODDED AREAS.
14. STANDARD CONTOUR INTERVAL IS 500mm. SPOT ELEVATIONS AS SHOWN. ALL SPOT ELEVATIONS IN METERS. BERMS AND SLOPES TO BE GRADED SMOOTHLY. ELIMINATE ROUGH SPOTS AND LOW AREAS TO ENSURE POSITIVE DRAINAGE PRIOR TO SEEDING.
15. ALL PROPOSED GRADES TO MEET EXISTING GRADES AT PROPERTY LINE WITH A SMOOTH TRANSITION. LIMIT OF GRADING NOT TO EXTEND BEYOND PROPERTY LINE. GRADES TO MEET CURB OR WALK SMOOTHLY. LANDSCAPE ARCHITECT TO APPROVE ROUGH AND FINISHED GRADES.
16. MAXIMUM SLOPE OF ANY LANDSCAPED AREA NOT TO EXCEED 33%.
17. CONTRACTOR TO TAKE NECESSARY PRECAUTIONS TO PROTECT ALL SITE FEATURES EXISTING AT THE TIME OF CONSTRUCTION UNLESS SPECIFIED FOR DEMOLITION ON THE DRAWING. THIS INCLUDES ALL SURVEY BARS, STAKES OR MONUMENTS. MAKE GOOD ANY DAMAGE.
18. ANY AMBIGUITY IN THIS DRAWING OR ACCOMPANYING DETAILS IS TO BE REPORTED TO THE LANDSCAPE ARCHITECT FOR DIRECTION. CONTRACTOR NOT TO PROCEED IN UNCERTAINTY.
19. LIMITS OF WORK TO BE CLEARLY UNDERSTOOD BY THE CONTRACTOR PRIOR TO ANY WORK TAKING PLACE ON SITE. CONTRACTOR TO CONTACT LANDSCAPE ARCHITECT FOR CLARIFICATION IF REQUIRED.
20. CONTRACTOR TO VISIT SITE TO CONFIRM ALL SITE CONDITIONS PRIOR TO SUBMITTING BIDS. DISCREPANCIES TO BE REPORTED TO LANDSCAPE ARCHITECT FOR CLARIFICATION.
21. CONTRACTOR TO VERIFY ALL DIMENSIONS AND REPORT ANY DISCREPANCIES TO THE LANDSCAPE ARCHITECT.
22. LAYOUT TO BE APPROVED BY LANDSCAPE ARCHITECT PRIOR TO CONSTRUCTION STARTING.
23. ALL MEASUREMENTS ARE IN METERS UNLESS OTHERWISE NOTED.
24. CONTRACTOR SHALL SUPPLY ALL MATERIALS IN QUANTITIES SUFFICIENT TO COMPLETE WORK SHOWN ON THESE DRAWINGS. ANY DISCREPANCIES SHALL BE REPORTED TO THE LANDSCAPE ARCHITECT FOR DIRECTION.
25. NO SUBSTITUTIONS OF MATERIALS, PRODUCTS OR QUANTITIES WITHOUT PRIOR CONSENT OF LANDSCAPE ARCHITECT.

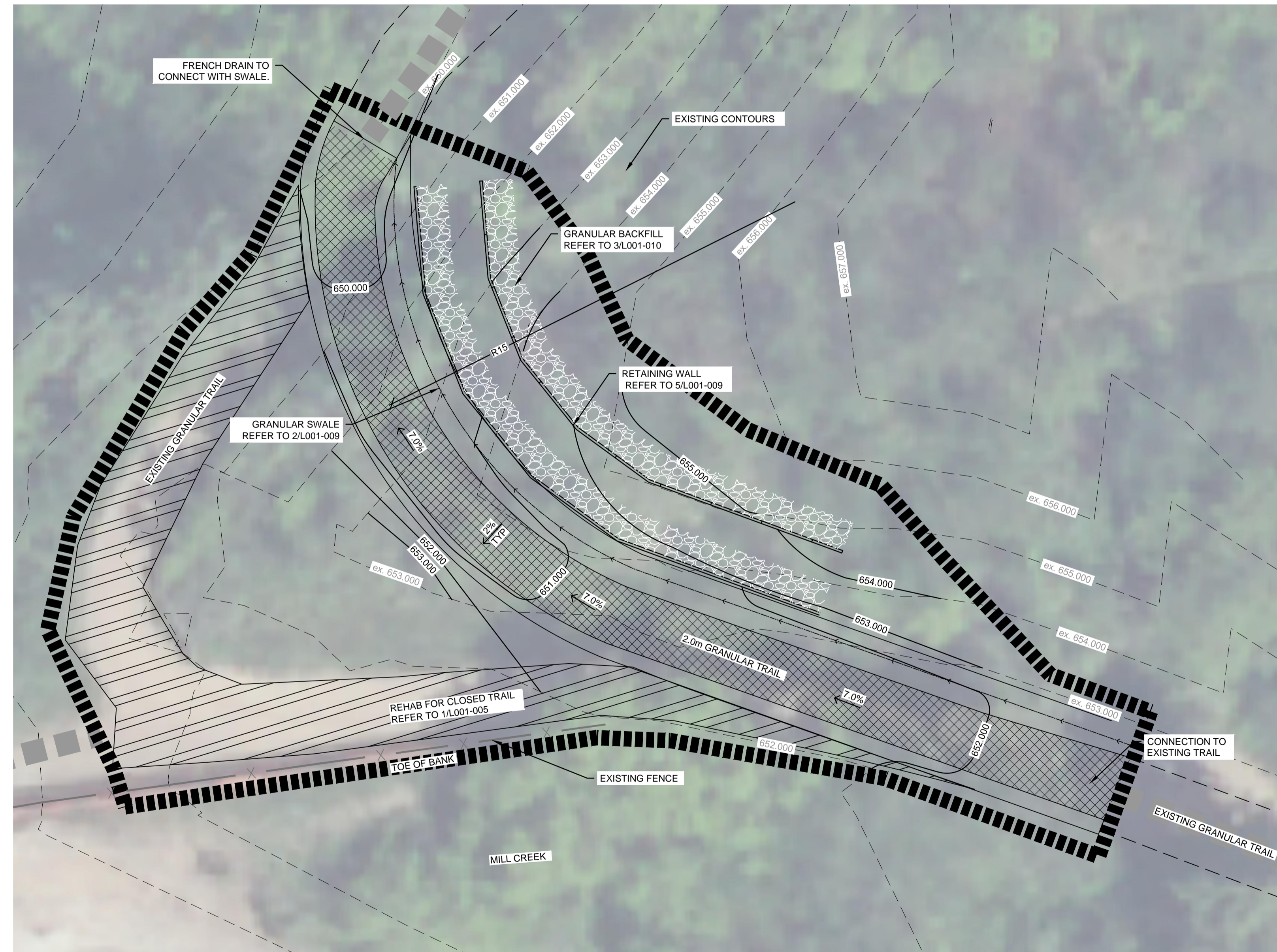

1 SITE #2 GRADING AND LAYOUT
SCALE: 1:100



Stantec Consulting Ltd.
10160 - 112 Street
Edmonton AB Canada
Tel. 780.917.7000
www.stantec.com

Copyright Reserved

The Contractor shall verify and be responsible for all dimensions. DO NOT scale the drawing - any errors or omissions shall be reported to Stantec without delay. The Copyrights to all designs and drawings are the property of Stantec. Reproduction or use for any purpose other than that authorized by Stantec is forbidden.

Legend

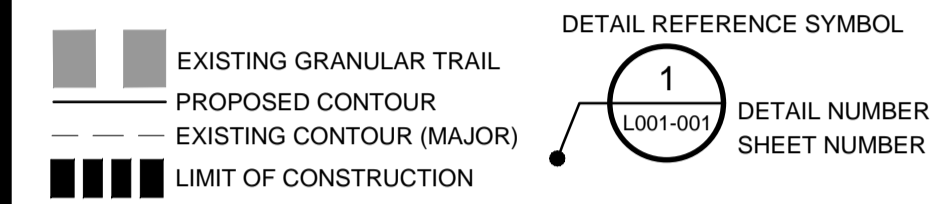

Notes

UTILITY SETBACKS

LANDSCAPE CONTRACTOR TO CALL 'ALBERTA ONE-CALL' AT 1-800-242-3447 TO HAVE ALL EXISTING SITE UTILITIES LOCATED PRIOR TO CONSTRUCTION AND PLANT NO CLOSER THAN THE FOLLOWING DIMENSIONS FROM THE SERVICES:

1. 1.0 m FROM POWER LINES
2. 3.5 m FROM ALL POWER HARDWARE
3. 1.8 m FROM WATER MAINS, WATER VALVES, MANUAL AIRVENTS, AND SERVICES
4. 2.0 m FROM SEWER MAINS, AND MANHOLES
5. 1.8 m FROM SEWER SERVICES
6. 1.5 m FROM GAS (NO TREES WITHIN EASEMENT)
7. 7.5 m FROM STREET CORNERS.
8. 3.5 m FROM FIRE HYDRANTS.
9. 1.5 m FROM DRIVEWAYS
10. 1.5 m FROM ALLEY ACCESSES
11. 1.0 m FROM SIDEWALKS
- OR AS PER APPROVED ENG. CROSS SECTIONS
12. 3.5 m FROM TRANSIT ZONES
13. 3.0 m FROM PRIVATE PROPERTY BOUNDARY
14. 1.25 m FROM COLLECTOR ROAD CURB FACE
15. 1.25 m FROM LOCAL ROAD CURB FACE
16. 2.0 m FROM ARTERIAL ROAD CURB FACE
17. 3.5 m FROM YIELD AND STOP SIGNS
18. 3.5 m FROM BUS STOP SIGNS
19. 2.0 m FROM ALL OTHER SIGNS
20. 1.0 m FROM OTHER UNDERGROUND UTILITIES
21. 3.5 m FROM TELUS PEDESTALS
22. 2.0 m FROM TELUS DUCT STRUCTURE
23. 1.0 m FROM TELUS CABLE FACILITIES

LANDSCAPE CONTRACTOR IS RESPONSIBLE FOR DAMAGES AND LIABILITIES INCURRED BY DAMAGES TO SITE UTILITIES.

Development Engineer, Sustainable Development			
Approvals			YY.MM.DD
Revision	By	Appd.	YY.MM.DD
1: FIRST SUBMISSION (60%)	DW	NGS	18.05
Issued	By	Appd.	YY.MM
File Name: LA_MillCreek.dwg	DW	CB	NGS
	Dwn.	Chkd.	Dsgn.
			18.03.13
			YY.MM.DD

Permit-Seal



Natalie
Goulet-Sorenson

Client/Project

CITY OF EDMONTON

MILL CREEK ZAVINE PARK
TRAIL REHABILITATION

Edmonton, Alberta

Title

SITE #2 LAYOUT AND GRADING

Project No.

1161106255

Scale

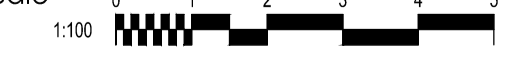

V:\1161\active\1161106255\drawing_Landscape\LA_MillCreek.dwg

2018-12-05 3:32pm BY: DWIGGLESWORTH

Drawing No.

L001-004

4 of 10



KEY PLAN
SCALE: N.T.S.

PLANT MATERIAL LIST: (THIS SHEET ONLY)

QTY./SYM. BOTANICAL/COMMON NAME SIZE CONDITION

DECIDUOUS SHRUBS

(36) raa	<i>Rosa acicularis</i> PRICKLY ROSE	450 mm HT. MIN. #6 CONTAINER	CONTAINER GROWN, OR BALLED & BURLAPPED 4 CANES OR MORE 400mm HT. WITH MIN ROOT SPREAD 250mm.
-------------	--	---------------------------------	--

NOTE: ALL TREES TO BE HIGH HEADED AND EXHIBIT A FULL AND UNIFORM CROWN, WITH A SINGLE, DOMINANT, WELL DEVELOPED LEADER; TREES WITH BROKEN OR DAMAGED OR MISSING LEADERS WILL NOT BE ACCEPTED. ALL PLANT MATERIAL MUST CONFORM TO THE CITY OF EDMONTON DESIGN AND CONSTRUCTION STANDARDS.

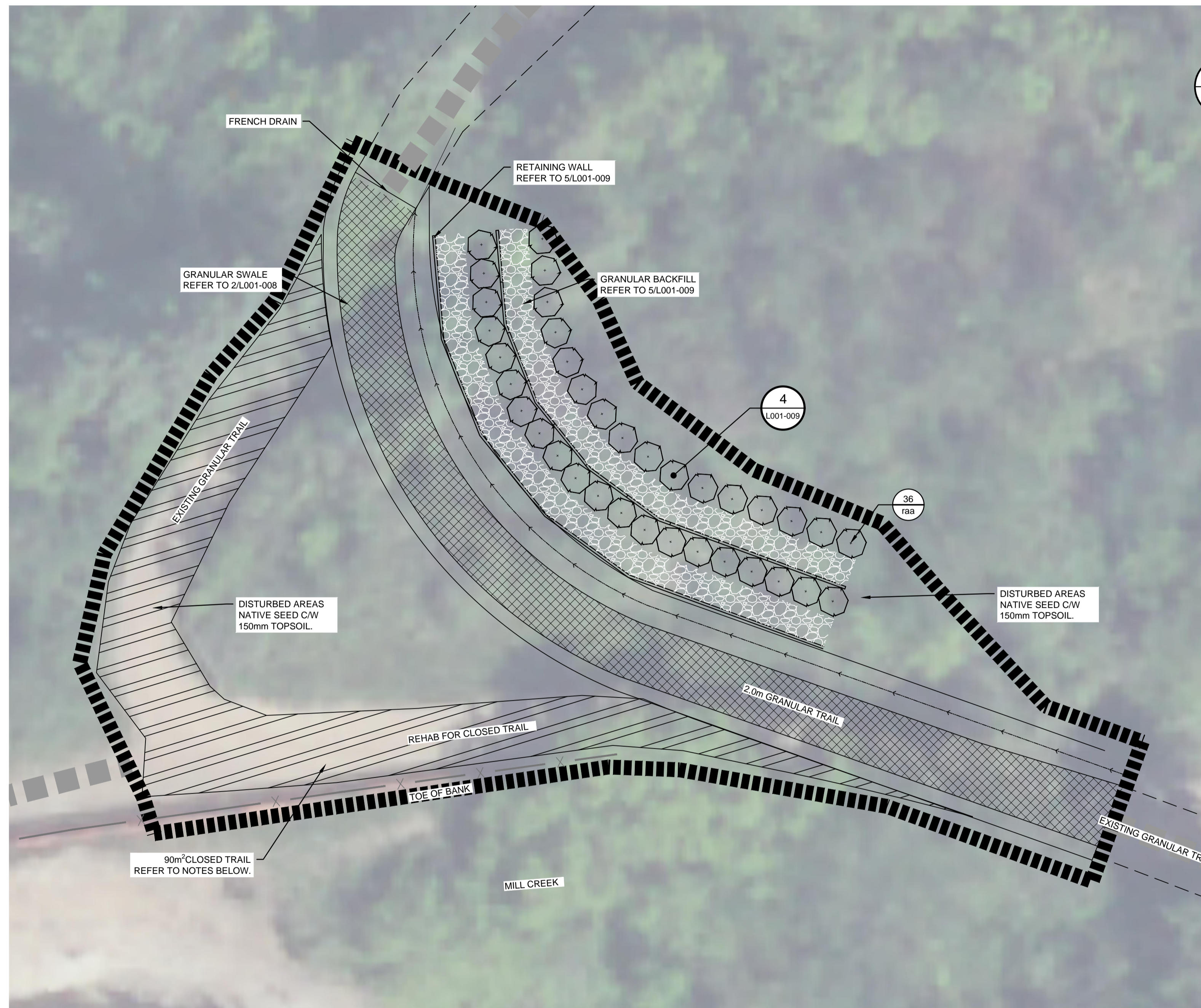

1 SITE #2 PLANTING PLAN
SCALE: 1;100

CLOSED TRAIL NOTES:

1. REMEDIATE WITH 150mm DEPTH TYPE1 TOPSOIL AND WILLOW WHIPS AT 0.5m² SPACING.
2. PRICKLY ROSES AT EACH END OF THE CLOSED TRAIL.

NATIVE SEED MIX

CERTIFIED CANADA NO. 1 MIXTURE, MINIMUM GERMINATION OF 75%, MINIMUM PURITY OF 97%. ALL SEED MUST BE FROM A RECOGNIZED SEED FARM, MEETING THE REQUIREMENTS FOR THE SEEDS ACT FOR CANADA NO. 1 SEED. SEED SHALL BE CERTIFIED NO. 1 GRADE. A GERMINATION TEST MAY BE REQUESTED AND ALL LAWN SEED MUST COMPLY WITH FEDERAL AND PROVINCIAL SEED LAWS.

FOR NON-MAINTAINED NATIVE LANDSCAPING:

- 15% AWNED WHEATGRASS (AGROPYRON TRACHYCAULUM VAR. UNILATERALE)
- 15% SLENDER WHEATGRASS (AGROPYRON TRACHYCAULUM VAR. TRACHYCAULUM)
- 15% WESTERN WHEAT (AGROPYRON SMITHII)
- 5% SLOUGHGRASS (BECKMANNIA SYZIGACHNE)
- 5% IDAHO FESCUE (FESTUCA IDAHOENSIS)
- 5% ALKALI BLUEGRASS (POA SECUNDA SSP. JUNCIFOLIA)
- 5% JUNEGRASS (KOELERIA MACRANTHA)
- 5% SANDBERG BLUEGRASS (POA SECUNDA)
- 20% GREEN NEEDLEGRASS (STIPA VIRIDULA)
- 10% ROCKY MOUNTAIN FESCUE (FESTUCA SAXIMONTANA)

SEED RATE: 250KG PER HECTARE

PLANTING NOTES:

1. CONTRACTOR TO CALL ALBERTA ONE CALL AT 1-800- 242-3447 TO HAVE EXISTING UTILITIES LOCATED PRIOR TO START OF ANY CONSTRUCTION.
2. CONTRACTOR TO ENSURE THAT ALL NECESSARY ARRANGEMENTS ARE MADE WITH THE PIPELINE COMPANIES CONCERNING THE MOVEMENT OF MATERIALS AND EQUIPMENT NEAR ANY PIPELINE RIGHTS OF WAY.
3. CONTRACTOR IS RESPONSIBLE FOR THE HOARDING OF ALL TREES WITHIN OR ADJACENT TO CONSTRUCTION AREAS.
4. CONTRACTOR IS RESPONSIBLE FOR THE ADJUSTMENT OF ALL EXISTING CATCHBASINS, CATCHBASIN MANHOLES, MANHOLES, WATER VALVES, HYDRANTS, ETC. TO MATCH PROPOSED GRADES.
5. CONTRACTOR TO SUPPLY AND INSTALL 12mm FIBRE MASTIC JOINT WHENEVER MATCHING TO OR ABUTTING TO ANY CONCRETE OR BLDG.
6. CONTRACTOR IS RESPONSIBLE FOR HAULING OF ALL EXCESS MATERIALS OFF THE SITE.
7. CONTRACTOR IS RESPONSIBLE FOR GENERAL SITE CLEAN UP.
8. CONTRACTOR IS RESPONSIBLE FOR ANY DAMAGE TO LANDSCAPED AREAS AND MUST MAKE ALL NECESSARY RESTORATIONS AND REPAIRS.
9. ALL ANCILLARY WORK NORMALLY ASSOCIATED WITH THIS TYPE OF CONSTRUCTION SHALL BE DEEMED TO BE PART OF THE CONTRACT.
10. CONTRACTOR TO VERIFY ALL DIMENSIONS AND REPORT ANY DISCREPANCIES TO THE LANDSCAPE ARCHITECT.
11. LAYOUT TO BE APPROVED BY LANDSCAPE ARCHITECT PRIOR TO CONSTRUCTION STARTING.
12. ALL MEASUREMENTS ARE IN METERS UNLESS OTHERWISE NOTED.
13. CONTRACTOR TO OBTAIN APPROVAL FOR PLANT MATERIAL LAYOUT.
14. ALL PLANT MATERIAL TO BE NURSERY GROWN STOCK AND SHALL MEET OR EXCEED THE SPECIFICATIONS OF THE CANADIAN NURSERY TRADES ASSOC. FOR SIZE, HEIGHT, SPREAD, GRADING, QUALITY, AND METHOD OF CULTIVATION.
15. NO SUBSTITUTIONS OF MATERIALS, PRODUCTS OR QUANTITIES WITHOUT PRIOR CONSENT OF LANDSCAPE ARCHITECT.
16. ALL PLANT MATERIAL AND WORKMANSHIP TO CONFORM TO THE REQUIREMENTS OF THE CITY OF EDMONTON DESIGN AND CONSTRUCTION STANDARDS IN ITS MOST RECENT EDITION.
17. CONTRACTOR TO CONTACT A CITY OF EDMONTON FORESTRY REPRESENTATIVE A MINIMUM OF FIVE (5) DAYS PRIOR TO THE CONSTRUCTION OF THE CORED BOULEVARDS.



Stantec Consulting Ltd.
10160 - 112 Street
Edmonton AB Canada
Tel. 780.917.7000
www.stantec.com

Copyright Reserved

The Contractor shall verify and be responsible for all dimensions. DO NOT scale the drawing - any errors or omissions shall be reported to Stantec without delay. The Copyrights to all designs and drawings are the property of Stantec. Reproduction or use for any purpose other than that authorized by Stantec is forbidden.

Legend

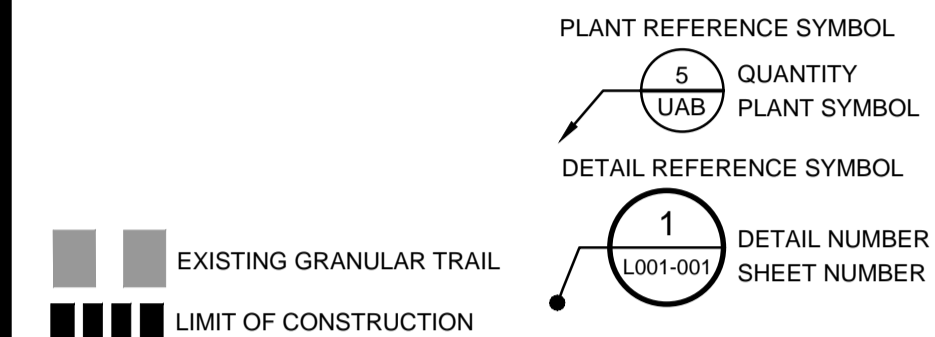

Notes

UTILITY SETBACKS

LANDSCAPE CONTRACTOR TO CALL 'ALBERTA ONE-CALL' AT 1-800-242-3447 TO HAVE ALL EXISTING SITE UTILITIES LOCATED PRIOR TO CONSTRUCTION AND PLANT NO CLOSER THAN THE FOLLOWING DIMENSIONS FROM THE SERVICES:

1. 1.0 m FROM POWER LINES
2. 3.5 m FROM ALL POWER HARDWARE
3. 1.8 m FROM WATER MAINS, WATER VALVES, MANUAL AIRVENTS, AND SERVICES
4. 2.0 m FROM SEWER MAINS, AND MANHOLES
5. 1.8 m FROM SEWER SERVICES
6. 1.5 m FROM GAS (NO TREES WITHIN EASEMENT)
7. 7.5 m FROM STREET CORNERS.
8. 3.5 m FROM FIRE HYDRANTS.
9. 1.5 m FROM DRIVEWAYS
10. 1.5 m FROM ALLEY ACCESSES
11. 1.0 m FROM SIDEWALKS
- OR AS PER APPROVED ENG. CROSS SECTIONS
12. 3.5 m FROM TRANSIT ZONES
13. 3.0 m FROM PRIVATE PROPERTY BOUNDARY
14. 1.25 m FROM COLLECTOR ROAD CURB FACE
15. 1.25 m FROM LOCAL ROAD CURB FACE
16. 2.0 m FROM ARTERIAL ROAD CURB FACE
17. 3.5 m FROM YIELD AND STOP SIGNS
18. 3.5 m FROM BUS STOP SIGNS
19. 2.0 m FROM ALL OTHER SIGNS
20. 1.0 m FROM OTHER UNDERGROUND UTILITIES
21. 3.5 m FROM TELUS PEDESTALS
22. 2.0 m FROM TELUS DUCT STRUCTURE
23. 1.0 m FROM TELUS CABLE FACILITIES

LANDSCAPE CONTRACTOR IS RESPONSIBLE FOR DAMAGES AND LIABILITIES INCURRED BY DAMAGES TO SITE UTILITIES.

Development Engineer, Sustainable Development			
Approvals			YY.MM.DD
Revision	By	Appd.	YY.MM.DD
1. FIRST SUBMISSION (60%)	DW	NGS	18.05
Issued	By	Appd.	YY.MM
File Name: LA_MMCreek.dwg	DW	CB	NGS
	Dwn.	Chkd.	Dsgn.
			18.03.13
			YY.MM.DD

Permit-Seal



Natalie
Goulet-Sorenson

Client/Project

CITY OF EDMONTON

MILL CREEK RAVINE PARK
TRAIL REHABILITATION

Edmonton, Alberta

Title

SITE #2 PLANTING PLAN

Project No.

1161106255

Scale



V:\1161\active\1161106255\drawing_Landscape\LA_MMCreek.dwg

2018-12-05 3:32pm BY: DWIGLSEWORTH

Drawing No.

L001-005



KEY PLAN
SCALE: N.T.S.



1 SITE #3 OVERALL PLAN
SCALE: 1:1000



Stantec Consulting Ltd.
10160 - 112 Street
Edmonton AB Canada
Tel. 780.917.7000
www.stantec.com

Copyright Reserved
The Contractor shall verify and be responsible for all dimensions. DO NOT scale the drawing - any errors or omissions shall be reported to Stantec without delay. The Copyrights to all designs and drawings are the property of Stantec. Reproduction or use for any purpose other than that authorized by Stantec is forbidden.

Legend

---	EXISTING GRANULAR TRAIL
---	LIMIT OF CONSTRUCTION

Notes

UTILITY SETBACKS
LANDSCAPE CONTRACTOR TO CALL 'ALBERTA ONE-CALL' AT 1-800-242-3447 TO HAVE ALL EXISTING SITE UTILITIES LOCATED PRIOR TO CONSTRUCTION AND PLANT NO CLOSER THAN THE FOLLOWING DIMENSIONS FROM THE SERVICES:

1. 1.0 m FROM POWER LINES
2. 3.5 m FROM ALL POWER HARDWARE
3. 1.8 m FROM WATER MAINS, WATER VALVES, MANUAL AIRVENTS, AND SERVICES
4. 2.0 m FROM SEWER MAINS, AND MANHOLES
5. 1.8 m FROM SEWER SERVICES
6. 1.5 m FROM GAS (NO TREES WITHIN EASEMENT)
7. 7.5 m FROM STREET CORNERS.
8. 3.5 m FROM FIRE HYDRANTS.
9. 1.5 m FROM DRIVEWAYS
10. 1.5 m FROM ALLEY ACCESSES
11. 1.0 m FROM SIDEWALKS
- OR AS PER APPROVED ENG. CROSS SECTIONS
12. 3.5 m FROM TRANSIT ZONES
13. 3.0 m FROM PRIVATE PROPERTY BOUNDARY
14. 1.25 m FROM COLLECTOR ROAD CURB FACE
15. 1.25 m FROM LOCAL ROAD CURB FACE
16. 2.0 m FROM ARTERIAL ROAD CURB FACE
17. 3.5 m FROM YIELD AND STOP SIGNS
18. 3.5 m FROM BUS STOP SIGNS
19. 2.0 m FROM ALL OTHER SIGNS
20. 1.0 m FROM OTHER UNDERGROUND UTILITIES
21. 3.5 m FROM TELUS PEDESTALS
22. 2.0 m FROM TELUS DUCT STRUCTURE
23. 1.0 m FROM TELUS CABLE FACILITIES

LANDSCAPE CONTRACTOR IS RESPONSIBLE FOR DAMAGES AND LIABILITIES INCURRED BY DAMAGES TO SITE UTILITIES.

Development Engineer, Sustainable Development			
Approvals			YY.MM.DD
Revision	By	Appd.	YY.MM.DD
1. FIRST SUBMISSION (60%)	DW	NGS	18.05
Issued	By	Appd.	YY.MM
File Name: LA_McCreek.dwg	DW	CB	NGS
	Dwn.	Chkd.	Dsgn.
			18.03.13
			YY.MM.DD

Permit-Seal



Natalie
Goulet-Sorenson

Client/Project

CITY OF EDMONTON

MILL CREEK RAVINE PARK
TRAIL REHABILITATION

Edmonton, Alberta

Title

SITE #3 OVERALL PLAN

Project No.

1161106255

Scale

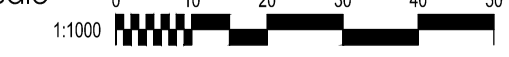

V:\1161\active\1161106255\drawing_Landscape\LA_McCreek.dwg

2018-12-05 3:32pm BY: DWIGGLESWORTH

6 of 10

Drawing No.

L001-006



KEY PLAN
SCALE: N.T.S.

LAYOUT AND GRADING NOTES:

- CONTRACTOR TO CALL ALBERTA ONE CALL AT 1-800-242-3447 TO HAVE EXISTING UTILITIES LOCATED PRIOR TO START OF ANY CONSTRUCTION.
- THIS DRAWING IS TO BE READ IN CONJUNCTION WITH THE WRITTEN SPECIFICATIONS, DRAWINGS, AND DETAILS FOR THE PROJECT.
- CONTRACTOR TO ENSURE THAT ALL NECESSARY ARRANGEMENTS ARE MADE WITH THE PIPELINE COMPANIES CONCERNING THE MOVEMENT OF MATERIALS AND EQUIPMENT NEAR ANY PIPELINE RIGHTS OF WAY.
- CONTRACTOR IS RESPONSIBLE FOR THE HOARDING OF ALL TREES WITHIN OR ADJACENT TO CONSTRUCTION AREAS.
- CONTRACTOR IS RESPONSIBLE FOR THE ADJUSTMENT OF ALL EXISTING CATCHBASINS, CATCHBASIN MANHOLES, MANHOLES, WATER VALVES, HYDRANTS, ETC. TO MATCH PROPOSED GRADES.
- ENSURE POSITIVE DRAINAGE IN ALL SWALES AS SHOWN ON PLAN. DO NOT PERMIT POOLING OF WATER IN DRAINAGE SWALE.
- CONTRACTOR IS RESPONSIBLE FOR HAULING OF ALL EXCESS MATERIALS OFF THE SITE.
- CONTRACTOR IS RESPONSIBLE FOR GENERAL SITE CLEAN UP.
- CONTRACTOR IS RESPONSIBLE FOR ANY DAMAGE TO LANDSCAPED AREAS AND MUST MAKE ALL NECESSARY RESTORATIONS AND REPAIRS.
- ALL ANCILLARY WORK NORMALLY ASSOCIATED WITH THIS TYPE OF CONSTRUCTION SHALL BE DEEMED TO BE PART OF THE CONTRACT.
- ALL QUANTITIES ARE APPROXIMATE ONLY.
- GRADES TO BE APPROVED BY LANDSCAPE ARCHITECT PRIOR TO CONSTRUCTION STARTING.
- CONTRACTOR TO HOLD ROUGH GRADES 450mm BELOW FINISHED GRADE FOR PLANT BEDS, 150mm FOR SEEDED AREAS, 200mm FOR WALKS, 100mm FOR SODDED AREAS.
- STANDARD CONTOUR INTERVAL IS 500mm. SPOT ELEVATIONS AS SHOWN. ALL SPOT ELEVATIONS IN METERS. BERMS AND SLOPES TO BE GRADED SMOOTHLY. ELIMINATE ROUGH SPOTS AND LOW AREAS TO ENSURE POSITIVE DRAINAGE PRIOR TO SEEDING.
- ALL PROPOSED GRADES TO MEET EXISTING GRADES AT PROPERTY LINE WITH A SMOOTH TRANSITION. LIMIT OF GRADING NOT TO EXTEND BEYOND PROPERTY LINE. GRADES TO MEET CURB OR WALK SMOOTHLY. LANDSCAPE ARCHITECT TO APPROVE ROUGH AND FINISHED GRADES.
- MAXIMUM SLOPE OF ANY LANDSCAPED AREA NOT TO EXCEED 33%.
- CONTRACTOR TO TAKE NECESSARY PRECAUTIONS TO PROTECT ALL SITE FEATURES EXISTING AT THE TIME OF CONSTRUCTION UNLESS SPECIFIED FOR DEMOLITION ON THE DRAWING. THIS INCLUDES ALL SURVEY BARS, STAKES OR MONUMENTS. MAKE GOOD ANY DAMAGE.
- ANY AMBIGUITY IN THIS DRAWING OR ACCOMPANYING DETAILS IS TO BE REPORTED TO THE LANDSCAPE ARCHITECT FOR DIRECTION. CONTRACTOR NOT TO PROCEED IN UNCERTAINTY.
- LIMITS OF WORK TO BE CLEARLY UNDERSTOOD BY THE CONTRACTOR PRIOR TO ANY WORK TAKING PLACE ON SITE. CONTRACTOR TO CONTACT LANDSCAPE ARCHITECT FOR CLARIFICATION IF REQUIRED.
- CONTRACTOR TO VISIT SITE TO CONFIRM ALL SITE CONDITIONS PRIOR TO SUBMITTING BIDS. DISCREPANCIES TO BE REPORTED TO LANDSCAPE ARCHITECT FOR CLARIFICATION.
- CONTRACTOR TO VERIFY ALL DIMENSIONS AND REPORT ANY DISCREPANCIES TO THE LANDSCAPE ARCHITECT.
- LAYOUT TO BE APPROVED BY LANDSCAPE ARCHITECT PRIOR TO CONSTRUCTION STARTING.
- ALL MEASUREMENTS ARE IN METERS UNLESS OTHERWISE NOTED.
- CONTRACTOR SHALL SUPPLY ALL MATERIALS IN QUANTITIES SUFFICIENT TO COMPLETE WORK SHOWN ON THESE DRAWINGS. ANY DISCREPANCIES SHALL BE REPORTED TO THE LANDSCAPE ARCHITECT FOR DIRECTION.
- NO SUBSTITUTIONS OF MATERIALS, PRODUCTS OR QUANTITIES WITHOUT PRIOR CONSENT OF LANDSCAPE ARCHITECT.

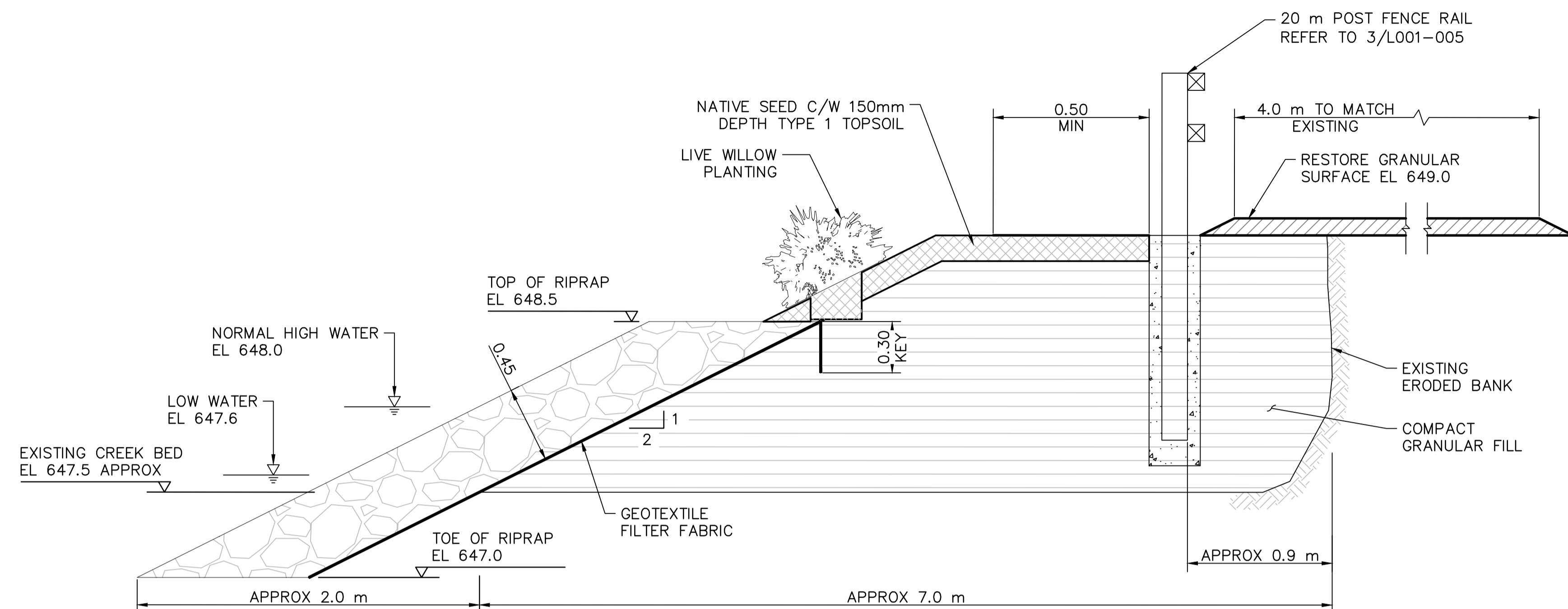

A STIE #3 SECTION
SCALE: 1:20

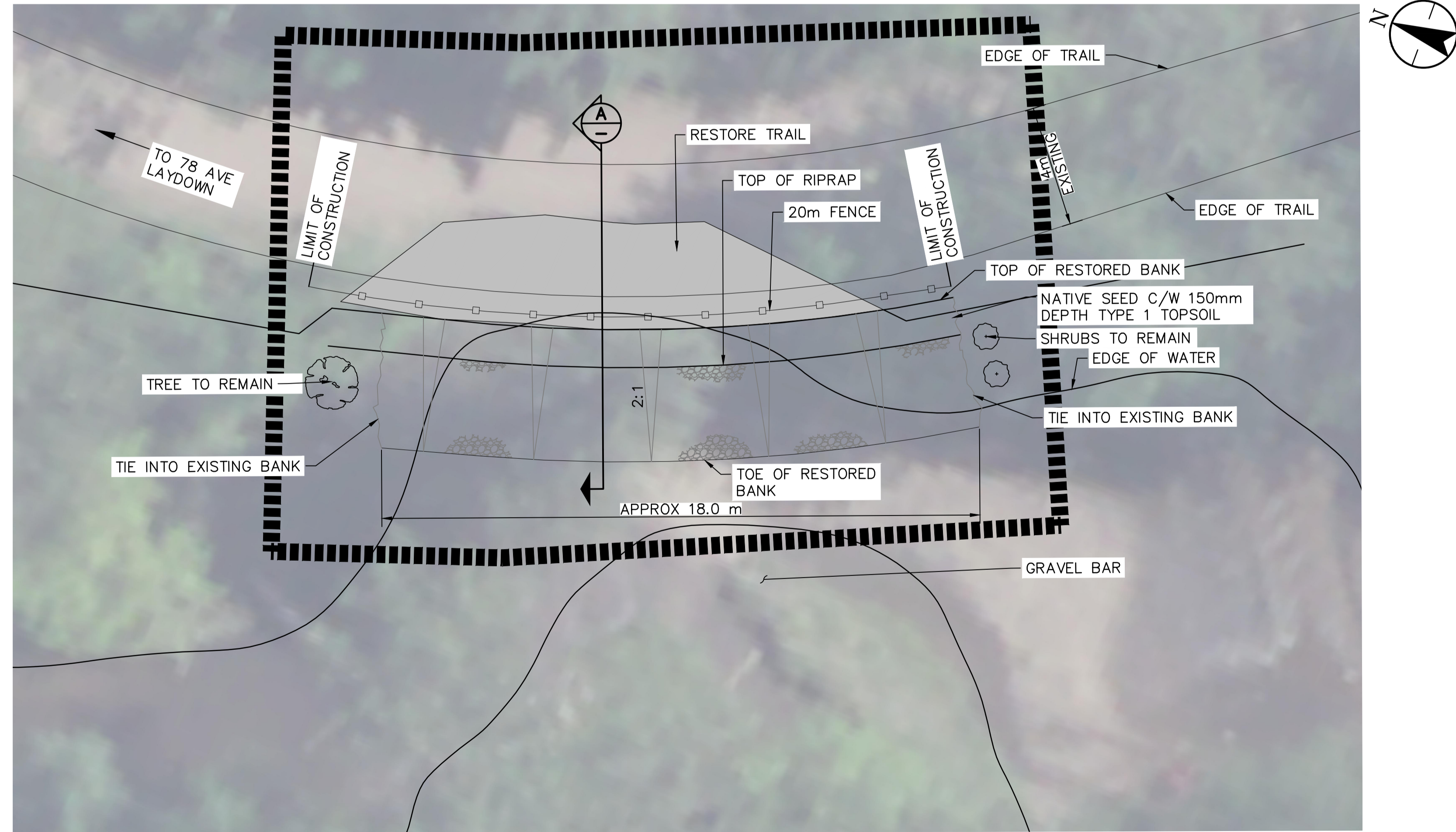

1 SITE #3 GRADING AND LAYOUT
SCALE: 1:100



Stantec Consulting Ltd.
10160 - 112 Street
Edmonton AB Canada
Tel. 780.917.7000
www.stantec.com

Copyright Reserved
The Contractor shall verify and be responsible for all dimensions. DO NOT scale the drawing - any errors or omissions shall be reported to Stantec without delay. The Copyrights to all designs and drawings are the property of Stantec. Reproduction or use for any purpose other than that authorized by Stantec is forbidden.

Legend

	POST AND RAIL FENCING
	EXISTING GRANULAR TRAIL
	PROPOSED CONTOUR
	EXISTING CONTOUR (MAJOR)
	EXISTING CONTOUR (MINOR)
	LIMIT OF CONSTRUCTION

Notes

UTILITY SETBACKS
LANDSCAPE CONTRACTOR TO CALL 'ALBERTA ONE-CALL' AT 1-800-242-3447 TO HAVE ALL EXISTING SITE UTILITIES LOCATED PRIOR TO CONSTRUCTION AND PLANT NO CLOSER THAN THE FOLLOWING DIMENSIONS FROM THE SERVICES:

- 1.0 m FROM POWER LINES
- 3.5 m FROM ALL POWER HARDWARE
- 1.8 m FROM WATER MAINS, WATER VALVES, MANUAL AIRVENTS, AND SERVICES
- 2.0 m FROM SEWER MAINS, AND MANHOLES
- 1.8 m FROM SEWER SERVICES
- 1.5 m FROM GAS (NO TREES WITHIN EASEMENT)
- 7.5 m FROM STREET CORNERS.
- 3.5 m FROM FIRE HYDRANTS.
- 1.5 m FROM DRIVEWAYS
- 1.5 m FROM ALLEY ACCESSES
- 1.0 m FROM SIDEWALKS

OR AS PER APPROVED ENG. CROSS SECTIONS

- 3.5 m FROM TRANSIT ZONES
- 3.0 m FROM PRIVATE PROPERTY BOUNDARY
- 1.25 m FROM COLLECTOR ROAD CURB FACE
- 1.25 m FROM LOCAL ROAD CURB FACE
- 2.0 m FROM ARTERIAL ROAD CURB FACE
- 3.5 m FROM YIELD AND STOP SIGNS
- 3.5 m FROM BUS STOP SIGNS
- 2.0 m FROM ALL OTHER SIGNS
- 1.0 m FROM OTHER UNDERGROUND UTILITIES
- 3.5 m FROM TELUS PEDESTALS
- 2.0 m FROM TELUS DUCT STRUCTURE
- 1.0 m FROM TELUS CABLE FACILITIES

LANDSCAPE CONTRACTOR IS RESPONSIBLE FOR DAMAGES AND LIABILITIES INCURRED BY DAMAGES TO SITE UTILITIES.

Development Engineer, Sustainable Development			
Approvals			YY.MM.DD
Revision	By	Appd.	YY.MM.DD
1: FIRST SUBMISSION (60%)	DW	NGS	18.05
Issued	By	Appd.	YY.MM
File Name: LA_MMCreek.dwg	DW	CB	NGS
	Dwn.	Chkd.	Dsgn.
			18.03.13
			YY.MM.DD

Permit-Seal

Natalie
Goulet-Sorenson

Client/Project
CITY OF EDMONTON

MILL CREEK RAVINE PARK
TRAIL REHABILITATION
Edmonton, Alberta

Title
SITE #3 GRADING AND LAYOUT

Project No. 1161106255 Scale 1:100

Drawing No. L001-007
2018-12-05 3:32pm BY: DWIGLESWORTH 7 of 10



KEY PLAN
SCALE: N.T.S.

NATIVE SEED MIX

CERTIFIED CANADA NO. 1 MIXTURE, MINIMUM GERMINATION OF 75%, MINIMUM PURITY OF 97%. ALL SEED MUST BE FROM A RECOGNIZED SEED FARM, MEETING THE REQUIREMENTS FOR THE SEEDS ACT FOR CANADA NO. 1 SEED. SEED SHALL BE CERTIFIED NO. 1 GRADE. A GERMINATION TEST MAY BE REQUESTED AND ALL LAWN SEED MUST COMPLY WITH FEDERAL AND PROVINCIAL SEED LAWS.

FOR NON-MAINTAINED NATIVE LANDSCAPING:

- 15% AWNED WHEATGRASS (AGROPYRON TRACHYCAULUM VAR. UNILATERALE)
- 15% SLENDER WHEATGRASS (AGROPYRON TRACHYCAULUM VAR. TRACHYCAULUM)
- 15% WESTERN WHEAT (AGROPYRON SMITHII)
- 5% SLOUGHGRASS (BECKMANNIA SYZIGACHNE)
- 5% IDAHO FESCUE (FESTUCA IDAHOENSIS)
- 5% ALKALI BLUEGRASS (POA SECUNDA SPP. JUNCIFOLIA)
- 5% JUNEGRASS (KOELERIA MACRANTHA)
- 5% SANDBERG BLUEGRASS (POA SECUNDA)
- 20% GREEN NEEDLEGRASS (STRIPA VIRIDULA)
- 10% ROCKY MOUNTAIN FESCUE (FESTUCA SAXIMONTANA)

SEED RATE: 250KG PER HECTARE

PLANT MATERIAL LIST: (THIS SHEET ONLY)

QTY./SYM.	BOTANICAL/COMMON NAME	SIZE	CONDITION
DECIDUOUS SHRUBS			
(17) sb	<i>Salix brachycarpa</i> 'Blue fox' BLUE FOX WILLOW	450 mm HT. MIN. #5 CONTAINER	CONTAINER GROWN, OR BALLED & BURLAPPED 4 CANES OR MORE 400mm HT. WITH MIN ROOT SPREAD 250mm.

NOTE: ALL TREES TO BE HIGH HEADED AND EXHIBIT A FULL AND UNIFORM CROWN, WITH A SINGLE, DOMINANT, WELL DEVELOPED LEADER; TREES WITH BROKEN OR DAMAGED OR MISSING LEADERS WILL NOT BE ACCEPTED. ALL PLANT MATERIAL MUST CONFORM TO THE CITY OF EDMONTON DESIGN AND CONSTRUCTION STANDARDS.

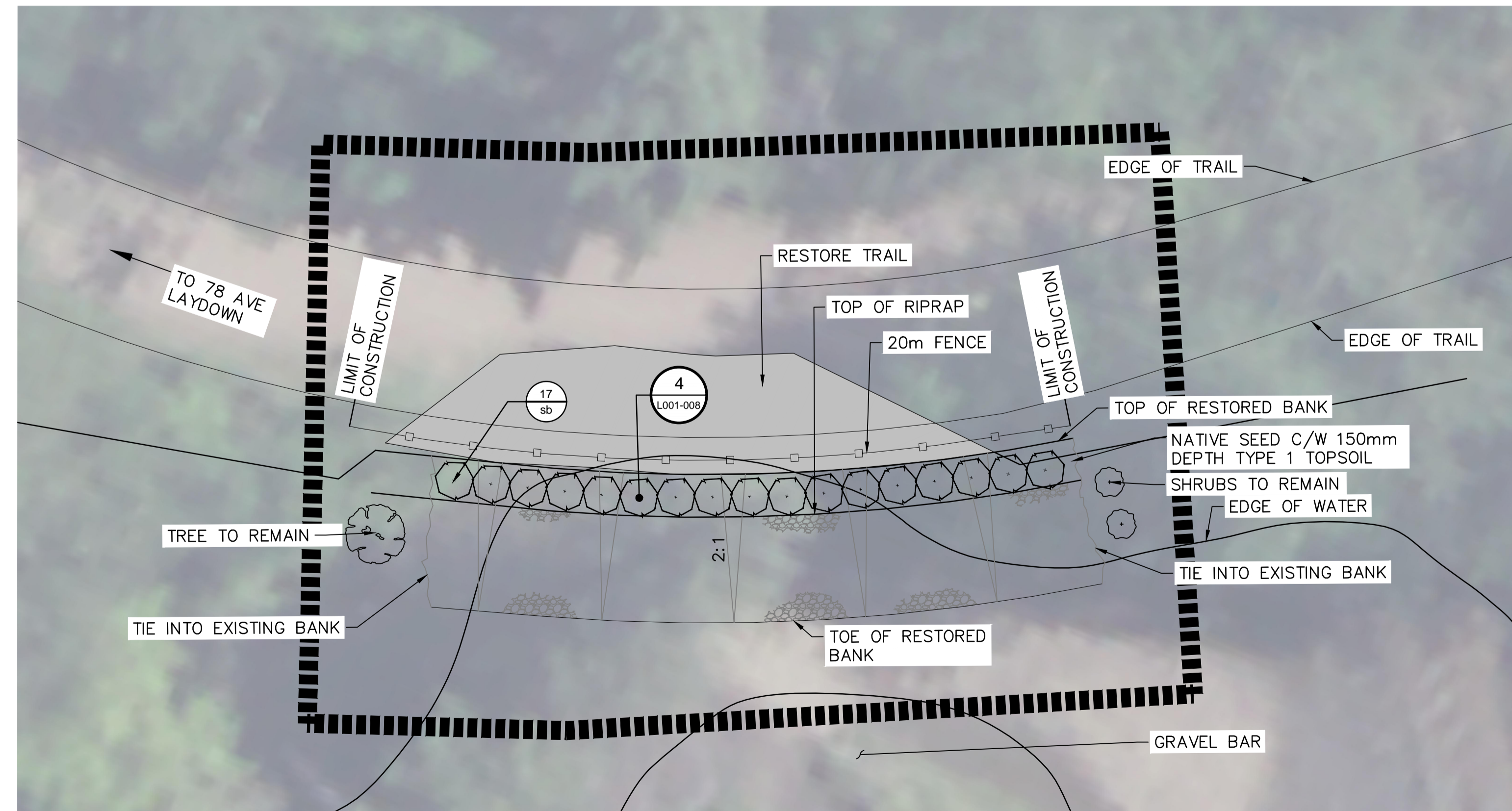

1 SITE #3 PLANTING PLAN
SCALE: 1:100



Stantec Consulting Ltd.
10160 - 112 Street
Edmonton AB Canada
Tel. 780.917.7000
www.stantec.com

Copyright Reserved

The Contractor shall verify and be responsible for all dimensions. DO NOT scale the drawing - any errors or omissions shall be reported to Stantec without delay. The Copyrights to all designs and drawings are the property of Stantec. Reproduction or use for any purpose other than that authorized by Stantec is forbidden.

Legend

- POST AND RAIL FENCING
- EXISTING GRANULAR TRAIL
- PROPOSED CONTOUR
- EXISTING CONTOUR (MAJOR)
- EXISTING CONTOUR (MINOR)
- LIMIT OF CONSTRUCTION
- DETAIL REFERENCE SYMBOL
- 1 L001-001 DETAIL NUMBER SHEET NUMBER

Notes

UTILITY SETBACKS

LANDSCAPE CONTRACTOR TO CALL 'ALBERTA ONE-CALL' AT 1-800-242-3447 TO HAVE ALL EXISTING SITE UTILITIES LOCATED PRIOR TO CONSTRUCTION AND PLANT NO CLOSER THAN THE FOLLOWING DIMENSIONS FROM THE SERVICES:

1. 1.0 m FROM POWER LINES
2. 3.5 m FROM ALL POWER HARDWARE
3. 1.8 m FROM WATER MAINS, WATER VALVES, MANUAL AIRVENTS, AND SERVICES
4. 2.0 m FROM SEWER MAINS, AND MANHOLES
5. 1.8 m FROM SEWER SERVICES
6. 1.5 m FROM GAS (NO TREES WITHIN EASEMENT)
7. 7.5 m FROM STREET CORNERS.
8. 3.5 m FROM FIRE HYDRANTS.
9. 1.5 m FROM DRIVEWAYS
10. 1.5 m FROM ALLEY ACCESSES
11. 1.0 m FROM SIDEWALKS
- OR AS PER APPROVED ENG. CROSS SECTIONS
12. 3.5 m FROM TRANSIT ZONES
13. 3.0 m FROM PRIVATE PROPERTY BOUNDARY
14. 1.25 m FROM COLLECTOR ROAD CURB FACE
15. 1.25 m FROM LOCAL ROAD CURB FACE
16. 2.0 m FROM ARTERIAL ROAD CURB FACE
17. 3.5 m FROM YIELD AND STOP SIGNS
18. 3.5 m FROM BUS STOP SIGNS
19. 2.0 m FROM ALL OTHER SIGNS
20. 1.0 m FROM OTHER UNDERGROUND UTILITIES
21. 3.5 m FROM TELUS PEDESTALS
22. 2.0 m FROM TELUS DUCT STRUCTURE
23. 1.0 m FROM TELUS CABLE FACILITIES

LANDSCAPE CONTRACTOR IS RESPONSIBLE FOR DAMAGES AND LIABILITIES INCURRED BY DAMAGES TO SITE UTILITIES.

Development Engineer, Sustainable Development			
Approvals			YY.MM.DD
Revision	By	Appd.	YY.MM.DD
1: FIRST SUBMISSION (60%)	DW	NGS	18.05
Issued	By	Appd.	YY.MM
File Name: LA_McCreek.dwg	DW	CB	NGS
	Dwn.	Chkd.	Dsgn.
			18.03.13
			YY.MM.DD

Permit-Seal



Client/Project

CITY OF EDMONTON

MILL CREEK RAVINE PARK
TRAIL REHABILITATION

Edmonton, Alberta

Title

SITE #3 PLANTING PLAN

Project No.
1161106255

Scale
1:100

V:\1161\active\1161106255\drawing_Landscape\LA_McCreek.dwg

2018-12-05 3:32pm BY: DWIGGLESWORTH

Drawing No.

L001-008

8 of 10

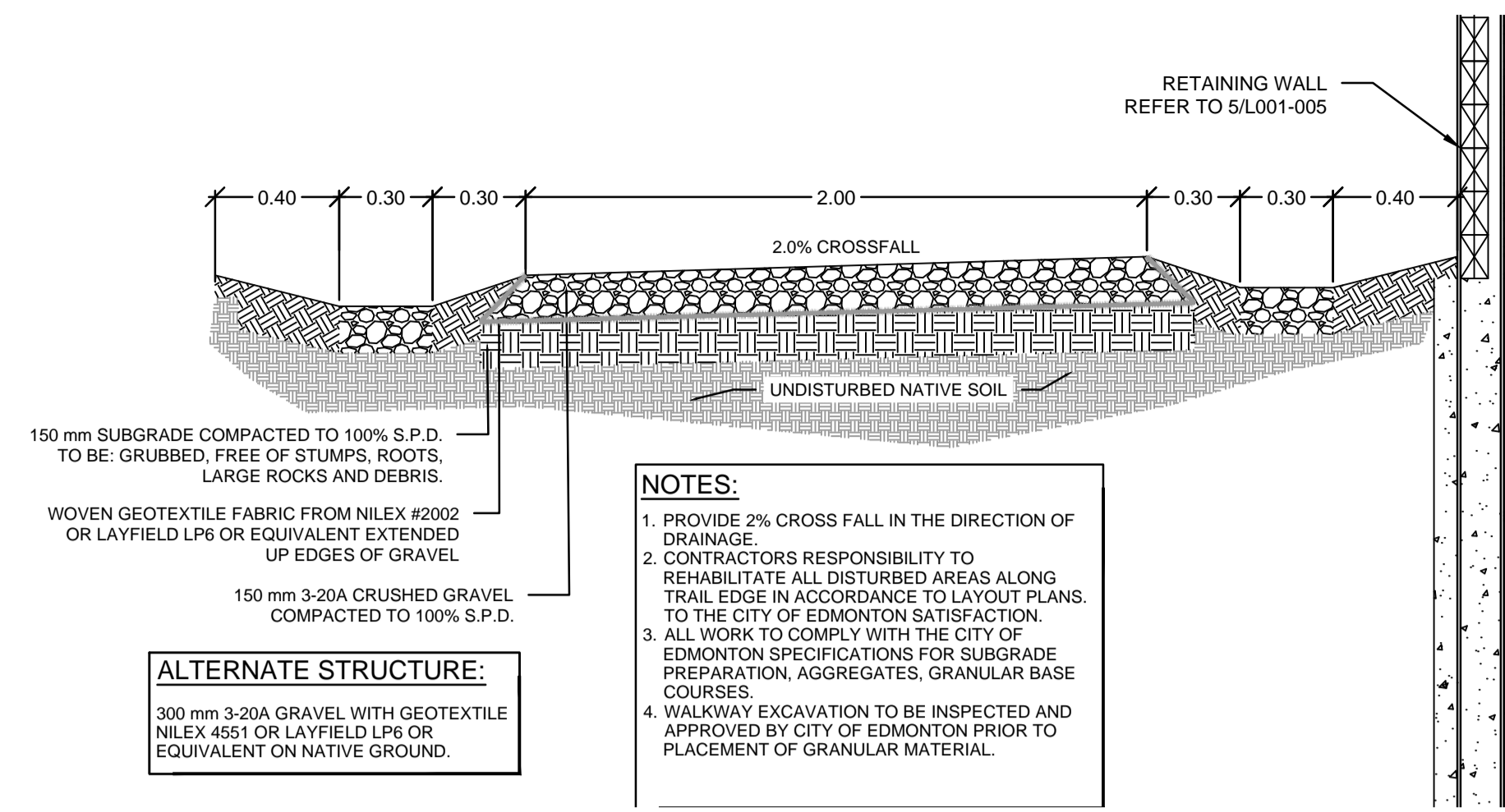

1 GRANULAR TRAIL WITH RETAINING WALL
SCALE: 1:20

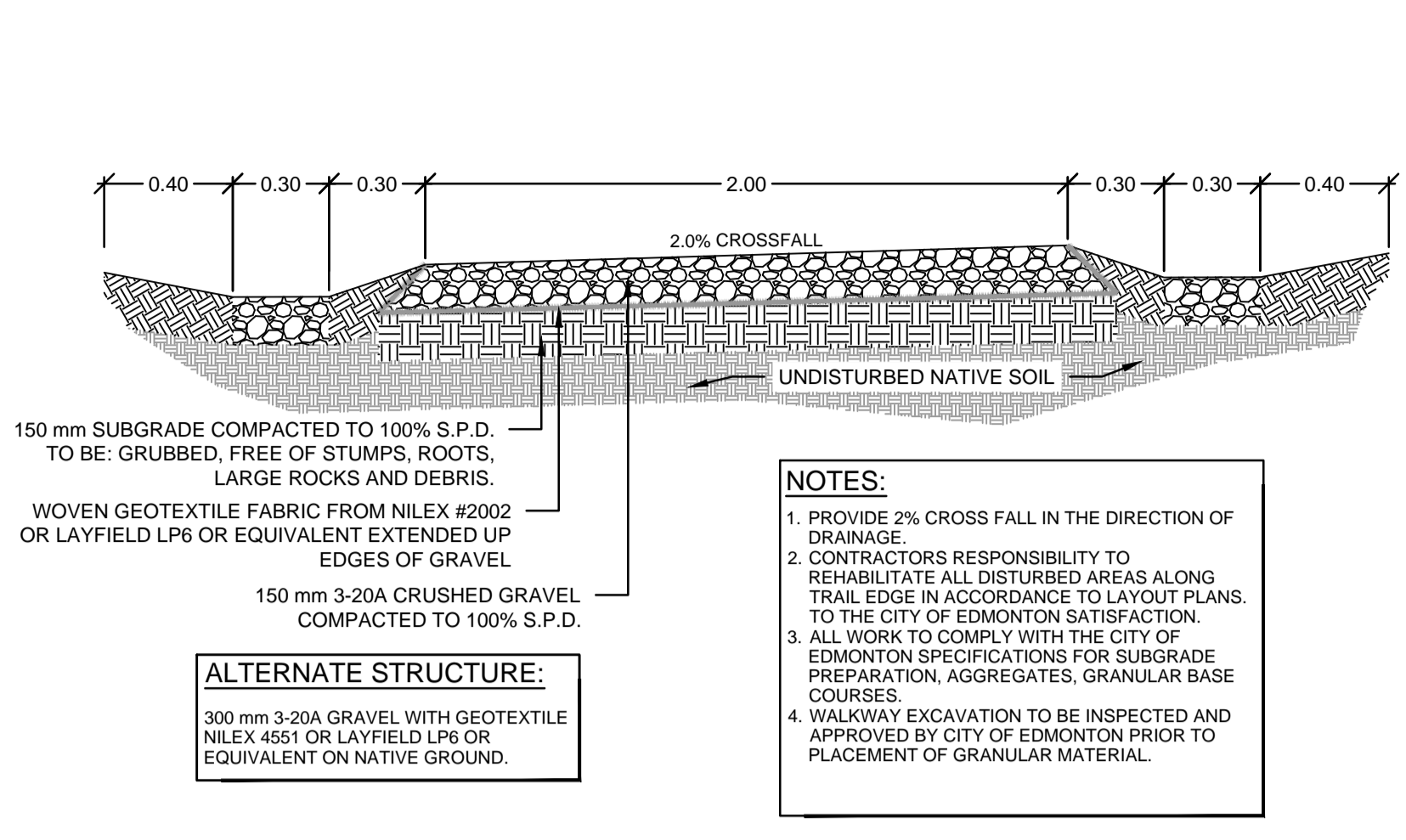

2 GRANULAR TRAIL WITH SWALES
SCALE: 1:20

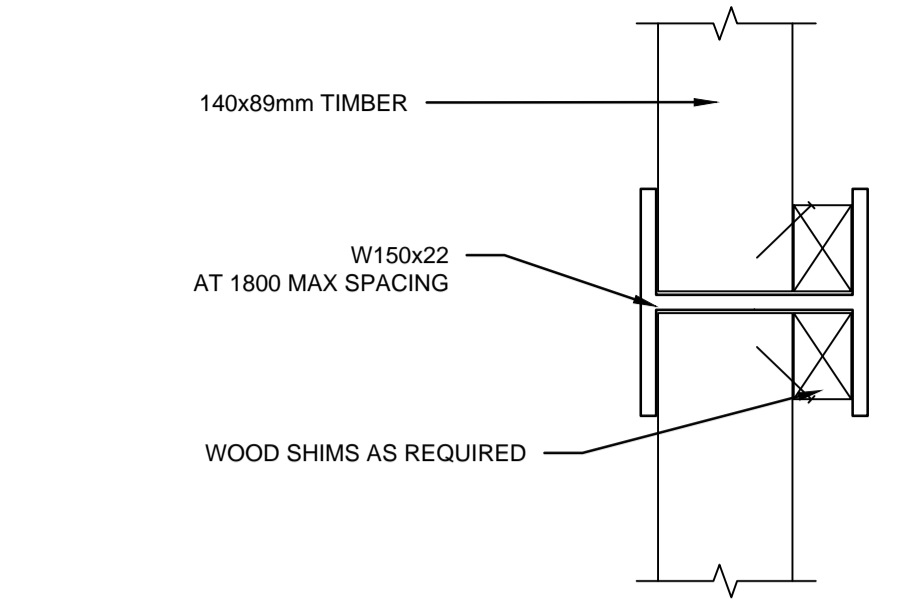

A-A RETAINING WALL SECTION
SCALE: 1:5

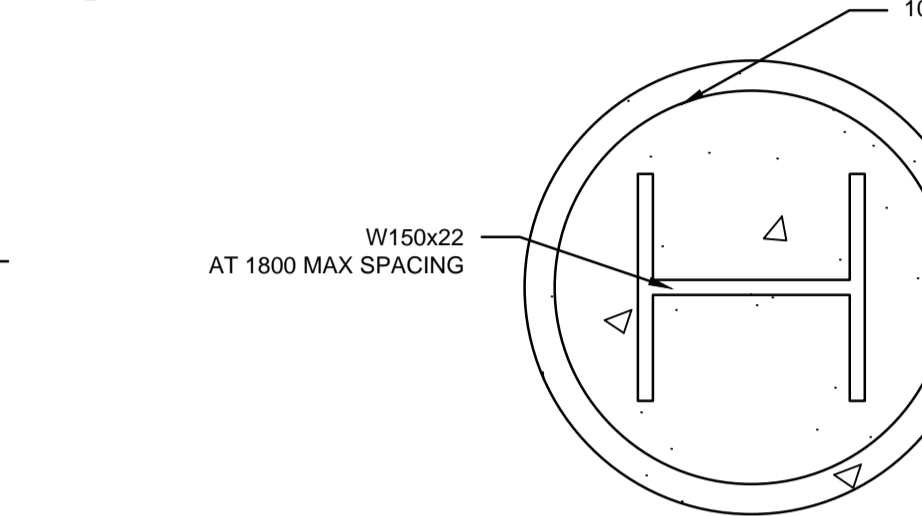

B-B RETAINING WALL SECTION
SCALE: 1:5

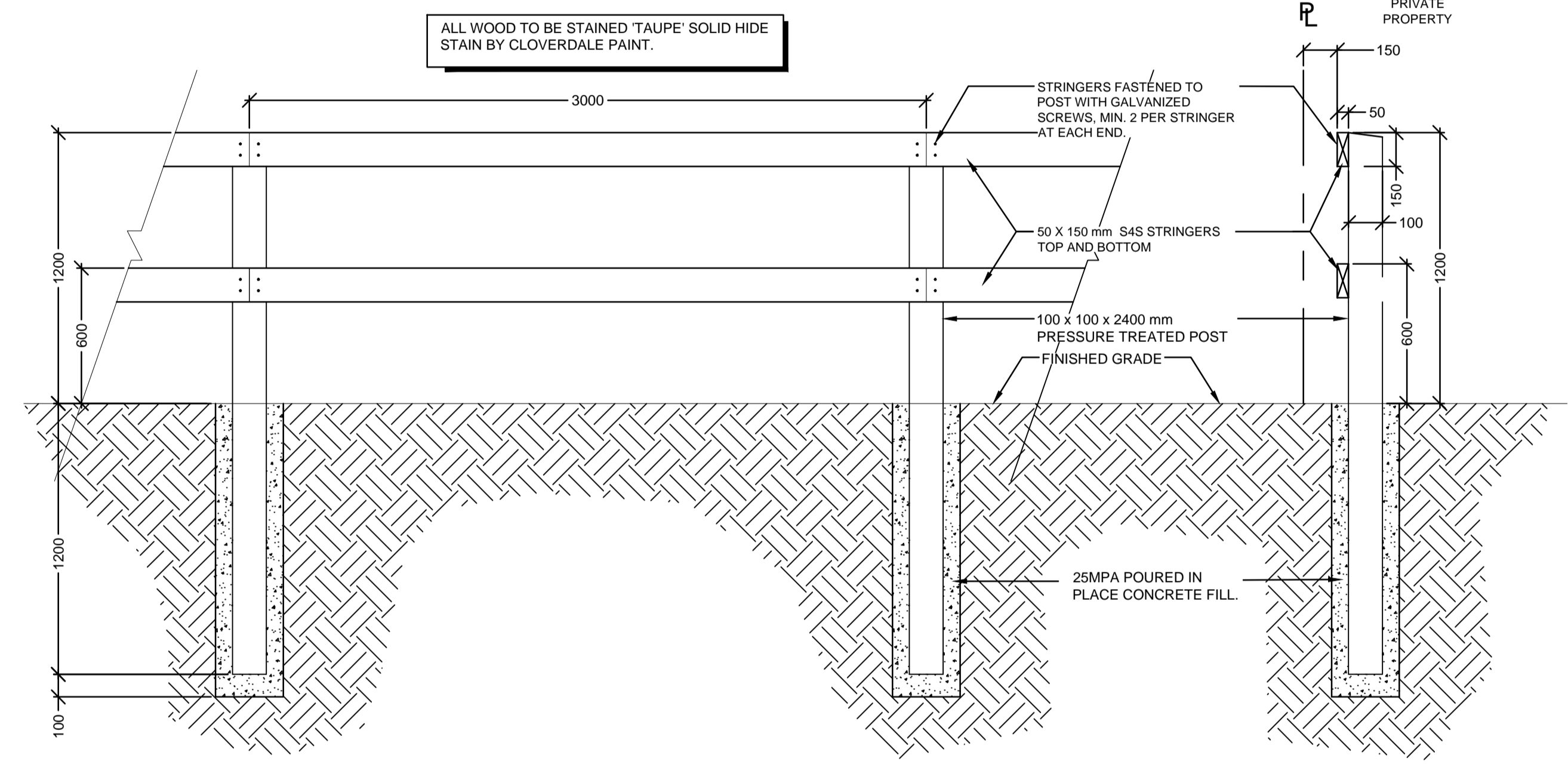

3 1.2m POST AND RAIL FENCE
SCALE: 1:20

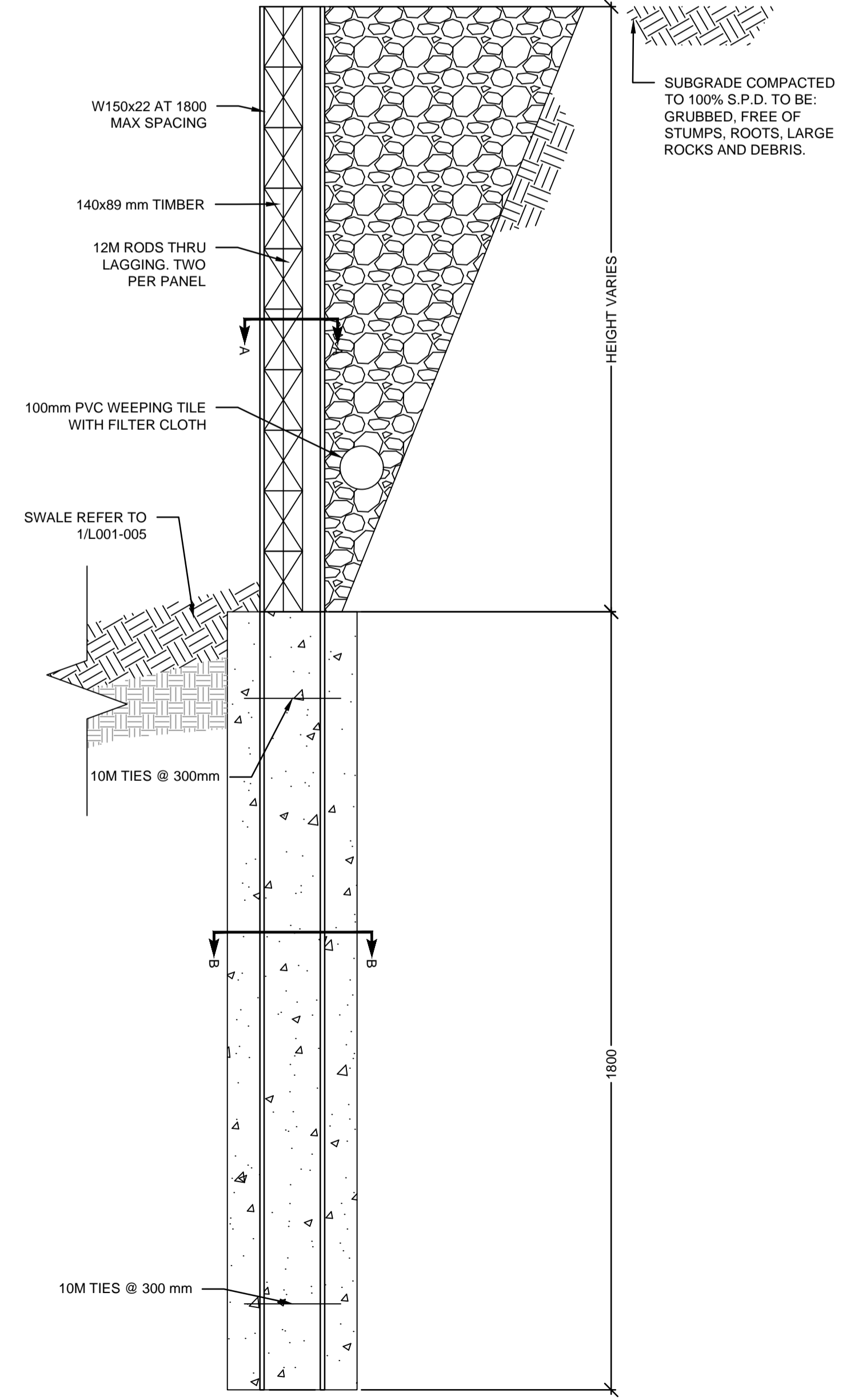

5 RETAINING WALL ELEVATION
SCALE: 1:20

RETAINING WALL NOTES:

1. WEEPING TILE TO BE 100mm DIA. PERFORATED POLYVINYL-CHLORIDE PIPE, C/W SOLVENT SEAL COUPLINGS, TEES, ELBOWS, FITTINGS, ETC. FILTER CLOTH TO BE NON-WOVEN POLYESTER SLEEVE EQUAL TO "REVIRA SPUNBOND NO.1114" AS SUPPLIED BY ARMTEC CONSTRUCTION PRODUCTS. PLACE FILTER CLOTH AROUND PIPE THE BACKFILL WITH GRANULAR FILL. PITCH PIPE 1/80 TO LOW END OF WALL AND DAYLIGHT.
2. BACKFILL TO BE FREE DRAINING PEA GRAVEL LIGHTLY COMPACTED.
3. DO NOT PROCEED WITH BACKFILLING OPERATIONS UNTIL ENGINEER HAS INSPECTED AND APPROVED INSTALLATIONS.
4. DO CONCRETE FORMWORK, REINFORCEMENT AND CAST-IN-PLACE CONCRETE IN ACCORDANCE WITH CSA A23.1 EXCEPT WHERE SPECIFIED ELSEWHERE.
5. REINFORCED BARS: BILLET STEEL, GRADE 400, DEFORMED BARS TO CAS G30.18-09 EXCEPT BEAM AND COLUMN TIES WHICH SHALL BE GRADE 300.
6. IMMEDIATELY FOLLOWING DRILLING OF THE PILE SHAFTS, AND CLEANING INSTALL WIDE FLANGE POST, REINFORCING STEEL AND PLACE CONCRETE.
7. PROPORTION NORMAL DENSITY CONCRETE TO CSA A23.1 FOR ALL CONCRETE TO GIVE 25 MPa IN 28 DAYS USING TYPE HS CEMENT, 20mm COARSE AGGREGATE, 75mm SLUMP, 5 TO 7% ENTRAINED AIR AND A WATER CEMENTING MATERIAL RATIO OF 0.5.
8. STRUCTURAL STEEL TO BE HOT ROLLED SECTIONS TO CAN S G40.21, 350W.
9. SHOP PAINT PRIMER TO CIS/CPMA 1-73Aa. SHOP PRIME TO CAN/CSA-S16-01 ALL STEEL MEMBERS EXCEPTING SURFACES IN CONTACT WITH CAST AREAS TO RECEIVE WELDING WORK.
10. ALL LUMBER TO BE PRESSURE TREATED SPF NO. 1 & 2, OR BETTER.
11. BOLTS, NUTS, WASHERS, LAGS, PINS, AND SCREWS TO BE HOT DIP GALVANIZED TO CSA G164.
12. WOOD PRESERVATIVE TO BE PENTACHLOROPHENOL BASE WATER REPELLENT WOOD PRESERVATIVE. TREAT CUT ENDS WITH END CUT PRESERVATIVE.

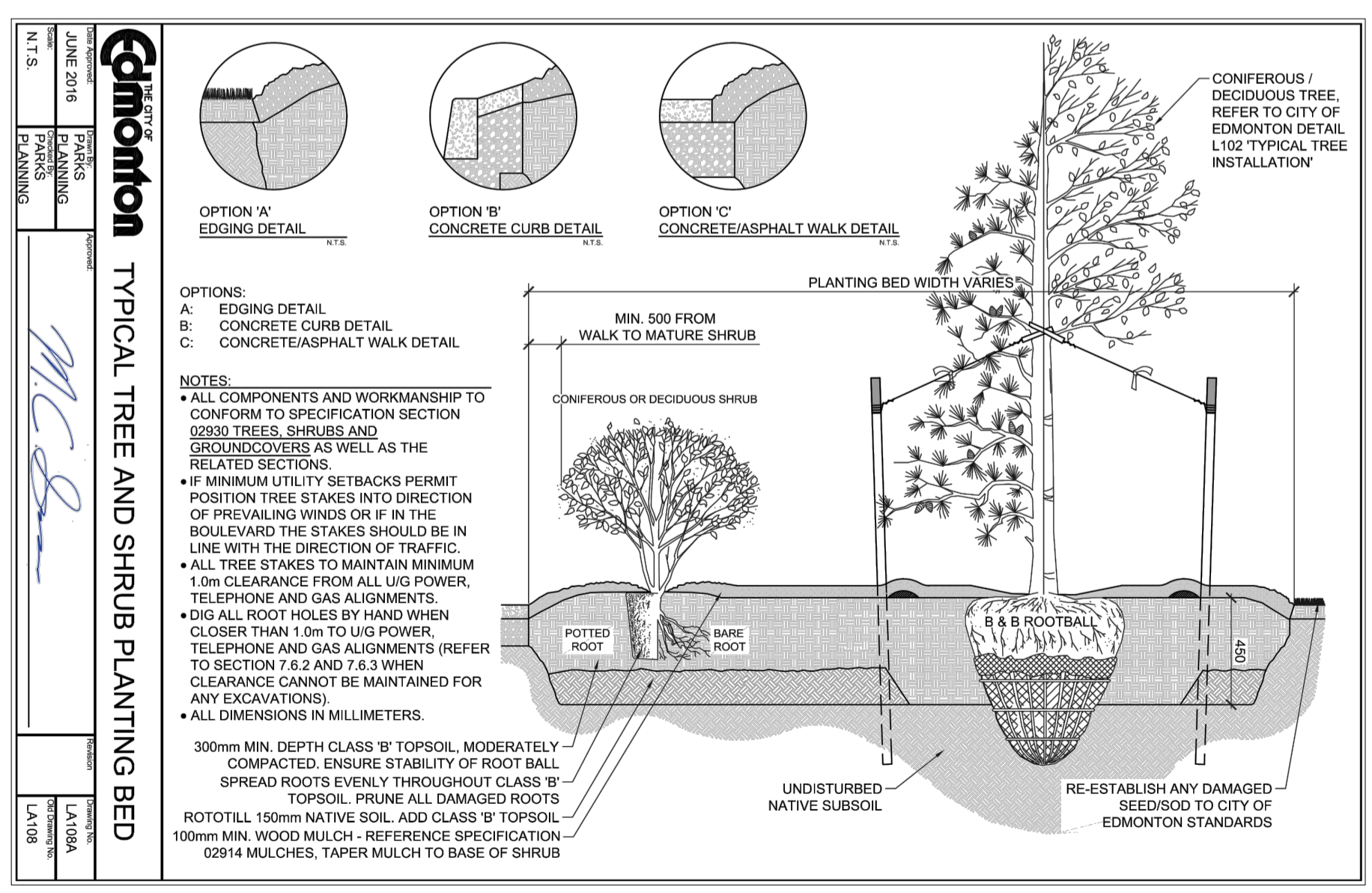

4 TYPICAL TREE AND SHRUB PLANTING BED
SCALE: N.T.S.



Stantec Consulting Ltd.
10160 - 112 Street
Edmonton AB Canada
Tel. 780.917.7000
www.stantec.com

Copyright Reserved
The Contractor shall verify and be responsible for all dimensions. DO NOT scale the drawing - any errors or omissions shall be reported to Stantec without delay. The Copyrights to all designs and drawings are the property of Stantec. Reproduction or use for any purpose other than that authorized by Stantec is forbidden.

Legend

Notes
UTILITY SETBACKS
LANDSCAPE CONTRACTOR TO CALL 'ALBERTA ONE-CALL' AT 1-800-242-3447 TO HAVE ALL EXISTING SITE UTILITIES LOCATED PRIOR TO CONSTRUCTION AND PLANT NO CLOSER THAN THE FOLLOWING DIMENSIONS FROM THE SERVICES:

1. 1.0 m FROM POWER LINES
 2. 3.5 m FROM ALL POWER HARDWARE
 3. 1.8 m FROM WATER MAINS, WATER VALVES, MANUAL AIRVENTS, AND SERVICES
 4. 2.0 m FROM SEWER MAINS, AND MANHOLES
 5. 1.8 m FROM SEWER SERVICES
 6. 1.5 m FROM GAS (NO TREES WITHIN EASEMENT)
 7. 7.5 m FROM STREET CORNERS.
 8. 3.5 m FROM FIRE HYDRANTS.
 9. 1.5 m FROM DRIVEWAYS
 10. 1.5 m FROM ALLEY ACCESSES
 11. 1.0 m FROM SIDEWALKS
- OR AS PER APPROVED ENG. CROSS SECTIONS
12. 3.5 m FROM TRANSIT ZONES
 13. 3.0 m FROM PRIVATE PROPERTY BOUNDARY
 14. 1.25 m FROM COLLECTOR ROAD CURB FACE
 15. 1.25 m FROM LOCAL ROAD CURB FACE
 16. 2.0 m FROM ARTERIAL ROAD CURB FACE
 17. 3.5 m FROM YIELD AND STOP SIGNS
 18. 3.5 m FROM BUS STOP SIGNS
 19. 2.0 m FROM ALL OTHER SIGNS
 20. 1.0 m FROM OTHER UNDERGROUND UTILITIES
 21. 3.5 m FROM TELUS PEDESTALS
 22. 2.0 m FROM TELUS DUCT STRUCTURE
 23. 1.0 m FROM TELUS CABLE FACILITIES

LANDSCAPE CONTRACTOR IS RESPONSIBLE FOR DAMAGES AND LIABILITIES INCURRED BY DAMAGES TO SITE UTILITIES.

Development Engineer, Sustainable Development			
Approvals			YY.MM.DD
Revision	By	Appd.	YY.MM.DD
1. FIRST SUBMISSION (60%)	DW	NGS	18.05
Issued	By	Appd.	YY.MM
File Name: LA_MCreek.dwg	DW	CB	NGS
	Dwn.	Chkd.	Dsgn.
			YY.MM.DD

Permit-Seal
The Alberta Association of Landscape Architects
Natalie Goulet-Sorenson

Client/Project
CITY OF EDMONTON
MILL CREEK RAVINE PARK TRAIL REHABILITATION
Edmonton, Alberta

Title
DETAILS

Project No. 1161106255 Scale AS SHOWN

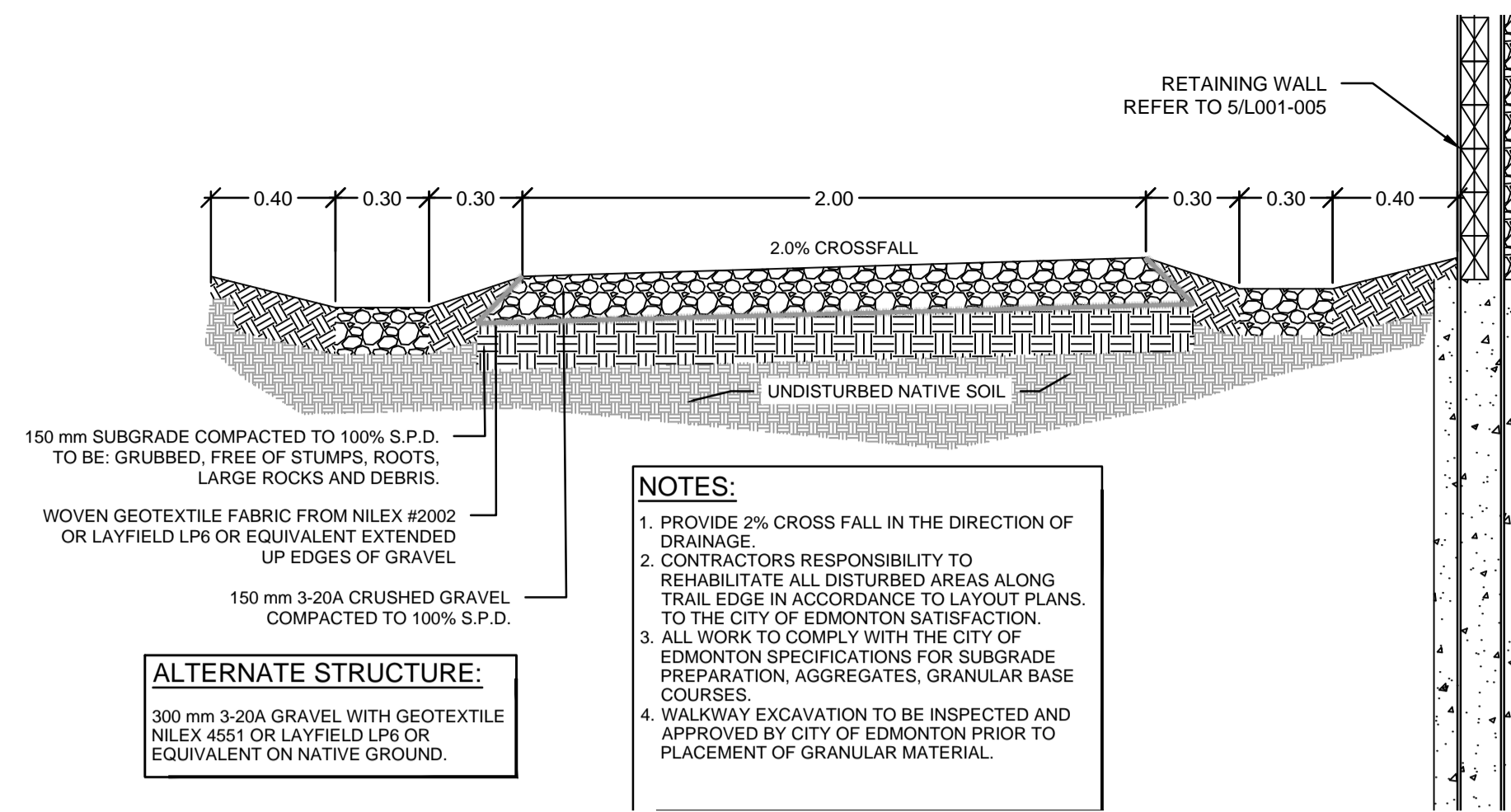

1 GRANULAR TRAIL WITH RETAINING WALL
SCALE: 1:20



Stantec Consulting Ltd.
10160 - 112 Street
Edmonton AB Canada
Tel. 780.917.7000
www.stantec.com

Copyright Reserved

The Contractor shall verify and be responsible for all dimensions. DO NOT scale the drawing - any errors or omissions shall be reported to Stantec without delay. The Copyrights to all designs and drawings are the property of Stantec. Reproduction or use for any purpose other than that authorized by Stantec is forbidden.

Legend

Notes

UTILITY SETBACKS

LANDSCAPE CONTRACTOR TO CALL 'ALBERTA ONE-CALL' AT 1-800-242-3447 TO HAVE ALL EXISTING SITE UTILITIES LOCATED PRIOR TO CONSTRUCTION AND PLANT NO CLOSER THAN THE FOLLOWING DIMENSIONS FROM THE SERVICES:

1. 1.0 m FROM POWER LINES
2. 3.5 m FROM ALL POWER HARDWARE
3. 1.8 m FROM WATER MAINS, WATER VALVES, MANUAL AIRVENTS, AND SERVICES
4. 2.0 m FROM SEWER MAINS, AND MANHOLES
5. 1.8 m FROM SEWER SERVICES
6. 1.5 m FROM GAS (NO TREES WITHIN EASEMENT)
7. 7.5 m FROM STREET CORNERS.
8. 3.5 m FROM FIRE HYDRANTS.
9. 1.5 m FROM DRIVEWAYS
10. 1.5 m FROM ALLEY ACCESSSES
11. 1.0 m FROM SIDEWALKS
OR AS PER APPROVED ENG. CROSS SECTIONS
12. 3.5 m FROM TRANSIT ZONES
13. 3.0 m FROM PRIVATE PROPERTY BOUNDARY
14. 1.25 m FROM COLLECTOR ROAD CURB FACE
15. 1.25 m FROM LOCAL ROAD CURB FACE
16. 2.0 m FROM ARTERIAL ROAD CURB FACE
17. 3.5 m FROM YIELD AND STOP SIGNS
18. 3.5 m FROM BUS STOP SIGNS
19. 2.0 m FROM ALL OTHER SIGNS
20. 1.0 m FROM OTHER UNDERGROUND UTILITIES
21. 3.5 m FROM TELUS PEDESTALS
22. 2.0 m FROM TELUS DUCT STRUCTURE
23. 1.0 m FROM TELUS CABLE FACILITIES

LANDSCAPE CONTRACTOR IS RESPONSIBLE FOR DAMAGES AND LIABILITIES INCURRED BY DAMAGES TO SITE UTILITIES.

Development Engineer, Sustainable Development

Approvals				YY.MM.DD

Revision

	By	Appd.	YY.MM.DD

1. FIRST SUBMISSION (60%)

Issued

File Name:	LA_MCCreek.dwg	DW	CB	NGS	18.05
		Dwn.	Chkd.	Dsgn.	YY.MM.DD

Permit-Seal



Natalie
Goulet-Sorenson

Client/Project

CITY OF EDMONTON

MILL CREEK RAVINE PARK
TRAIL REHABILITATION

Edmonton, Alberta

Title

DETAILS

Project No.

1161106255

Scale

AS SHOWN

V:\1161\active\1161106255\drawing_Landscape\LA_MCCreek.dwg

2018-12-05 3:32pm BY: DWIGLSEWORTH

Drawing No.

L001-010

APPENDIX 2

Site Assessment & Design Analysis Report

**Mill Creek Ravine Park Trail
Rehabilitation**

**Site Assessment & Design
Analysis Report**

File: 1161 106255



Prepared for:
City of Edmonton
Prepared by:
Stantec Consulting Ltd.

January 2019

Sign-off Sheet

This document entitled Mill Creek Ravine Park Trail Rehabilitation Site Assessment & Design Analysis Report was prepared by Stantec Consulting Ltd. for the account of City of Edmonton. Any reliance on this document by any third party is strictly prohibited. The material in it reflects Stantec's professional judgment in light of the scope, schedule, and other limitations stated in the document and in the contract between Stantec and the Client. The opinions in the document are based on conditions and information existing at the time the document was published and do not take into account any subsequent changes. In preparing the document, Stantec did not verify information supplied to it by others. Any use which a third party makes of this document is the responsibility of such third party. Such third party agrees that Stantec shall not be responsible for costs or damages of any kind, if any, suffered by it or any other third party as a result of decisions made or actions taken based on this document.

Prepared by *Brian Charanduk*
(signature)

Brian Charanduk, Principal

Reviewed by *Jon Ouellette*
(signature)

Jon Ouellette, Principal

Table of Contents

1.0	INTRODUCTION	1.1
1.1	SITE LOCATION AND INTENDED USE	1.2
	1.1.1 Site 1	1.2
	1.1.2 Site 2	1.3
	1.1.3 Site 3	1.4
2.0	EXISTING SITE CONDITIONS	2.1
2.1	VISUAL SITE ASSESSMENT.....	2.1
	2.1.1 Site 1	2.1
	2.1.2 Site 2	2.3
	2.1.3 Site 3	2.3
2.2	GEOTECHNICAL INVESTIGATION.....	2.4
3.0	REHABILITATION DESIGN.....	3.1
3.1	SITE 1	3.1
	3.1.1 Option 1 Upgrade Existing Unmaintained Path	3.1
	3.1.2 Option 2 Establish New Trail Ties Into Existing Unmaintained Path.....	3.1
3.2	SITE 2	3.3
	3.2.1 Option 1 Short Radius Trail with Retaining Wall	3.3
	3.2.2 Option 2 Long Radius Trail with Retaining Wall	3.4
	3.2.3 Option 3 Upgrade Existing Unmaintained Trail.....	3.4
3.3	SITE 3	3.6
	3.3.1 Option 1 Minor Trail Realignment	3.6
	3.3.2 Option 2 Major Trail Realignment.....	3.7
	3.3.3 Option 3 Rehabilitation of the Existing Trail and Creek Bank Restoration.....	3.8
3.4	PREFERRED CONCEPTS	3.10
	3.4.1 Site 1	3.10
	3.4.2 Site 2	3.10
	3.4.3 Site 3	3.10
3.5	ENVIRONMENTAL	3.11
3.6	OPINION OF PROBABLE COST	3.11
3.7	CONCEPTUAL CONSTRUCTION SCHEDULE.....	3.11

LIST OF APPENDICES

APPENDIX A.....	A.1
Opinion of Probable Costs	A.1

1.0 INTRODUCTION



Figure 1 Study Site Locations

Millcreek Ravine Park Trail is a well-loved green space in the heart of the Millcreek Ravine. Like many other trails in the North Saskatchewan River Valley, the effects of creek erosion, severe weather, and extensive use are compromising the trail system. The City of Edmonton (City) has a significant challenge in trying to manage the 760 kilometers of trails in the river valley. As part of a renewed focus on the trail system, this NRFP focuses on three sections of eroding trail in Millcreek Park as shown in **Figure 1**.

Mill Creek Ravine Park Trail Rehabilitation

Site Assessment & Design Analysis Report

The two main influences on the trail deterioration are natural creek bed erosion and trail use. Our proposal presents a holistic approach that combines technical analysis of each site, combined with an assessment of how the trails are used. Our project team reflects this approach, with the combined disciplines of landscape architecture, geotechnical, hydrotechnical and environmental investigation. This integration will be illustrated by our Opportunities and Constraints Plan, which will establish the influence of all aspects of the existing site and its uses, including technical assessments of slope, creek and soil, wildlife habitat and trail user's movements.

1.1 SITE LOCATION AND INTENDED USE

1.1.1 Site 1

Site 1 is located approximately 250 m northwest of 95 St and 90 Ave and 20 m south of Bridge 277 (53° 31' 33.0212" N, 113° 28' 36.4282" W), the existing 3 m wide gravel path provides connectivity on the east bank of Mill Creek between Connors Road and Mill Creek pool, as shown in **Figure 2**. The Creek has eroded the right bank and resulted in a 3.5 m high cut bank which has consumed the path for approximately 10 m, rendering it effectively impassible.

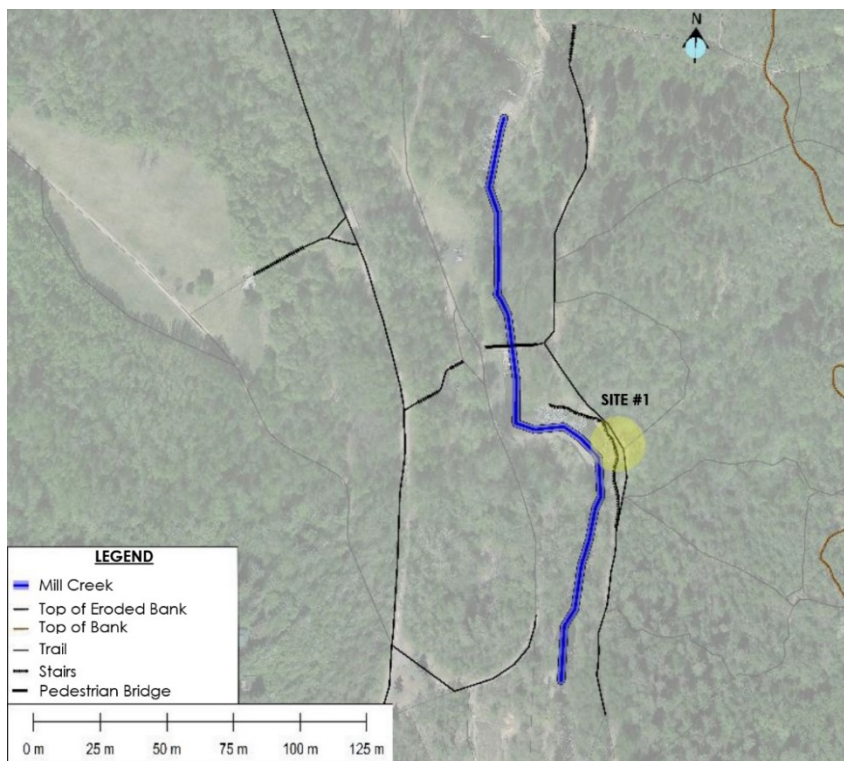

Figure 2 Site 1 shown on 2010 Base Image

Mill Creek Ravine Park Trail Rehabilitation

Site Assessment & Design Analysis Report

1.1.2 Site 2

Site 2 is located approximately 90 m north of 82 Ave and 150 m east of 95A St (53° 31' 07.1839" N, 113° 28' 24.8983" W), the existing 2 m wide gravel trail follows the crest of a semi-active land slide and provides connectivity on the east bank of Mill Creek between Mill Creek pool and 76 Avenue, as shown in **Figure 3**.

The trail follows part of the 82 Avenue alignment that was established in 1911 and was spanned by a 150 m (495') steel viaduct (Alberta Transportation bridge file 6617) which was replaced by the existing 8-span 222.7 m (2-80', 4-98' plus approach spans) concrete girder bridge in 1961. Concrete footings from the original span can be seen in the Creek bed and on the northeast slope below the trail.

Mill Creek turns 90° at the toe of slope below the trail, resulting in a 10 m high cut bank, where the trail traverses the crest. Approximately 7 m of trail is currently protected by timber rail, but on-going toe erosion threatens to trigger a slide which will render the trail impassible.

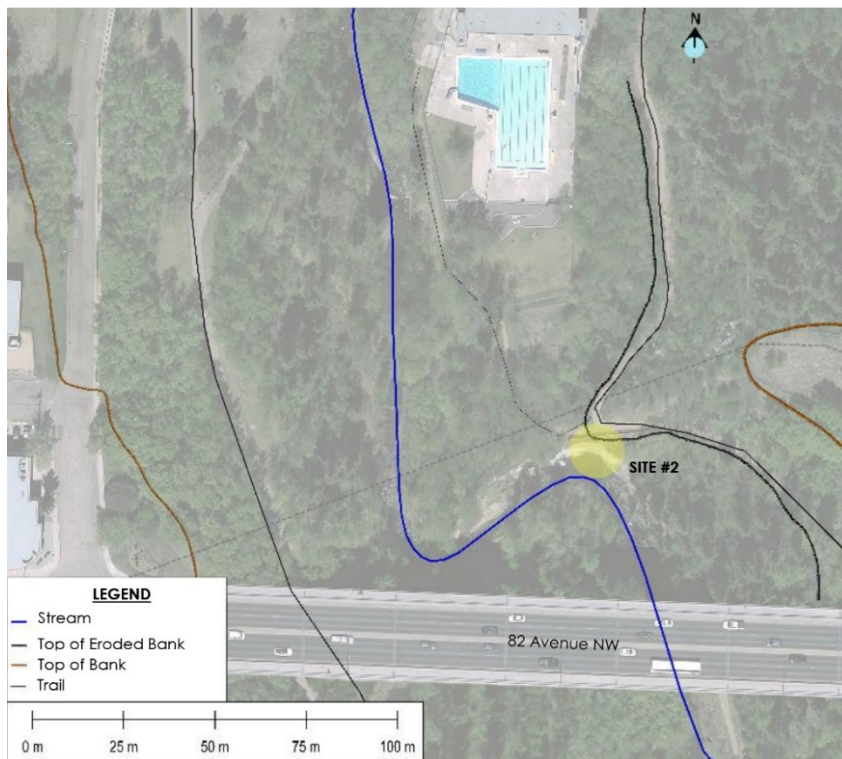

Figure 3 Site 2 shown on 2010 Base Image

Mill Creek Ravine Park Trail Rehabilitation

Site Assessment & Design Analysis Report

1.1.3 Site 3

Site 3 is located approximately 135 m southwest of 78 Ave and 93 St, roughly 30 m north of Bridge 207 (53° 30' 47.4500" N 113° 28' 19.6327" W), the existing 3 m wide gravel trail has been narrowed to approximately 2 m over a 6 m length where Mill Creek has eroded its right (looking downstream) bank. The gravel trail provides connectivity on the east bank of Mill Creek between Mill Creek Pool and 82 Avenue, as shown in **Figure 4**.

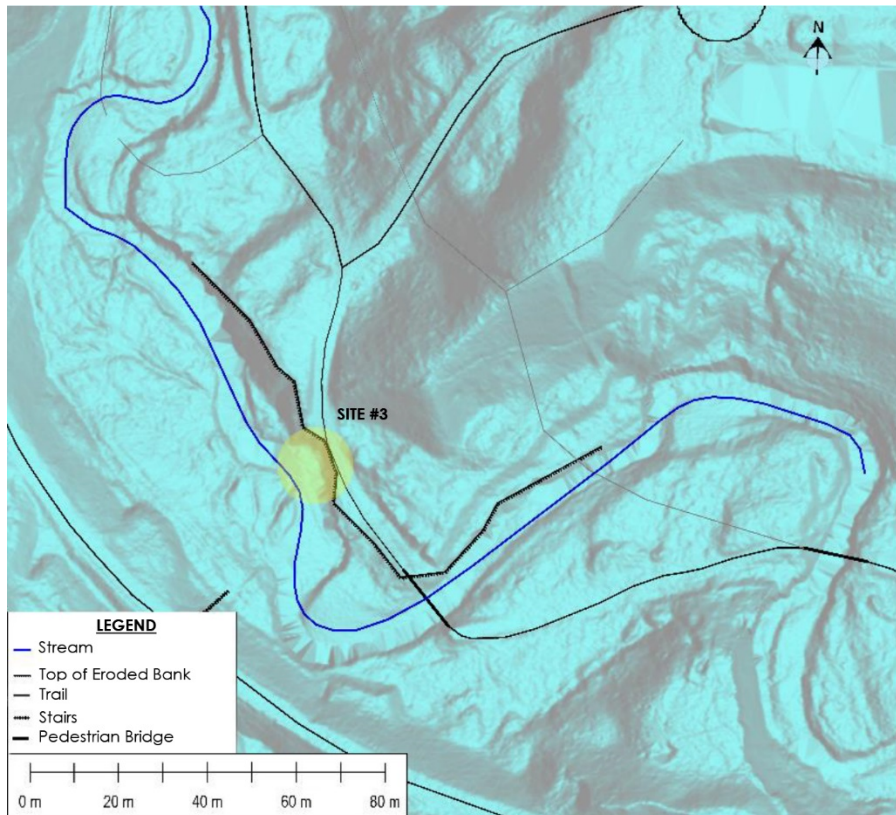

Figure 4 Site 3 shown on Bare Earth LiDAR Image

2.0 EXISTING SITE CONDITIONS

A joint site inspection was conducted by City of Edmonton representatives and Stantec on May 16, 2017. The following sections describe our observations from our site visit.

2.1 VISUAL SITE ASSESSMENT

2.1.1 Site 1

The erosion area referred to as Site 1, is immediately south of Bridge 277, shown in **Figure 5**, on a north-south segment of gravel path connecting Connors Road to Mill Creek pool on the east side of Mill Creek. The Creek is actively cutting the toe of slope, **Figure 6**, resulting in an approximately 3 m high vertical bank which has encroached on the trail and narrowed it to the point that it is no longer serviceable. Trail users have adopted a detour using an unmaintained path around the erosion site, connecting to the main trail north of the bridge as shown in **Figure 7**.



Figure 5 View from west side of bridge to access trail. Site 1 is to the right, Creek flows right to left.

Mill Creek Ravine Park Trail Rehabilitation
Site Assessment & Design Analysis Report



Figure 6 View of Site 1 trail eroding into creek - View looking south (left) and north (right).



Figure 7 Assessing trail alignment opportunities on Site 1. Bridge 277 is at the left of the photo.

2.1.2 Site 2

The trail connecting Mill Creek Pool to 76 Avenue traverses ancient landslide features and follows the top of a steep bank at the erosion site identified as Site 2 as shown in **Figure 8**. At this location the creek impinges on the valley wall, creating a nearly vertical 10 m high bank adjacent to the trail. A timber hand rail protects trail users from the drop, but that too is at risk of failure from on-going erosion.



Figure 8 Site 2 viewed from 82 Avenue Bridge, looking east

2.1.3 Site 3

Erosion Site 3 is located on the trail connecting Mill Creek Pool to 76 Avenue, immediately north of Bridge 207. At this site, the creek has created a gravel side bar on the west bank which directs flow to the east, impinging on the bank at Site 3 as shown in **Figure 9**. The relatively low bank is actively eroding as the creek turns west in a tight radius curve. The trail is still serviceable, having lost approximately 1 m of width, but users are exposed to a 2 m high cut bank.



Figure 9 Site 3 looking east from a gravel side bar

2.2 GEOTECHNICAL INVESTIGATION

Please refer to the Geotechnical Report for further detail.

3.0 REHABILITATION DESIGN

3.1 SITE 1

Rehabilitation options for Site 1 include trail realignment only. Although realignment of the creek and armoring of the right bank is a technically feasible option, that approach is unlikely to gain approval from the regulatory agencies. The objective in trail realignment is to establish a new path that is set back from the eroded area sufficient distance to avoid future service disruption from either bank erosion or slope failures.

3.1.1 Option 1 Upgrade Existing Unmaintained Path

An unmaintained trail exists to the east of the damaged granular trail as shown in **Figure 11**. Upgrading this path to granular standards would require removal of a few mature trees, a small amount of earthwork to smooth grades, and placement of crushed gravel surfacing material.

This option maintains logical desire path sight lines for northbound traffic; however, southbound traffic is not guided to the detour route as the desire path is focused on the bridge in the distance. Options for mitigating this problem include signage and widening the trail intersections to create a logical visual connection, as shown in **Figure 10**.

Because of the prevalence of unmaintained trails throughout Mill Creek, conversion of the existing unmaintained to granular standard, might result in a new unmaintained trail being created above the new path.

3.1.2 Option 2 Establish New Trail Ties Into Existing Unmaintained Path

Connecting the undamaged portion of the granular trail north of Bridge 277 to the undamaged portion south of the creek encroachment can be accomplished by establishing a new trail which ties into a portion of the existing unmaintained path. Extending the trail straight off Bridge 277 (**Alignment A on Figure 12**) and tying into the existing unmaintained trail can preserve logical path routing with minimal amount of new trail construction. Similar to Alignment A, Alignment B has more favorable grade lines and sight lines and also provides adequate setback from the eroding bank. **Alignment B on Figure 12** also follows favorable terrain, resulting in lower slopes and lower fill volumes to establish the path.



Figure 10 Site 3 looking south with Bridge 207 in the background

Mill Creek Ravine Park Trail Rehabilitation
 Site Assessment & Design Analysis Report

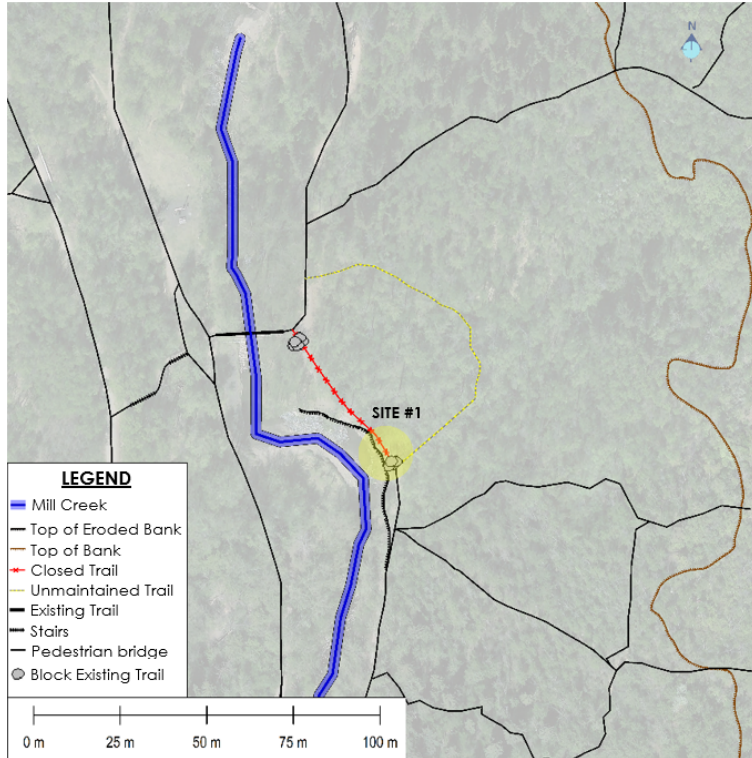

Figure 11 Site 1 - Option 1: Upgrade unmaintained path

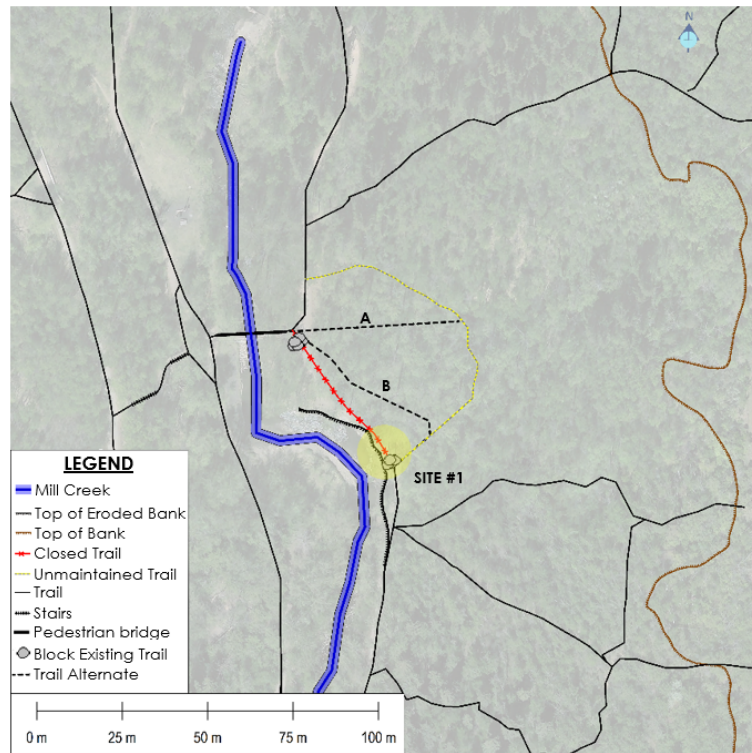

Figure 12 Site 1 - Option 2: Two options for New Trail, Tied into Existing Unmaintained Trail

Table 1 Site 1: Option Summary

Option	Advantage	Disadvantage
1 – Upgrade existing unmaintained trail	<ul style="list-style-type: none"> Minimal costs Uses existing alignment Minimal tree removal Maintains tree canopy Avoids eroding bank completely 	<ul style="list-style-type: none"> Sight lines are poor Desire path conflict Grades are steeper than others in the area Might precipitate creation of new path
2 – new trail tied into existing unmaintained	<ul style="list-style-type: none"> preserve existing sight lines good buffer to eroding bank preserve some existing unmaintained grades that can be improved in final design 	<ul style="list-style-type: none"> several trees need to be removed new construction narrow (+- 4 m) strip of existing tree cover isolated between bank and trail

3.2 SITE 2

Rehabilitation options for site 2 include trail realignments to avoid the actively eroding vertical valley wall. Options for stabilizing the 10 m high cut bank, while technically feasible, cannot be economically justified, and would require extensive in-stream work which would likely not get environmental approval.

Opportunities for trail realignment include using a retaining wall to shift the existing granular trail into the slope and upgrading the existing unmaintained trail.

3.2.1 Option 1 Short Radius Trail with Retaining Wall

By introducing a short radius curve into the existing trail alignment and construction of a short retaining wall in the slope, the trail can be set back a safe distance from the valley wall. For this option, the retaining wall would be in the order of 1.5 m high and 8 m long. Tie-in to the existing trail would form a continuous grade of approximately 3% rising to the south, as shown in **Figure 13**.



Figure 13 Site 2 - Option 1: Local Trail Realignment – Short Wall

While this option addresses the immediate need to preserve the existing access and improve safety for trail users, it does not address the long-term stability of the actively eroding valley wall.

3.2.2 Option 2 Long Radius Trail with Retaining Wall

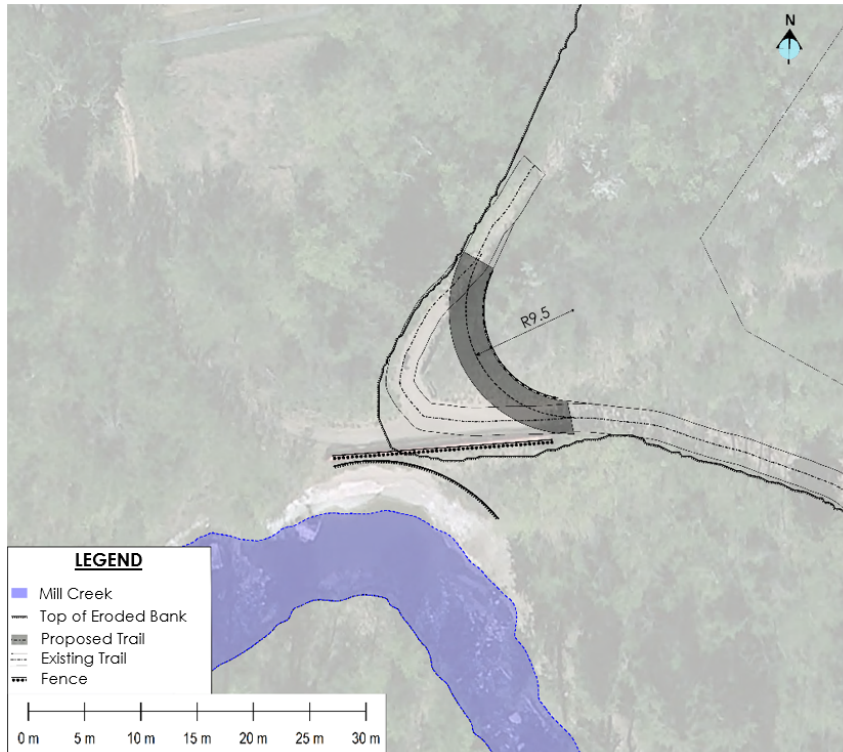

Figure 14 Site 2 - Option 2: Local Trail Realignment – Long Wall

Similar to option 1, but with a longer radius curve, the trail can be set back further from the valley wall. For this option, the retaining wall would be in the order of 2 m high and 16 m long. Tie-in to the existing trail would form a continuous grade of approximately 3.5% rising to the south as shown in **Figure 14**.

While this option also addresses the immediate need to preserve the existing access and improve safety for trail users, it does not address the long-term stability of the actively eroding valley wall.

3.2.3 Option 3 Upgrade Existing Unmaintained Trail

An existing unmaintained trail can be upgraded to granular width to avoid the eroding valley wall. This major trail realignment would take users up a steep slope, across the old Whyte Avenue roadway right of way, then back down again to tie into the existing trail as shown in **Figure 15**. Although tie-in of the north portion is relatively simple with favorable grades, the south portion must traverse an old landslide scarp which would require placement of fill to attain reasonable grades, or construction of a stairway.

This option provides a significant setback from the actively eroding valley wall and can provide a long service life even if a major slope failure occurs.

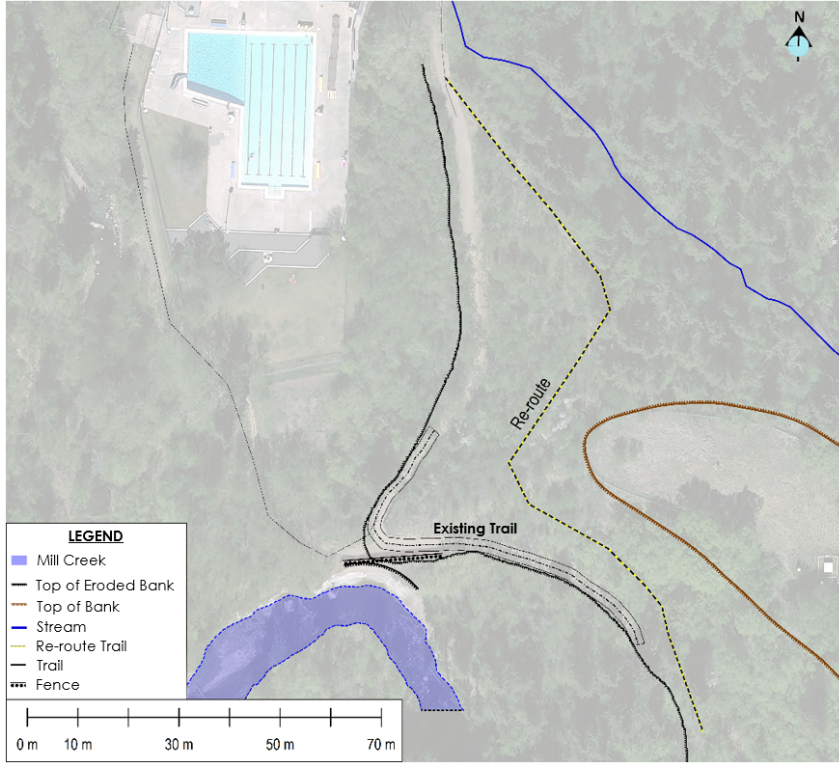

Figure 15 Site 2 - Option 3: Upgrade Existing Unmaintained Trail

Table 2 Site 2 - Option Comparison

Option	Advantage	Disadvantage
1 – Short Radius trail realignment	<ul style="list-style-type: none"> • Unloads potential slide area • Improves sight lines • Smooth trail profile on reasonable grade • Only shrubs are cleared, no trees • Requires only short retaining wall 	<ul style="list-style-type: none"> • Work near underground utilities • Requires construction of short retaining wall
2 – Long Radius trail realignment	<ul style="list-style-type: none"> • Unloads potential slide area • Improves sight lines • Only shrubs are cleared, no trees 	<ul style="list-style-type: none"> • Work near underground utilities • Requires construction of 2 m high retaining wall • Relatively large volume of material to be hauled off site
3 – Upgrade unmaintained	<ul style="list-style-type: none"> • Bypass problem area • Accommodates potential failure of high bank 	<ul style="list-style-type: none"> • Grades are very poor • Clearing of trees • Close unmaintained leading to west side of pool • Ramp fill on south slide crest

3.3 SITE 3

Because the trail is pinched between a steep valley wall, the eroding bank, and close proximity to Bridge 207, options for rehabilitation are limited to trail realignment and restoration of the existing trail by reconstruction of the eroding bank.

3.3.1 Option 1 Minor Trail Realignment

The granular trail can be realigned slightly east into the floodplain forest. This option involves introduction of a slight horizontal deflection at the end of Bridge 207, removal of several mature trees, and tying into the existing granular trail beyond the erosion area as shown in **Figure 16**. Because the trail traverses the floodplain, vertical grades are relatively flat, so salvage of fill from the existing trail will be required.

Reclamation of the abandoned granular trail will be required so that a vegetation buffer can be re-established between the eroding bank and new trail.

This option will provide a temporary buffer to the eroding bank, but does not address future erosion which can potentially attack the trail further north at the tie in point.

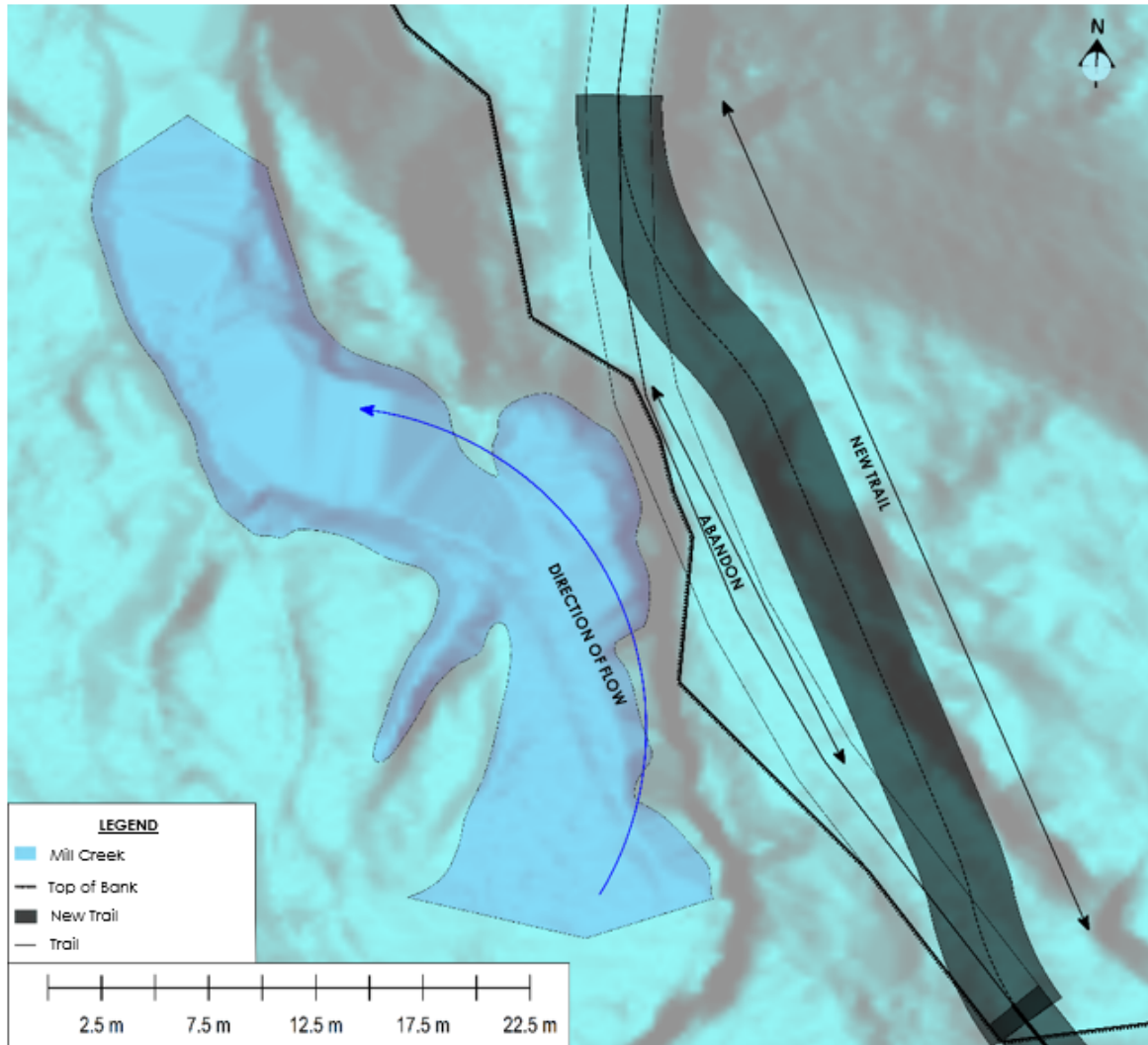

Figure 16 Site 3 - Option 1: Trail Realignment shown on LiDAR Terrain Surface.

3.3.2 Option 2 Major Trail Realignment

The granular trail can be realigned east through the floodplain forest using some of the existing unmaintained trail. This option involves introduction of a significant horizontal deflection at the end of Bridge 207, removal of several mature trees, following the toe of valley wall before tying into the existing granular trail beyond the erosion area as shown in **Figure 17**. Because the trail traverses the floodplain, vertical grades are relatively flat, but import of fill and salvage of fill from the existing trail would be required.

Mill Creek Ravine Park Trail Rehabilitation

Site Assessment & Design Analysis Report

Introduction of a horizontal deflection in the alignment will limit sight lines and reclamation of the abandoned granular trail will be required so that a vegetation buffer can be re-established between the eroding bank and new trail.

This option will provide a temporary buffer to the eroding bank, but does not address future erosion which can potentially attack the trail further north at the tie in point.

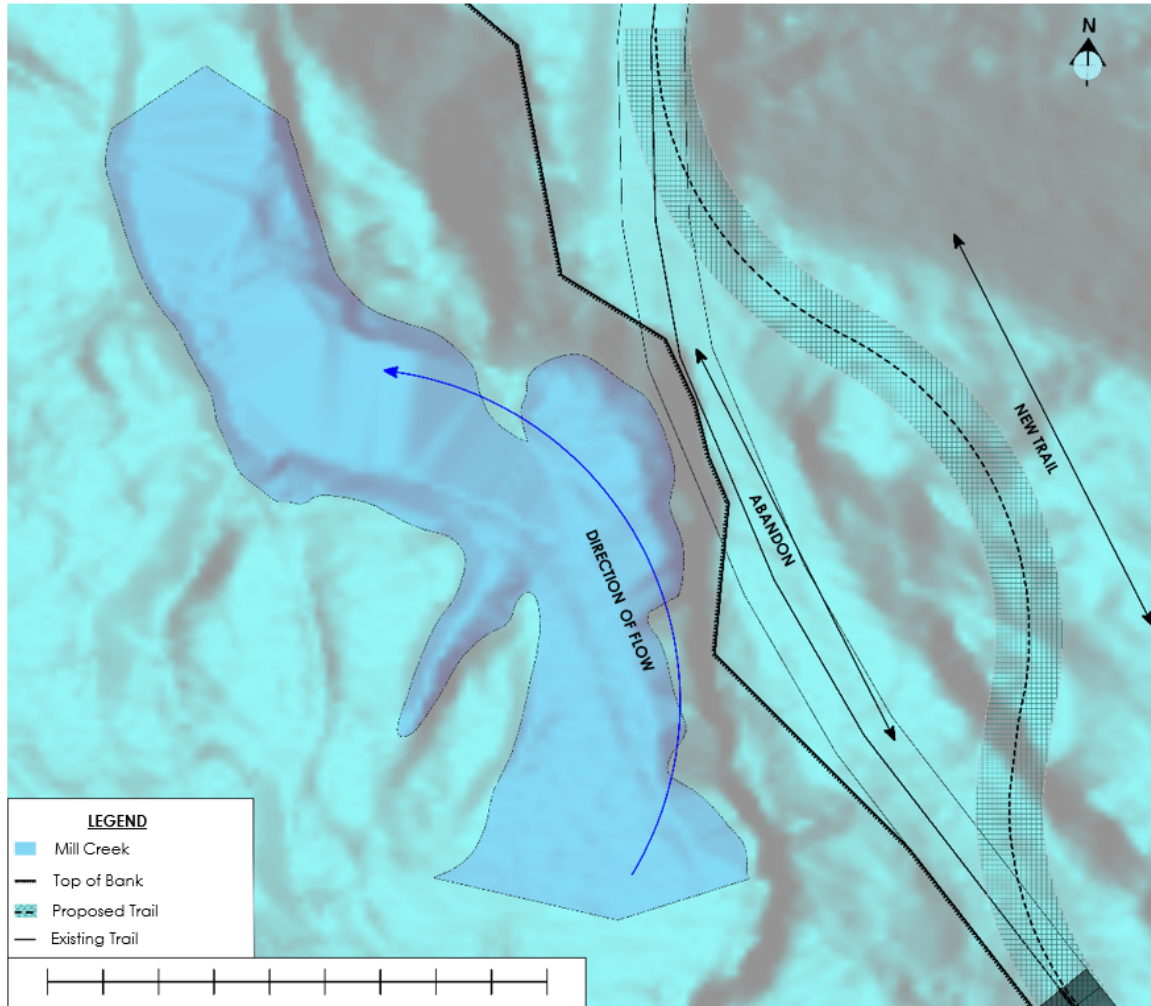

Figure 17 Site 3 - Option 2: Major Trail Realignment

3.3.3 Option 3 Rehabilitation of the Existing Trail and Creek Bank Restoration

To ensure long-term integrity of the trail, the creek bank should be armored to prevent further erosion. Since the erosion encroachment into the trail is currently limited to about 6 m, bank restoration works can be incorporated into trail reconstruction. Several methods of bank restoration are available at this site, including use of heavy rock riprap, bioengineering techniques, and combinations of both.

Mill Creek Ravine Park Trail Rehabilitation

Site Assessment & Design Analysis Report

This option, shown in **Figure 18**, salvages all the existing granular trail and preserves existing sight lines, but requires some in-stream work. A short length of handrail may be required to preserve pedestrian safety adjacent to the top of bank.

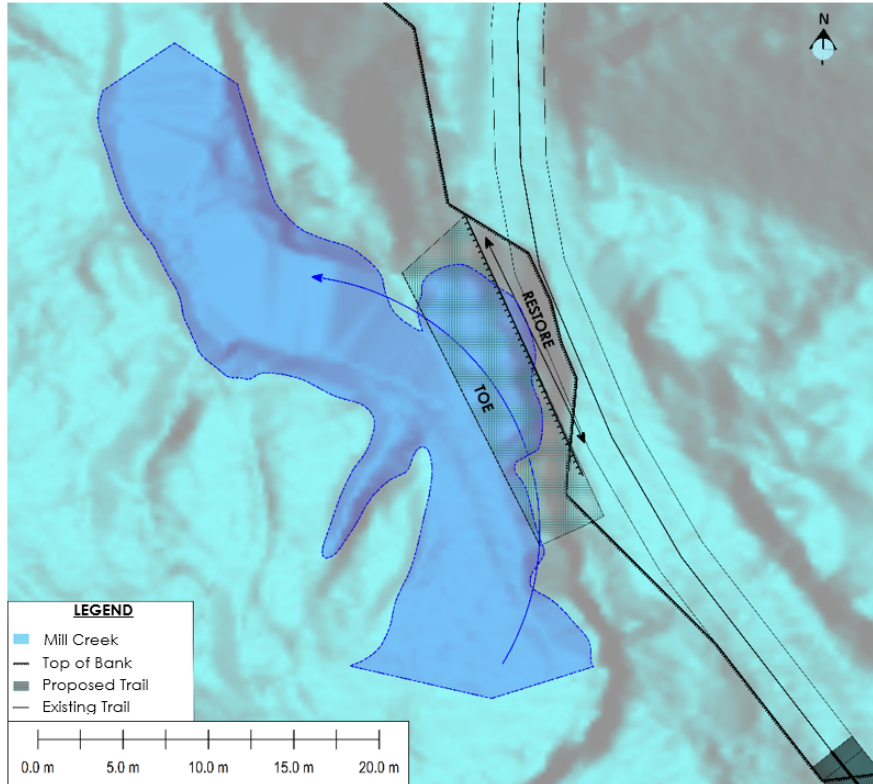

Figure 18 Site 3 - Option 3: Bank Restoration

Table 3 Site 3 Option Comparison

Option	Advantage	Disadvantage
1 – minor trail realignment	<ul style="list-style-type: none"> • Reuses portion of existing trail • Minimal tree removal • No in-stream work 	<ul style="list-style-type: none"> • Doesn't address erosion issue
2 – major trail realignment	<ul style="list-style-type: none"> • No in-stream work • Uses existing unmaintained • Large buffer to existing trail 	<ul style="list-style-type: none"> • Sight lines are poor • New construction • Several large trees need to be removed • Abandons significant length of trail • Doesn't address erosion issue

3 – creek bank restoration a) Riprap armor b) Bioengineering	<ul style="list-style-type: none"> • Permanent and robust • Retains existing sight lines • No trees removed 	<ul style="list-style-type: none"> • Environmental approvals may be difficult and take a long time • Needs rail adjacent to creek
--	--	---

3.4 PREFERRED CONCEPTS

In consultation with the City and in consideration of constructability, costs and environmental impacts, the following concepts are recommended for further development.

3.4.1 Site 1

Option 2 can be optimized to provide favorable grade lines with minimal new construction and removal of mature trees. The final alignment will depend upon taking advantage of terrain around an existing slide scarp and avoiding as many mature trees as possible. Alignment B on **Figure 11** appears to accomplish both goals while providing reasonable sight lines and an adequate setback from the eroding bank. Option 2 is recommended for further development.

Construction access will be from Connors Road, and contractor laydown can be accommodated at the site.

3.4.2 Site 2

Option 3 provides very poor vertical grade line and either requires fill to be placed at the head of an old slide, or construction of stairs down the slide scarp, neither of which are desirable. Options 1 and 2 require similar effort to construct, but Option 2 provides greater setback from the eroding bank; therefore Option 2 is recommended for further development.

Option 2 can be refined by balancing the required slope cut with retaining wall height, which can be limited by trimming the slope above the wall. The soil mass that will remain between the new trail and old, shown in **Figure 14**, can be trimmed and revegetated to provide a continuous safety buffer against the eroding bank, and to block access to the unmaintained trail leading behind Mill Creek Pool. Although the proposed retaining wall is relatively short, it must be designed by a qualified geotechnical engineer.

Construction access and contractor laydown can be accommodated at Mill Creek Pool parking area.

3.4.3 Site 3

Because erosion of the creek bank is an on-going issue, and site configuration is such that the trail cannot be diverted around the erosion site, bank restoration is recommended. Option 3, shown on **Figure 17** should be designed to restore the trail to its original width and prevent further bank erosion. The choice of heavy rock riprap, bioengineering techniques, or a combination of methods, can be optimized in final design. Option 3 is recommended for further development.

A wooden handrail should be installed at the edge of trail to prevent direct access to the creek and provide a safety barrier for cyclists.

Since new material will have to be hauled to Site 3, construction access and contractor laydown can be accommodated at the intersection of 78 Avenue at 93rd Street.

3.5 ENVIRONMENTAL

Please refer to the Environmental report for further detail.

3.6 OPINION OF PROBABLE COST

See **Appendix A**

3.7 CONCEPTUAL CONSTRUCTION SCHEDULE

Site 1, can be constructed any time from late summer through to freeze up. Construction must avoid the migratory bird restriction, but this can be worked around by clearing the proposed route prior to the restricted period, typically in late fall or winter. Construction must also avoid frozen conditions and the risk of placing frozen fill which would result in excessive settlement or instability.

Similar to Site 1, Site 2 can be constructed any time from late summer through to freeze up. Restriction from migratory birds is not as much of a concern because of lack of tree clearing and this concern can be alleviated by a simple bird nest sweep prior to construction. Work should be scheduled to be completed early enough in the growing season to allow for successful reclamation of any restored topsoil areas.

Because of in-stream work, construction at Site 3 will be restricted by regulatory agencies and their opinion on changes to fish habitat, although there are no fish present. The preferred time period would be in the fall when the creek is almost dry. Construction can also proceed in winter conditions since granular fill will be used for bank and trail restoration.

APPENDIX A
OPINION OF PROBABLE COST

Mill Creek Ravine Trail Rehabilitation Construction Cost

2-Feb-18
1161 106255
CLASS D

ITEMS	Estimated Cost	Comments
1.0 SITE #1	<u>\$27,400.00</u>	
1.1 Rehab Trees/Top soil and seed	\$4,700.00	<i>includes rehab of old trail and adjacent to new trail</i>
1.2 Granular Trail	\$12,700.00	<i>includes compaction and granular fill</i>
1.3 Grading	\$10,000.00	
1.4 Tree clearing	\$4,100.00	
1.5 Contingency	\$4,200.00	@15%
2.0 SITE #2	<u>\$75,500.00</u>	
2.1 Rehab Trees/Top soil and seed	\$4,500.00	<i>includes rehab of old trail and adjacent to new trail</i>
2.2 Granular Trail	\$11,700.00	<i>includes compaction and granular fill</i>
2.3 Grading	\$10,000.00	
2.4 Retaining Wall	\$48,000.00	
2.5 Tree Clearing	\$1,300.00	
2.6 Contingency	\$11,350.00	@15%
3.0 SITE #3	<u>\$31,900.00</u>	
3.1 Rehab Trees/Top soil and seed	\$1,500.00	
3.2 Granular Trail	\$7,800.00	<i>includes compaction and granular fill</i>
3.3 Grading	\$5,000.00	
3.4 Crused granular	\$5,650.00	@55.71m ³
3.5 Riprap	\$11,450.00	@187.49m ³
3.6 Tree Clearing	\$500.00	
3.7 Contingency	\$4,875.00	@15%
ESTIMATED CONSTRUCTION	<u>\$102,900.00</u>	<i>GST not included</i>

APPENDIX 3

Rare Plant Survey

**Mill Creek Ravine Early and Late
Season Rare Plant Survey -
June and August 2016**

September 8, 2016

File: 20163745

Olivier Le Tynevez-Dobel
Project Manager, Landscape Design
City of Edmonton
CN Tower, 10004, 104 Avenue NW
Edmonton AB
T5J 2R7

**Re: MILL CREEK RAVINE EARLY AND LATE SEASON RARE PLANT SURVEY - JUNE AND
AUGUST 2016**

Dear Mr. Le Tynevez-Dobel:

1 INTRODUCTION

The City of Edmonton retained Associated Engineering to complete a rare plant survey at three locations within Mill Creek Ravine Park (the Study Area). Trail realignment and naturalization activities are proposed at these locations to improve trail safety where bank erosion and slope instability are present along trails at three sites.

The survey included a desktop assessment to identify focus areas and key habitats, and two one-day field surveys, conducted on June 21 and August 8, 2016, to identify the presence of early and late season rare species within the study area. This report describes the results of the survey.

2 METHODS

2.1 DESKTOP ASSESSMENT

The desktop assessment included a review of background information to plan the field survey. The methods for the desktop assessment were as follows:

- Stratify the study area into habitat types using satellite imagery.
- Conduct a search of available rare plant information for the study area using the Alberta Conservation Information Management System (ACIMS) rare plant database.
- Create a list of rare plant species and rare plant communities likely to be encountered based on the habitat types identified in the study area.
- Plan a field survey for rare plants and rare plant communities based on the information collected.



September 8, 2016
Olivier Le Tynevez-Dobel
City of Edmonton
- 2 -

An ACIMS database search of all element occurrence data was completed prior to the field survey to determine if any past observations of plant species or communities of special concern were made in the study area (ACIMS 2015). The search area included a 3-km radius from the study area to capture rare element occurrences in adjacent areas that have similar habitat (Appendix A).

The ACIMS assigns a conservation rank to each plant species on a global, national, and subnational scale of 1 to 5 (Table 2-1). The rank is based on rarity of a species or community and risk of extirpation. Those species that current data suggest may be rare are placed on a tracking or watch list (i.e., usually species ranked S3 or lower).

Search results provided a list of rare species with potential to be encountered in the study area. In addition to a targeted area search, a list of all rare element occurrences (e.g., rare vascular plants, bryophytes, lichens, and communities) found in the Central Parkland natural subregion, in which the study area is located, was reviewed to evaluate all possible rare element occurrences. Key identification features, habitats, phenology, and illustrations of the species likely to be encountered were studied prior to the field survey.

The ACIMS database contains information on locations of rare plants and rare plant communities that were previously recorded. However, it does not provide detailed information on the likelihood of occurrences in an area. Thus, a field survey was required to capture and record any new element occurrences of rare species. While this review is conducted for the most likely rare species to be encountered, the field survey includes identification of all plant species encountered in the field.

2.2 INITIAL SITE VISIT – CITY OF EDMONTON

An on-site meeting attended by the City of Edmonton Project Manager, Olivier Le Tynevez-Dobel and AE rare plant surveyor, Kristen Andersen, to review the proposed trail upgrades and study area boundaries. Three sites were visited as shown on Figure 2-1. At each site, trail work will occur on only one side of Mill Creek. Therefore, the study area included Mill Creek and adjacent land where trail work is planned. The study area extended approximately 30 metres (m) from the trails to be relocated and 5 m from the trails where activities will be limited to closure and naturalization. Study area boundaries are shown in Figures 3-1, 3-2, and 3-3.



September 8, 2016
Olivier Le Tynevez-Dobel
City of Edmonton
- 3 -

Table 2-1
Species conservation ranks*

Rank	Definition
SX/GX	<ul style="list-style-type: none"> • Taxon is believed to be extirpated from the province • Not located despite intensive searches of historical sites and other appropriate habitat • Virtually no likelihood that it will be rediscovered
SH/GH	<ul style="list-style-type: none"> • Known from only historical records but still some hope of rediscovery • Evidence that the taxon may no longer be present but not enough to state this with certainty
S1/G1	<ul style="list-style-type: none"> • Known from five or fewer occurrences or especially vulnerable to extirpation because of other factor(s)
S2/G2	<ul style="list-style-type: none"> • Known from 20 or fewer occurrences or vulnerable to extirpation because of other factors
S3/G3	<ul style="list-style-type: none"> • Known from 100 or fewer occurrences, or somewhat vulnerable due to other factors, such as restricted range, relatively small population sizes, or other factors
S4/G4	<ul style="list-style-type: none"> • Apparently secure • Taxon is uncommon but not rare • Potentially some cause for long-term concern due to declines or other factors
S5/G5	<ul style="list-style-type: none"> • Secure - taxon is common, widespread, and abundant
SNR/GNR	<ul style="list-style-type: none"> • Element not yet ranked
SU/GU	<ul style="list-style-type: none"> • Currently “unrankable” due to lack of information or substantially conflicting information about status or trends
SNA/GNA	<ul style="list-style-type: none"> • Not applicable • A conservation status rank is not applicable because the community is not a suitable target for conservation activities
S#S#/G#G#	<ul style="list-style-type: none"> • Ranks can be combined to indicate a range. Example - S2S3 = may be between 6 and 80 occurrences throughout Alberta but the exact status is uncertain • Ranges cannot skip more than one rank (e.g., SU is used rather than S1S4) • Combined ranks indicate a larger margin of error than ranks assigned a “?” qualifier (see below)
S#/?/G#/?	<ul style="list-style-type: none"> • Inexact numeric rank • Applied when a specific rank is most likely appropriate but for which some conflicting information or unresolved questions remain. Example - S2? believed to be 6 - 20 occurrences but some uncertainty



September 8, 2016
Olivier Le Tynevez-Dobel
City of Edmonton
- 4 -

2.3 FIELD SURVEY

The methods for field survey were as follows:

- Confirm the boundaries of the habitat types within the study area.
- Document the presence of any rare plants observed within the study area.
- Compile a list of all plant species within the study area.
- Recommend mitigation measures for future projects and construction, if rare plants are found.

The rare plant survey followed the Alberta Native Plant Council (ANPC) Guidelines for Rare Vascular Plant Surveys in Alberta (2012). A field survey was completed in early and late summer (June and August 2016) to capture early and late flowering species at their respective flowering times (phenology). Flowering and/or seeding can be important diagnostic features used to complete positive identification of rare species (ANPC 2012).

The study area was investigated using a floristic survey method with transect searches. Transect searches involved walking parallel transects within a site. Unique or special landscape features, such as microhabitats, ephemeral habitats, wet areas, or transition zones, were given special attention. These areas tend to be important habitats for rare plants (Kershaw et al. 2001), as rare plants and rare plant communities are usually closely linked with soil moisture, nutrient level, and substrate type. Effectively, a combination of a meander and transect survey was performed to increase the chances of capturing any rare plant species within the study area (ANPC 2012). Each site was evaluated for the presence of rare plant communities.

Plants were identified using a hand lens and appropriate taxonomic keys (Moss et al. 1983, Johnson et al. 1995, Kershaw et al. 2001). Locations of existing trails and rare plant species were mapped using GPS coordinates and ArcGIS.

P:\01\03745\00_Mill_Creek_Rare_Plant_Survey\GIS\02_00_Data_Collection_Field_Data\GIS\RarePlantStudy.mxd
DATE: 9/2/2016

IF NOT 25 mm ADJUST SCALES
25 mm
SCALE(S) SHOWN ARE INTENDED FOR TABLOID (11X17) SIZE DRAWINGS UNLESS NOTED OTHERWISE

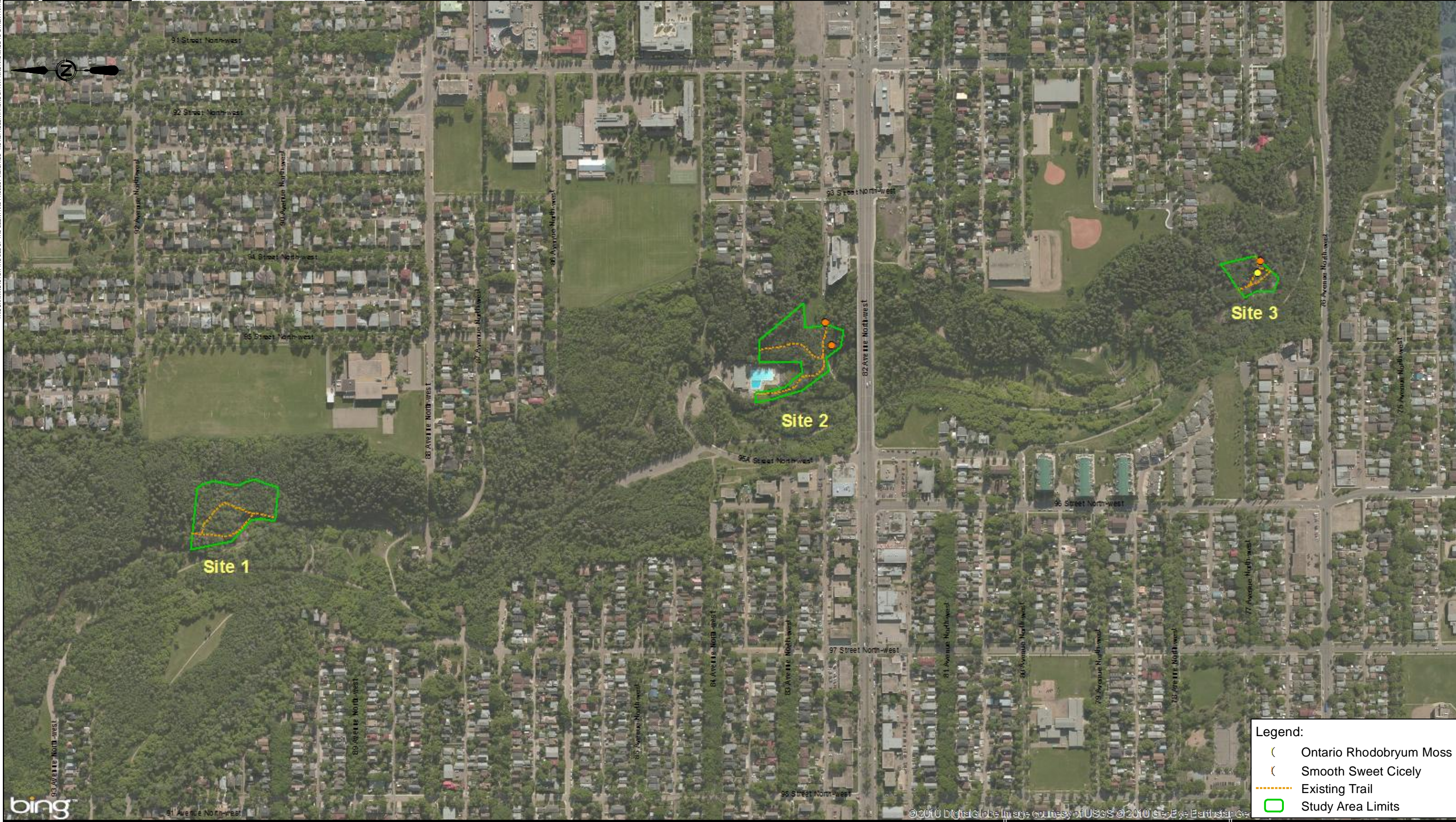

Legend:

- () Ontario Rhodobryum Moss
- () Smooth Sweet Cicely
- Existing Trail
- Study Area Limits



AE PROJECT No. 2016-3745
 SCALE 1:5,000
 PROJECTION 3TM114
 DATE 2016 SEPTEMBER
 REV
 DESCRIPTION ISSUED FOR REPORT

FIGURE No. 2-1
 MILL CREEK RAVINE
 RARE PLANT SURVEY
 ENVIRONMENTAL
 STUDY AREAS & PLANT LOCATIONS
 ALL SITES



September 8, 2016
Olivier Le Tynevez-Dobel
City of Edmonton
- 6 -

3 RESULTS

3.1 DESKTOP ASSESSMENT

3.1.1 Landscape Stratification

There are two habitat types (forest and aquatic) within the study area. Forested habitat comprises all areas except for the portion within the banks of the Mill Creek, which is aquatic habitat.

The forested habitat within the study area is characterized as a natural deciduous treed area. A recreational facility at Site 2 borders the site creating an interface of forest and mowed lawn. A species list is provided in Appendix B.

The aquatic habitat was investigated at Site 1 and Site 3 where observation from the banks of Mill Creek was possible. Safe access to the aquatic habitat was not possible at Site 2. No vascular plant species were observed within Mill Creek. Algae were observed in limited locations and extent.

3.1.2 ACIMS Query and Results

The ACIMS database search produced 14 element occurrences (Appendix A) that included seven species (i.e., two vascular species and five bryophyte species). No rare plant community element occurrences were found within the search area. None of the element occurrences identified in the database search were actually located within the study area. One of these species comprised five of the 14 element occurrences and was found at two sites in the study area during the field survey as described below.

3.2 FIELD SURVEY

3.2.1 Rare Species

Of the species encountered within the study area, one vascular plant species and one bryophyte species was determined to be rare and tracked on the Alberta List of Tracked and Watched Elements (ACIMS 2015). The vascular species is smooth sweet cicely (*Osmorhiza longistylis*) and the bryophyte species is Ontario rhodobryum moss (*Rhodobryum ontariense*). Table 3-1 lists both species and their provincial and global rankings. Smooth sweet cicely was found in two locations at Site 2 and one location at Site 3. Ontario rhodobryum moss was found in one location at Site 3.

During the early season rare plant survey, three individual plants of smooth sweet cicely were observed. At Site 2, two individual plants of smooth sweet cicely were observed at the location shown on Figure 3-2. At Site 3, one individual plant was observed at the location shown on Figure 3-3. During the late season rare



September 8, 2016
Olivier Le Tynevez-Dobel
City of Edmonton
- 7 -

plant survey, an addition patch of approximately 50 individual smooth sweet cicely plants were observed at Site 2, at the location shown on Figure 3-2.

GPS coordinates were collected for each location that smooth sweet cicely was found. Coordinates are provided below and are based on the coordinate system commonly used for the City of Edmonton (3TM 114) as follows:

- Site 2: 34930 m East, 5931858 m North
- Site 2: 34961 m East, 5931866 m North
- Site 3: 35048 m East, 591259 m North

GPS coordinate data that were initially collected for each location of smooth sweet cicely during the June survey did not plot correctly due to heavy tree canopy. A second site visit was made on July 8, 2016 to re-collect GPS data with equipment capable of greater accuracy (+/- 1 metre). During this site visit, smooth sweet cicely was no longer found at Site 3 and disturbed ground was observed in its former location.

During the August survey, approximately 75 to 100 individual plants of Ontario rhodobryum moss were observed in a patch at one location at Site 3, shown on Figure 3-3. GPS coordinates collected for the Ontario rhodobryum moss are based on the 3TM 114 coordinate system are provided below:

- Site 3: 35032 m East, 5931263 m North

Photographs of the rare plants at each site are provided in Appendix C. No rare plant communities were observed during field surveys.

Table 3-1
Rare plant species within the study area

Scientific Name	Common Name	Habitat Type Where Found	Alberta Rank*	Global Rank*	Status
<i>Osmorhiza longistylis</i>	smooth sweet cicely	Forest	S3	G5	Somewhat vulnerable; globally secure
<i>Rhodobryum ontariense</i>	Ontario rhodobryum moss	Forest	S1S2	G5	vulnerable; globally secure

Note: *For definitions of Alberta (S) and global (G) rankings, refer to Table 2-1 of Section 2.1.

Source: ACIMS 2015





September 8, 2016
Olivier Le Tynevez-Dobel
City of Edmonton
- 8 -

Observation and population details for smooth sweet cicely and Ontario rhodobryum moss will be provided on the ACIMS Rare Native Plant and Lichen Survey form (Appendix D) and will be submitted to ACIMS for updating element occurrence lists.

3.2.2 Invasive Species

Although an extensive weed survey was not conducted as part of this rare plant survey, the presence of any exotic or invasive species encountered was documented. Appendix B includes a list of species and their status as a native or exotic species. A list of noxious weeds observed is provided in Table 3-2.

Table 3-2
Noxious weed species within the study area

Scientific Name	Common Name	Site 1	Site 2	Site 3
<i>Arctium minus</i>	common burdock	Yes	Yes	Yes
<i>Cirsium arvense</i>	Canada thistle	Yes	Yes	Yes
<i>Silene latifolia</i>	white cockle	No	Yes	No
<i>Sonchus arvensis</i>	perennial sow-thistle	Yes	Yes	Yes
<i>Tanacetum vulgare</i>	common tansy	Yes	No	Yes
<i>Tripleurospermum inodorum</i>	scentless chamomile	Yes	No	No
<i>Linaria vulgaris</i>	common toadflax	No	Yes	No

THIS DRAWING IS FOR THE USE OF THE CLIENT AND PROJECT INDICATED - NO REPRESENTATIONS OF ANY KIND ARE MADE TO OTHER PARTIES

P:\2016\2016-09-01_Mill_Creek_Rare_Plant_Inventory_Scientist\02_00_Data_Collection_Field_Data\GIS\RarePlantStudy.mxd
DATE: 9/9/2016



Legend:

- (Ontario Rhodobryum Moss
- (Smooth Sweet Cicely
- Existing Trail
- Study Area Limits

bing™

© 2010 DigitalGlobe



AE PROJECT No.	2016-3745
SCALE	1:1,000
PROJECTION	3TM114
DATE	2016 SEPTEMBER
REV	
DESCRIPTION	ISSUED FOR REPORT

FIGURE No. 3-1
MILL CREEK RAVINE RARE PLANT SURVEY
ENVIRONMENTAL STUDY AREAS & PLANT LOCATIONS SITE 1

P:\2016\2016-09-01_Mill_Creek_Rare_Plant_Survey_PlanStudy.mxd
DATE: 9/9/2016

IF NOT 25 mm ADJUST SCALES
25 mm
SCALE(S) SHOWN ARE INTENDED FOR TABLOID (11X17) SIZE DRAWINGS UNLESS NOTED OTHERWISE



Legend:

- (Ontario Rhodobryum Moss
- (Smooth Sweet Cicely
- Existing Trail
- Study Area Limits

bing™

© 2010 DigitalGlobe



AE PROJECT No.	2016-3745
SCALE	1:1,000
PROJECTION	3TM114
DATE	2016 SEPTEMBER
REV	
DESCRIPTION	ISSUED FOR REPORT

FIGURE No. 3-2
MILL CREEK RAVINE RARE PLANT SURVEY
ENVIRONMENTAL STUDY AREAS & PLANT LOCATIONS SITE 2

THIS DRAWING IS FOR THE USE OF THE CLIENT AND PROJECT INDICATED - NO REPRESENTATIONS OF ANY KIND ARE MADE TO OTHER PARTIES

P:\2016\2016-09-01_Mill_Creek_Rare_Plant_Survey_PlanStudy.mxd
DATE: 9/9/2016

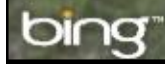

© 2010 DigitalGlobe

Legend:

- (Ontario Rhodobryum Moss
- (Smooth Sweet Cicely
- Existing Trail
- Study Area Limits



AE PROJECT No.	2016-3745
SCALE	1:500
PROJECTION	3TM114
DATE	2016 SEPTEMBER
REV	
DESCRIPTION	ISSUED FOR REPORT

FIGURE No. 3-3
MILL CREEK RAVINE RARE PLANT SURVEY
ENVIRONMENTAL STUDY AREAS & PLANT LOCATIONS SITE 3



September 8, 2016
Olivier Le Tynevez-Dobel
City of Edmonton
- 12 -

4 MITIGATION, RECOMMENDATIONS, AND DISCUSSION

Mitigation measures are recommended to: (1) minimize disturbance of existing native vegetation communities that have potential to provide rare plant habitat; and (2) protect and preserve the rare species found within the study area. Construction and traffic in these areas should be avoided or minimized.

The Mill Creek Ravine Park Trail Project footprint is not expected to overlap with the location of smooth sweet cicely found at Site 2 and Site 3. Therefore, disturbance that may cause impacts on these locations are not expected to occur. It is recommended to include GPS coordinates of each location into planning and design of the project for avoidance. Should construction occur within 5 m of this species, it is recommended that temporary fencing be installed during construction to ensure no impacts.

If construction cannot be planned away from the locations of smooth sweet cicely, the City can opt to carefully dig up and transplant into an adjacent area of similar habitat that will not be disturbed. In this case, ongoing monitoring of the transplant success of the population should be undertaken to ensure the species is thriving in the new location. However, this plant species, although ranked as S3, is also considered globally secure. Transplanting is a practice implemented primarily for plant species designated as S1/S2 or designated as S3 and not globally secure.

Ontario rhodobryum moss is located between the main trail and a secondary trail. Due to its proximity to the existing trails there is the potential for disturbance of this moss. Although Ontario rhodobryum moss is ranked as S1/S2, transplanting the species is not recommended due to limited research on the survival rates of transplanted moss species. It is recommended to use the same avoidance methodology for Ontario rhodobryum moss as the smooth sweet cicely. GPS coordinates of the location should be included in the planning and design of the project for avoidance. Should construction occur within 5 m of this species, it is recommended that temporary fencing be installed during construction to ensure no impacts.

The spread of any noxious weeds should be limited or controlled in order to comply with the *Weed Control Act* (S.A. 2008, c. W-5.1) and to preserve and minimize disturbance to native vegetation and the three rare plant species within the study area. Taking precautionary measures during construction or any future disturbance within the study area (e.g., removing all soil and vegetative debris from construction equipment or vehicles before entering and leaving the site) will avoid or limit the introduction or spread of weed species from one area to another.



Associated
Engineering

GLOBAL PERSPECTIVE.
LOCAL FOCUS.

September 8, 2016
Olivier Le Tynevez-Dobel
City of Edmonton
- 13 -

5 CLOSURE

Associated Engineering appreciates the opportunity to assist with this project. Please do not hesitate to contact Kristen Andersen (780-446-5803) or Sandra Meidinger (780-451-7666) should you have any questions regarding this report.

Yours truly,

Reviewed by:

Kristen Andersen, B.Sc., PWS, CPESC
Senior Environmental Scientist

Sandra Meidinger, P. Biol., R.P.Bio.
Regional Manager





September 8, 2016
Olivier Le Tynevez-Dobel
City of Edmonton
- 14 -

REFERENCES

Alberta Native Plant Council (ANPC). 2012. Guidelines for Rare Vascular Plant Surveys in Alberta – 2012 Update. <http://anpc.ab.ca/wp-content/uploads/2015/01/Guidelines-For-Rare-Plant-Surveys-in-AB-2012-Update.pdf> (accessed May 26, 2015).

Alberta Conservation Information Management System (ACIMS). 2015. Online data accessed June 17, 2016. Alberta Environment and Sustainable Resource Development, Edmonton, Alberta.

Johnson, D, L. Kershaw, A. MacKinnon, and J. Pojar. 1995. *Plants of the Western Boreal Forest: Alberta, Saskatchewan, and Manitoba Boreal and Aspen Parkland*. Lone Pine Publishing, Edmonton, Alberta. 392 pp.

Kershaw, L., J. Gould, D. Johnson, and J. Lancaster. 2001. Rare Vascular Plants of Alberta. University of Alberta Press, Edmonton, AB; and Nat. Resour. Can, Can. For. Serv., North. For. Cent. Edmonton, AB.

Moss, E.H. 1983. *Flora of Alberta*. Second Edition. Edited by J.G. Packer. University of Toronto Press.

Weed Control Act. S.A. 2008, c. W-5.1.

Appendix A – ACIMS Species within 3Km Radius

Growth Form	Scientific Name (ACIMS)	Common Name (ACIMS)	EO	Element Code (ACIMS)	S Rank	Last Observed	EAST_10T M	NORTH_10T M
Bryophyte	Didymodon fallax	fallacious screw moss	9	NBMUS2C0B0	S2S3	1958-04-23	597778.61	5929902.48
	Entodon concinnus	moss	3	NBMUS2N040	S1S2	1989-06-12	598379.69	5929785.00
	Entodon concinnus	moss	11	NBMUS2N040	S1S2	2003-10-09	601858.27	5931055.50
	Entodon concinnus	moss	9	NBMUS2N040	S1S2	2002-06-01	598379.69	5929823.87
	Entodon schleicheri	Schleicher's silk moss	1	NBMUS2N100	S2S3	2002-06-05	597717.65	5929883.37
	Pohlia atropurpurea	moss	2	NBMUS5S020	S2	1989-05-30	597381.60	5930088.20
	Rhodobryum ontariense	Ontario Rhodobryum moss	4	NBMUS6F020	S1S2	1974-10-02	600955.57	5929308.36
	Rhodobryum ontariense	Ontario Rhodobryum moss	13	NBMUS6F020	S1S2	2006-05-21	598012.30	5930311.94

Growth Form	Scientific Name (ACIMS)	Common Name (ACIMS)	EO	Element Code (ACIMS)	S Rank	Last Observed	EAST_10T M	NORTH_10T M
Vascular	Doellingeria umbellata var. pubens	flat-topped white aster	13	PDASTEHO22	S3	1952-08-16	597658.17	5929529.12
	Osmorhiza longistylis	smooth sweet cicely	10	PDAPI1K060	S3	1999-06-18	599449.51	5929445.00
	Osmorhiza longistylis	smooth sweet cicely	17	PDAPI1K060	S3	2002-07-29	601132.09	5932106.40
	Osmorhiza longistylis	smooth sweet cicely	2	PDAPI1K060	S3	1946-07-12	600186.03	5930985.69



Appendix B – Species List

Scientific Name (ACIMS)	Common Name (ACIMS)	2015 Rank	Origin (ACIMS)	Tracked/ Watched	Site 1	Site 2	Site 3
Acer negundo	Manitoba maple	SU	Native		x	x	x
Sanicula marilandica	snakeroot	S4S5	Native			x	x
Apocynum androsaemifolium	spreading dogbane	S5	Native			x	x
Aralia nudicaulis	wild sarsaparilla	S5	Native		x	x	x
Achillea millefolium	common yarrow	S5	Native			x	x
Arctium minus	common burdock	SNA	Exotic		x	x	x
Bidens cernua	nodding beggarticks	S5	Native		x		x
Cirsium arvense	creeping thistle	SNA	Exotic		x	x	x
Osmorhiza longistylis	smooth sweet cicely	S3	Native	x		x	x
Petasites frigidus var. palmatus	palmate-leaved coltsfoot	S5	Native		x		x
Sonchus arvensis	perennial sow-thistle	SNA	Exotic		x	x	x
Tanacetum vulgare	common tansy	SNA	Exotic		x		x
Taraxacum officinale	common dandelion	SNA	Exotic		x	x	x
Tragopogon dubius	common goat's-beard	SNA	Exotic			x	
Tripleurospermum inodorum	scentless chamomile	SNA	Exotic		x		
Corylus cornuta	beaked hazelnut	S5	Native		x	x	x



Scientific Name (ACIMS)	Common Name (ACIMS)	2015 Rank	Origin (ACIMS)	Tracked/ Watched	Site 1	Site 2	Site 3
Mertensia paniculata	tall lungwort	S5	Native			x	x
Sambucus racemosa	red elderberry	S4	Native				x
Symphoricarpos albus	snowberry	S5	Native		x	x	x
Viburnum edule	low-bush cranberry	S5	Native		x	x	x
Cornus canadensis	bunchberry	S5	Native				x
Cornus stolonifera	red-osier dogwood	S5	Native		x	x	x
Carex peckii	Peck's sedge	S4	Native				x
Carex sprengelii	Sprengel's sedge	S4	Native				x
Elaeagnus commutata	silverberry	S5	Native				x
Shepherdia canadensis	Canada buffaloberry	S5	Native			x	x
Equisetum arvense	common horsetail	S5	Native		x	x	x
Vaccinium myrtilloides	common blueberry	S5	Native		x	x	x
Caragana arborescens	common caragana	SNA	Exotic			x	x
Medicago sativa	alfalfa	SNA	Exotic		x	x	x
Melilotus officinalis	yellow sweet-clover	SNA	Exotic		x	x	x
Trifolium hybridum	alsike clover	SNA	Exotic			x	
Trifolium pratense	red clover	SNA	Exotic		x	x	x



Scientific Name (ACIMS)	Common Name (ACIMS)	2015 Rank	Origin (ACIMS)	Tracked/ Watched	Site 1	Site 2	Site 3
Trifolium repens	white clover	SNA	Exotic		x	x	x
Quercus macrocarpa	burr oak	SNA	Exotic		x	x	x
Ribes hudsonianum	northern black currant	S5	Native			x	
Ribes oxycanthoides	northern gooseberry	S5	Native		x	x	X
Ribes triste	wild red currant	S5	Native		x		x
Allium cernuum	nodding onion	S5	Native			x	x
Maianthemum canadense	wild lily-of-the-valley	S5	Native		x	x	x
Maianthemum stellatum	star-flowered Solomon's-seal	S5	Native		x	x	x
Prosartes trachycarpa	fairybells	S5	Native				x
Chamerion angustifolium	common fireweed	S5	Native			x	x
Picea glauca	white spruce	S5	Native		x	x	x
Plantago major	common plantain	SNA	Exotic		x	x	x
Agrostis stolonifera	redtop	SNA	Exotic			x	
Bromus inermis	smooth brome	SNA	Exotic		x	x	x
Phleum pratense	timothy	SNA	Exotic		x		
Poa pratensis	Kentucky bluegrass	S5	Native		x	x	x
Actaea rubra	red and white baneberry	S5	Native		x	x	x



Scientific Name (ACIMS)	Common Name (ACIMS)	2015 Rank	Origin (ACIMS)	Tracked/ Watched	Site 1	Site 2	Site 3
Anemone canadensis	Canada anemone	S5	Native				x
Anemone cylindrica	long-fruited anemone	S5	Native		x	x	
Thalictrum venulosum	veiny meadow rue	S5	Native		x	x	x
Rhamnus catharticus	common buckthorn	SNA	Exotic		x	x	
Amelanchier alnifolia	saskatoon	S5	Native		x	x	x
Prunus pensylvanica	Pin cherry	S5	Native			x	
Prunus virginiana	choke cherry	S5	Native		x	x	x
Rosa acicularis	prickly rose	S5	Native		x	x	x
Rubus idaeus	wild red raspberry	S5	Native		x	x	x
Rubus pubescens	dewberry	S5	Native				x
Sorbus scopulina	western mountain-ash	S5	Native		x	x	x
Galium boreale	northern bedstraw	S5	Native		x	x	x
Galium triflorum	sweet-scented bedstraw	S5	Native				x
Populus balsamifera	balsam poplar	S5	Native		x	x	x
Populus tremuloides	aspen	S5	Native		x	x	x
Salix lasiandra var. lasiandra	shining willow	S5	Native				x
Linaria vulgaris	common toadflax	SNA	Exotic			x	



Scientific Name (ACIMS)	Common Name (ACIMS)	2015 Rank	Origin (ACIMS)	Tracked/ Watched	Site 1	Site 2	Site 3
Pedicularis labradorica	Labrador lousewort	S5	Native				x
Typha latifolia	common cattail	S5	Native		x		
Urtica dioica	common nettle	S5	Native		x		
Viola canadensis	western Canada violet	S5	Native			x	x
Lonicera dioica	twining honeysuckle	S5	Native		x	x	x
Lonicera involucrata	bracted honeysuckle	S5	Native			x	
Agrimonia striata	agrimony	S4	Native		x	x	x
Campanula rapunculoides	creeping bellflower	SNA	Exotic		x		
Elymus repens	quackgrass	SNA	Exotic		x		
Eurybia conspicua	showy aster	S5	Native			x	x
Heracleum maximum	cow parsnip	S5	Native		x		
Hieracium umbellatum	narrow-leaved hawkweed	S5	Native				x
Impatiens capensis	spotted touch-me-not	S4	Native			x	
Lathyrus ochroleucus	cream-colored vetchling	S5	Native			x	
Pyrola asarifolia	common pink wintergreen	S5	Native				x
Pyrola chlorantha	greenish-flowered wintergreen	S5	Native				x



Scientific Name (ACIMS)	Common Name (ACIMS)	2015 Rank	Origin (ACIMS)	Tracked/ Watched	Site 1	Site 2	Site 3
Senecio eremophilus	cut-leaved ragwort	S5	Native		x	x	x
Silene latifolia	white cockle	SNA	Exotic			x	
Solidago canadensis	Canada goldenrod	SNA	Native		x	x	x
Symphotrichum ciliolatum	Lindley's aster	S5	Native		x	x	x
Vicia americana	wild vetch	S5	Native		x	x	x
Hylocomium splendens	stair-step moss	S5	Native		x		
Pleurozium schreberi	Schreber's moss	S5	Native			x	
Pylaisiella polyantha	moss	S5	Native		x		x
Rhodobryum ontariense	Ontario Rhodobryum moss	S1S2	Native	x			x

Appendix C – Photographs



Photo 1
Smooth Sweet Cicely at Site 2 (June Site Visit)



Photo 2
Smooth Sweet Cicely at Site 2 (June Site Visit)



Photo 3
Smooth Sweet Cicely at Site 3 (June Site Visit)



Photo 4
Smooth Sweet Cicely at Site 3 (June Site Visit)



Photo 5
Smooth Sweet Cicely at Site 2 (August Site Visit)

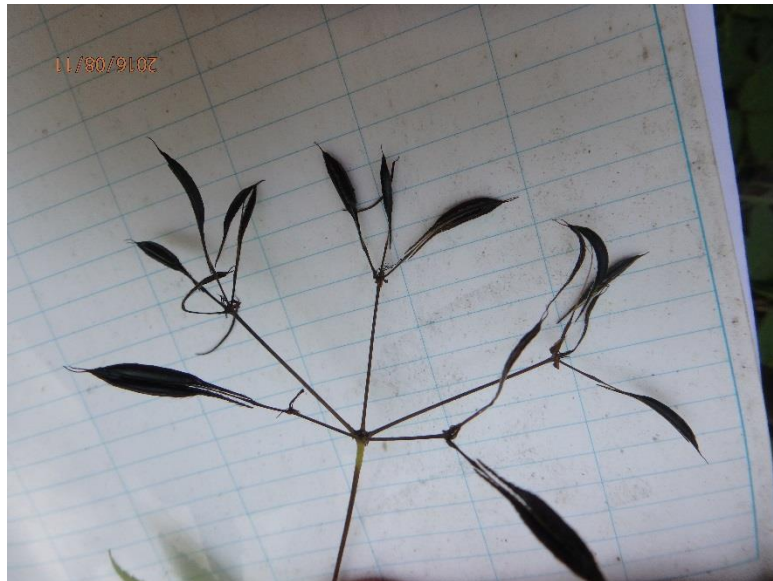

Photo 6
Smooth Sweet Cicely Fruit at Site 2 (August Site Visit)



Photo 7
Patch of Smooth Sweet Cicely Fruit at Site 2 (August Site Visit)



Photo 8
Patch of Smooth Sweet Cicely Fruit at Site 2 (August Site Visit)



Photo 9
Patch of Ontario Rhodobryum Moss at Site 3 (August Site Visit)



Photo 10
Patch of Ontario Rhodobryum Moss at Site 3 (August Site Visit)



Associated
Engineering

GLOBAL PERSPECTIVE.
LOCAL FOCUS.

Appendix D – ACIMS Forms



RECORD #	SPECIES	OBSERVER CONTACT INFO	SURVEY DATE (YYYY-MM-DD)	Type of Survey	TARGET SPECIES	Type of Visit	EO Number	DETERMINED BY	REFERENCES USED	KEY CHARACTERISTICS	SPECIMEN COLLECTED	SPECIMEN DISPOSITION	ACCESSION #	PHOTO TAKEN?	PHOTO FILE NAME	POPULATION SIZE	COUNT OR ESTIMATE?	PHENOLOGY	POPULATION EXTENT	MEASURED OR ESTIMATE
Site2KA	<i>Osmorhiza longistylis</i>	Kristen Andersen, PWS, CPESC Senior Environmental Scientist Associated Environmental Consultants Inc. 500, 9888 Jasper Avenue, Edmonton, AB T5J 5C6 Tel: 780.451.7666 Cel: 780.446.5803 Dir: 587.772.0708 andersenk@ae.ca	6/21/2016	general rare plant	n/a	first	n/a	Kristen Andersen	Moss, E.H. 1983. Flora of Alberta. Second Edition. Edited by J.G. Packer. University of Toronto Press. Kershaw, L., J. Gould, D. Johnson, and J. Lancaster. 2001. Rare Vascular Plants of Alberta. University of Alberta Press, Edmonton, AB; and Nat. Resour. Can, Can. For. Serv., North. For. Cent. Edmonton, AB.	Fruit length (18-22mm), persistent bracts at base of flower clusters.	No	n/a	n/a	Y	O.longistylisSite2-1,O.longistylisSite2-2,O.longistylisSite2-3,O.longistylisSite2-4	2	Count	100% in flower	0.5 m x 0.5 m	Estimate
Site2JW	<i>Osmorhiza longistylis</i>	Jaime Walker, PAg. Environmental Scientist Associated Environmental Consultants Inc. 500, 9888 Jasper Avenue, Edmonton, AB T5J 5C6 Tel: 780.451.7666 Cel: 780.722.7933 Dir: 780.969.6334 walkerj@ae.ca	8/8/2016	general rare plant	n/a	repeat	n/a	Jaime Walker	Moss, E.H. 1983. Flora of Alberta. Second Edition. Edited by J.G. Packer. University of Toronto Press. Kershaw, L., J. Gould, D. Johnson, and J. Lancaster. 2001. Rare Vascular Plants of Alberta. University of Alberta Press, Edmonton, AB; and Nat. Resour. Can, Can. For. Serv., North. For. Cent. Edmonton, AB.	Fruit length (18-22mm), persistent bracts at base of flower clusters.	No	n/a	n/a	Y	O.longistylisSite2-5, O.longistylisSite2-6, O.longistylisSite2-7	50	Estimate	75% vegetative; 25% mature seed	5 m x 3 m	Measured
Site3KA	<i>Osmorhiza longistylis</i>	Kristen Andersen, PWS, CPESC Jaime Walker, PAg. Environmental Scientist Associated Environmental Consultants Inc. 500, 9888 Jasper Avenue, Edmonton, AB T5J 5C6 Tel: 780.451.7666 Cel: 780.969.6334 walkerj@ae.ca	6/21/2016	general rare plant	n/a	first	n/a	Kristen Andersen	Moss, E.H. 1983. Flora of Alberta. Second Edition.	Fruit length (18-22mm), persistent bracts at base of	No	n/a	n/a	Y	O.longistylisSite3-1, O.longistylisSite3-2	1	Count	100% vegetative	n/a	n/a
Site3JW	<i>Rhodobryum ontariense</i>	Jaime Walker, PAg. Environmental Scientist Associated Environmental Consultants Inc. 500, 9888 Jasper Avenue, Edmonton, AB T5J 5C6 Tel: 780.451.7666 Cel: 780.969.6334 walkerj@ae.ca	8/8/2016	general rare plant	n/a	repeat	n/a	Jaime Walker/ Peter Whitehead	Sent to bryologist Peter Whitehead for confirmation. pwhitehead@capeecology.ca	Large 9-13 mm leaves have acute to acuminate toothed tips and are broadest above the middle, with a midrib extending to the leaf tip. Grows in clusters of what appear to be little green "flowers" when moist.	Yes	n/a	n/a	Y	R.ontarienseSite3-3, R.ontarienseSite3-4	75	Estimate	100% vegetative	10 cm x 30cm	Measured

SITE/HABITAT DESCRIPTION	MOISTURE	LIGHT	SLOPE (%)	ASPECT (°)	SUBSTRATE	SITE NAME	DIRECTIONS TO POPULATION	UTM EASTING	UTM NORTHING	GRID ZONE	DATUM	SOURCE	PRECISION (m)	LEGAL LAND DESCRIPTION (ATS)	ELEVATION (m)	CURRENT LAND USE	OWNERSHIP	THREATS TO HABITAT OR POPULATION	COMMENTS
Riparian creek bench, adjacent to Mill Creek in Mill Creek ravine	Hygric	Filterd	30	170	Soil	Site 2	Take trail on east side of Mill Creek Pool the runs north to south, after trail curves to the east 2 individuals are approximately 11 m south the trail, between the trail and Mill creek.	34930	5931858		3TM 114	GPS	(+/-) 1m			Recreation	Community	Public use of ravine trails/ trail maintenance	
Riparian creek bench, adjacent to Mill Creek in Mill Creek ravine	Hygric	Filterd	45	200	Soil	Site 2	Take trail on east side of Mill Creek Pool the runs north to south, after trail curves to the east follow for approximately 43 m. Population is approximately 5m north of the trail.	34961	5931866		3TM 114	GPS	(+/-) 1m			Recreation	Community	Public use of ravine trails/ trail maintenance	
Riparian creek bench, adjacent to Mill Creek in Mill Creek ravine	Hygric	Filterd	5	110	Soil	Site 3	n/a	35048	591259		3TM 114	GPS	(+/-) 1m			Recreation	Community	Public use of ravine trails/ trail maintenance	A second site visit was made on July 8, 2016 to re-collect GPS data with equipment capable of greater accuracy (+/-
Riparian creek bench, adjacent to Mill Creek in Mill Creek ravine	Hygric	Filterd	2	220	Soil	Site 3	From the corner of 93 street and 78 avenue, follow gravel/dirt trail south west into ravine. At trail intersection keep left (south). Follow trail for approximately 65 m. Population is on left (east) approximately 10 m from the main trail and 2 m from secondary dirt trail.	35032	5931263		3TM 114	GPS	(+/-) 1m			Recreation	Community	Public use of ravine trails/ trail maintenance	

APPENDIX 4

Geotechnical Investigation

**Mill Creek Ravine Trail
Rehabilitation**

Geotechnical Report



Prepared for:
City of Edmonton

Prepared by:
Stantec Consulting Ltd.

January 12, 2018

Table of Contents

1.0	INTRODUCTION	1
2.0	SITE DESCRIPTION	2
2.1	SITE 1: MILL CREEK RAVINE TRAIL REALIGNMENT SOUTH OF BRIDGE 277	2
2.2	SITE 2: MILL CREEK RAVINE PARK: DISASTER RECOVERY PROJECT #32	3
2.3	SITE 3: MILL CREEK RAVINE TRAIL REALIGNMENT NEAR SHAMROCK CURLING CLUB	4
3.0	ASSESSMENT	5
3.1	DESKTOP REVIEW	5
3.2	TERRAIN ANALYSIS AT SITE 2	6
3.2.1	Air Photo Review	7
3.2.2	LiDAR Review	7
3.2.3	Summary	7
3.3	SITE INVESTIGATION	8
3.4	LABORATORY TESTING	8
3.5	SUBSURFACE CONDITIONS	9
3.5.1	Site 1	9
3.5.2	Site 2	9
3.5.3	Site 3	10
4.0	DISCUSSION AND RECOMMENDATIONS	11
4.1	WORKING IN GEOHAZARD AREAS	11
4.2	GENERAL TRAIL CONSTRUCTION RECOMMENDATIONS	11
4.3	SITE 1	12
4.4	SITE 2	13
4.4.1	Slope Stability Assessment	14
4.4.2	Analytical Model	14
4.4.3	Stability Analysis Results	15
4.4.4	Other Geotechnical Considerations	17
4.5	SITE 3	19
4.5.1	Options 1 and 2	20
4.5.2	Option 3	20
5.0	SUMMARY	21
6.0	CLOSURE	22
7.0	REFERENCES	23

MILL CREEK RAVINE TRAIL REHABILITATION

LIST OF TABLES

Table 1. Soil Shear Strength Parameters used in Stability Analysis	15
Table 2. Results of Slope Stability Analysis	16
Table 3. Soil Parameters for Retaining Wall Design.....	19

LIST OF FIGURES

Figure 1: Site Location Plan	Appendix B
Figure 2: Site 1 Plan.....	Appendix B
Figure 3: Site 2 Plan.....	Appendix B
Figure 4: Site 3 Plan.....	Appendix B
Figure 5: Slope Map of Site 2.....	Appendix B
Figure 6: Cross Section A (Site 2).....	Appendix B
Figure 7: Cross Section B (Site 2)	Appendix B

LIST OF APPENDICES

APPENDIX A STATEMENT OF GENERAL CONDITIONS	A.1
APPENDIX B FIGURES.....	B.1
APPENDIX C SELECT SITE PHOTOGRAPHS	C.1
APPENDIX D SITE 2 AERIAL PHOTOGRAPHS	D.1
APPENDIX E BOREHOLE RECORD TERMS AND SYMBOLS BOREHOLE RECORDS	E.1
APPENDIX F LABORATORY TEST RESULTS	F.1
APPENDIX G SLOPE STABILITY ANALYSIS RESULTS	G.1

MILL CREEK RAVINE TRAIL REHABILITATION

Introduction
January 12, 2018

1.0 INTRODUCTION

Stantec Consulting Ltd. (Stantec) completed a geotechnical investigation and input into remediation design for three erosion sites along the Mill Creek Ravine Trail System in Edmonton, Alberta. The work was carried out in accordance with Stantec's revised proposal dated March 29, 2017, submitted to the City of Edmonton (the City).

The geotechnical scope of work included:

- Participating in an on-site feasibility meeting with City and Stantec personnel;
- Obtaining approval for field work through the City of Edmonton's Project Request Form;
- Carrying out a desktop study using readily available geology maps, aerial photographs, LiDAR data, and published papers;
- Completing a geotechnical test hole program to assess the subsurface conditions;
- Conducting a laboratory testing program on select soil samples obtained during the test hole investigation program;
- Conducting geotechnical engineering evaluations and analyses for the conceptual remediation options for each of the sites; and,
- Providing a summary of our findings and recommendations for geotechnical considerations for the remediation of each site.

The conceptual design options are described in detail under separate cover in Stantec's Draft Site Assessment and Design Analysis Report, dated September 2017. This geotechnical report should be read in conjunction with the aforementioned report.

This report presents the results of our investigation and provides geotechnical recommendations and considerations for design and construction. Limitations associated with this report and its contents are outlined in the Statement of General Conditions provided in **Appendix A**.

MILL CREEK RAVINE TRAIL REHABILITATION

Site Description
January 12, 2018

2.0 SITE DESCRIPTION

Mill Creek is a tributary to the North Saskatchewan River (NSR) in Edmonton. The trail system within the Mill Creek Ravine has been subject to multiple erosion and slope stability problems in recent history. The creek meanders generally from southeast to northwest, and receives runoff from nearby residential, commercial and industrial lands within the drainage basin. The ravine is currently used for recreational purposes, with a comprehensive network of gravel and paved multi-use trails, as well as picnic and scenic viewpoints. The ravine slopes are generally well vegetated with the exception of distinct steeply sloped areas along the creek escarpment.

In an effort to provide and maintain a safe trail network through the Mill Creek Ravine, the City of Edmonton has identified three sites for remediation due to bank erosion that is impacting the trail. The sites were identified in the Request for Proposal as:

- Site 1: Mill Creek Ravine Trail Realignment South of Bridge 277;
- Site 2: Mill Creek Ravine Park: Disaster Recovery Project #32; and,
- Site 3: Mill Creek Ravine Trail Realignment near Shamrock Curling Club.

These sites are located between 76 Avenue NW and 92 Avenue NW. The location of each site is shown in **Figure 1** in **Appendix B**. **Figures 2** through **4** show detailed site plans for each of the three sites. Photos from a site reconnaissance are included in **Appendix C**. All photos were taken during the on-site feasibility meeting on May 16, 2017, unless otherwise noted.

The primary goal of the City is to provide long-term cost-effective remediation solutions that will have minimal environmental impact. The City has indicated a preference for realignment of the trail away from the eroded areas; however, multiple options have been considered at this conceptual level design.

2.1 SITE 1: MILL CREEK RAVINE TRAIL REALIGNMENT SOUTH OF BRIDGE 277

Site 1 (**Figure 2** in **Appendix B**) is approximately 20 metres (m) south of Bridge 277 on the east side of Mill Creek. The terrain at the site is generally flat to gently rolling, and there appears to be a slightly raised terrace at the base of the valley wall. The main trail at this site is located at the base of the ravine, along the top of the creek bank. At the distressed location, the trail follows the outside bend of a meander, which is currently being undercut by the creek (**Photo 1** and **Photo 2, Appendix C**), resulting in significant erosion. The creek encounters the bank at a nearly 90° angle. The height of the bank varies from approximately 1.5 m 3.5 m.

The main trail is currently closed at this location; however, the public is still able to access the eroded section. A secondary single track trail traverses the treed area to the east and upslope of the main trail (**Photo 3, Appendix C**). Much of this secondary trail appears to be situated on colluvial material from relic landslides along the toe of the Mill Creek Ravine slope.

MILL CREEK RAVINE TRAIL REHABILITATION

Site Description
January 12, 2018

2.2 SITE 2: MILL CREEK RAVINE PARK: DISASTER RECOVERY PROJECT #32

Site 2 (**Figure 3** in **Appendix B**) is located on the east valley wall of the Mill Creek Ravine, north of 82 Avenue and south of the Mill Creek Outdoor Pool. This site is situated within the old 82 Avenue Right of Way (ROW). This ROW was developed in 1911 and spanned the creek with a 150 m steel viaduct (Alberta Transportation Bridge File 6617). The ROW was realigned in the early 1960's after construction was completed on the current 8 span, 223 m long concrete girder bridge. The foundation for the east abutment of the first bridge was located near Site 2, and the concrete footings can be seen in the creek bed, and on the northeast slope below the trail.

The affected trail at this site is about 2 m wide, and is located on a mid-level bench within the east bank of the ravine between two relic landslides. **Figure 5** in **Appendix B** shows a site plan including elevation contours based on Light Detection and Ranging (LiDAR) data. Mill Creek Ravine is approximately 10 m to 12 m below the trail at an elevation of about 640 m, and the crest of the ravine is approximately 10 m above the trail, for an overall slope height in the order of 20 m.

The knob of land between the landslides and above the trail is sloped at approximately 5 horizontal to 1 vertical (5H:1V) from trail level to the crest of Mill Creek Ravine. A timber retaining structure is currently located at the toe of this upper slope at trail level (**Photo 4, Appendix C**).

Below the trail, the bank of Mill Creek Ravine, is nearly vertical over a distance of approximately 30 m, and sits along the outside bend of a meander (**Photo 5, Appendix C**). The bank is currently being eroded by the creek, which impacts the bank at a nearly 90° angle. A wooden fence is currently installed at the crest of the near-vertical bank for public safety. A visual inspection of the near-vertical bank indicated that the bedrock contact is about 6 m to 7 m above creek level. Toe erosion is likely to continue, which will have an impact on the long term usability of the trail at its existing location.

A secondary single-track trail branches off to the west of the main trail and serves as an unmaintained shortcut to the Mill Creek Pool which is located at the base of the valley slope. This trail appears to be well used by the public. Another single-track trail climbs from the main trail and traverses the knob between the two landslides.

A condominium building is located at the top of the valley slope, approximately 8 m to 10 m east of the crest of the ravine and 100 m to the east of Site 2. A setback assessment conducted in a 2005 geotechnical report recommended a development setback requirement of a minimum of 7.5 m from the top of bank of slopes (Thurber 2005).

MILL CREEK RAVINE TRAIL REHABILITATION

Site Description
January 12, 2018

2.3 SITE 3: MILL CREEK RAVINE TRAIL REALIGNMENT NEAR SHAMROCK CURLING CLUB

Site 3 is approximately 150 m south west of the 93 Street NW and 78 Avenue NW intersection, and about 30 m north of Bridge 207. The main trail at this site is 3 m wide, and is located at the top of the bank along the outside bend of a meander, which is currently being undercut by the creek (**Photo 6, Appendix C**). Creek erosion has resulted in a reduced trail width of approximately 2 m over a 6 m long section. Similar to the other two sites, the creek is impacting the bank at an approximately 90° angle. The trail is currently still open to the public.

The height of the bank is approximately 1.5 m to 2.0 m above the creek. The surrounding area is generally flat to gently rolling. The trail appears to be located adjacent to the toe of the ravine slope. A secondary single track trail is located within the treed area to the east of the main trail (**Photo 7, Appendix C**).

MILL CREEK RAVINE TRAIL REHABILITATION

Assessment
January 12, 2018

3.0 ASSESSMENT

The geotechnical assessment included a desktop review of publicly available information, a terrain analysis at Site 2 due to the complex geometry and geohazards at the site, and a field investigation at each site with laboratory testing on select soil samples to characterize subsurface soil, bedrock, and groundwater conditions.

3.1 DESKTOP REVIEW

Publicly available bedrock and surficial geology maps, geotechnical reports and papers, LiDAR data, and historical air photos were reviewed during the desktop study. Select geotechnical reports for nearby projects were provided by the City.

The Mill Creek Ravine trail system lies within the Lake Edmonton Plain District of the Eastern Alberta Plains Physiographic region (Pettapiece 1986). The surficial soils are typically comprised of glaciolacustrine deposits consisting of bedded sands, silts and clays from Glacial Lake Edmonton. Underlying the glaciolacustrine soil is a glacial till deposit containing unsorted and unstratified sediments consisting of clays, silts, sands, and gravels, with cobbles and boulders. The Edmonton Formation Bedrock underlies the till and is composed of interbedded bentonitic shales and sandstones with frequent coal seams that tend to dip southwestward (Kathol and McPherson 1975).

Throughout all three sites, the meandering Mill Creek undercuts the outer bank resulting in erosion and stability issues. This erosional process is causing the banks to retrogress outwards and encroach on the park trails resulting in the need for rehabilitation of certain segments of the trail system. A review of historical aerial photography and bare earth LiDAR imagery revealed several large-scale relic landslide scarps along the valley walls and ravine escarpment. These relic slides can have an impact on the remediation design at each site, which will be detailed in the following sections. Due to the perceived higher geohazard risk at Site 2, a more detailed terrain assessment was conducted, the findings of which are presented in **Section 3.2**.

A review of Alberta Energy Regulator Coal Mine Map Viewer indicated that a relatively large abandoned room and pillar type mine (Mine No. 0177, Twin City Coal Mine) was located approximately 450 m north of Site 1. This coal mine is not expected to pose any risk to the rehabilitation of this site. No other coal mines were identified at or near the other sites.

In 2016, Associated Engineering Ltd. (AE) carried out an erosion study in the Mill Creek Ravine (AE 2016), which included the sites under the present study along the trail system. Findings of the report indicated that Mill Creek is actively down cutting, leading to slumping and increased erosion at several locations along the creek. Surface water runoff down the valley slopes was also identified as a contributing factor to instability. Proposed erosion mitigation techniques included hard armouring, bio-engineering/soft armouring, or a combination of both. The report noted that erosion control measures would not provide a permanent solution, and ongoing

MILL CREEK RAVINE TRAIL REHABILITATION

Assessment
January 12, 2018

maintenance would be required. The report assessed the subject sites in terms of erosion potential and provided high level remediation options for each. These are summarized below:

- Site 1: Combination of a gabion rock wall, with earth-filled vegetated wall or bioengineered above gabions, approximate cost estimate of \$3.4M.
- Site 2: An engineered design for slope stabilization was recommended comprised of armouring the toe of the ravine at the creek level with gabion blocks, and vegetate above the gabions, approximate cost of \$2.6M.
- Site 3: Leave minor amounts of debris in stream for naturalization and install bioengineered wall, live staking or wattles, approximate cost estimate of \$0.6M.

In 1981, the City advanced 15 boreholes along the west bank of Mill Creek as part of an investigation for tunnel construction. These boreholes were drilled between Site 1 and Site 2, and confirmed the expected stratigraphy for the area of clay overlying clay till overlying clayshale and sandstone bedrock. The top of bedrock was encountered at elevations varying from 638.5 m to 642.0 m. Several coal pockets were identified in the bedrock between elevations of 627 m and 635 m.

In 2005, Thurber Engineering Ltd. (Thurber) conducted a top of bank set back assessment for the condominium located at the crest of the Ravine at Site 2 (Thurber 2005). The report noted the steep eroded bank and that it would have no impact on the development, but it would affect the trail at some point in the future. It was determined through site observations and air photo review that the valley appeared to be stable at that time and had not regressed significantly in the preceding 50 years. Thurber did mention that some regression may occur over time due to weathering, changes in groundwater conditions, and surface water runoff. Findings from three boreholes at the site showed high plastic glaciolacustrine clay overlying clay till overlying clayshale bedrock with siltstone and sandstone laminations and lenses. The top of bedrock was encountered at elevations between 646.5 m and 651.5 m. Seepage was noted in one of the boreholes from a thin layer of silt at elevation 656.9 m and a groundwater elevation of 651.5 m one week after drilling.

In 1990, Hardy BBT Ltd. (Hardy) conducted a geotechnical investigation for a landslide within the Mill Creek Ravine to the southwest of Site 3. Boreholes drilled during the investigation again confirmed the expected soil conditions within the valley of clay overlying clay till overlying bedrock.

3.2 TERRAIN ANALYSIS AT SITE 2

The terrain analysis for Site 2 was conducted by reviewing publicly available bedrock and surficial geology maps, historical air photos of the site, and LiDAR data. The general geographic setting and typical stratigraphy at this site is as described above.

MILL CREEK RAVINE TRAIL REHABILITATION

Assessment
January 12, 2018

3.2.1 Air Photo Review

An historical air photo review of the site was completed to assess changes in the eroded bank. Air photos and aerial imagery dating from 1962 to 2016, as well as Google Earth imagery from 2016, were obtained and reviewed.

Considerable changes to the alignment of Mill Creek were observed on the air photos. This is a result of both natural stream migration and man-made alterations aimed at straightening the channel and controlling erosion. Channel migration is particularly noticeable at the meander bend at Site 2, where Mill Creek has shifted approximately 16 m to the north between 1962 and 2016 (~30 cm/year).

Retrogression of the steep bank can also be observed on the historic air photos. At the meander bend, Mill Creek is eroding the toe of the steep bank, and undercutting the slope, resulting in slumping of the exposed materials on the slope. Over time, this has resulted in steepening of the bank and retrogression of the bank closer to the trail at Site 2. Migration of the channel and retrogression of the bank can be observed on the air photos (**Air Photos 1 through 6 in Appendix D**). The approximate 2016 Mill Creek channel alignment is drawn on the air photos as a blue dashed line for reference, and the approximate top of the eroded bank is shown in dashed red.

3.2.2 LiDAR Review

LiDAR data at 30 cm resolution was processed to produce a hill shade image and slope map. The slope map was overlain onto the hill shade image to create the map in **Figure 5 in Appendix B**. The LiDAR shows a succession of terraces on the west (left) bank of the meander bend, marking the migration of Mill Creek northwards. The steep, eroding east (right) bank is prominent on the LiDAR, and the slope map indicates that the bank exceeds 100% steepness (> 1H:1V).

3.2.3 Summary

Lateral erosion is occurring along the east (right) bank at a meander bend of Mill Creek. Bank erosion of the toe slope has led to over steepening and slumping of the exposed normally consolidated sediments. Over the period from 1962 to 2016, Mill Creek has migrated northwards, leading to progressive steepening of the east (right) bank below Site 2 and retrogression of the bank slope towards this section of the Mill Creek Ravine Park trail.

This migration and subsequent bank erosion will likely continue if left unmitigated. The creek will continue to erode the toe slope, cutting into the slope and eventually the steep bank will retrogress and the existing trail will likely slide into the creek. Surficial geology mapping, reviewed as part of the background information on the site, indicates that glaciolacustrine material overlies till on the slope at Site 2 (Kathol and McPherson 1975), which was verified during the current field investigation. Glaciolacustrine materials are typically fine-grained and are prone to slope movements when the with erosion and steep side slopes.

MILL CREEK RAVINE TRAIL REHABILITATION

Assessment
January 12, 2018

3.3 SITE INVESTIGATION

Prior to the field investigation program, Stantec coordinated the location of underground utilities using Alberta One Call and a third-party locator. The purpose was to identify the locations of underground utilities near the proposed borehole and hand auger locations. Stantec also undertook the City's Project Request process for projects that fall under the North Saskatchewan River Valley Area Redevelopment Plan (Bylaw 7188).

The field drilling program was carried out on August 1, 2017. A total of four boreholes (BH17-01, BH17-02, BH17-03, and BH17-04) were drilled using a 150 mm solid stem auger on a track mounted drill rig. These boreholes were drilled at Sites 2 and 3.

At the borehole locations, disturbed grab samples were collected from the augers at approximately 1.5 m intervals and Standard Penetration Tests (SPT) were carried out at every 1.5 m interval by utilizing a 50 mm diameter split-spoon sampler. For BH 17-03 and BH17-04, SPTs were carried out every 0.75 m for the first 3.0 m below ground surface (bgs) and then at 1.5 m intervals for the remainder of the borehole. Relatively undisturbed Shelby tube samples were obtained at select depths.

Three hand auger holes (HA17-01, HA17-02, and HA17-03) were also advanced. Disturbed grab samples were collected from the hand auger at approximately 0.3 m intervals. The hand auger holes were advanced at Site 1.

All test holes were advanced near the edge of existing trails. The location of each borehole and hand auger hole with the corresponding drill depth is summarized below:

- Site 1: HA17-01, HA17-02, and HA17-03 hand-augered to depths ranging from 1.2 m to 2.5 m bgs;
- Site 2: BH17-01 and BH17-02 were drilled to 9.6 m bgs each; and,
- Site 3: BH17-03 and BH17-04 to 3.5 m bgs each.

A 25 mm diameter PVC standpipe piezometer was installed in BH17-02 (Site 2) with the slotted section extending from 5.2 m to 8.2 m bgs. All other test holes were backfilled with cuttings and sealed with bentonite near surface to minimize surface water infiltration.

Test hole locations were measured using a hand-held GPS unit. Elevations were estimated based on available LiDAR information. Plans showing borehole locations is shown in **Figure 2, 3, and 4** in **Appendix B**.

3.4 LABORATORY TESTING

All soil samples recovered from the test holes were placed in water-proof sampling bags and returned to our laboratory for further geotechnical classification and testing. Laboratory tests included natural water content, Atterberg limits, and grain size distribution. Detailed results of the

MILL CREEK RAVINE TRAIL REHABILITATION

Assessment
January 12, 2018

laboratory testing can be found in the attached borehole records in **Appendix E** and laboratory testing reports in **Appendix F**.

The soil and groundwater conditions encountered in the boreholes are described in detail on the borehole records, included in **Appendix E**, and summarized in **Section 3.5**. Also included in **Appendix E** are the symbols and terms used on borehole and hand auger hole records.

3.5 SUBSURFACE CONDITIONS

3.5.1 Site 1

The approximate ground surface elevations of HA17-01, HA17-02, and HA17-03 were 635.3 m, 636.0 m, and 631.3 m, respectively. Between 150 mm and 200 mm of topsoil was encountered from ground surface.

A firm to stiff medium plastic clay was encountered beneath the topsoil at each hand auger location extending to a depth of approximately 0.8 m to 1.3 m bgs. This soil was brown, moist, and contained some sand, some silt and organics. Water contents varied from 14% to 20%, with an average of 18%. One Atterberg limit test in this soil showed a Liquid Limit of 43% and a Plasticity Index of 23%.

A stiff, light brown sandy clay till with some silt, was encountered beneath the medium plastic clay at each hand auger test hole. The clay till contained occasional silt laminations, occasional, coal fragments. Water contents varied from 14% to 20%, with an average of 16%. At HA17-02 and HA17-03, the hand auger refused in what was believed to be sand or gravel pocket or layer within the till.

At HA17-01, a well graded, moist, sand was encountered beneath the till. This material had a water content of 16%.

No groundwater, seepage, or sloughing was encountered during drilling activities.

3.5.2 Site 2

The ground surface elevations of BH17-01 and BH17-02 were 650.3 m and 652.3 m, respectively. The top surface consisted of 50 mm to 100 mm of gravel fill underlain by dark brown topsoil to a depth of 0.8 m bgs at BH17-01. No topsoil was encountered at BH17-02.

Below the topsoil at BH17-01 and below the gravel fill at BH17-02, a layer of soft to stiff, brown, silty, low plastic clay was observed to depths of 2.3 m to 2.9 m bgs. This soil had water contents ranging from 13% to 18%, with an average of 15%. One Atterberg limit test conducted on this material showed a Liquid Limit of 41% and a Plasticity Index of 23%.

Colluvial material comprising a mixture of reworked clayshale and clay fill was encountered below the low plastic clay at BH17-01 to a depth of 2.8 m bgs. Two water contents of 15% and

MILL CREEK RAVINE TRAIL REHABILITATION

Assessment
January 12, 2018

17% were determined. While not encountered in this investigation, cobbles and boulders are commonly found in clay fill deposits.

Extremely weak, high plastic, dark grey clayshale was encountered below the clay and colluvial soil. This material contained coal fragments from 6.5 m to 8.1 m bgs. A 10 mm thick bentonite seam existed at a depth of 2.9 m bgs in BH 17-01 within the clayshale. Water contents varied from 17% to 24%, with an average of 19%. The clayshale had a Liquid Limit of 57% and a Plasticity Index of 30%.

The clayshale was underlain by extremely weak, blueish grey bentonitic sandstone, which extended to the termination depth of each borehole. The water content of the sandstone varied from 18% to 24%, with an average of 20%.

No groundwater, seepage, or sloughing was encountered during drilling activities. Groundwater levels were measured in the standpipe piezometer installed at BH17-02 on August 16, 2017, approximately two weeks after drilling. The standpipe was found to be dry at that time. Previous investigations indicated that a water level within the surficial soils was located at a depth of between 10 m and 11 m bgs as measured from the crest of the ravine. It is common that groundwater levels will vary throughout the year based on climatic conditions.

3.5.3 Site 3

The ground surface elevations of BH17-03 and BH17-04 were 650.3 m and 649.2 m, respectively. The top surface consisted of 50 mm of gravel fill.

A layer of light brown clay with some silt was encountered below the gravel trail fill at BH17-03 to a depth of 0.9 m bgs, but was not observed at BH17-04. The clay was medium plastic, and had a soft to firm consistency. One water content of 15% was determined.

A layer of well-graded gravel was encountered below the clay at BH17-03 and below the gravel fill at BH17-04 up to depths of 0.5 m to 1.5 m bgs. The water content of this material was 5%. A grain size analysis showed that this material contained 70% gravel, 4% sand, and 25% fines (silt and clay). The gravel at BH17-04 had a high estimated clay content, and as such, the water content was found to be 15%.

Extremely weak, weathered, high plastic, brown to grey, oxide stained clayshale was encountered below the well graded gravel, and extended to the termination depth of each borehole. Water contents of this material ranged from 18% to 25%, with an average of 21%. The Liquid Limit and Plasticity Index of this material was determined to be 55% and 36%, respectively.

No groundwater, seepage, or sloughing was encountered during drilling activities.

MILL CREEK RAVINE TRAIL REHABILITATION

Discussion and Recommendations
January 12, 2018

4.0 DISCUSSION AND RECOMMENDATIONS

Several conceptual rehabilitation options have been provided for each site. Generally, each of the proposed conceptual options, as discussed below, is considered feasible from a geotechnical perspective.

Some of the main design factors for the rehabilitation of these sites include:

- Presenting a cost effective solution that will have some longevity;
- Minimizing impacts to the environment;
- Meeting trail grade requirements for accessibility, preferably without the use of stairs;
- Providing adequate sight lines for trail user safety; and,
- Addressing stability of slopes.

Detailed descriptions of each option are presented in Stantec's Draft Site Assessment and Design Analysis Report, dated September 2017. The following sections provide a summary of the high level conceptual rehabilitation options, and geotechnical considerations and recommendations associated with each of the options. High level cost estimates are presented in the Draft Site Assessment and Design Analysis Report.

4.1 WORKING IN GEOHAZARD AREAS

As noted above, much of the Mill Creek Ravine slopes have been subject to instability in the past. In this type of terrain, the soil along the previous failure plane is likely to be at or near residual strength. Disturbance to these areas, such as excavating at the toe of a slope, loading the crest, or urban development, has the potential to reactivate relic slides. The conceptual rehabilitation options for each of the sites should consider minimizing disturbance of this type as much as practical.

Disturbance can be minimized by:

- Maintaining a safe offset limit from the tops of slopes and ravine escarpment;
- Minimizing cuts and fills on the slope;
- Keeping soil stockpiles, construction equipment and other materials away from the crest of slopes or excavations;
- Minimizing the time that excavations are left open;
- Having a plan to protect open excavations during precipitation events;
- Grading the site to promote positive surface water drainage away from slopes;
- Minimizing tree and other vegetation removal on slopes; and,
- Armouring or using bioengineering to stabilize the ravine escarpment.

4.2 GENERAL TRAIL CONSTRUCTION RECOMMENDATIONS

Construction of new main trails should follow the standard guidelines presented in Volume 5 of the City of Edmonton's Design and Construction Guidelines (COE 2017), and drawing number LA303 in particular (attached for reference **Appendix B**).



MILL CREEK RAVINE TRAIL REHABILITATION

Discussion and Recommendations
January 12, 2018

The following minimum recommendations are provided for construction of new trails at each of the sites, as detailed in the COE Design and Construction Guidelines:

- Remove all trees within the design trail footprint;
- Topsoil and organic subsoil should be removed from the entire footprint of the new trail. Up to 200 mm thickness of this material was encountered during the investigation but can be expected to vary;
- Upon removal of organic soil, the exposed subgrade surface should be left in an undisturbed state. Any tree stumps, roots, cobbles or boulders, or other debris should be removed if protruding from the subgrade surface;
- Any fill required to raise the subgrade surface to design grades should be comprised of low to medium plastic clay soil or 20 mm crushed granular material compacted to a minimum of 97% Standard Proctor Maximum Dry Density (SPMDD);
- Woven geotextile (Nilex 4551, Layfield LP6, or equivalent as per drawing number LA303) should be placed on the prepared subgrade surface. Manufacturer's instructions should be followed for overlapping panels and pinning the fabric to the subgrade;
- A minimum thickness of 100 mm of 20 mm minus crushed gravel should be placed on the geotextile and compacted to at least 97% SPMDD;
- The top course should comprise a 50 mm thick layer of 6 mm minus granular material compacted to at least 97% SPMDD; and,
- The subgrade surface and granular trail surface should be shaped to provide positive drainage away from the trail.

4.3 SITE 1

Two conceptual remediation options are proposed for Site 1. These are, in brief:

- Option 1: Upgrading the existing secondary single track trail to a main trail
- Option 2: Offsetting the existing main trail away from the bank of the creek

For both options, minimal earthwork activity is anticipated. However, it is recommended that, for Option 1, design grades be optimized to minimize excavating at the toe of the ravine slope. As noted in the desktop review, soil conditions along the Mill Creek Ravine are generally fine grained and somewhat sensitive to disturbance. Much of the trail in the ravine is located within ancient landslide terrain which has the potential to be reactivated upon unloading soil from or near the toe of the slope.

While Option 1 results in a new main trail at an adequate distance from the creek bank, the sight lines are not ideal when approaching from the north. Further, the City has noted that it is likely that the public will establish a new single track trail through the treed area. Option 2 would allow the existing single track to be left in place while shifting the main trail away from the creek.

MILL CREEK RAVINE TRAIL REHABILITATION

Discussion and Recommendations
January 12, 2018

Option 2 would include constructing a new main trail between the existing eroded trail and the secondary single track trail. The route would be optimized to minimize earthworks while maintaining satisfactory sight lines. This option has the additional benefit of reducing excavation at the toe of the ravine.

Trail realignment will include closing the existing main trail and planting trees and other vegetation as compensation for any trees cleared during realignment. Based on the findings from the hand auger holes advanced at Site 1, trail realignment is considered feasible from a geotechnical perspective. The in situ soil is expected to provide a suitable subgrade for construction of a new trail.

Construction of the new trail should follow the recommendations provided in **Section 4.2**.

Option 2 (offsetting the existing trail) is the preferred remediation option for this site.

4.4 SITE 2

Three conceptual options are proposed for Site 2, as follows:

- Option 1: Short radius trail realignment with an approximately 1.5 m high retaining wall
- Option 2: Long radius trail realignment with an approximately 2.0 m high retaining wall
- Option 3: Upgrading the existing single track trail over the knob

The City has indicated that the proposed rehabilitation options should only consider realignment of the trail while allowing the creek to undergo natural erosion processes that may result in further retrogression of the slope. Therefore, all three options do not consider stabilizing the steep bank or armouring the toe of the bank to protect from future erosion.

Both Options 1 and 2 consist of excavating into the 5H:1V slope above the trail and constructing a retaining wall along the excavated face. The greater the radius selected for the new trail alignment, the further offset from the crest of the steep slope the trail would be. A further offset would result in additional time that can be tolerated before additional remediation measures are necessary that would result from future retrogression of the steep slope. The City has expressed interest in Option 2, which provides a balance between stability of the upper slope while allowing a reasonable amount of room for the steep bank to erode without impacting the new trail for the near future.

Option 3 would require minor grading work in the slope above the trail; however, optimization would be required to maintain satisfactory trail grades. Stairs may be required depending on route selection, which would limit the accessibility to the public on the trail system. For this reason, Option 3 is the least preferable, and the following discussion only considers Option 1 and 2.

Option 2 (longer radius trail realignment) is the preferred remediation method for this site. Further details are provided in the following sections.

MILL CREEK RAVINE TRAIL REHABILITATION

Discussion and Recommendations
January 12, 2018

4.4.1 Slope Stability Assessment

To support the design of a retaining wall for Options 1 and 2, slope stability analyses were carried out on the existing slope geometry based on LiDAR data. The slope stability assessment is conceptual in nature, and several assumptions were made to develop the analytical model. The analysis should be reviewed at the detailed design stage to verify that these assumptions remain valid.

Only the upper 5H:1V slope above the trail was analyzed for the conceptual design of the retaining structure options. Global stability of the overall valley wall was not carried out as the City preferred an option that considered trail realignment to negate stabilizing or armouring the lower steep bank. However, a brief analysis of the stability of the steep bank below the trail was conducted, although the preferred mitigation does not include any form of stabilization of this slope.

The slope stability analysis computer software program GeoStudio 2016, by GEO-SLOPE International Ltd, was used for the analysis, which is based on the Limit Equilibrium Method. The analyses were based on the "Morgenstern-Price" method, which satisfies both force and moment equilibrium in the calculations for the factor of safety (FOS).

4.4.2 Analytical Model

Two cross-sections (Section A shown on **Figure 6**, and Section B shown on **Figure 7** in **Appendix B**) were developed at the site based on existing LiDAR data. The location and orientation of these sections are shown on **Figure 3** in **Appendix B**. Section A was determined to be the critical section for the design of a retaining structure, while Section B was used as the critical section through the steep bank below the trail.

The slope stability model was developed by evaluating the results of the current geotechnical investigation as well as the previous investigation carried out in 2005 by Thurber (see Section 3.1).

Both the current investigation and the 2005 investigation showed variability in the surficial soil conditions, comprising medium to high plastic clay with silt layers and pockets, overlying clay till or colluvial material consisting of reworked clay till and clayshale. Results of the current 2017 investigation suggested that the near surface clayshale bedrock is highly weathered, which likely has an impact on the shear strength parameters. The bedrock contact was approximately 2.9 m below ground surface at the affected trail location, and approximately 7.5 m above creek level. Additionally, a thin continuous bentonite seam was included in the model approximately 1 m below the bedrock surface to reflect findings from the 2017 investigation.

Soil strength parameters used in the analysis, shown below in **Table 1**, were selected based on published data (Thomson & Yacyshyn 1976; Ruban, Patrick & Skirrow 2004; Peters & Lamb 1979), correlations with laboratory and in situ testing, and Stantec's experience with similar soil conditions in the Edmonton area. Conservative strength parameters were selected to account for a high degree of variability in the surficial clay, glacial till and bedrock.

MILL CREEK RAVINE TRAIL REHABILITATION

Discussion and Recommendations
January 12, 2018

Table 1 Soil Shear Strength Parameters used in Stability Analysis

Material	Unit Weight, γ (kN/m ³)	Effective Friction Angle, ϕ' (degrees)	Effective Cohesion, c' (kPa)	Undrained Shear Strength, C_u (kPa)
Clay Fill	18	20	0	N/A
Clay	19	20	0	25
Clay Till	20	28	0	40
Clayshale Bedrock (Upper)	20	25	0	50
Clayshale Bedrock (Lower)	20	25	50	100
Sandstone	21	35	25	N/A
Bentonite Seam	18	14 ⁽¹⁾	0	N/A

Notes:
(1) The bentonite seam was modelled using a friction angle of 14 degrees and checked for a residual friction angle of 8 degrees

4.4.3 Slope Stability Analysis Methodology

A back analysis is typically done as a verification of selected parameters at a known Factor of Safety (FOS), such as at incipient failure (ie, a FOS of unity). Since the site is located adjacent to relic landslides and there hasn't been a recent failure at this site, the FOS is unknown, and a back analysis cannot be completed. In this case, a FOS was determined for the existing slope geometry using the strength parameters provided above and compared to the geometry for the proposed conceptual design options and reported as a percent change.

4.4.3.1 Upper Slope

Two cases were evaluated for relative stability of the upper 5H:1V slope for the conceptual design options:

1. Stability of the upper slope above the trail
2. Stability of the excavated slope during construction

For stability of the upper slope, a series of slip surface scenarios were analyzed, including a conventional circular surface and a block specified search with the failure plane passing through the weak bentonite seam. The upper slope was modelled using drained soil parameters to represent long term conditions, while the cut slope was modelled using undrained parameters

MILL CREEK RAVINE TRAIL REHABILITATION

Discussion and Recommendations

January 12, 2018

to represent short term conditions during construction. The groundwater table was assumed based on the results of piezometer measurements from the 2017 and 2005 investigations.

4.4.3.2 Steep Bank

The steep bank was analyzed for an approximate existing FOS using the parameters provided in **Table 1** above. The stability of this slope is believed to be primarily influenced by erosion as the creek impacts the bank at a near vertical angle. Conventional stability analysis considers circular or block type failures. Lower toe erosion will usually decrease the resisting forces available within a particular slip surface, and therefore lower the FOS as erosion progresses.

A typical failure process begins with erosion near the toe and surficial sloughing of the exposed bedrock and soil, resulting in steepening of the bank. After reaching a critical angle, further surficial sloughing would occur until a FOS greater than unity is reached. The process would then repeat itself. Conditions are typically worsened during flooding when water levels and velocities are generally higher.

4.4.4 Slope Stability Analysis Results

The results of the slope stability analysis are presented in **Appendix G**, and summarized below in **Table 2**.

Table 2 Results of Slope Stability Analysis

Section	Geometry	Factor of Safety	Percent Change in FOS	Figure
A: Upper Slope, Circular Failure (Drained conditions)	Existing	1.53	N/A	G.1
	Option 1: Short Radius	1.46	-5%	G.2
	Option 2: Long Radius	1.43	-7%	G.3
A: Upper Slope, Block Failure (Drained conditions)	Existing	1.57	N/A	G.4
	Option 1: Short Radius	1.55	-1%	G.5
	Option 2: Long Radius	1.54	-2%	G.6
A: Cut Slope (Undrained conditions)	Option 1: Short Radius (vertical cut)	2.85	-	G.7
	Option 1: Short Radius (1H:1V cut)	3.98	-	G.8
	Option 2: Long Radius (vertical cut)	2.45	-	G.9
	Option 2: Long Radius (1H:1V cut)	3.31	-	G.10
B: Steep Bank	Existing	1.15	-	G.11

MILL CREEK RAVINE TRAIL REHABILITATION

Discussion and Recommendations
January 12, 2018

Based on the results of the stability analysis presented above, both Option 1 and 2 lead to minimal decreases in the FOS for long term conditions. Further, the results indicated adequate factors of safety for short term construction conditions. The existing geometry of the steep bank shows a relatively stable condition for a circular failure surface, however, this will be heavily influenced by creek levels, especially during flood conditions.

The FOS values presented in the above table are considered conservative due to the parameters used in the analysis. Additionally, no lateral support from the retaining structure was considered. Generally, the FOS can be expected to decrease during wet weather conditions leading to flooding of the creek, and to increase during dry periods.

The impact of erosion on the steep bank is difficult to assess in conventional stability analysis. Given the somewhat slow migration of the top of bank and the lack of visual signs of movement (i.e., tension cracks, toe bulging, etc.) within the slope, the bank is believed to be marginally stable, however, the results show a FOS of just above unity.

As noted above, the conceptual remediation options do not address the stability of the steep bank below the trail. It is highlighted here that this will be an ongoing issue, and trail realignment will only buy time. An engineered solution or more drastic realignment will eventually be necessary to avoid losing the trail completely.

4.4.5 Other Geotechnical Considerations

The proposed conceptual designs currently call for maximum retaining wall heights of approximately 1.5 m for Option 1, and approximately 2 m for Option 2. A common type of retaining structure used in many parts of Edmonton's river valley trail system is a wooden pile wall with timber lagging. This type of wall is currently in place at the toe of the upper slope at Site 2. This type of wall is considered feasible from a geotechnical perspective for both conceptual options.

The expected construction sequence will involve removal of the existing wooden retaining structure, grading the new trail alignment, installing the new retaining structure, and revegetation of the existing trail. General trail construction recommendations provided above in **Section 4.2** are valid for this site as well.

The following provides a summary of geotechnical recommendations associated with the work.

4.4.5.1 Excavation

Prior to the start of construction activities, the contractor should install erosion protection along the edge of the trail. This can comprise diversion swales or berms, silt fence, sediment ponds, wattles, or similar. No sediment should be allowed to enter Mill Creek as a result of construction activities.

Although the results of the analysis showed suitable factors of safety for vertical excavations, it is recommended that the cut face be no steeper than 1H:1V benched at 0.5 m horizontal by

MILL CREEK RAVINE TRAIL REHABILITATION

Discussion and Recommendations
January 12, 2018

0.5 m vertical increments. This is to account for the high degree of variability observed in the surficial soils and near surface bedrock. Further, the contractor should schedule construction activities to minimize the time that the cut slope is left open.

The contractor should be prepared to intercept and handle groundwater seepage, sloughing soils (i.e., from wet silt or sand pockets), and surface water runoff during precipitation or snowmelt. It is expected that the rate of seepage will be such that site grading to provide positive drainage away from the excavation will be sufficient. The site should also be graded to minimize the amount of water flowing over the steep bank. If excessive seepage or sloughing soils are encountered, the slope may need to be cut back to a shallower angle.

During excavation, construction equipment, materials, and stockpiles of excess soil should not be placed within 2 m of the crest of the steep bank, or anywhere on the slope above the trail. Excess soil should be removed from site as soon as possible to minimize loading on the bank.

There are two options for the cut slope on the downslope side of the excavation:

- Remove all native material and revegetate; or,
- Leave the material in place, and cut to a slope of 3H:1V or flatter.

Given the limitations associated with the equipment that will be able to access the site, the latter option is preferred. No retaining structure is necessary for this slope.

The excavation work should be monitored by qualified geotechnical personnel for signs of movement in the slope above the trail. If tension cracks or other signs of instability are observed in the slope, construction should be halted immediately to assess the extent and impact of the movement. The most recent version of the Alberta Occupational Health and Safety (OH&S) code must be followed.

4.4.5.2 Backfill

The native site soils can be used to backfill the excavated zone behind the retaining structure provided the moisture content is suitable for compaction. This material should be placed in horizontal lifts not exceeding 200 mm (loose measure), and compacted to a minimum of 98% of Standard Proctor Maximum Dry Density (SPMDD) at $\pm 3\%$ of Optimum Water Content (OWC). The native soil was found to vary from slightly below to up to 7% over the plastic limit, and may indicate that moisture conditioning will be required to achieve the necessary compaction. Alternatively, a crushed granular material, such as City of Edmonton (COE) Designation 3, Class 25 or similar approved material. The backfill zone should match the existing grade of the slope.

A minimum 300 mm wide granular drainage zone should be placed immediately behind the retaining structure to facilitate drainage and reduce groundwater pressures. This material should be comprised of a free draining granular soil such as COE Designation 6, Class 25 or similar, and should be nominally compacted. The drainage zone should be wrapped in a non-woven geotextile to limit migration of fines from the backfill zone.

MILL CREEK RAVINE TRAIL REHABILITATION

Discussion and Recommendations
January 12, 2018

4.4.5.3 Retaining Structure

The design of retaining structures is typically carried out by third party contractors that perform their own internal stability analyses. At the conceptual stage, it is assumed that a timber structure, such as the wall currently in place, will be constructed.

It is recommended that the vertical members be installed in pre-drilled shafts into the bedrock and cemented in place. These members should extend into the bedrock by a minimum of 4 m, which would be an embedment depth ranging from about 6 m and 7 m. The bedrock surface elevation varies at this site, and qualified geotechnical personnel should inspect the shaft excavations to verify assumptions made during design.

The parameters provided in **Table 3** below should be used in the design of the retaining structure at this site. The active and passive earth pressure coefficients are provided for the condition of a sloping ground surface behind the retaining structure.

Table 3 Soil Parameters for Retaining Wall Design

Soil Type	Unit Weight, γ (kN/m ³)	Effective Friction Angle, ϕ' (degrees)	Lateral Earth Pressure Coefficients		
			At Rest, K_0	Active, K_a	Passive, K_p
Clay	19	20	0.66	0.55	1.77
Clay Till	20	28	0.53	0.39	2.49
Granular Fill	21	35	0.47	0.28	3.38

Notes:
Lateral coefficients of earth pressure assume a sloping ground surface behind the wall.
Parameters assume that the Granular Engineered Fills are placed and compacted according to Section 4.4.5.2

As soon as practicable after the installation of the retaining structure, areas disturbed during construction should be revegetated to minimize erosion potential and to promote stability. The existing trail should also be revegetated to discourage further public use.

4.5 SITE 3

Three conceptual options are proposed for Site 3, as follows:

- Option 1: Upgrading the existing single track trail adjacent to the main trail
- Option 2: Offsetting the main trail a minimal distance away from the creek
- Option 3: Rebuilding the existing main trail and armouring the bank of the creek

All of the proposed conceptual options for this site are considered geotechnically feasible. Stantec understands that the City does not currently have a preferred solution. Options 1 and 2

MILL CREEK RAVINE TRAIL REHABILITATION

Discussion and Recommendations
January 12, 2018

would allow the trail to remain open while allowing the creek to undergo its natural process. Option 3 provides a robust solution that would allow the existing trail to remain in place; however, significant changes to timelines would be necessary as a lengthy permitting process is anticipated for in-stream works. Further comparison of the options is provided in Stantec's Site Assessment and Design Analysis Report.

Subsurface soil conditions are favourable for all options. However, if design grades require excavation of the clayshale bedrock, the contractor may have difficulty excavating through this material depending on the size of equipment that is mobilized to site. This may be an issue with all three options.

Option 3 (bank restoration) is the preferred remediation method for this site. Additional details for all three options are presented in the following sections.

4.5.1 Options 1 and 2

Both Option 1 and 2 would require some degree of tree clearing, grading, and trail construction. The offset distance that the main trail can be realigned by is constrained by the bridge to the south, the toe of the ravine slope to the north, and the sight lines between them. The sight lines will need to be evaluated by the design team to assess the feasibility of these options.

The toe of the valley slope is located immediately north of the site. Any earth works provided for trail grading should avoid unnecessary excavation to minimize disturbance to the slope. The trail construction recommendations provided in **Section 4.2** should be followed at this site as well.

4.5.2 Option 3

For Option 3, appropriate erosion control and stream isolation measures should be implemented before construction begins. Erosion control and stream isolation measures are detailed in the Site Assessment and Design Analysis Report.

The existing trail should be re-built using a low to intermediate plastic clay fill or crushed granular material, such as COE Designation 3, Class 63 or similar. This material should be placed in horizontal lifts not exceeding 200 mm and compacted to 98% SPMDD at $\pm 3\%$ of OWC. The surface of the trail should comply with the geotechnical recommendations pertaining to minimum trail structure requirements provided in **Section 4.2**.

MILL CREEK RAVINE TRAIL REHABILITATION

Summary
January 12, 2018

5.0 SUMMARY

The proposed conceptual rehabilitation options for each of the sites are considered geotechnically feasible at this stage in the design. The choice of options should take into consideration the inherent slope instability along the Mill Creek Ravine, along with the other priorities identified by the City.

As noted above, as well as in the Draft Site Assessment and Design Analysis Report, the preferred options for each of the sites are as follows:

- Site 1: Offset the main trail away from the creek bank and tie into the existing single track trail;
- Site 2: Long radius trail realignment with retaining structure; and,
- Site 3: Bank restoration, leaving the existing trail alignment intact.

Any modifications to the conceptual or detailed designs should be reviewed by the Stantec Geotechnical team so the assumptions and recommendations provided herein can be updated as needed.

MILL CREEK RAVINE TRAIL REHABILITATION

Closure
January 12, 2018

6.0 CLOSURE

This report has been prepared for the sole benefit of the City of Edmonton, and may not be used by any third party without the express written consent of Stantec Consulting Ltd. Any use which a third party makes of this report is the responsibility of such third party. Use of this report is subject to the Statement of General Conditions provided in Appendix A. It is the responsibility of the City of Edmonton, who is identified as "the Client" within the Statement of General Conditions, and its agents to review the conditions and to notify Stantec should any of these not be satisfied.

We trust the above information meets with your present requirements. Should you have any questions or require further information, please contact the undersigned. Section 3.2 was prepared by Emma Reid, M.Sc. and reviewed by Sidney Tsang, P.Geotechnical (BC). Geotechnical components of this report were reviewed by Tom Crilly, M.Sc., P.Eng. (MB).

Regards,

STANTEC CONSULTING LTD.



Eric Leishman, M.Sc., E.I.T.
Geotechnical Engineer-in-Training
Tel: (587) 756-6230
Eric.Leishman@stantec.com



Emma Reid, M.Sc.
Terrain Scientist
Tel: (604) 412-3277
Emma.Reid@stantec.com



Carrie Murray, M.Eng., P.Eng.
Senior Geotechnical Engineer
Tel: (780) 917-7271
Carrie.Murray@stantec.com

MILL CREEK RAVINE TRAIL REHABILITATION

References

January 12, 2018

7.0 REFERENCES

Associated Engineering (2016). Mill Creek Erosion Study. Edmonton, Alberta. Report submitted to the City of Edmonton.

City of Edmonton Materials and Testing (1981). Boreholes at Mill Creek at 84 Avenue. File No. 931-36-09-09.

City of Edmonton. (2017). Design and Construction Standards, Volume 5, Landscaping.

Hardy BBT Ltd. (1990). Geotechnical Assessment, Slope Instability and Remedial Design, 76 Avenue at Mill Creek Ravine, Edmonton, Alberta. File No. EG-07131. Report submitted to the City of Edmonton.

Kathol, C.A. and R.A. McPherson. (1975). Urban Geology of Edmonton, Bulletin 32, Alberta Research Council.

Peters, N. and Lamb, K.N. (1979). Experiences with alluvial foundations for earth dams in the prairied provinces. *Canadian Geotechnical Journal*, 16(2), 255-271.

Pettapiece, W.W. (1986). Physiographic Subdivisions of Alberta 1:1,500,000. Land Resource Centre. Research Branch. Ottawa, Ontario.

Ruban, A.F., Patrick, R.A., and Skirrow, R. (2004). Approach fill design of North Saskatchewan River bridge. In 2009 Annual Conference and Exhibition of the Transportation Association of Canada-Transportation in a Climate of Change.

Thomson, S., and Yacyshyn, R. (1977). Slope instability in the City of Edmonton. *Canadian Geotechnical Journal*, 14(1), 1-16.

Thomson, S., and Tiedemann, C.E. (1982). A review of factors affecting landslides in urban areas. *Bull Assoc Eng Geol*, 19(1), 55-65.

Thurber Engineering Ltd. (2005). Condominium Development, Whyte Avenue and 93rd Street, Edmonton, Alberta, Top of Bank Set Back Assessment. File No. 19-4380-5. Report submitted to the City of Edmonton.

Appendix A
STATEMENT OF GENERAL CONDITIONS

STATEMENT OF GENERAL CONDITIONS

USE OF THIS REPORT: This report has been prepared for the sole benefit of the Client or its agent and may not be used by any third party without the express written consent of Stantec Consulting Ltd. and the Client. Any use which a third party makes of this report is the responsibility of such third party.

BASIS OF THE REPORT: The information, opinions, and/or recommendations made in this report are in accordance with Stantec Consulting Ltd.'s present understanding of the site specific project as described by the Client. The applicability of these is restricted to the site conditions encountered at the time of the investigation or study. If the proposed site specific project differs or is modified from what is described in this report or if the site conditions are altered, this report is no longer valid unless Stantec Consulting Ltd. is requested by the Client to review and revise the report to reflect the differing or modified project specifics and/or the altered site conditions.

STANDARD OF CARE: Preparation of this report, and all associated work, was carried out in accordance with the normally accepted standard of care in the state or province of execution for the specific professional service provided to the Client. No other warranty is made.

INTERPRETATION OF SITE CONDITIONS: Soil, rock, or other material descriptions, and statements regarding their condition, made in this report are based on site conditions encountered by Stantec Consulting Ltd. at the time of the work and at the specific testing and/or sampling locations. Classifications and statements of condition have been made in accordance with normally accepted practices which are judgmental in nature; no specific description should be considered exact, but rather reflective of the anticipated material behavior. Extrapolation of in situ conditions can only be made to some limited extent beyond the sampling or test points. The extent depends on variability of the soil, rock and groundwater conditions as influenced by geological processes, construction activity, and site use.

VARYING OR UNEXPECTED CONDITIONS: Should any site or subsurface conditions be encountered that are different from those described in this report or encountered at the test locations, Stantec Consulting Ltd. must be notified immediately to assess if the varying or unexpected conditions are substantial and if reassessments of the report conclusions or recommendations are required. Stantec Consulting Ltd. will not be responsible to any party for damages incurred as a result of failing to notify Stantec Consulting Ltd. that differing site or sub-surface conditions are present upon becoming aware of such conditions.

PLANNING, DESIGN, OR CONSTRUCTION: Development or design plans and specifications should be reviewed by Stantec Consulting Ltd., sufficiently ahead of initiating the next project stage (property acquisition, tender, construction, etc), to confirm that this report completely addresses the elaborated project specifics and that the contents of this report have been properly interpreted. Specialty quality assurance services (field observations and testing) during construction are a necessary part of the evaluation of sub-subsurface conditions and site preparation works. Site work relating to the recommendations included in this report should only be carried out in the presence of a qualified geotechnical engineer; Stantec Consulting Ltd. cannot be responsible for site work carried out without being present.

Appendix B FIGURES

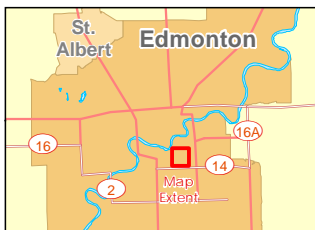

- Approximate Site Location
- Quarter Section

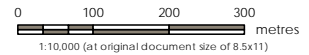

Project Location 1161106255
 Part of SE 33 and E 28-052-24 W4M Prepared by MK on 2017-08-23
 Edmonton, Alberta Quality Review by LF on 2017-08-23
 Approved by CDM on 2017-10-10

Client/Project
 City of Edmonton
 Mill Creek Ravine Trail Rehabilitation

Figure No.
 1

Title
 Site Location Plan

- Notes
1. Coordinate System: NAD 1983 31M 114
 2. Base features: Geogratis, ©Department of Natural Resources Canada, All rights reserved.
 3. Imagery: City of Edmonton, 2015.

Disclaimer: Stantec assumes no responsibility for data supplied in electronic format. The recipient accepts full responsibility for verifying the accuracy and completeness of the data. The recipient releases Stantec, its officers, employees, consultants and agents from any and all claims arising in any way from the content or provision of the data.

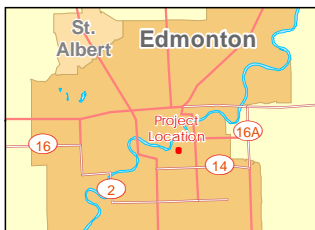
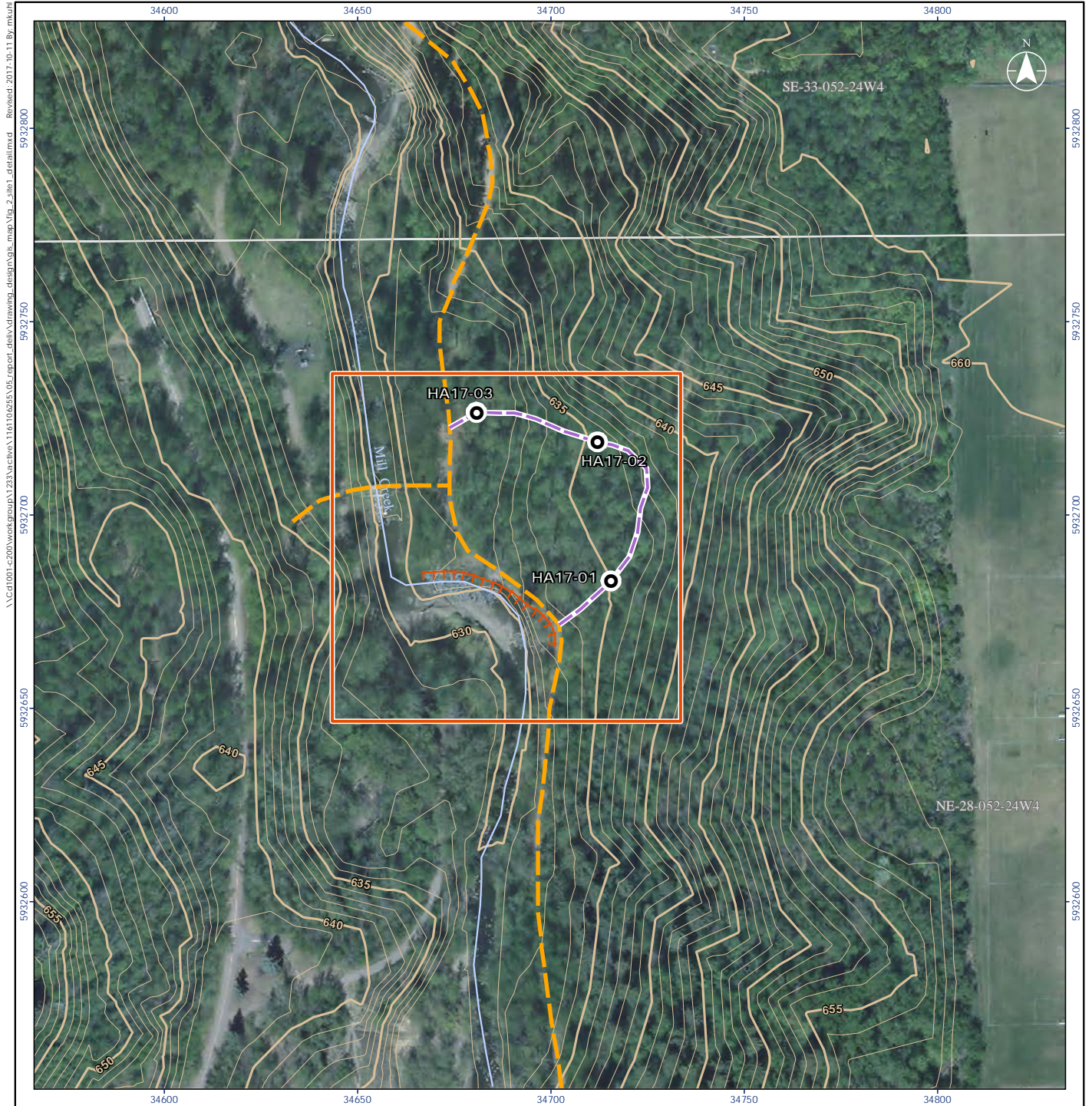

- Study Area
- Hand Auger Location
- Main Trail
- Scarp
- Secondary Trail
- Creek
- Ground Elevation Contour (Major, m AMSL)
- Ground Elevation Contour (Minor, m AMSL)
- Contour Interval = 1.0 m
- Quarter Section



Project Location 1161106255
 Part of SE 33 and E 28-052-24 W4M Prepared by MK on 2017-08-23
 Edmonton, Alberta Quality Review by LF on 2017-08-23
 Approved by CDM on 2017-10-10

Client/Project
 City of Edmonton
 Mill Creek Ravine Trail Rehabilitation

Figure No.
 2

Title
 Site Plan Showing Hand Auger Locations (Site 1)

- Notes
1. Coordinate System: NAD 1983 31M 114
 2. Base Features: Geogratis, ©Department of Natural Resources Canada. All rights reserved. Contours: City of Edmonton, 2016.
 3. Imagery: City of Edmonton, 2015.

m AMSL - metres above mean sea level

Disclaimer: Stantec assumes no responsibility for data supplied in electronic format. The recipient accepts full responsibility for verifying the accuracy and completeness of the data. The recipient releases Stantec, its officers, employees, consultants and agents from any and all claims arising in any way from the content or provision of the data.

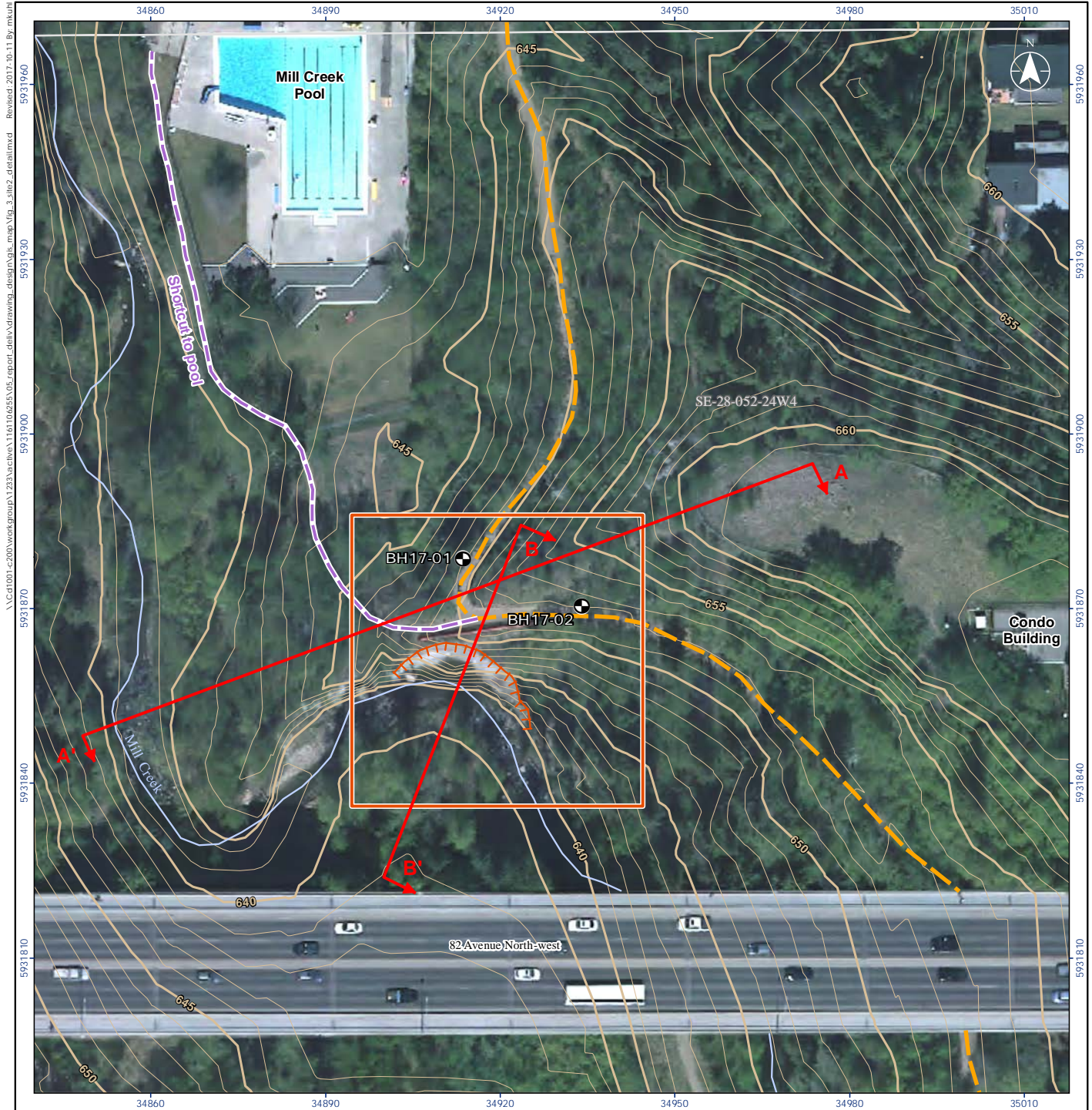

\\Cd1001-c200\workgroup\1233\alves\1161106255\05_report_dev\drawing_design\sls_msp_Vig_3_sl02_detailed.mxd Revised: 2017-10-11 By: mkh
 5931960
 5931930
 5931900
 5931870
 5931840
 5931810

5931960
 5931930
 5931900
 5931870
 5931840
 5931810

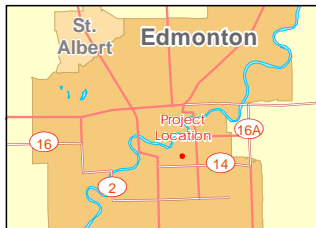

- Study Area
- Borehole Location
- Cross Section
- Main Trail
- Secondary Trail
- Creek
- Ground Elevation Contour (Major, m AMSL)
- Ground Elevation Contour (Minor, m AMSL)
- Contour Interval = 1.0 m
- Quarter Section

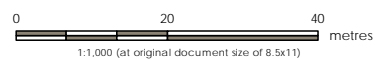

Project Location: 1161106255
 Part of SE 33 and E 28-052-24 W4M Prepared by MK on 2017-08-23
 Edmonton, Alberta Quality Review by LF on 2017-08-23
 Approved by CDM on 2017-10-10

Client/Project:
 City of Edmonton
 Mill Creek Ravine Trail Rehabilitation

Figure No. 3
 Title

- Notes
1. Coordinate System: NAD 1983 31M 114
 2. Base Features: Geogratis, ©Department of Natural Resources Canada. All rights reserved. Contours: City of Edmonton, 2016.
 3. Imagery: City of Edmonton, 2015.

Disclaimer: Stantec assumes no responsibility for data supplied in electronic format. The recipient accepts full responsibility for verifying the accuracy and completeness of the data. The recipient releases Stantec, its officers, employees, consultants and agents from any and all claims arising in any way from the content or provision of the data.

Site Plan Showing Borehole and Cross Section Location (Site 2)



\\Cd1001-c200\workgroup\1233\calico\1161106255\05_report_dev\drawing_design\site_map_Vig_4_sht3_detailed.mxd Revised: 2017-10-11 By: mkh
 5931400
 5931350
 5931300
 5931250
 5931200
 5931150

5931400
 5931350
 5931300
 5931250
 5931200
 5931150

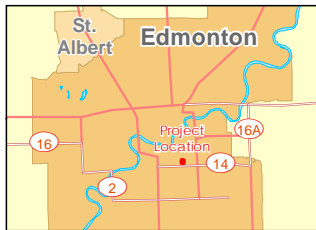

- Study Area
- Borehole Location
- Main Trail
- Scarp
- Creek
- Ground Elevation Contour (Major, m AMSL)
- Ground Elevation Contour (Minor, m AMSL)
- Contour Interval = 1.0 m
- Quarter Section

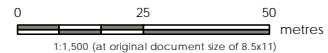

Project Location: 1161106255
 Part of SE 33 and E 28-052-24 W4M Prepared by MK on 2017-08-23
 Edmonton, Alberta Quality Review by LF on 2017-08-23
 Approved by CDM on 2017-10-10

Client/Project:
 City of Edmonton
 Mill Creek Ravine Trail Rehabilitation

Figure No.
4

Title
Site Plan Showing Borehole Locations (Site 3)

Notes
 1. Coordinate System: NAD 1983 31M 114
 2. Base Features: Geogratis, ©Department of Natural Resources Canada. All rights reserved. Contours: City of Edmonton, 2016.
 3. Imagery: City of Edmonton, 2015.

m AMSL - metres above mean sea level

Disclaimer: Stantec assumes no responsibility for data supplied in electronic format. The recipient accepts full responsibility for verifying the accuracy and completeness of the data. The recipient releases Stantec, its officers, employees, consultants and agents from any and all claims arising in any way from the content or provision of the data.

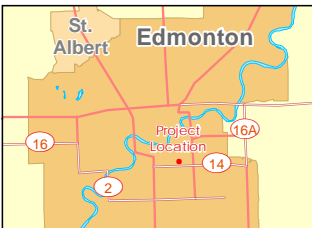
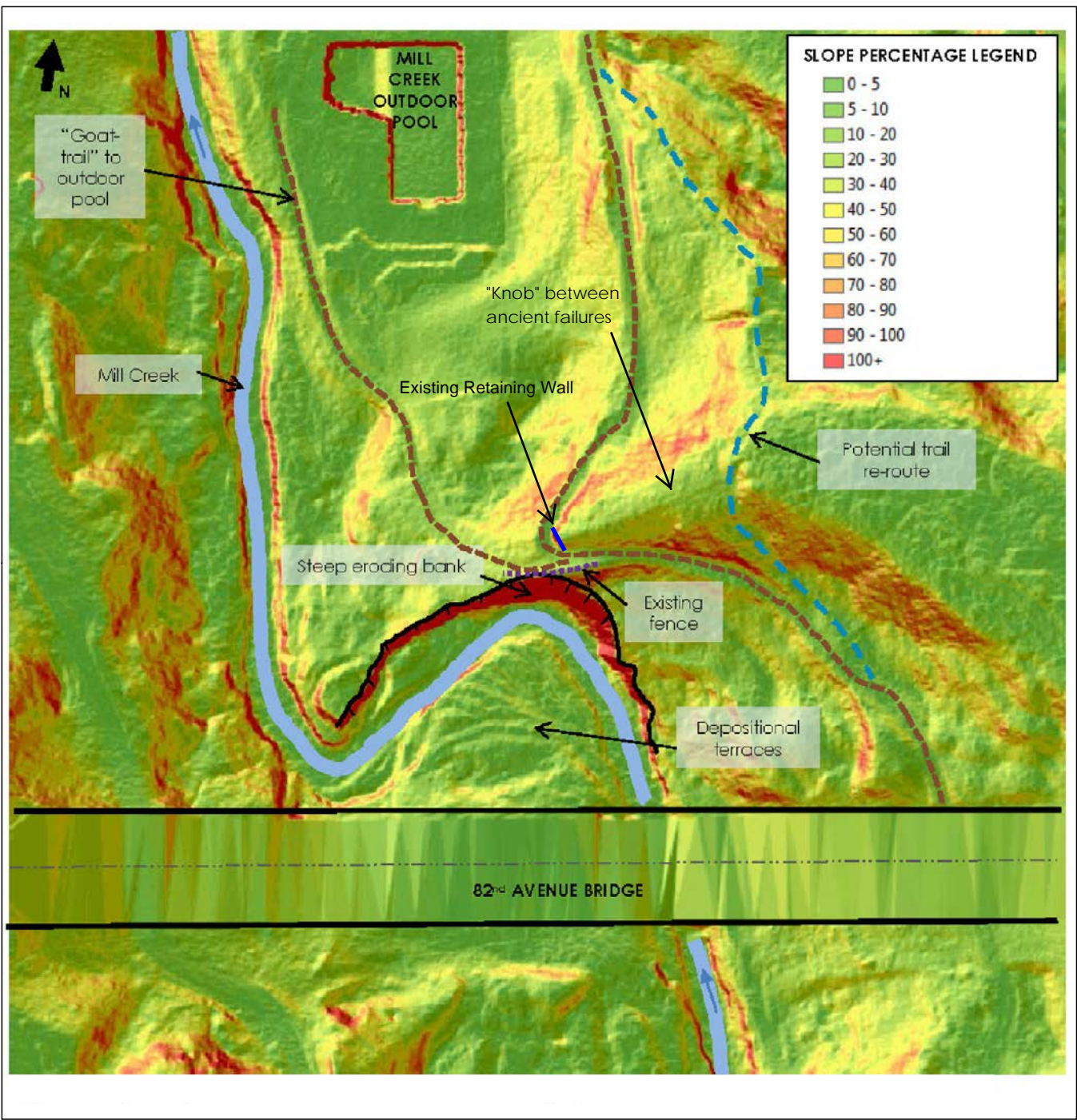

Notes
 1. Slope map of site 2 overlaid on a hillshade image produced from 30 cm resolution LIDAR data (Source: Stantec, Geotechnical Engineering).



Project Location: 1161106255
 Part of SE 33 and E 28-052-24 W4M Prepared by MK on 2017-08-28
 Edmonton, Alberta Quality Review by LF on 2017-08-28
 Approved by CDM on 2017-10-10

Client/Project
 City of Edmonton
 Mill Creek Ravine Trail Rehabilitation

Figure No.
 5

Title
 Slope Map of Site 2

Disclaimer: Stantec assumes no responsibility for data supplied in electronic format. The recipient accepts full responsibility for verifying the accuracy and completeness of the data. The recipient releases Stantec, its officers, employees, consultants and agents, from any and all claims arising in any way from the content or provision of the data.

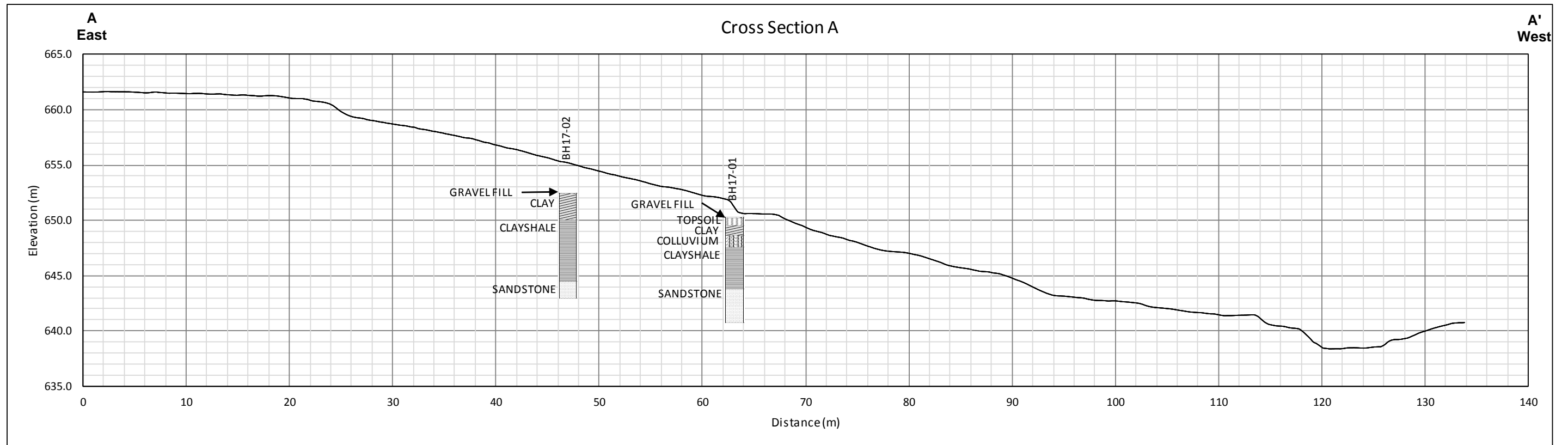

\\C:\001-c200\workgroup\1233\acbrva\116106255\05\report_deliv\drawing_design\gis_map\fig_6_sectionA_s1a2.mxd
 Revised: 2017-10-11 By: mkulh

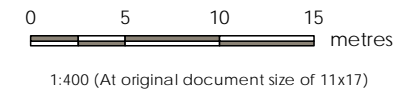
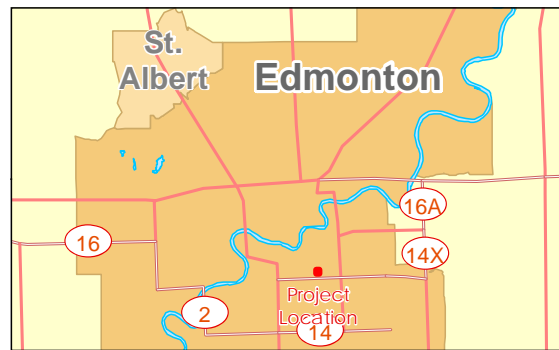

Project Location: Part of SE 33 and E 28-052-24 W4M, Edmonton, Alberta
 Prepared by MK on 2017-08-28
 Quality Review by LF on 2017-08-28
 Approved by CDM on 2017-10-10
 1161106255

Client/Project:
 City of Edmonton
 Mill Creek Ravine Trail Rehabilitation

Figure No.
6

Title
Cross Section A
(Site 2)

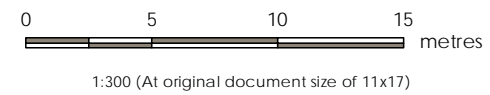
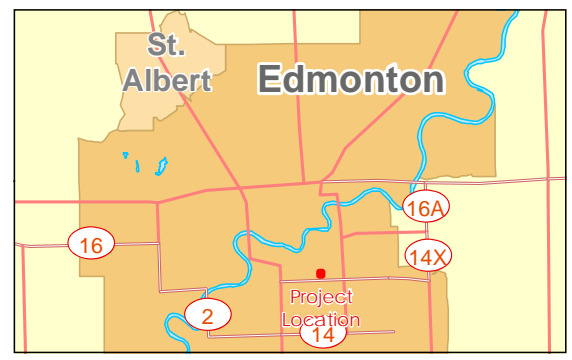
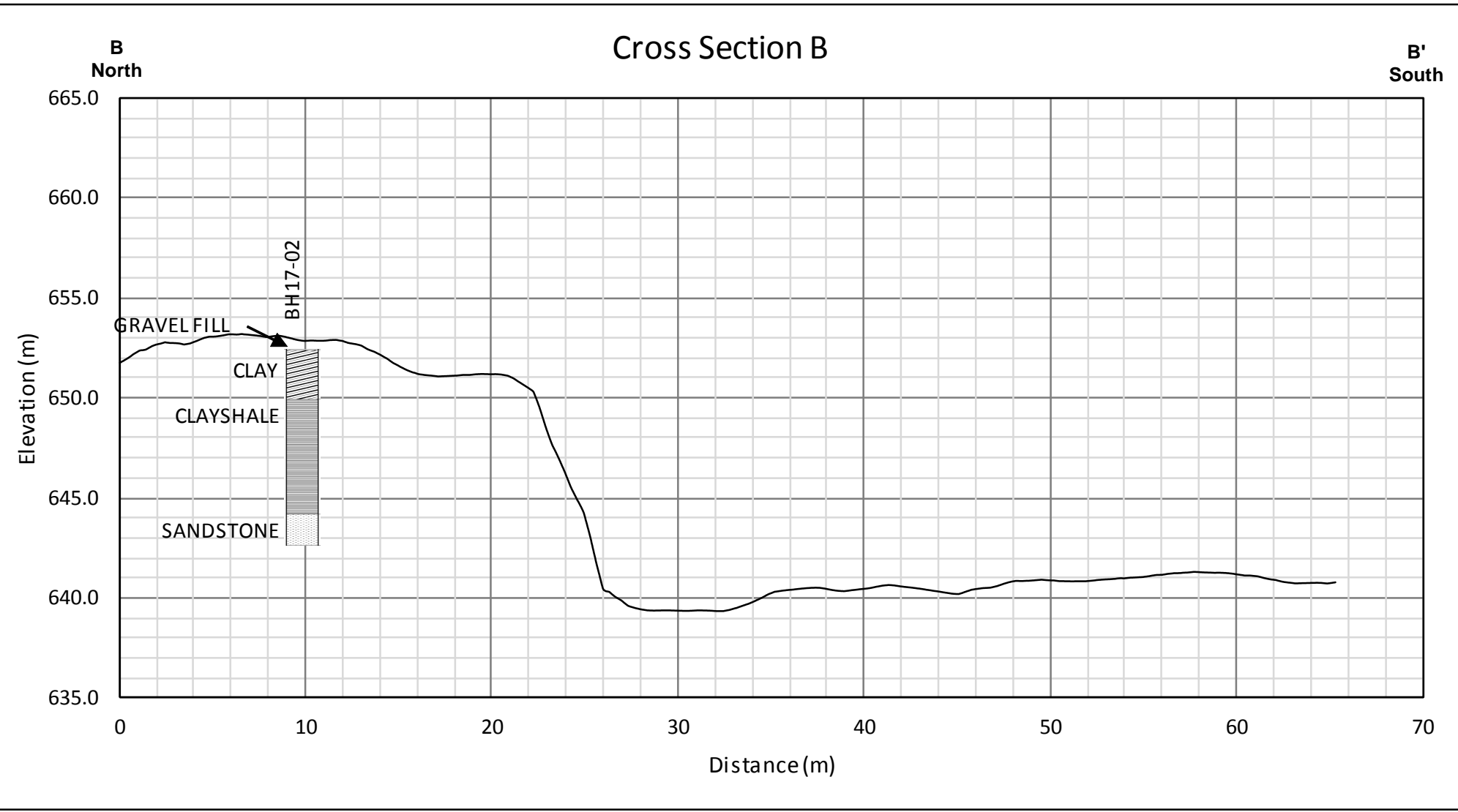

Project Location: Part of SE 33 and E 28-052-24 W4M, Edmonton, Alberta
 Prepared by MK on 2017-08-28
 Quality Review by LF on 2017-08-28
 Approved by CDM on 2017-10-10

Client/Project: City of Edmonton, Mill Creek Ravine Trail Rehabilitation

Figure No.: 7

Title: Cross Section B (Site 2)

\\c:\d001-c200\workgroup\1233\acbrva\116106255\05_report_del\drawing_design\gis_map\fig_7_sectionB_81a2.mxd Revised: 2017-10-11 By: mkulh

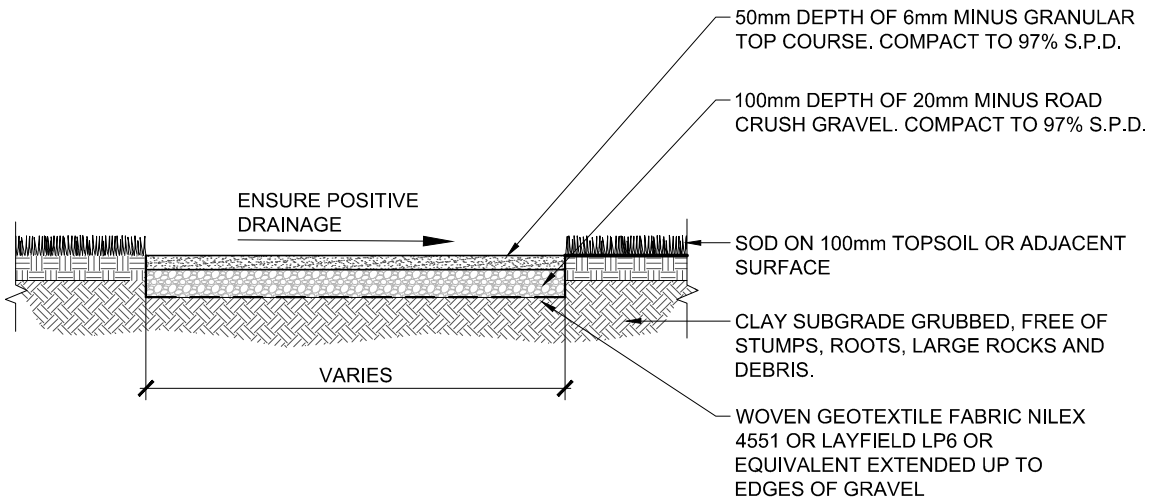

GRANULAR CROSS SECTION (TYP.)

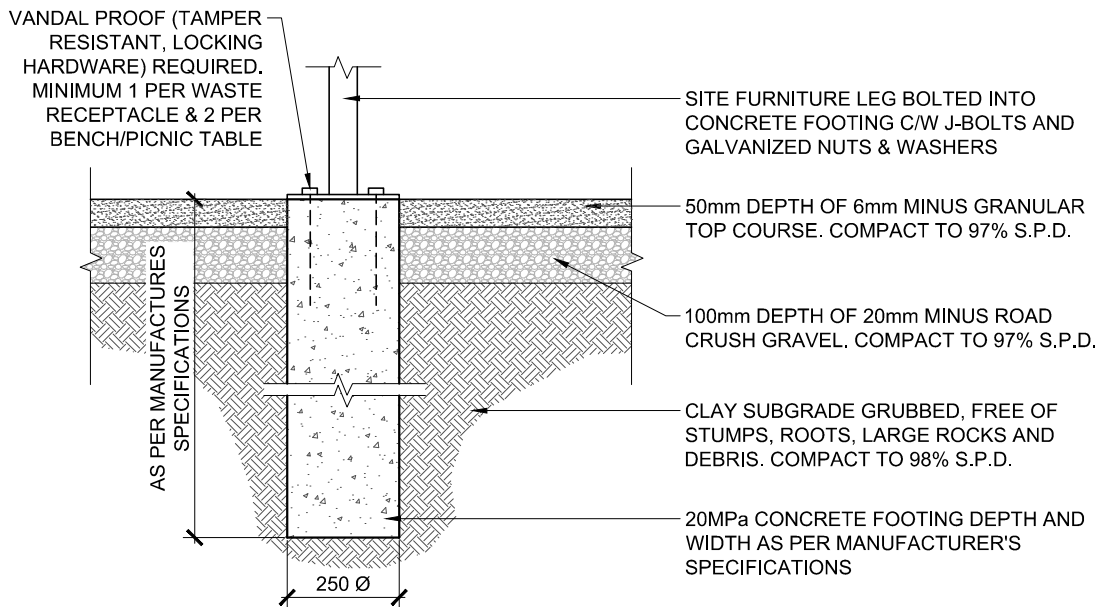

SITE FURNITURE FOOTING WITHIN GRANULAR AREA

NOTES:

- DIMENSIONS OF GRANULAR WALKWAY OR PLAZA AS PER LANDSCAPE DRAWINGS.
- SET GRANULAR SURFACE FLUSH WITH ADJACENT GRADES.
- ENSURE DRAINAGE OFF GRANULAR AT ALL LOCATIONS & IN COMPLIANCE WITH THE OVERALL SITE DRAINAGE PLAN.
- 20mm MINUS GRANULAR - SECTION 2060 AGGREGATE DESIGNATION 3, CLASS 20A, COMPACT TO 97% S.P.D.



GRANULAR WALKWAY

Date Approved: SEPT 2013	Drawn By: PARKS PLANNING	Approved: 	Revision	Drawing No. LA303
Scale: N.T.S.	Checked By: PARKS PLANNING			Old Drawing No. -

Appendix C
SELECT SITE PHOTOGRAPHS

Mill Creek Ravine Trail Rehabilitation
Site Photos



Photo 1: Site 1; eroded right bank of Mill Creek (facing east)



Photo 2: Site 1; impact of erosion on trail (facing northwest)

Mill Creek Ravine Trail Rehabilitation
Site Photos



Photo 3: Site 1; existing secondary single track trail east of main trail



Photo 4: Site 2; existing retaining wall at toe of 5H:1V slope (facing northeast, taken November 19, 2016)

Mill Creek Ravine Trail Rehabilitation
Site Photos



Photo 5: Site 2; eroding bank below trail (facing north, taken November 19, 2016)



Photo 6: Site 3; eroded bank impacting trail (facing northeast)

Mill Creek Ravine Trail Rehabilitation
Site Photos



Photo 7: Site 3; eroded bank impacting trail at right of photo, intersection with single track trail at left of photo (facing south)

Appendix D
SITE 2 AERIAL PHOTOGRAPHS

Mill Creek Ravine Trail Rehabilitation
Site 2: Air Photo Review



Air Photo 1: 1962



Air Photo 2: 1972

Mill Creek Ravine Trail Rehabilitation
Site 2: Air Photo Review



Air Photo 3: 1987



Air Photo 4: 1993

Mill Creek Ravine Trail Rehabilitation
Site 2: Air Photo Review



Air Photo 5: 2002

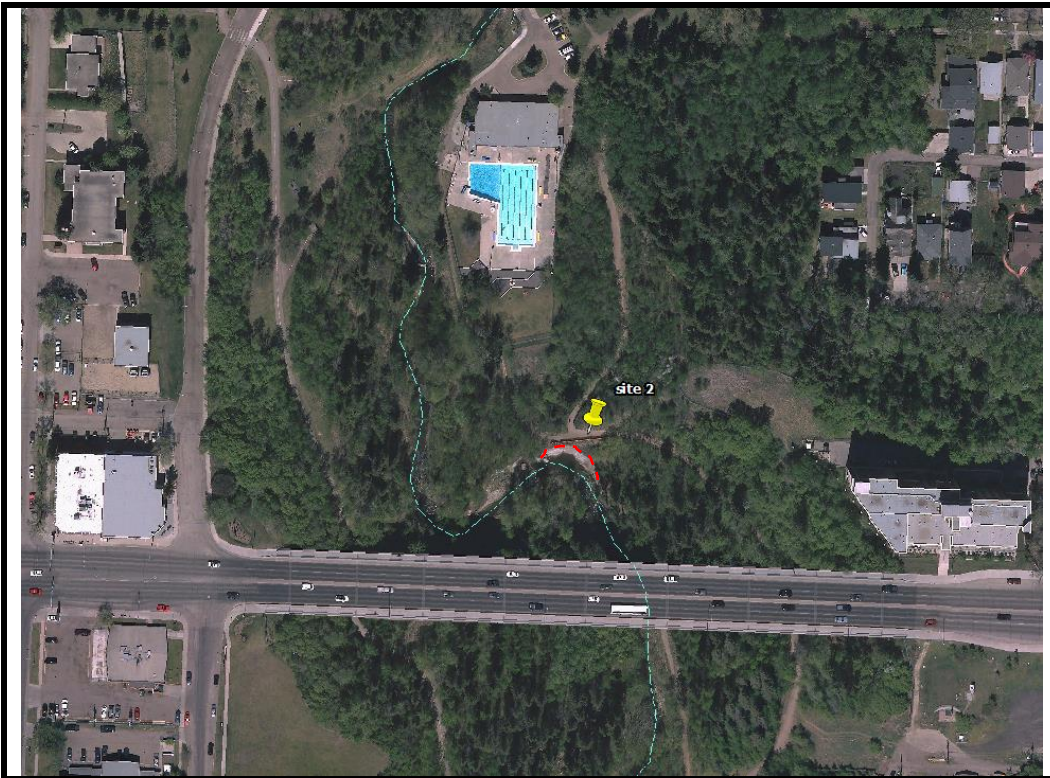

Air Photo 6: 2015

Appendix E
BOREHOLE RECORD TERMS AND SYMBOLS
BOREHOLE RECORDS

SYMBOLS AND TERMS USED ON BOREHOLE AND TEST PIT RECORDS

SOIL DESCRIPTION

Terminology describing common soil genesis:

<i>Rootmat</i>	- vegetation, roots and moss with organic matter and topsoil typically forming a mattress at the ground surface
<i>Topsoil</i>	- mixture of soil and humus capable of supporting vegetative growth
<i>Peat</i>	- mixture of visible and invisible fragments of decayed organic matter
<i>Till</i>	- unstratified glacial deposit which may range from clay to boulders
<i>Fill</i>	- material below the surface identified as placed by humans (excluding buried services)

Terminology describing soil structure:

<i>Desiccated</i>	- having visible signs of weathering by oxidization of clay minerals, shrinkage cracks, etc.
<i>Fissured</i>	- having cracks, and hence a blocky structure
<i>Varved</i>	- composed of regular alternating layers of silt and clay
<i>Stratified</i>	- composed of alternating successions of different soil types, e.g. silt and sand
<i>Layer</i>	- > 75 mm in thickness
<i>Seam</i>	- 2 mm to 75 mm in thickness
<i>Parting</i>	- < 2 mm in thickness

Terminology describing soil types:

The classification of soil types are made on the basis of grain size and plasticity in accordance with the Prairie Farm Rehabilitation Association (PFRA) Modified version of the Unified Soil Classification System (USCS) which excludes particles larger than 75 mm. For particles larger than 75 mm, and for defining percent clay fraction in hydrometer results, definitions proposed by Canadian Foundation Engineering Manual, 4th Edition are used. See page 4 for definitions and other details.

Terminology describing cobbles, boulders, and non-matrix materials (organic matter or debris):

Terminology describing materials outside of the PFRA Modified version of the USCS, (e.g. particles larger than 75 mm, visible organic matter, and construction debris) is based upon the proportion of these materials present:

<i>Trace, or occasional</i>	Less than 10%
<i>Some</i>	10-20%
<i>Frequent</i>	> 20%

Terminology describing compactness of cohesionless soils:

The standard terminology to describe cohesionless soils includes compactness (formerly "relative density"), as determined by the Standard Penetration Test N-Value - also known as N-Index. The SPT N-Value is described further on page 3. A relationship between compactness condition and N-Value is shown in the following table.

Compactness Condition	SPT N-Value
<i>Very Loose</i>	<4
<i>Loose</i>	4-10
<i>Compact</i>	10-30
<i>Dense</i>	30-50
<i>Very Dense</i>	>50

Terminology describing consistency of cohesive soils:

The standard terminology to describe cohesive soils includes the consistency, which is based on undrained shear strength as measured by *in situ* vane tests, penetrometer tests, or unconfined compression tests. Consistency may be crudely estimated from SPT N-Value based on the correlation shown in the following table (Terzaghi and Peck, 1967). The correlation to SPT N-Value is used with caution as it is only very approximate.

Consistency	Undrained Shear Strength		Approximate SPT N-Value
	kips/sq.ft.	kPa	
<i>Very Soft</i>	<0.25	<12.5	<2
<i>Soft</i>	0.25 - 0.5	12.5 - 25	2-4
<i>Firm</i>	0.5 - 1.0	25 - 50	4-8
<i>Stiff</i>	1.0 - 2.0	50 - 100	8-15
<i>Very Stiff</i>	2.0 - 4.0	100 - 200	15-30
<i>Hard</i>	>4.0	>200	>30

ROCK DESCRIPTION

Except where specified below, terminology for describing rock is as defined by the International Society for Rock Mechanics (ISRM) 2007 publication "The Complete ISRM Suggested Methods for Rock Characterization, Testing and Monitoring: 1974-2006"

Terminology describing rock quality:

RQD	Rock Mass Quality
0-25	Very Poor Quality
25-50	Poor Quality
50-75	Fair Quality
75-90	Good Quality
90-100	Excellent Quality

Alternate (Colloquial) Rock Mass Quality	
Very Severely Fractured	Crushed
Severely Fractured	Shattered or Very Blocky
Fractured	Blocky
Moderately Jointed	Sound
Intact	Very Sound

RQD (Rock Quality Designation) denotes the percentage of intact and sound rock retrieved from a borehole of any orientation. All pieces of intact and sound rock core equal to or greater than 100 mm (4 in.) long are summed and divided by the total length of the core run. RQD is determined in accordance with ASTM D6032.

SCR (Solid Core Recovery) denotes the percentage of solid core (cylindrical) retrieved from a borehole of any orientation. All pieces of solid (cylindrical) core are summed and divided by the total length of the core run (It excludes all portions of core pieces that are not fully cylindrical as well as crushed or rubble zones).

Fracture Index (FI) is defined as the number of naturally occurring fractures within a given length of core. The Fracture Index is reported as a simple count of natural occurring fractures.

Terminology describing rock with respect to discontinuity and bedding spacing:

Spacing (mm)	Discontinuities	Bedding
>6000	Extremely Wide	-
2000-6000	Very Wide	Very Thick
600-2000	Wide	Thick
200-600	Moderate	Medium
60-200	Close	Thin
20-60	Very Close	Very Thin
<20	Extremely Close	Laminated
<6	-	Thinly Laminated

Terminology describing rock strength:

Strength Classification	Grade	Unconfined Compressive Strength (MPa)
Extremely Weak	R0	<1
Very Weak	R1	1 – 5
Weak	R2	5 – 25
Medium Strong	R3	25 – 50
Strong	R4	50 – 100
Very Strong	R5	100 – 250
Extremely Strong	R6	>250

Terminology describing rock weathering:

Term	Symbol	Description
Fresh	W1	No visible signs of rock weathering. Slight discoloration along major discontinuities
Slightly	W2	Discoloration indicates weathering of rock on discontinuity surfaces. All the rock material may be discolored.
Moderately	W3	Less than half the rock is decomposed and/or disintegrated into soil.
Highly	W4	More than half the rock is decomposed and/or disintegrated into soil.
Completely	W5	All the rock material is decomposed and/or disintegrated into soil. The original mass structure is still largely intact.
Residual Soil	W6	All the rock converted to soil. Structure and fabric destroyed.

STRATA PLOT

Strata plots symbolize the soil or bedrock description. They are combinations of the following basic symbols. The dimensions within the strata symbols are not indicative of the particle size, layer thickness, etc.

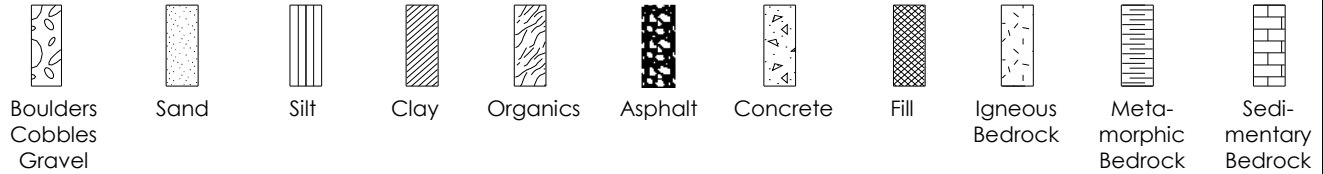

SAMPLE TYPE

SS	Split spoon sample (obtained by performing the Standard Penetration Test)
ST	Shelby tube or thin wall tube
DP	Direct-Push sample (small diameter tube sampler hydraulically advanced)
PS	Piston sample
BS	Bulk sample
WS	Wash sample
HQ, NQ, BQ, etc.	Rock core samples obtained with the use of standard size diamond coring bits.

WATER LEVEL MEASUREMENT

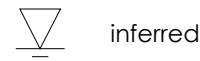
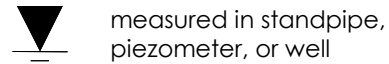

RECOVERY

For soil samples, the recovery is recorded as the length of the soil sample recovered. For rock core, recovery is defined as the total cumulative length of all core recovered in the core barrel divided by the length drilled and is recorded as a percentage on a per run basis.

N-VALUE

Numbers in this column are the field results of the Standard Penetration Test: the number of blows of a 140 pound (63.5 kg) hammer falling 30 inches (760 mm), required to drive a 2 inch (50.8 mm) O.D. split spoon sampler one foot (300 mm) into the soil. In accordance with ASTM D1586, the N-Value equals the sum of the number of blows (N) required to drive the sampler over the interval of 6 to 18 in. (150 to 450 mm). However, when a 24 in. (610 mm) sampler is used, the number of blows (N) required to drive the sampler over the interval of 12 to 24 in. (300 to 610 mm) may be reported if this value is lower. For split spoon samples where insufficient penetration was achieved and N-Values cannot be presented, the number of blows are reported over sampler penetration in millimetres (e.g. 50/75). Some design methods make use of N-values corrected for various factors such as overburden pressure, energy ratio, borehole diameter, etc. No corrections have been applied to the N-values presented on the log.

DYNAMIC CONE PENETRATION TEST (DCPT)

Dynamic cone penetration tests are performed using a standard 60 degree apex cone connected to 'A' size drill rods with the same standard fall height and weight as the Standard Penetration Test. The DCPT value is the number of blows of the hammer required to drive the cone one foot (305 mm) into the soil. The DCPT is used as a probe to assess soil variability.

OTHER TESTS

S	Sieve analysis
H	Hydrometer analysis
k	Laboratory permeability
γ	Unit weight
G_s	Specific gravity of soil particles
CD	Consolidated drained triaxial
CU	Consolidated undrained triaxial with pore pressure measurements
UU	Unconsolidated undrained triaxial
DS	Direct Shear
C	Consolidation
Q_u	Unconfined compression
I_p	Point Load Index (I_p on Borehole Record equals $I_p(50)$ in which the index is corrected to a reference diameter of 50 mm)

	Single packer permeability test; test interval from depth shown to bottom of borehole
	Double packer permeability test; test interval as indicated
	Falling head permeability test using casing
	Falling head permeability test using well point or piezometer

MODIFIED UNIFIED CLASSIFICATION SYSTEM FOR SOILS

MAJOR DIVISION		GROUP SYMBOL	TYPICAL DESCRIPTION	LABORATORY CLASSIFICATION CRITERIA		
COARSE GRAINED SOILS	GRAVELS (MORE THAN HALF COARSE GRAINS LARGER THAN 4.75 mm)	CLEAN GRAVELS (LITTLE OR NO FINES)	GW	WELL GRADED GRAVELS, LITTLE OR NO FINES	$C_u = \frac{D_{60}}{D_{10}} > 4; C_c = \frac{(D_{30})^2}{D_{10} \times D_{60}} = 1 \text{ to } 3$	
		GRAVELS WITH FINES	GP	POORLY GRADED GRAVELS AND GRAVEL-SAND MIXTURES, LITTLE OR NO FINES	NOT MEETING ABOVE REQUIREMENTS	
			GM	SILTY GRAVELS, GRAVEL-SAND-SILT MIXTURES	CONTENT OF FINES EXCEEDS 12%	ATTERBERG LIMITS BELOW 'A' LINE OR P.I. LESS THAN 4
		GC	CLAYEY GRAVELS, GRAVEL-SAND-CLAY MIXTURES	ATTERBERG LIMITS ABOVE 'A' LINE OR P.I. MORE THAN 7		
	SANDS (MORE THAN HALF COARSE GRAINS SMALLER THAN 4.75 mm)	CLEAN SANDS (LITTLE OR NO FINES)	SW	WELL GRADED SANDS, GRAVELLY SANDS, LITTLE OR NO FINES	$C_u = \frac{D_{60}}{D_{10}} > 6; C_c = \frac{(D_{30})^2}{D_{10} \times D_{60}} = 1 \text{ to } 3$	
		SANDS WITH FINES	SP	POORLY GRADED SANDS, LITTLE OR NO FINES	NOT MEETING ABOVE REQUIREMENTS	
			SM	SILTY SANDS, SAND-SILT MIXTURES	CONTENT OF FINES EXCEEDS 12%	ATTERBERG LIMITS BELOW 'A' LINE OR P.I. LESS THAN 4
		SC	CLAYEY SANDS, SAND-CLAY MIXTURES	ATTERBERG LIMITS ABOVE 'A' LINE OR P.I. MORE THAN 7		
FINE GRAINED SOILS	SILTS (BELOW 'A' LINE NEGLIGIBLE ORGANIC CONTENT)	$W_L < 50$	ML	INORGANIC SILTS AND VERY FINE SANDS, ROCK FLOUR, SILTY SANDS OF SLIGHT PLASTICITY	CLASSIFICATION IS BASED UPON PLASTICITY CHART (SEE BELOW) Note: WHENEVER THE NATURE OF THE FINE CONTENT HAS NOT BEEN DETERMINED, IT IS DESIGNATED BY THE LETTER 'F'. E.G. SF IS A MIXTURE OF SAND WITH SILT OR CLAY	
		$W_L > 50$	MH	INORGANIC SILTS, MICACEOUS OR DIATOMACEOUS FINE SANDY OR SILTY SOILS		
	CLAYS (ABOVE 'A' LINE NEGLIGIBLE ORGANIC CONTENT)	$W_L < 30$	CL	INORGANIC CLAYS OF LOW PLASTICITY GRAVELLY, SANDY, OR SILTY CLAYS, LEAN CLAYS		
		$30 < W_L < 50$	CI	INORGANIC CLAYS OF MEDIUM PLASTICITY, SILTY CLAYS		
		$W_L > 50$	CH	INORGANIC CLAYS OF HIGH PLASTICITY, FAT CLAYS		
	ORGANIC SILTS & CLAYS (BELOW 'A' LINE)	$W_L < 50$	OL	ORGANIC SILTS AND ORGANIC SILTY CLAYS OF LOW PLASTICITY		
		$W_L > 50$	OH	ORGANIC CLAYS OF HIGH PLASTICITY		
	HIGHLY ORGANIC SOILS		Pt	PEAT AND OTHER HIGHLY ORGANIC SOILS		
BEDROCK		BR	SEE REPORT DESCRIPTION			

NOTE: BOUNDARY CLASSIFICATION POSSESSING CHARACTERISTICS OF TWO GROUPS ARE GIVEN GROUP SYMBOLS, E.G. GW-GC IS A WELL GRADED GRAVEL MIXTURE WITH CLAY BINDER BETWEEN 5% AND 12%.

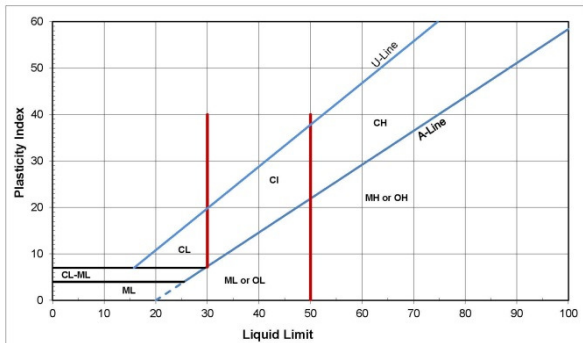

NOTE: PLASTICITY CHART IS FOR SOILS PASSING 425 µm SIEVE

SOIL COMPONENTS BY PARTICLE SIZE DISTRIBUTION

FRACTION	SIEVE SIZE (mm)		DEFINING RANGES OF PERCENTAGE BY WEIGHT OF MINOR COMPONENTS		
	PASSING	RETAINED	PERCENT	IDENTIFIER	
GRAVEL	COARSE	75	19	50 - 35	AND
	FINE	19	4.75		
SAND	COARSE	4.75	2.00	35 - 20	___Y/EY
	MEDIUM	2	0.425		
	FINE	0.425	0.075		
SILT (non-plastic) OR CLAY (plastic)	0.075		20 - 10	SOME	
OVERSIZE MATERIALS					
ROUNDED OR SUB-ROUNDED COBBLES 75 mm to 200 mm BOULDERS > 200 mm			ANGULAR ROCK FRAGMENTS ROCKS > 0.75 m ³ IN VOLUME		

NOTE: ALL SIEVE SIZES ARE REFERENCED TO U.S. STANDARD ASTM E.11 - ALTERNATE EQUIVALENT METRIC SIEVE SIZES IN ACCORDANCE WITH CGSB SPEC. 8-GP-2M TO APPLY WHEN PRESCRIBED

PROJECT: Mill Creek Ravine Trail	DRILLING CONTRACTOR: All Service Drilling	BOREHOLE NO: BH17-01				
CLIENT: City of Edmonton	UTM GRID: - N5932817 E336008 (± 5 m)	PROJECT NO: 1161106255				
START DATE: 8/1/17	12 U	ELEVATION: 650.3 m Geodetic				
SAMPLE TYPE	<input checked="" type="checkbox"/> Shelby Tube	<input type="checkbox"/> Drive Sample	<input type="checkbox"/> Auger Sample	<input type="checkbox"/> No Recovery	<input type="checkbox"/> A Casing	<input type="checkbox"/> Cored Sample
BACKFILL TYPE	<input checked="" type="checkbox"/> BENTONITE	<input type="checkbox"/> PEA GRAVEL	<input type="checkbox"/> SLOUGH	<input type="checkbox"/> GROUT	<input type="checkbox"/> DRILL CUTTINGS	<input type="checkbox"/> SAND

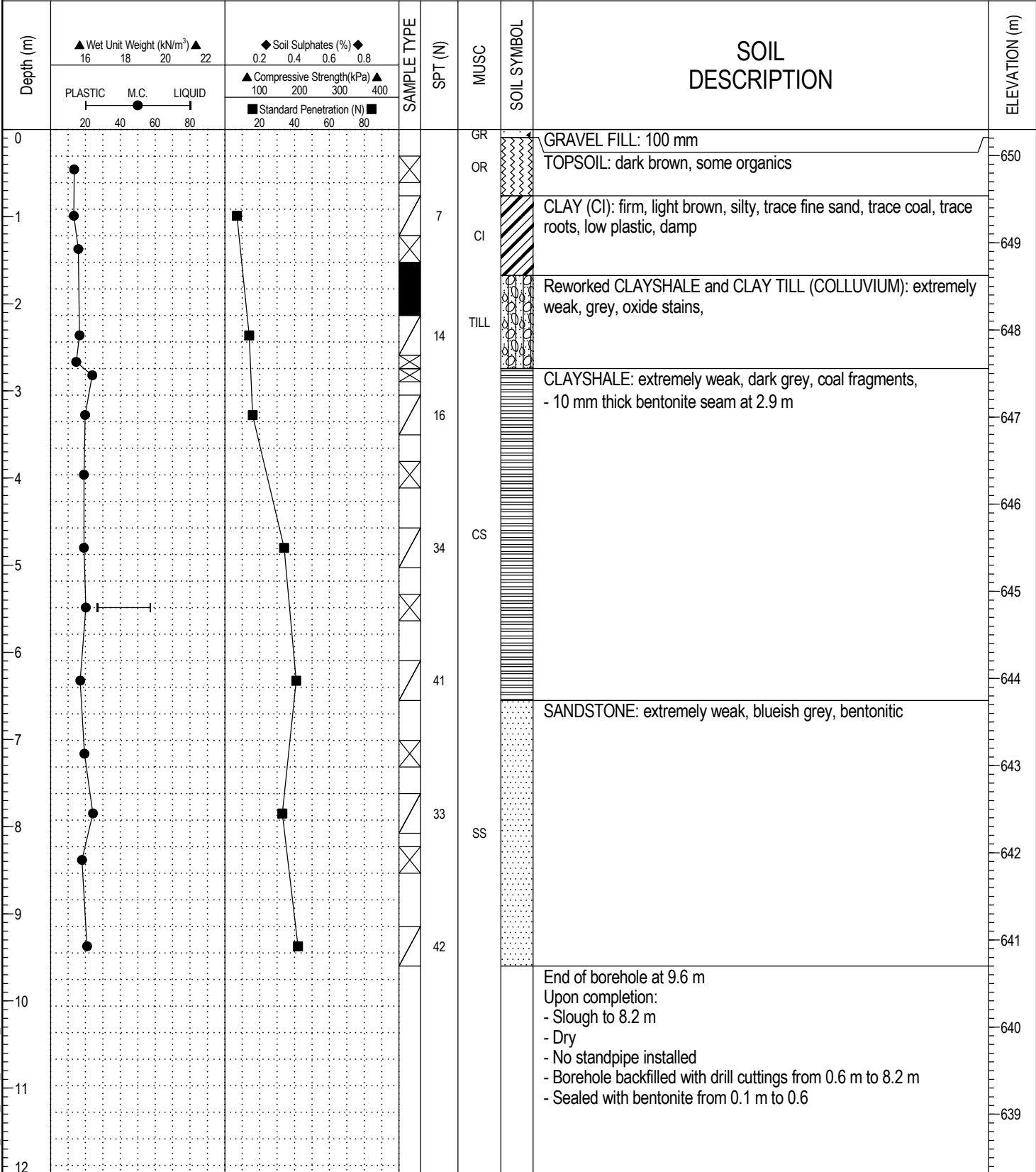

STANDPIP_LOGS_GINT_MILL_CREEK_20170802.GPJ EDMONTON.GDT 12/18/17



LOGGED BY: Craig Unterschultz	COMPLETION DEPTH: 9.60 m
REVIEWED BY: Carrie Murray	COMPLETION DATE: 8/1/17
	Page 1 of 1

PROJECT: Mill Creek Ravine Trail	DRILLING CONTRACTOR: All Service Drilling	BOREHOLE NO: BH17-02
CLIENT: City of Edmonton	UTM GRID: - N5932808 E336028 (± 5 m)	PROJECT NO: 1161106255
START DATE: 8/1/17	12 U	ELEVATION: 652.3 m Geodetic

SAMPLE TYPE	<input checked="" type="checkbox"/> Shelby Tube	<input type="checkbox"/> Drive Sample	<input type="checkbox"/> Auger Sample	<input type="checkbox"/> No Recovery	<input type="checkbox"/> A Casing	<input type="checkbox"/> Cored Sample
BACKFILL TYPE	<input checked="" type="checkbox"/> BENTONITE	<input type="checkbox"/> PEA GRAVEL	<input type="checkbox"/> SLOUGH	<input type="checkbox"/> GROUT	<input type="checkbox"/> DRILL CUTTINGS	<input type="checkbox"/> SAND

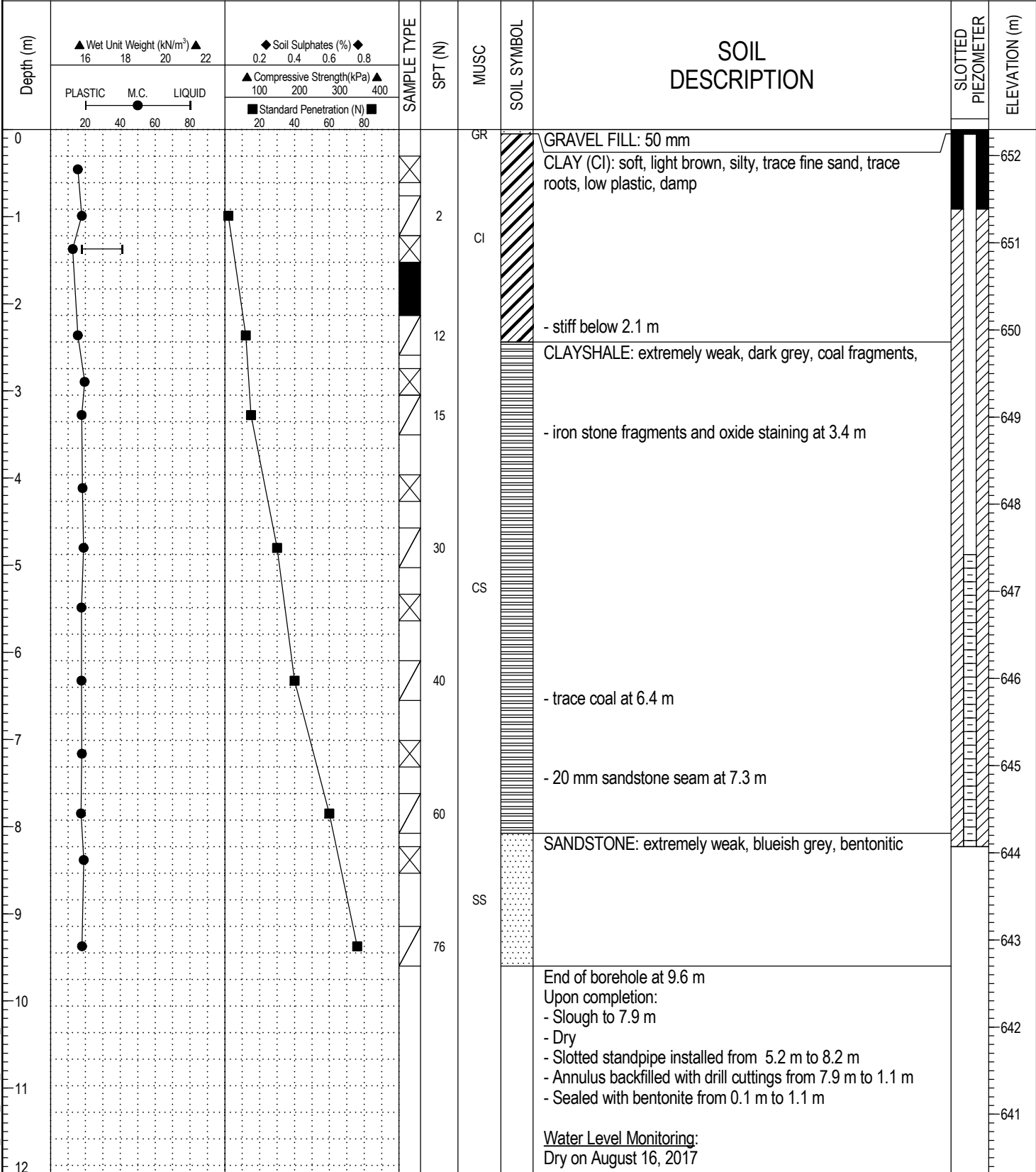

STANDPIP_LOGS_GINT_MILL_CREEK_20170802.GPJ_EDMONTON.GDT_12/18/17



LOGGED BY: Craig Unterschultz	COMPLETION DEPTH: 9.60 m
REVIEWED BY: Carrie Murray	COMPLETION DATE: 8/1/17
Page 1 of 1	

PROJECT: Mill Creek Ravine Trail	DRILLING CONTRACTOR: All Service Drilling	BOREHOLE NO: BH17-03
CLIENT: City of Edmonton	UTM GRID: - N5932213 E336080 (± 5 m)	PROJECT NO: 1161106255
START DATE: 8/1/17	12 U	ELEVATION: 650.3 m Geodetic

SAMPLE TYPE	<input checked="" type="checkbox"/> Shelby Tube	<input type="checkbox"/> Drive Sample	<input checked="" type="checkbox"/> Auger Sample	<input type="checkbox"/> No Recovery	<input type="checkbox"/> A Casing	<input type="checkbox"/> Cored Sample
BACKFILL TYPE	<input checked="" type="checkbox"/> BENTONITE	<input type="checkbox"/> PEA GRAVEL	<input type="checkbox"/> SLOUGH	<input type="checkbox"/> GROUT	<input checked="" type="checkbox"/> DRILL CUTTINGS	<input type="checkbox"/> SAND

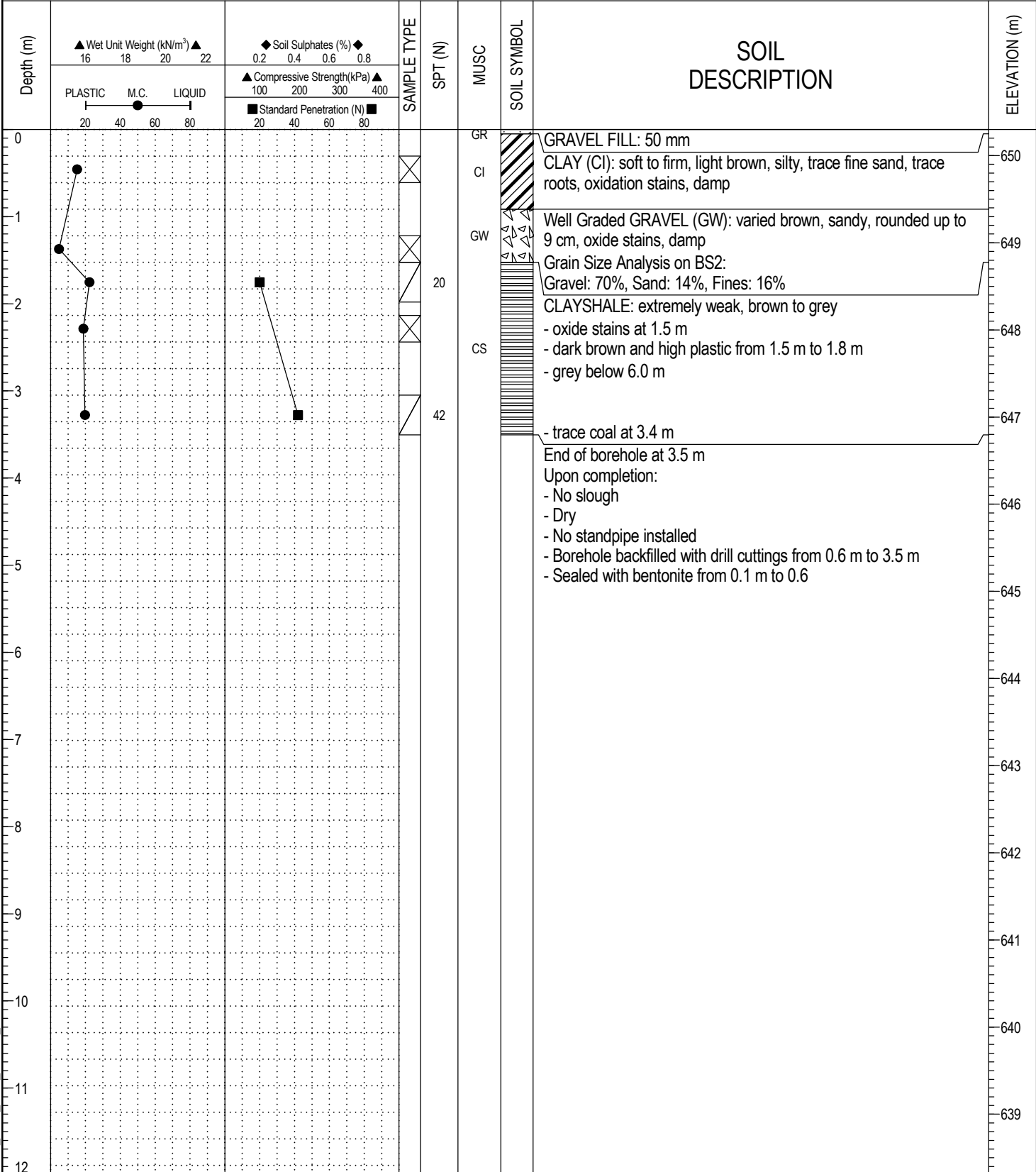

STANDPIP LOGS_GINT_MILL_CREEK_20170802.GPJ EDMONTON.GDT 12/18/17



LOGGED BY: Craig Unterschultz	COMPLETION DEPTH: 3.50 m
REVIEWED BY: Carrie Murray	COMPLETION DATE: 8/1/17
Page 1 of 1	

PROJECT: Mill Creek Ravine Trail	DRILLING CONTRACTOR: All Service Drilling	BOREHOLE NO: BH17-04				
CLIENT: City of Edmonton	UTM GRID: - N5932202 E336087 (± 5 m)	PROJECT NO: 1161106255				
START DATE: 8/1/17	12 U	ELEVATION: 649.2 m Geodetic				
SAMPLE TYPE	<input checked="" type="checkbox"/> Shelby Tube	<input type="checkbox"/> Drive Sample	<input checked="" type="checkbox"/> Auger Sample	<input type="checkbox"/> No Recovery	<input type="checkbox"/> A Casing	<input type="checkbox"/> Cored Sample
BACKFILL TYPE	<input checked="" type="checkbox"/> BENTONITE	<input type="checkbox"/> PEA GRAVEL	<input type="checkbox"/> SLOUGH	<input type="checkbox"/> GROUT	<input checked="" type="checkbox"/> DRILL CUTTINGS	<input type="checkbox"/> SAND

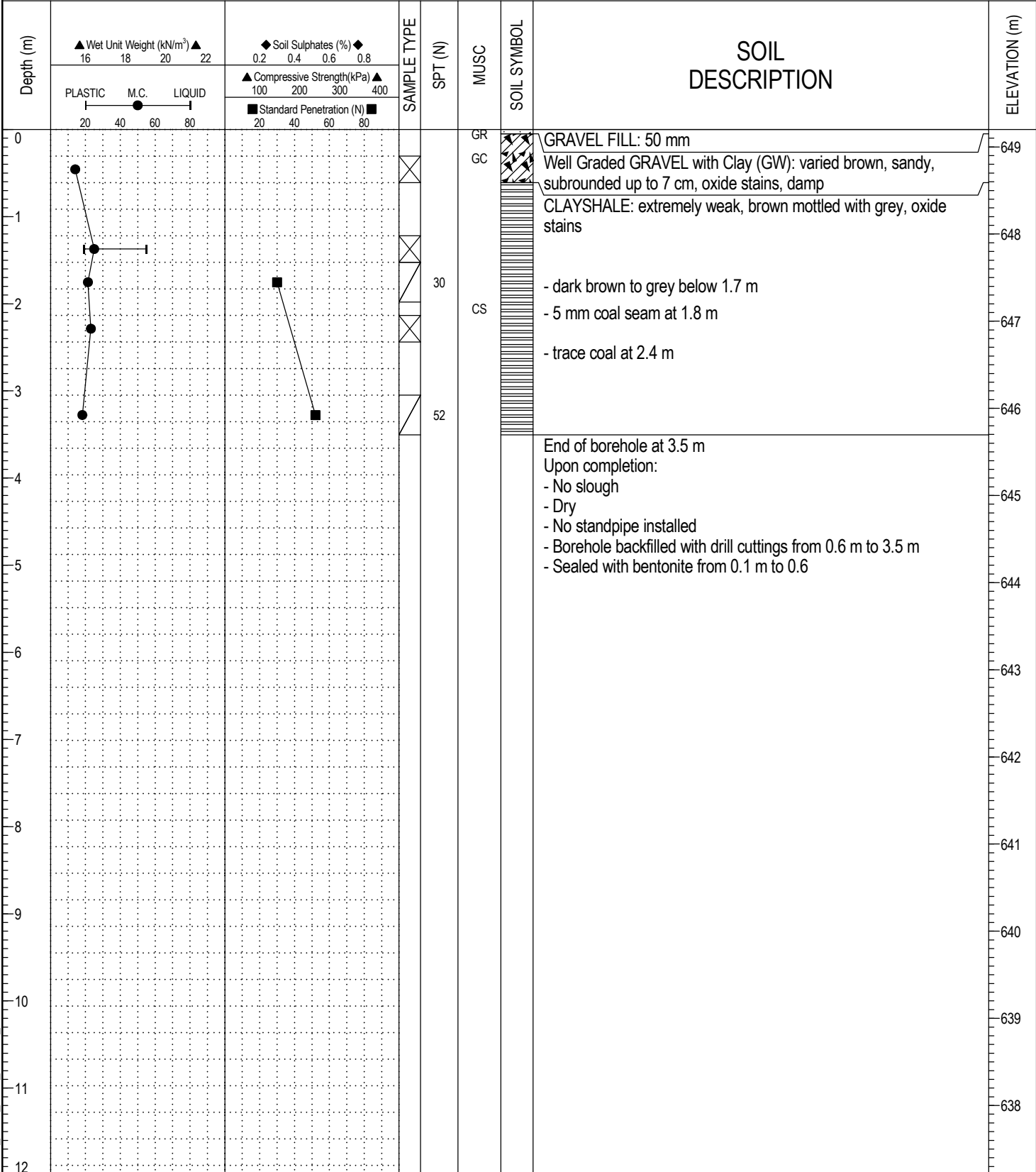

STANDPIP LOGS_GINT_MILL_CREEK_20170802.GPJ EDMONTON.GDT 12/18/17



LOGGED BY: Craig Unterschultz	COMPLETION DEPTH: 3.50 m
REVIEWED BY: Carrie Murray	COMPLETION DATE: 8/1/17
Page 1 of 1	

PROJECT: Mill Creek Ravine Trail	DRILLING CONTRACTOR: Hand Auger	BOREHOLE NO: HA17-01				
CLIENT: City of Edmonton	UTM GRID: - N5933630 E335845 (± 5 m)	PROJECT NO: 1161106255				
START DATE: 8/1/17	12 U	ELEVATION: 635.3 m Geodetic				
SAMPLE TYPE	<input checked="" type="checkbox"/> Shelby Tube	<input type="checkbox"/> Drive Sample	<input checked="" type="checkbox"/> Auger Sample	<input type="checkbox"/> No Recovery	<input type="checkbox"/> A Casing	<input type="checkbox"/> Cored Sample
BACKFILL TYPE	<input checked="" type="checkbox"/> BENTONITE	<input type="checkbox"/> PEA GRAVEL	<input type="checkbox"/> SLOUGH	<input type="checkbox"/> GROUT	<input checked="" type="checkbox"/> DRILL CUTTINGS	<input type="checkbox"/> SAND

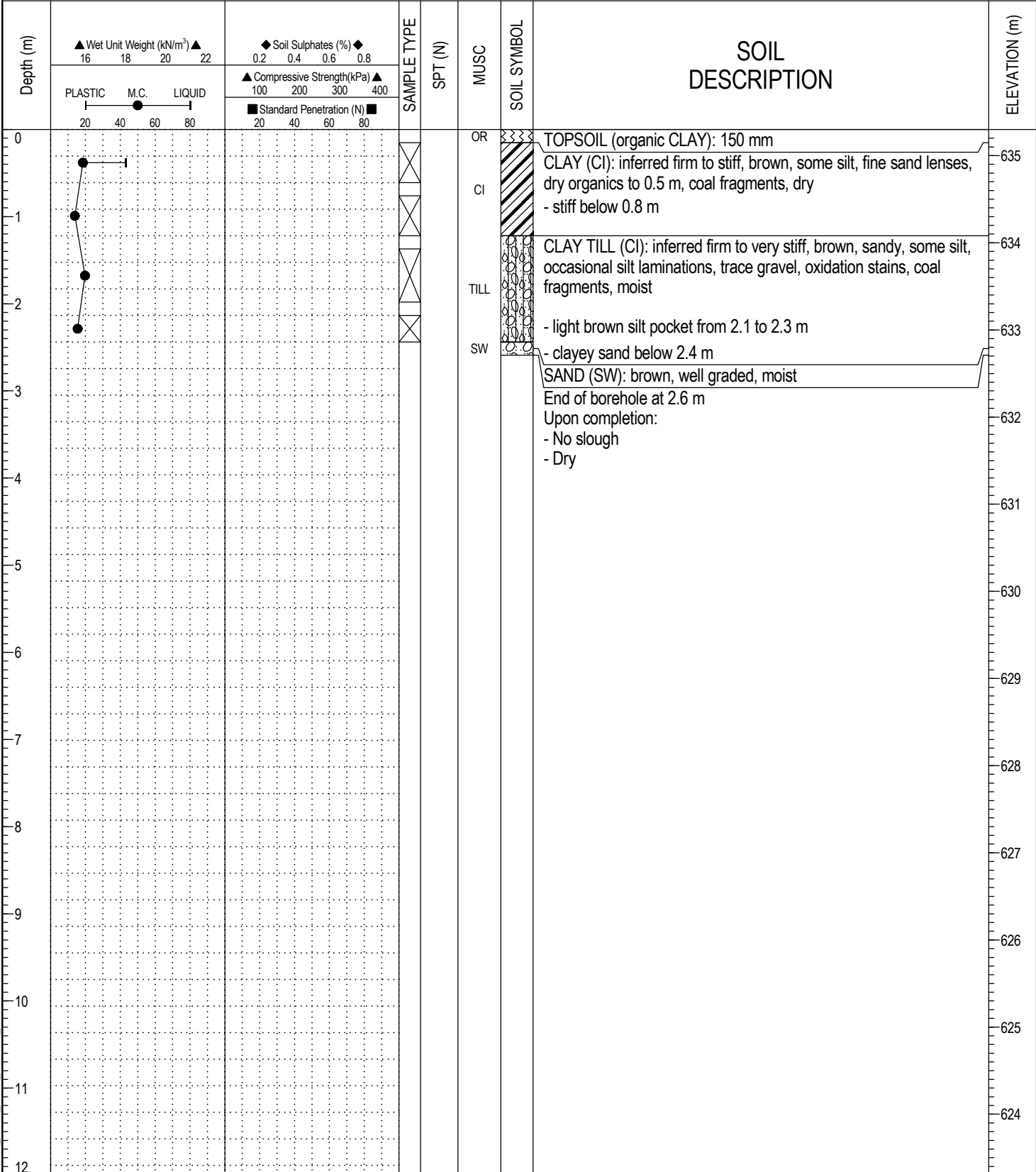

STANDPIP LOGS_GINT_MILL_CREEK_20170802.GPJ EDMONTON.GDT 12/18/17



LOGGED BY: Eric Leishman	COMPLETION DEPTH: 2.40 m
REVIEWED BY: Carrie Murray	COMPLETION DATE: 8/1/17
	Page 1 of 1

PROJECT: Mill Creek Ravine Trail	DRILLING CONTRACTOR: Hand Auger	BOREHOLE NO: HA17-02				
CLIENT: City of Edmonton	UTM GRID: - N5933665 E335842 (± 5 m)	PROJECT NO: 1161106255				
START DATE: 8/1/17	12 U	ELEVATION: 636 m Geodetic				
SAMPLE TYPE	<input checked="" type="checkbox"/> Shelby Tube	<input type="checkbox"/> Drive Sample	<input checked="" type="checkbox"/> Auger Sample	<input type="checkbox"/> No Recovery	<input type="checkbox"/> A Casing	<input type="checkbox"/> Cored Sample
BACKFILL TYPE	<input checked="" type="checkbox"/> BENTONITE	<input type="checkbox"/> PEA GRAVEL	<input type="checkbox"/> SLOUGH	<input type="checkbox"/> GROUT	<input checked="" type="checkbox"/> DRILL CUTTINGS	<input type="checkbox"/> SAND

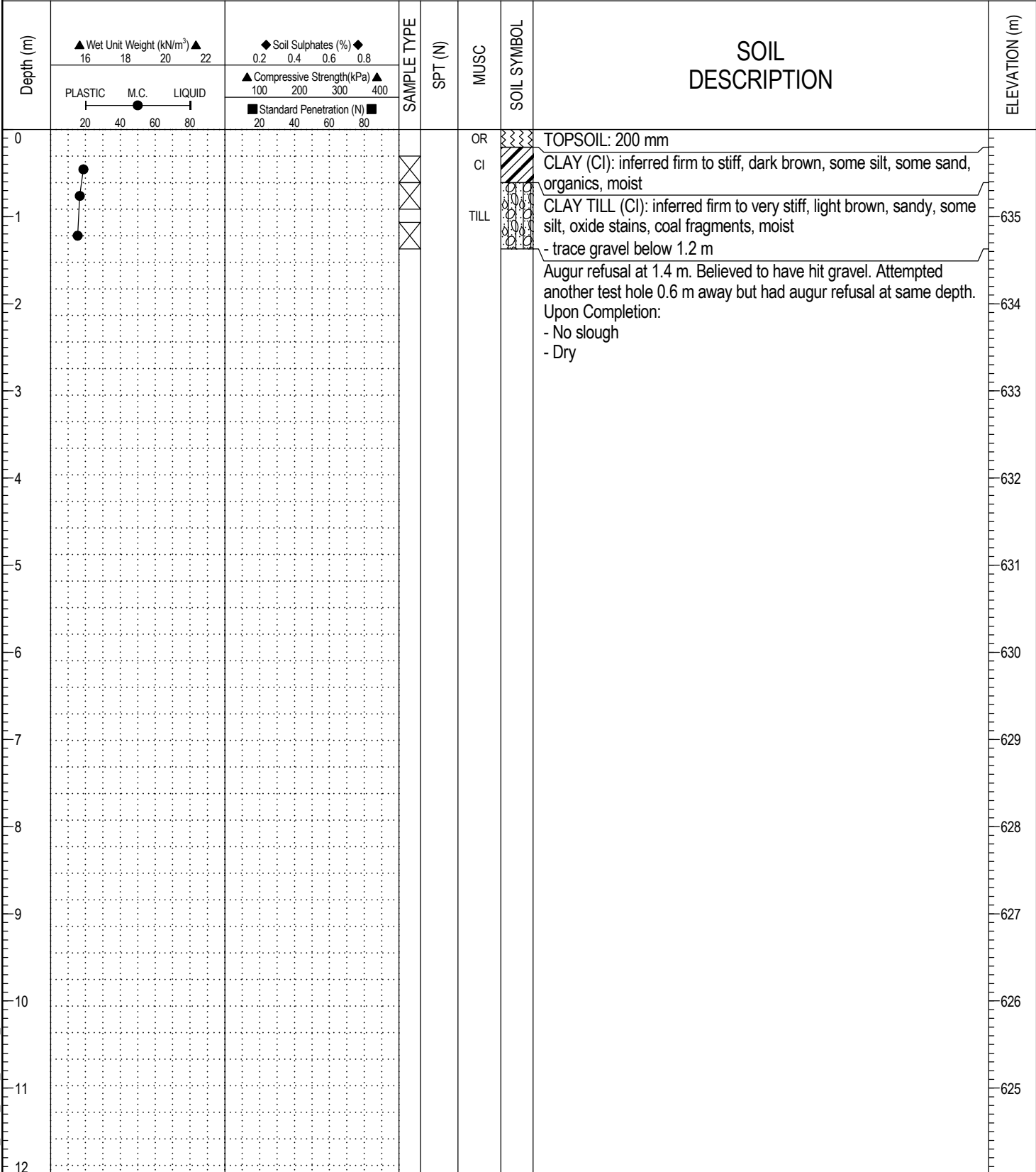

STANDPIP LOGS_GINT_MILL_CREEK_20170802.GPJ EDMONTON.GDT 12/18/17



LOGGED BY: Eric Leishman	COMPLETION DEPTH: 1.40 m
REVIEWED BY: Carrie Murray	COMPLETION DATE: 8/1/17
Page 1 of 1	

PROJECT: Mill Creek Ravine Trail	DRILLING CONTRACTOR: Hand Auger	BOREHOLE NO: HA17-03				
CLIENT: City of Edmonton	UTM GRID: - N5933674 E335811 (± 5 m)	PROJECT NO: 1161106255				
START DATE: 8/1/17	12 U	ELEVATION: 631.3 m Geodetic				
SAMPLE TYPE	<input checked="" type="checkbox"/> Shelby Tube	<input type="checkbox"/> Drive Sample	<input checked="" type="checkbox"/> Auger Sample	<input type="checkbox"/> No Recovery	<input type="checkbox"/> A Casing	<input type="checkbox"/> Cored Sample
BACKFILL TYPE	<input checked="" type="checkbox"/> BENTONITE	<input type="checkbox"/> PEA GRAVEL	<input type="checkbox"/> SLOUGH	<input type="checkbox"/> GROUT	<input checked="" type="checkbox"/> DRILL CUTTINGS	<input type="checkbox"/> SAND

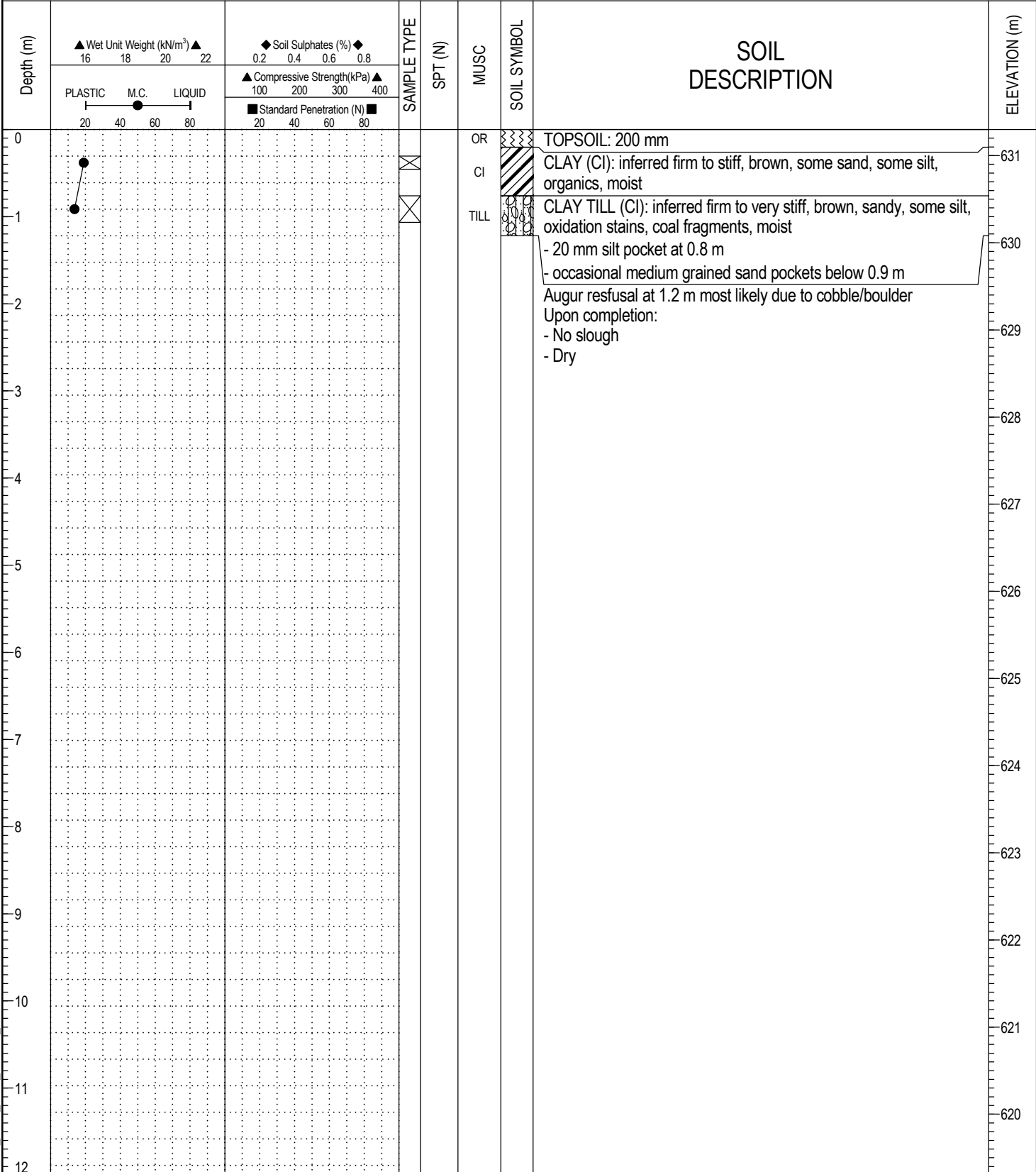

STANDPIP LOGS_GINT_MILL_CREEK_20170802.GPJ EDMONTON.GDT 12/18/17



LOGGED BY: Eric Leishman	COMPLETION DEPTH: 1.20 m
REVIEWED BY: Carrie Murray	COMPLETION DATE: 8/1/17
	Page 1 of 1

Appendix F
LABORATORY TEST RESULTS



Moisture Content of Soil or
Aggregate
CSA A23.2-11A
ASTM D2216

OFFICE
10160 - 112 ST
Edmonton, Alberta
Canada T5K 2L6

LABORATORY
10575 106 ST
Edmonton, Alberta
Canada T5H 2X5

Tel: (780) 917-7000

Tel: (780) 917-7463

Client: City of Edmonton Date Tested: 9-Jul-05
 Project: NRFP Millcreek Ravine Park Tested By: JA
 Project No.: 1161106255

Moisture Content Worksheet							
Borehole / Test Pit No.	BH17-01	BH17-01	BH17-01	BH17-01	BH17-01	BH17-01	BH17-01
Sample	BS1	SS2	BS3	SS5	BS6	BS6A	SS7
Tare No.	WO	EI	21A	222	13	CM	10A
Mass Tare Container	9.3	8.6	9.1	8.7	8.9	8.7	9.6
Mass Sample (Wet+Tare) (g)	160.2	165.2	171.3	164.6	177	165	169.3
Mass Sample (Dry+Tare) (g)	142.3	146.8	149	142.4	155.4	134.8	142.9
Mass of Water (g)	17.90	18.40	22.30	22.20	21.60	30.20	26.40
Mass Dry Sample (g)	133.00	138.20	139.90	133.70	146.50	126.10	133.30
Moisture Content (%)	13.5%	13.3%	15.9%	16.6%	14.7%	23.9%	19.8%
Comments							
Borehole / Test Pit No.	BH17-01	BH17-01	BH17-01	BH17-01	BH17-01	BH17-01	BH17-01
Sample	BS8	SS9	BS10	SS11	BS12	SS13	BS14
Tare No.	EE	7A	D1	38	7	S7	CY
Mass Tare Container	8.8	9.4	8.8	9.3	8.7	8.6	8.6
Mass Sample (Wet+Tare) (g)	188	167.5	181.2	177.5	176.6	180.9	183.3
Mass Sample (Dry+Tare) (g)	159.2	142.2	152.2	153.1	149.3	147.2	156.7
Mass of Water (g)	28.80	25.30	29.00	24.40	27.30	33.70	26.60
Mass Dry Sample (g)	150.40	132.80	143.40	143.80	140.60	138.60	148.10
Moisture Content (%)	19.1%	19.1%	20.2%	17.0%	19.4%	24.3%	18.0%
Comments							
Borehole / Test Pit No.	BH17-01	HA17-01	HA17-01	HA17-01	HA17-01	HA17-02	HA17-02
Sample	SS15	BS1	BS2	BS3	BS4	BS1	BS2
Tare No.	17A	7A	35A	7	SS1	CY	17A
Mass Tare Container	9.4	9.3	9.3	8.7	8.7	8.6	9.5
Mass Sample (Wet+Tare) (g)	183.2	88.1	116.1	163.5	128.9	113.3	136.5
Mass Sample (Dry+Tare) (g)	153.1	75.8	103.1	138	112.8	96.7	118.3
Mass of Water (g)	30.10	12.30	13.00	25.50	16.10	16.60	18.20
Mass Dry Sample (g)	143.70	66.50	93.80	129.30	104.10	88.10	108.80
Moisture Content (%)	20.9%	18.5%	13.9%	19.7%	15.5%	18.8%	16.7%
Comments							
Borehole / Test Pit No.	HA17-02	HA17-03	HA17-03				
Sample	BS3	BS1	BS2				
Tare No.	ED	RJ	DS				
Mass Tare Container	8.9	8.6	8.5				
Mass Sample (Wet+Tare) (g)	134.6	103.1	101.5				
Mass Sample (Dry+Tare) (g)	117.7	88	90.3				
Mass of Water (g)	16.90	15.10	11.20				
Mass Dry Sample (g)	108.80	79.40	81.80				
Moisture Content (%)	15.5%	19.0%	13.7%				
Comments							

Reviewed By: _____

Reporting of these test results constitutes a testing service only. Engineering interpretation or evaluation of the test results is provided only on written request. The data presented above is for the sole use of the client stipulated above. Stantec is not responsible, nor can be held liable, for the use of this report by any other party, with or without the knowledge of Stantec.



Moisture Content of Soil or
Aggregate
CSA A23.2-11A
ASTM D2216

OFFICE
10160 - 112 ST
Edmonton, Alberta
Canada T5K 2L6

LABORATORY
10575 106 ST
Edmonton, Alberta
Canada T5H 2X5

Tel: (780) 917-7000

Tel: (780) 917-7463

Client: City of Edmonton Date Tested: 10-Aug-17
 Project: NRFP Millcreek Ravine Park Tested By: JA
 Project No.: 1161106255

Moisture Content Worksheet							
Borehole / Test Pit No.	HA	BH17-02	BH17-02	BH17-02	BH17-02	BH17-02	BH17-02
Sample	BS1	SS2	BS3	SS5	BS6	SS7	BS8
Tare No.	ED	RJ	D5	D19	D22	IGGY	D9
Mass Tare Container	8.9	8.7	8.5	8.5	8.6	8.5	8.4
Mass Sample (Wet+Tare) (g)	204.5	163.8	175.9	162.3	166.6	170.1	174.7
Mass Sample (Dry+Tare) (g)	178.1	140.3	157	141.6	140.8	145.7	149
Mass of Water (g)	26.40	23.50	18.90	20.70	25.80	24.40	25.70
Mass Dry Sample (g)	169.20	131.60	148.50	133.10	132.20	137.20	140.60
Moisture Content (%)	15.6%	17.9%	12.7%	15.6%	19.5%	17.8%	18.3%
Comments							
Borehole / Test Pit No.	BH17-02	BH17-02	BH17-02	BH17-02	BH17-02	BH17-02	BH17-02
Sample	SS9	BS10	SS11	BS12	SS13	BS14	SS15
Tare No.	29	ZZ3	DZ	C4	50	27A	109
Mass Tare Container	9.4	8.4	8.5	9.9	8.8	9.3	9.3
Mass Sample (Wet+Tare) (g)	166.4	188.6	173.5	182.6	160.9	85.2	156.2
Mass Sample (Dry+Tare) (g)	141.4	161.5	148.7	156.4	138.4	73.1	133.8
Mass of Water (g)	25.00	27.10	24.80	26.20	22.50	12.10	22.40
Mass Dry Sample (g)	132.00	153.10	140.20	146.50	129.60	63.80	124.50
Moisture Content (%)	18.9%	17.7%	17.7%	17.9%	17.4%	19.0%	18.0%
Comments							
Borehole / Test Pit No.	BH17-03	BH17-03	BH17-03	BH17-03	BH17-03	BH17-04	BH17-04
Sample	BS1	BS2	SS3	BS4	SS5	BS1	BS2
Tare No.	14	A12	25A	WD	EI	21A	222
Mass Tare Container	8.6	230.3	9.6	8.4	8.6	9.1	8.7
Mass Sample (Wet+Tare) (g)	190.1	1941.2	144.6	178.7	121.1	167.6	233.6
Mass Sample (Dry+Tare) (g)	166.1	1862.3	120	151.8	102.6	148	188.6
Mass of Water (g)	24.00	78.90	24.60	26.90	18.50	19.60	45.00
Mass Dry Sample (g)	157.50	1632.00	110.40	143.40	94.00	138.90	179.90
Moisture Content (%)	15.2%	4.8%	22.3%	18.8%	19.7%	14.1%	25.0%
Comments							
Borehole / Test Pit No.	BH17-04	BH17-04	BH17-04				
Sample	SS3	BS4	SS5				
Tare No.	CM	10A	EE				
Mass Tare Container	8.7	9.5	8.7				
Mass Sample (Wet+Tare) (g)	107.5	125.6	177.3				
Mass Sample (Dry+Tare) (g)	90.1	103.8	151.3				
Mass of Water (g)	17.40	21.80	26.00				
Mass Dry Sample (g)	81.40	94.30	142.60				
Moisture Content (%)	21.4%	23.1%	18.2%				
Comments							

Reviewed By: 

Reporting of these test results constitutes a testing service only. Engineering interpretation or evaluation of the test results is provided only on written request. The data presented above is for the sole use of the client stipulated above. Stantec is not responsible, nor can be held liable, for the use of this report by any other party, with or without the knowledge of Stantec.



Atterberg Limits
ASTM D4318
Method B- One Point

Client: City of Edmonton
Project Name: NRFP Millcreek Ravine Park
Project No: 1161106255
Date Received: August 1, 2017
Date Tested: August 14, 2017
Tested By: JA

OFFICE
10160 - 112 ST
Edmonton, Alberta
Canada T5K 2L6
Tel: (780) 917-7000

LABORATORY
10575 106 ST
Edmonton, Alberta
Canada T5H 2X5
Tel: (780) 917-7463

Sample: BH17-02 BS3		Sample: BH17-04 BS2	
LIQUID		LIQUID	
1	2	Trial No.	1 2
29	30	Number of Blows	27 29
21B	4B	Container Number	42B 35B
36.17	38.83	Wt. Sample (wet+tare)(g)	36.39 36.26
30.34	32.14	Wt. Sample (dry+tare)(g)	29.08 29.04
15.54	15.50	Wt. Tare (g)	15.61 15.70
14.8	16.6	Wt. Dry Soil (g)	13.5 13.3
5.8	6.7	Wt. Water (g)	7.3 7.2
39.4%	40.2%	Water Content (%)	54.3% 54.1%
40.1%	41.1%	Corrected Water Content (%)	54.8% 55.1%
PLASTIC		PLASTIC	
1	2	Trial No.	1 2
AF	BS	Container Number	BN BV
20.2	20.41	Wt. Sample (wet+tare)(g)	20.41 20.88
19.26	19.38	Wt. Sample (dry+tare)(g)	19.38 19.82
14.07	13.90	Wt. Tare (g)	14.04 14.15
5.2	5.5	Wt. Dry Soil (g)	5.3 5.7
0.9	1.0	Wt. Water (g)	1.0 1.1
18.1%	18.8%	Water Content (%)	19.3% 18.7%
AVERAGE VALUES		AVERAGE VALUES	
1	2	1	2
LL	41	LL	55
PL	18	PL	19
PI	23	PI	36
Natural MC (%)	12.7%	Natural MC (%)	25.0%
CLASSIFICATION		CLASSIFICATION	
CI		CH	

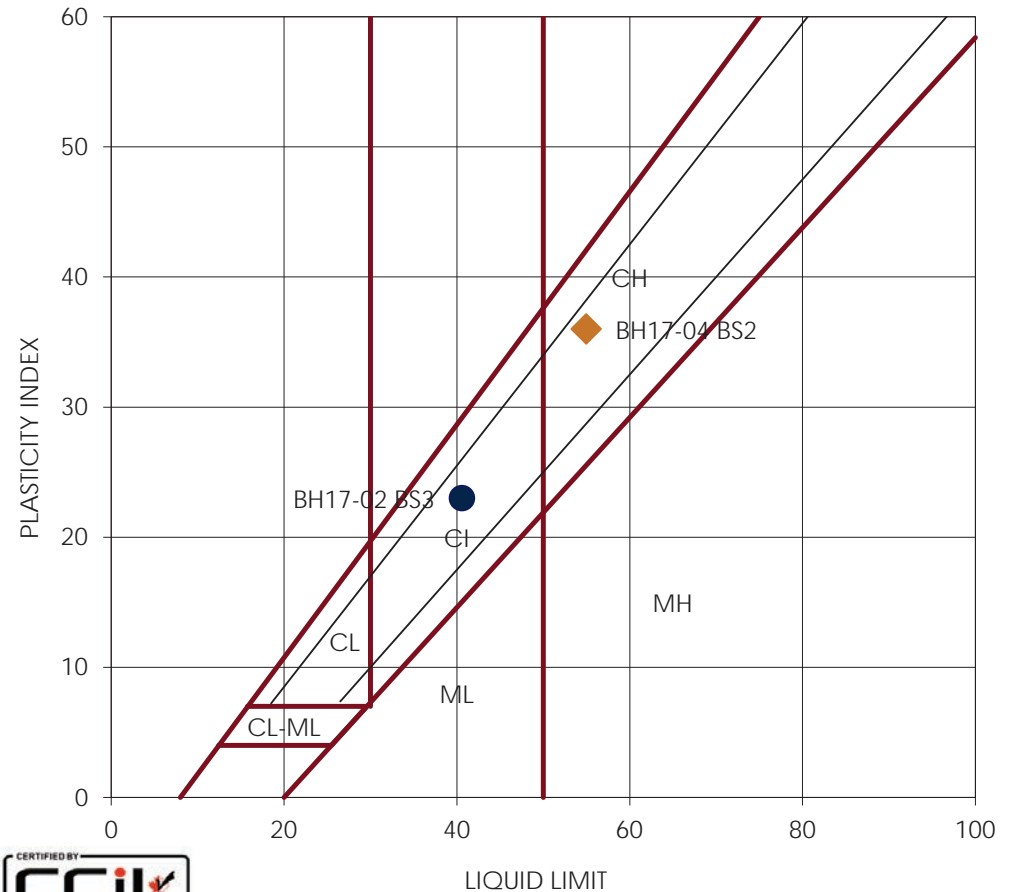

Reporting of these test results constitutes a testing service only. Engineering interpretation or evaluation of the test results is provided only on written request. The data presented above is for the sole use of the client stipulated above. STANTEC is not responsible, nor can be held liable, for the use of this report by any other party, with or without the knowledge of STANTEC.

Reviewed By: _____



Atterberg Limits
ASTM D4318
Method B- One Point

Client: City of Edmonton
Project Name: NRFP Millcreek Ravine Park
Project No: 1161106255
Date Received: August 1, 2017
Date Tested: August 14, 2017
Tested By: JA

OFFICE
10160 - 112 ST
Edmonton, Alberta
Canada T5K 2L6
Tel: (780) 917-7000

LABORATORY
10575 106 ST
Edmonton, Alberta
Canada T5H 2X5
Tel: (780) 917-7463

Sample: HA17-01 BS1		Sample: BH17-01 BS10	
LIQUID		LIQUID	
1	2	Trial No.	
24	25	Number of Blows	30
15B	39B	Container Number	3B
38.01	37.64	Wt. Sample (wet+tare)(g)	37.75
31.25	30.92	Wt. Sample (dry+tare)(g)	29.78
15.58	15.37	Wt. Tare (g)	15.52
15.7	15.6	Wt. Dry Soil (g)	14.3
6.8	6.7	Wt. Water (g)	8.0
43.1%	43.2%	Water Content (%)	55.9%
42.9%	43.2%	Corrected Water Content (%)	57.1%
PLASTIC		PLASTIC	
1	2	Trial No.	
BF	BK	Container Number	BC
20.55	20.47	Wt. Sample (wet+tare)(g)	20.55
19.52	19.36	Wt. Sample (dry+tare)(g)	19.19
14.26	13.84	Wt. Tare (g)	14.19
5.3	5.5	Wt. Dry Soil (g)	5.0
1.0	1.1	Wt. Water (g)	1.4
19.6%	20.1%	Water Content (%)	27.2%
AVERAGE VALUES		AVERAGE VALUES	
1	2	1	2
LL	43	LL	57
PL	20	PL	27
PI	23	PI	30
Natural MC (%)	18.5%	Natural MC (%)	20.2%
CLASSIFICATION		CLASSIFICATION	
CI		CH	

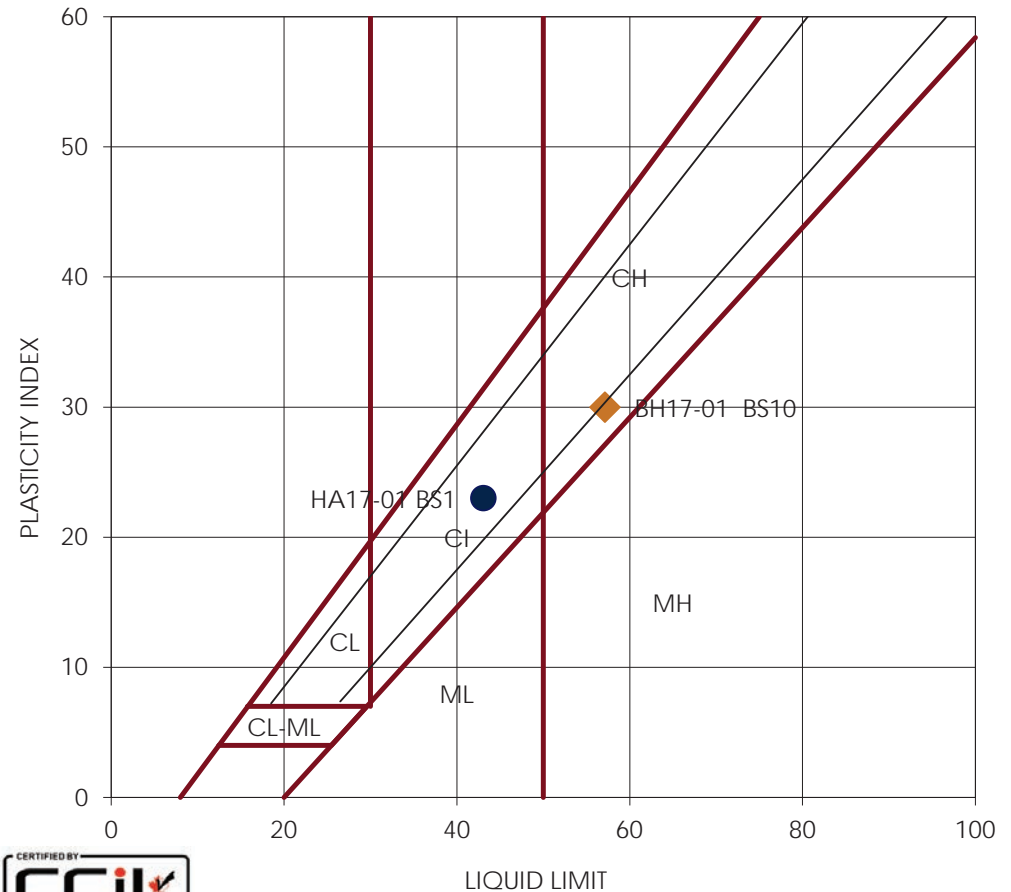

Reporting of these test results constitutes a testing service only. Engineering interpretation or evaluation of the test results is provided only on written request. The data presented above is for the sole use of the client stipulated above. STANTEC is not responsible, nor can be held liable, for the use of this report by any other party, with or without the knowledge of STANTEC.

Reviewed By: 



Grain Size
Analysis
ASTM C136, ASTM C117

Client: City of Edmonton
Project Name: NRFP Millcreek Ravine Park
Project No: 1161106255.400

OFFICE LABORATORY
10160 - 112 ST 10575 106 ST
Edmonton, Alberta Edmonton, Alberta
Canada T5K 2L6 Canada T5H 2X5

Tel: (780) 917-7000 Tel: (780) 917-7463

SAMPLE No.: BS2
SOURCE: BH17-03
TESTED BY: JA

DATE RECEIVED: August 1, 2017
DATE TESTED: August 11, 2017
SAMPLE DESCRIPTION: GRAVEL-SAND-CLAY AND/OR SILT MIXTURES

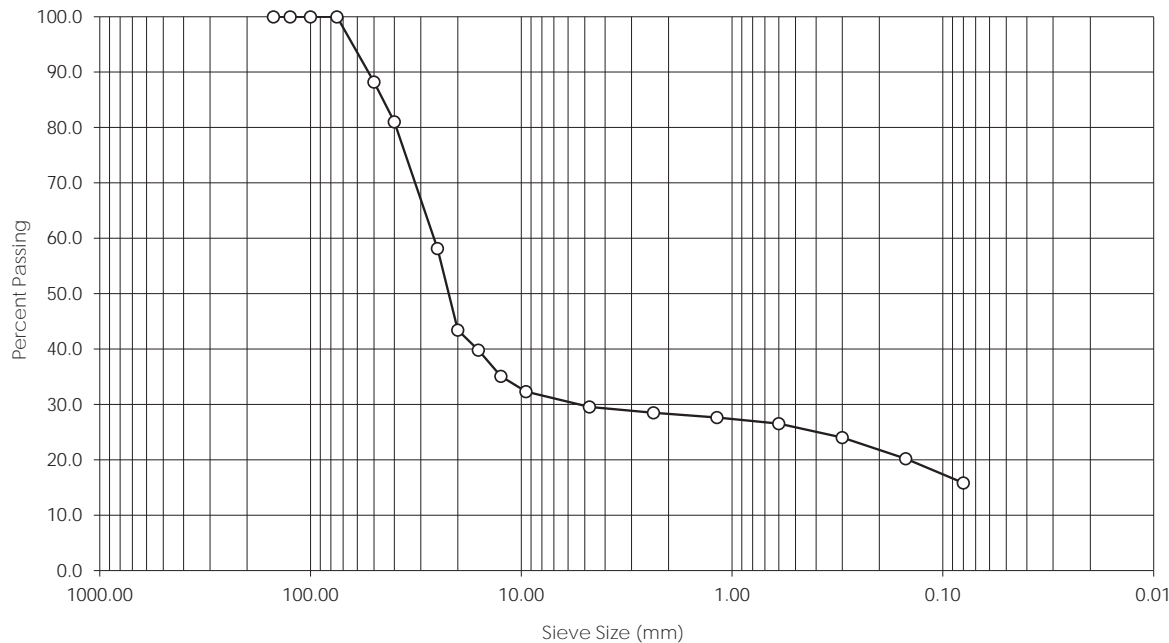

Sieve (mm)	Sample % Passing	Specifications	
		Lower	Upper
150.0	100.0	-	-
125.0	100.0	-	-
100.0	100.0	-	-
75.0	100.0	-	-
50.0	88.2	-	-
40.0	81.0	-	-
25.0	58.1	-	-
20.0	43.4	-	-
16.0	39.8	-	-
12.5	35.1	-	-
9.5	32.3	-	-
4.75	29.5	-	-
2.36	28.5	-	-
1.18	27.7	-	-
0.600	26.5	-	-
0.300	24.0	-	-
0.150	20.2	-	-
0.080	15.8	-	-
Cobble:	0.0%	D ₁₀ :	-
Gravel:	70.5%	D ₃₀ :	5.5881
Sand:	13.7%	D ₆₀ :	26.4159
Fines:	15.8%	C _u :	-
		C _c :	-



—○— % Passing -◇- Upper Limit -▲- Lower Limit

Comments: MUSCS DESCRIPTION

Reviewed by:

Reporting of these test results constitutes a testing service only. Engineering interpretation or evaluation of the test results is provided only on written request. The data presented above is for the sole use of the client stipulated above. Stantec is not responsible, nor can be held liable, for the use of this report by any other party, with or without the knowledge of Stantec.

Appendix G
SLOPE STABILITY ANALYSIS RESULTS







Color	Name	Unit Weight (kN/m ³)	Cohesion' (kPa)	Phi' (°)	Piezometric Line
	Bentonite	18	0	14	
	Clay	19	0	20	1
	Clay Till	20	0	28	1
	Fill	18	0	20	1
	Lower Shale	20	50	25	
	Sandstone	21	20	35	
	Upper Shale	20	0	25	

Figure G.1
Cross-Section A Existing
Geometry Circular
Failure Plane







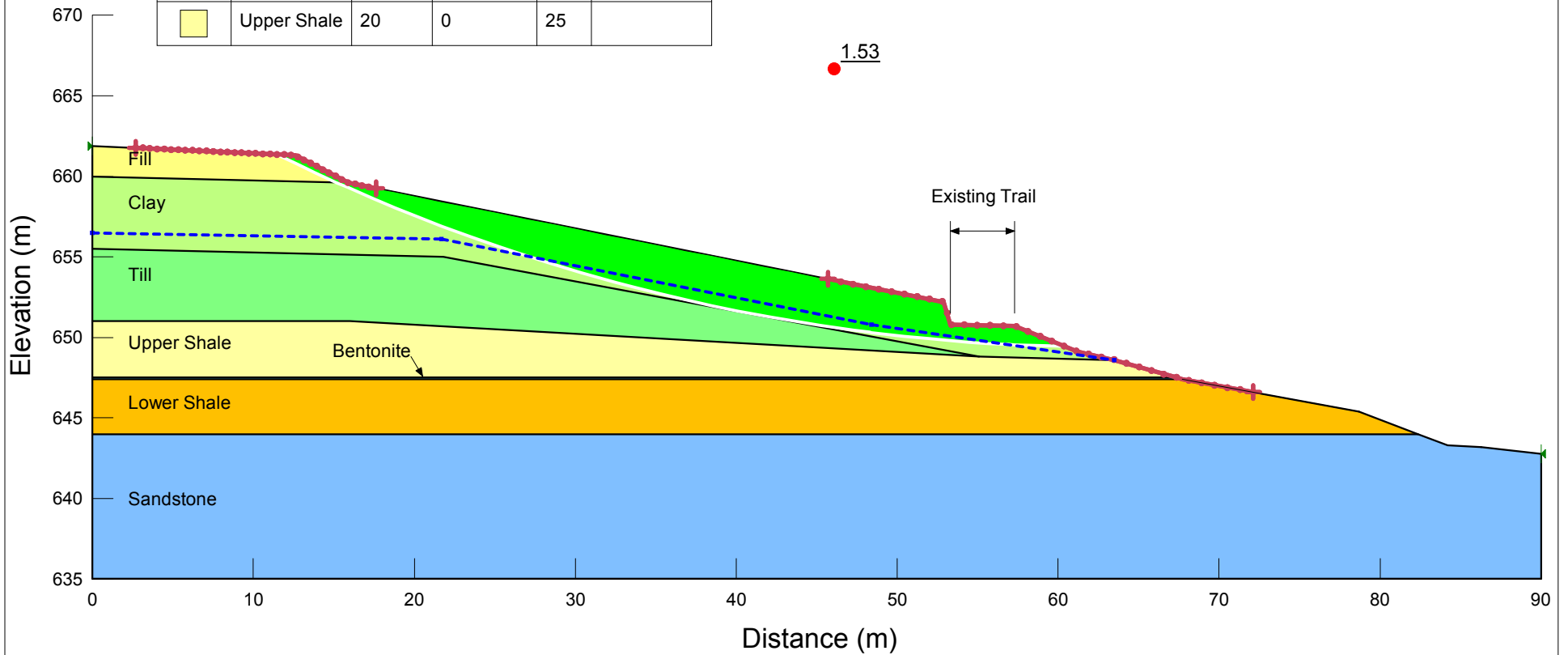

Color	Name	Unit Weight (kN/m ³)	Cohesion' (kPa)	Phi' (°)	Piezometric Line
	Bentonite	18	0	14	
	Clay	19	0	20	1
	Clay Till	20	0	28	1
	Fill	18	0	20	1
	Lower Shale	20	50	25	
	Sandstone	21	20	35	
	Upper Shale	20	0	25	

Figure G.2
 Cross-Section A
 Option 1: Short Radius
 Circular Failure Plane







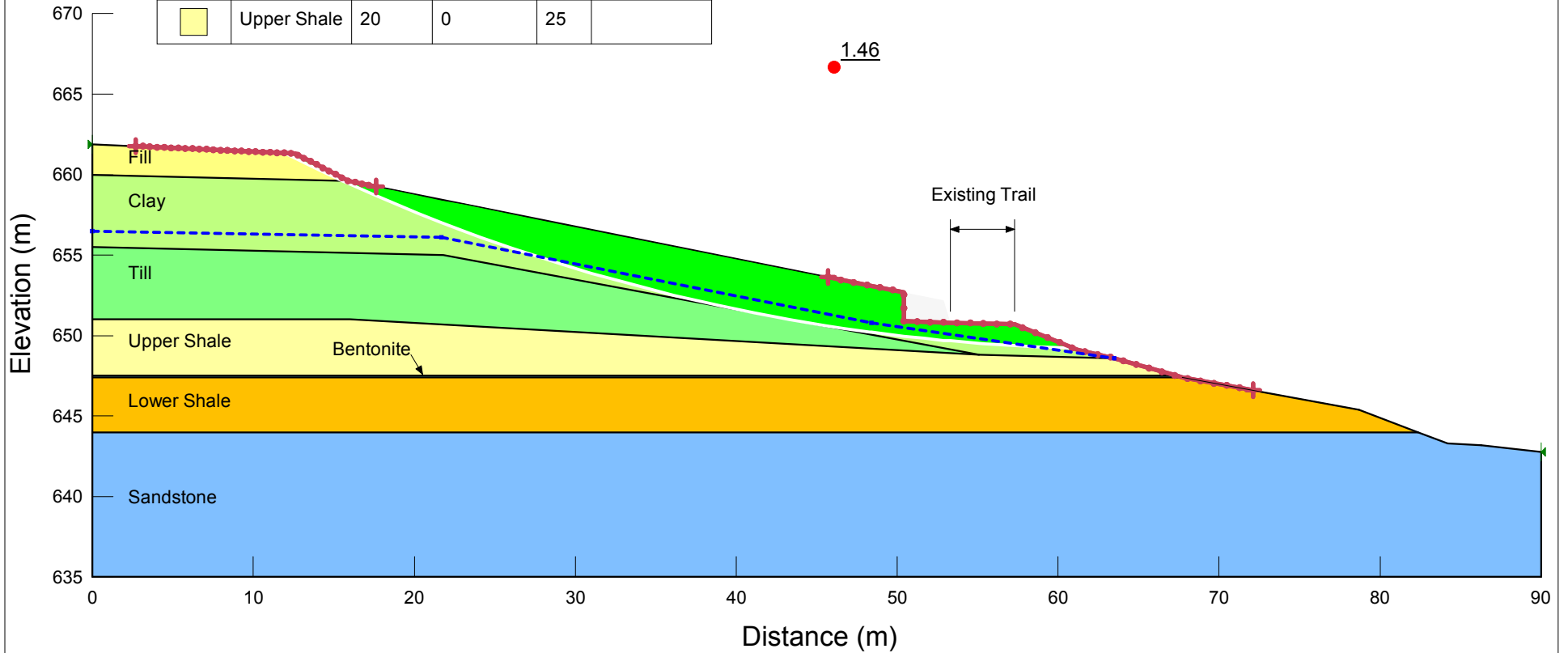

Color	Name	Unit Weight (kN/m ³)	Cohesion' (kPa)	Phi' (°)	Piezometric Line
	Bentonite	18	0	14	
	Clay	19	0	20	1
	Clay Till	20	0	28	1
	Fill	18	0	20	1
	Lower Shale	20	50	25	
	Sandstone	21	20	35	
	Upper Shale	20	0	25	

Figure G.3
 Cross-Section A
 Option 2: Long Radius
 Circular Failure Plane







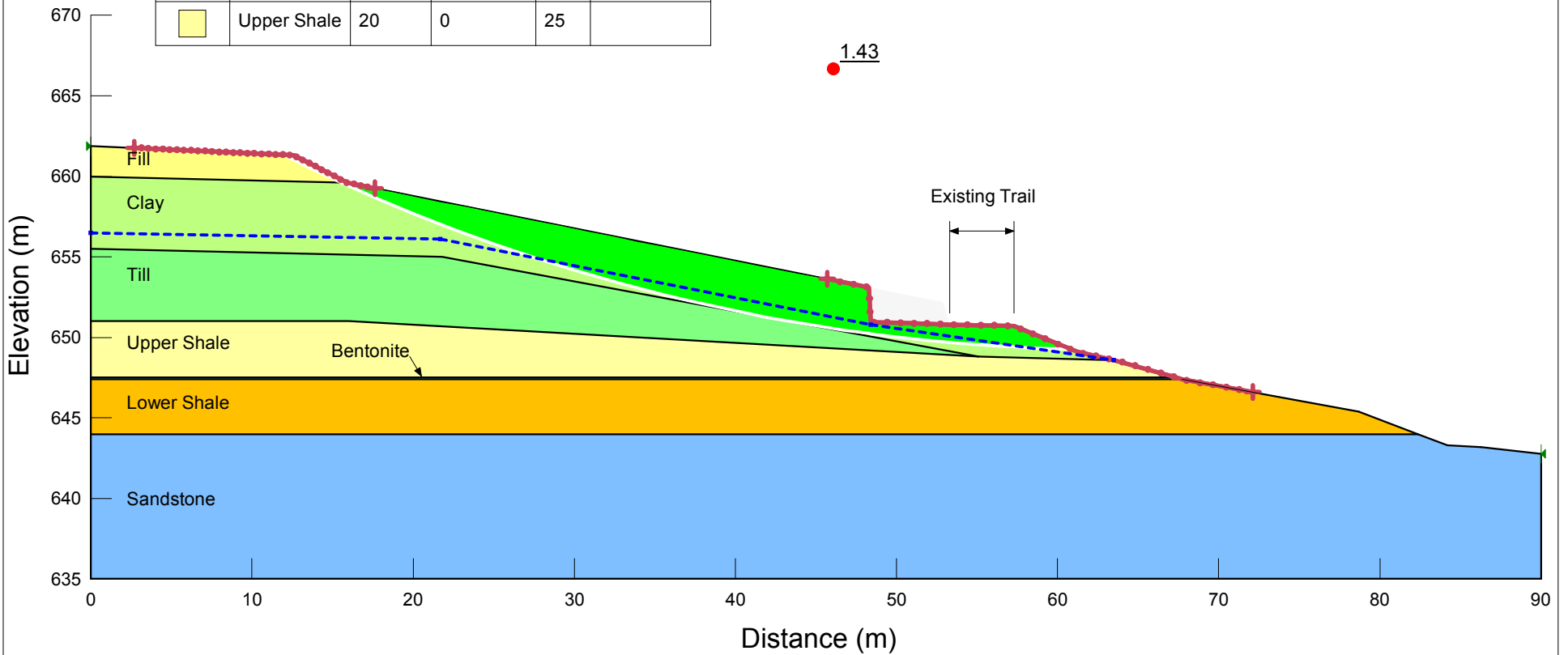

Color	Name	Unit Weight (kN/m ³)	Cohesion' (kPa)	Phi' (°)	Piezometric Line
	Bentonite	18	0	14	
	Clay	19	0	20	1
	Clay Till	20	0	28	1
	Fill	18	0	20	1
	Lower Shale	20	50	25	
	Sandstone	21	20	35	
	Upper Shale	20	0	25	

Figure G.4
Cross-Section A
Existing Geometry
Block Failure Surface







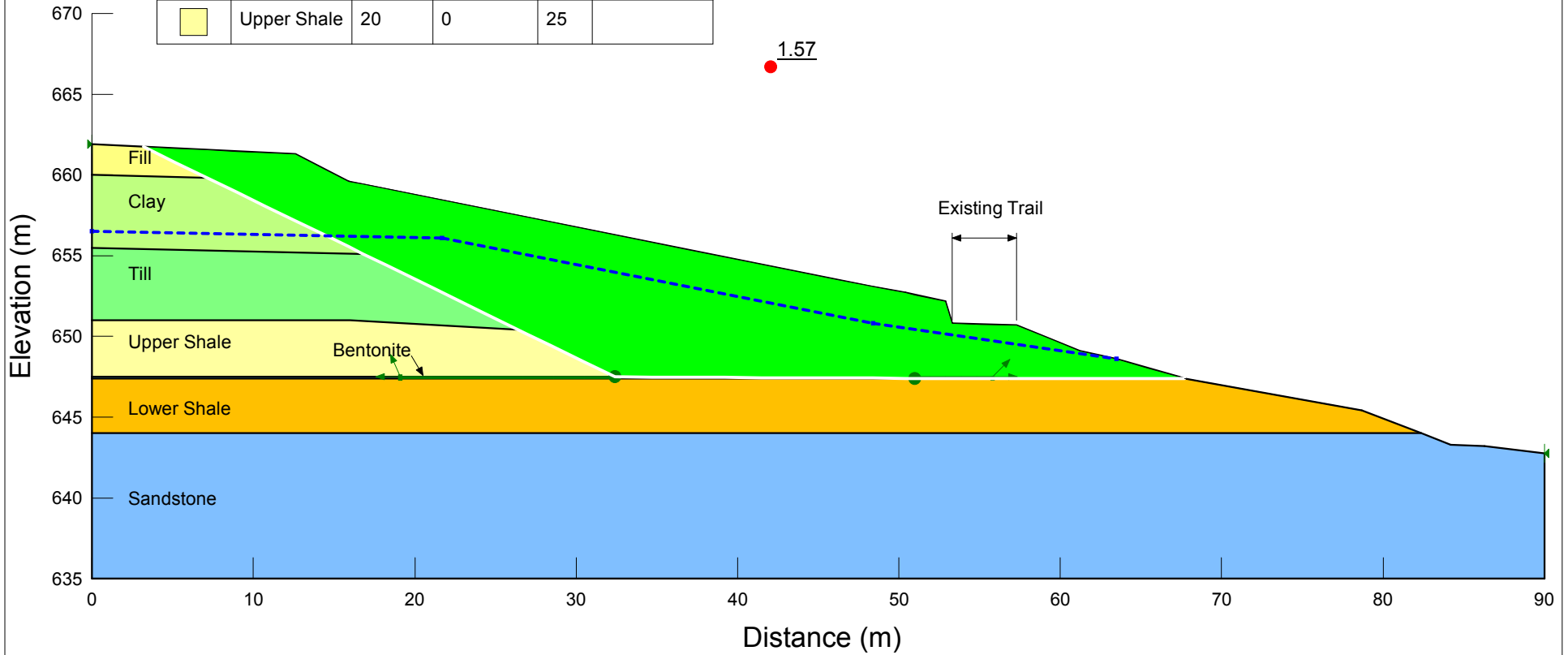

Color	Name	Unit Weight (kN/m ³)	Cohesion' (kPa)	Phi' (°)	Piezometric Line
	Bentonite	18	0	14	
	Clay	19	0	20	1
	Clay Till	20	0	28	1
	Fill	18	0	20	1
	Lower Shale	20	50	25	
	Sandstone	21	20	35	
	Upper Shale	20	0	25	

Figure G.5
Cross-Section A
Option 1: Short Radius
Block Failure Surface







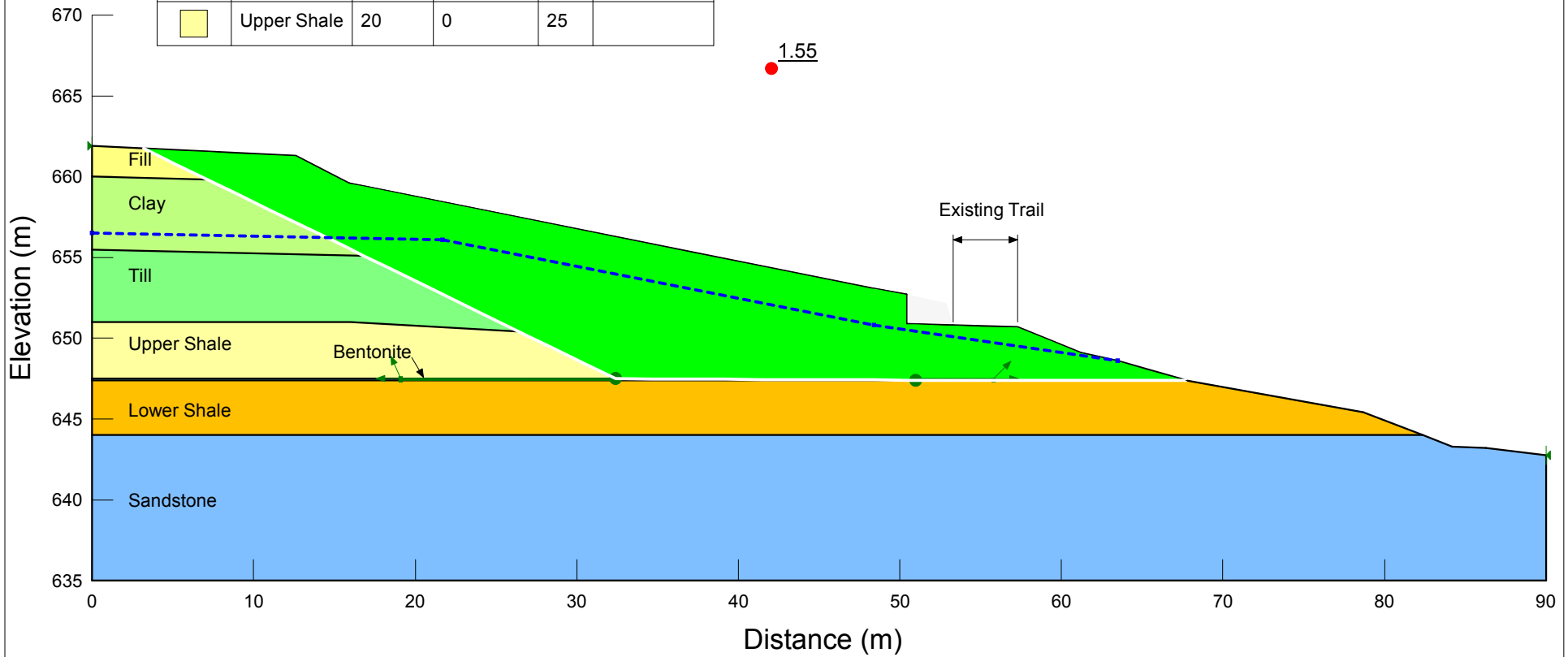

Color	Name	Unit Weight (kN/m ³)	Cohesion' (kPa)	Phi' (°)	Piezometric Line
	Bentonite	18	0	14	
	Clay	19	0	20	1
	Clay Till	20	0	28	1
	Fill	18	0	20	1
	Lower Shale	20	50	25	
	Sandstone	21	20	35	
	Upper Shale	20	0	25	

Figure G.6
 Cross-Section A
 Option 2: Long Radius
 Block Failure Surface





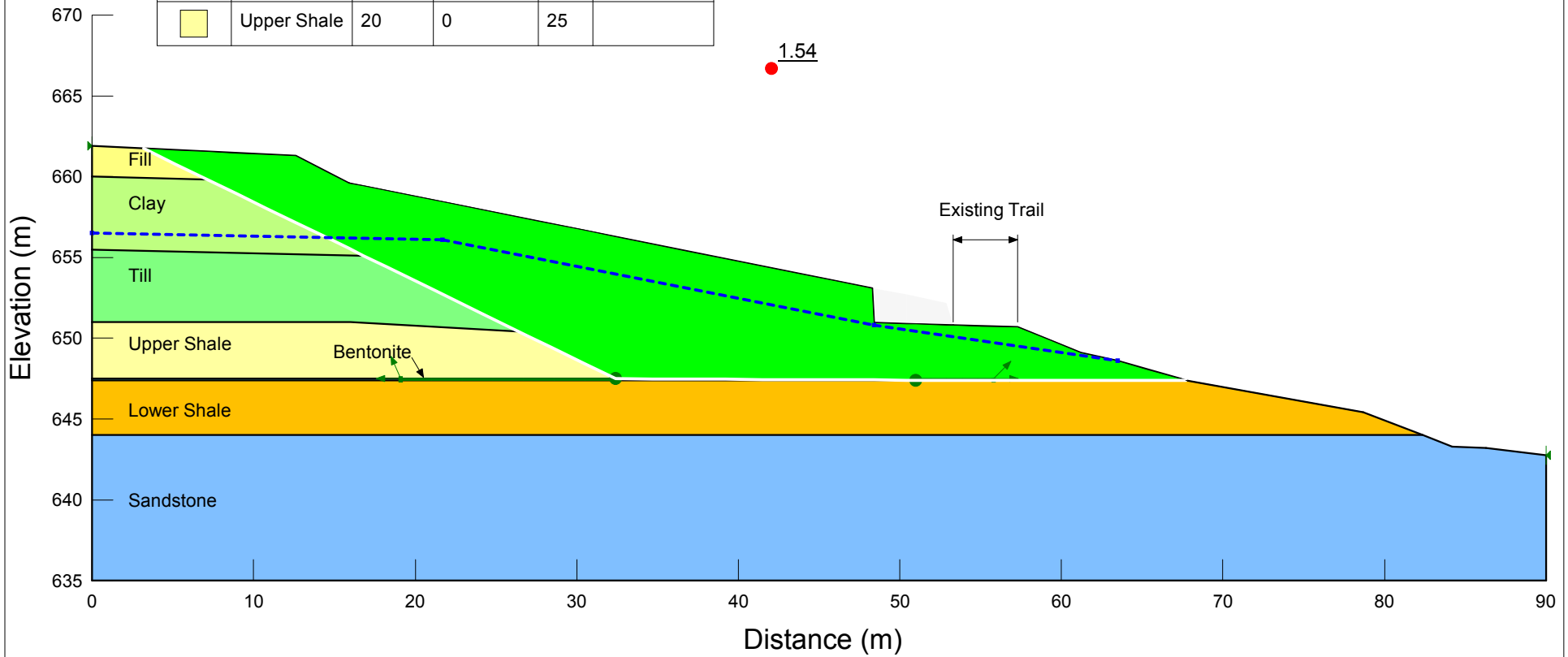

Color	Name	Unit Weight (kN/m ³)	Cohesion' (kPa)	Phi' (°)	Cohesion (kPa)	Piezometric Line
	Bentonite	18	0	14		
	Clay	19			25	1
	Clay Till	20			40	1
	Lower Shale	20			100	
	Upper Shale	20			50	

Figure G.7
 Cross-Section A
 Option 1: Short Radius
 Vertical Cut Slope





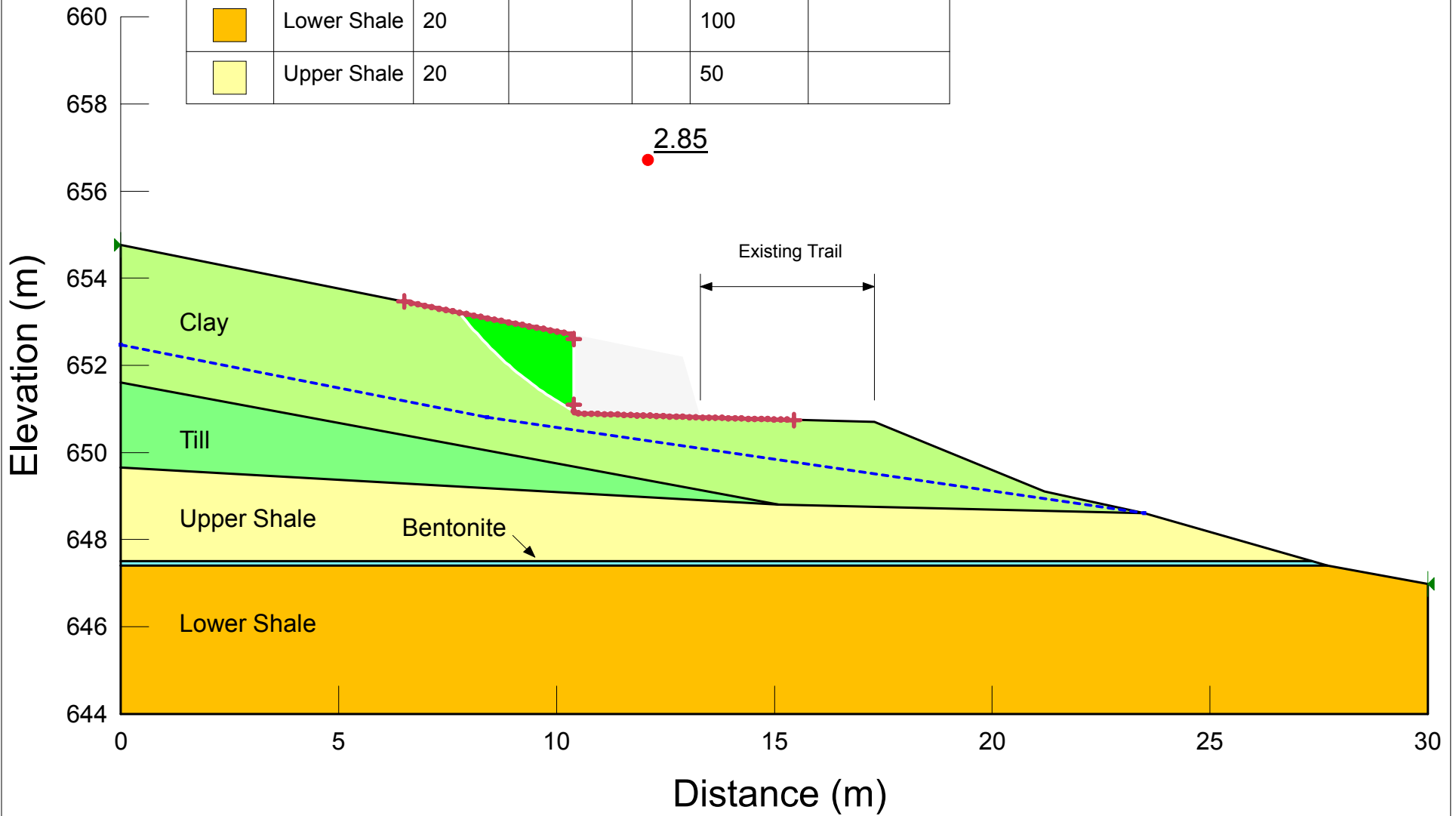

Color	Name	Unit Weight (kN/m ³)	Cohesion' (kPa)	Phi' (°)	Cohesion (kPa)	Piezometric Line
	Bentonite	18	0	14		
	Clay	19			25	1
	Clay Till	20			40	1
	Lower Shale	20			100	
	Upper Shale	20			50	

Figure G.8
 Cross-Section A
 Option 1: Short Radius
 1H:1V Cut Slope





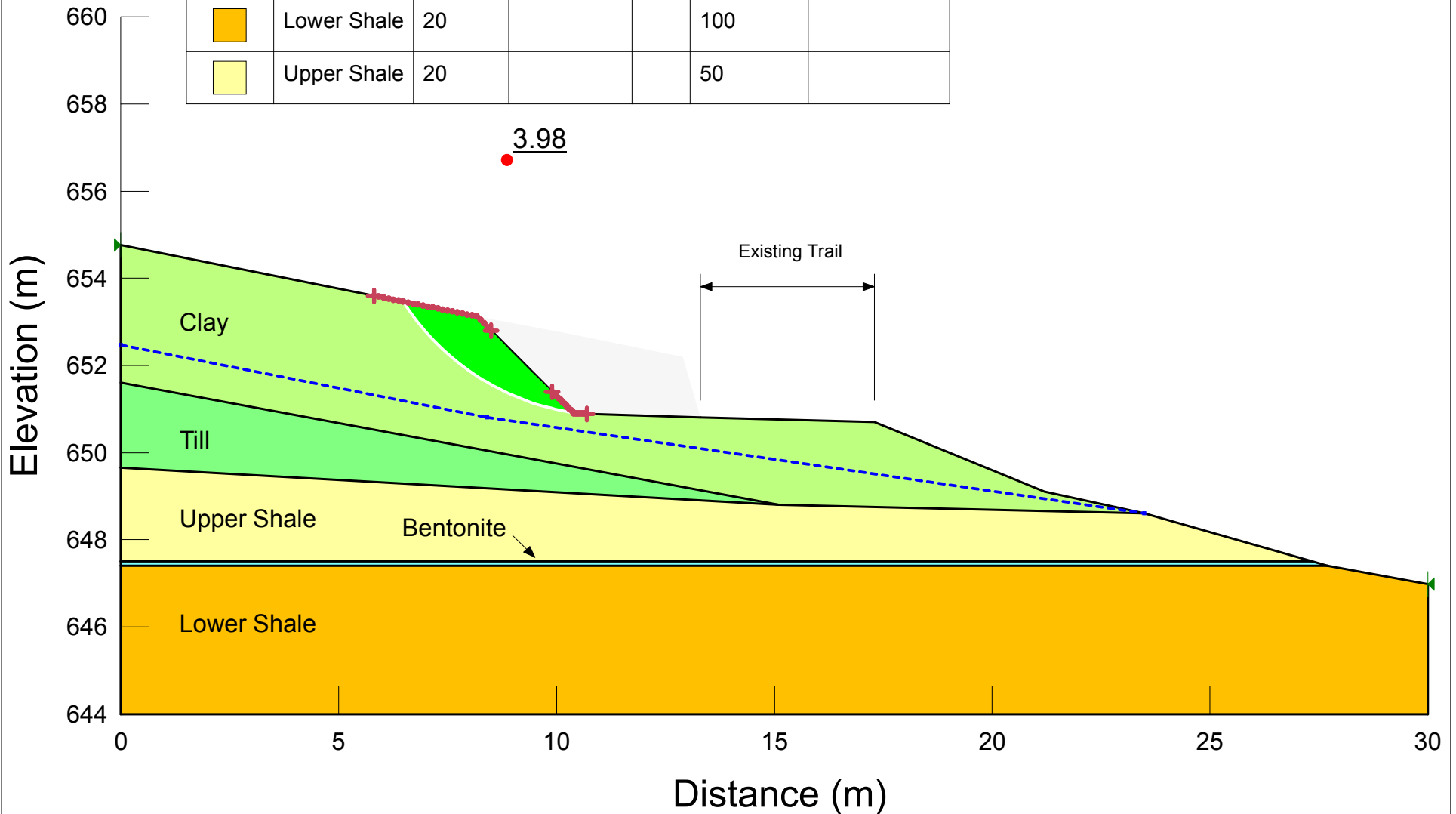

Color	Name	Unit Weight (kN/m ³)	Cohesion' (kPa)	Phi' (°)	Cohesion (kPa)	Piezometric Line
	Bentonite	18	0	14		
	Clay	19			25	1
	Clay Till	20			40	1
	Lower Shale	20			100	
	Upper Shale	20			50	

Figure G.9
 Cross-Section A
 Option 2: Long Radius
 Vertical Cut Slope





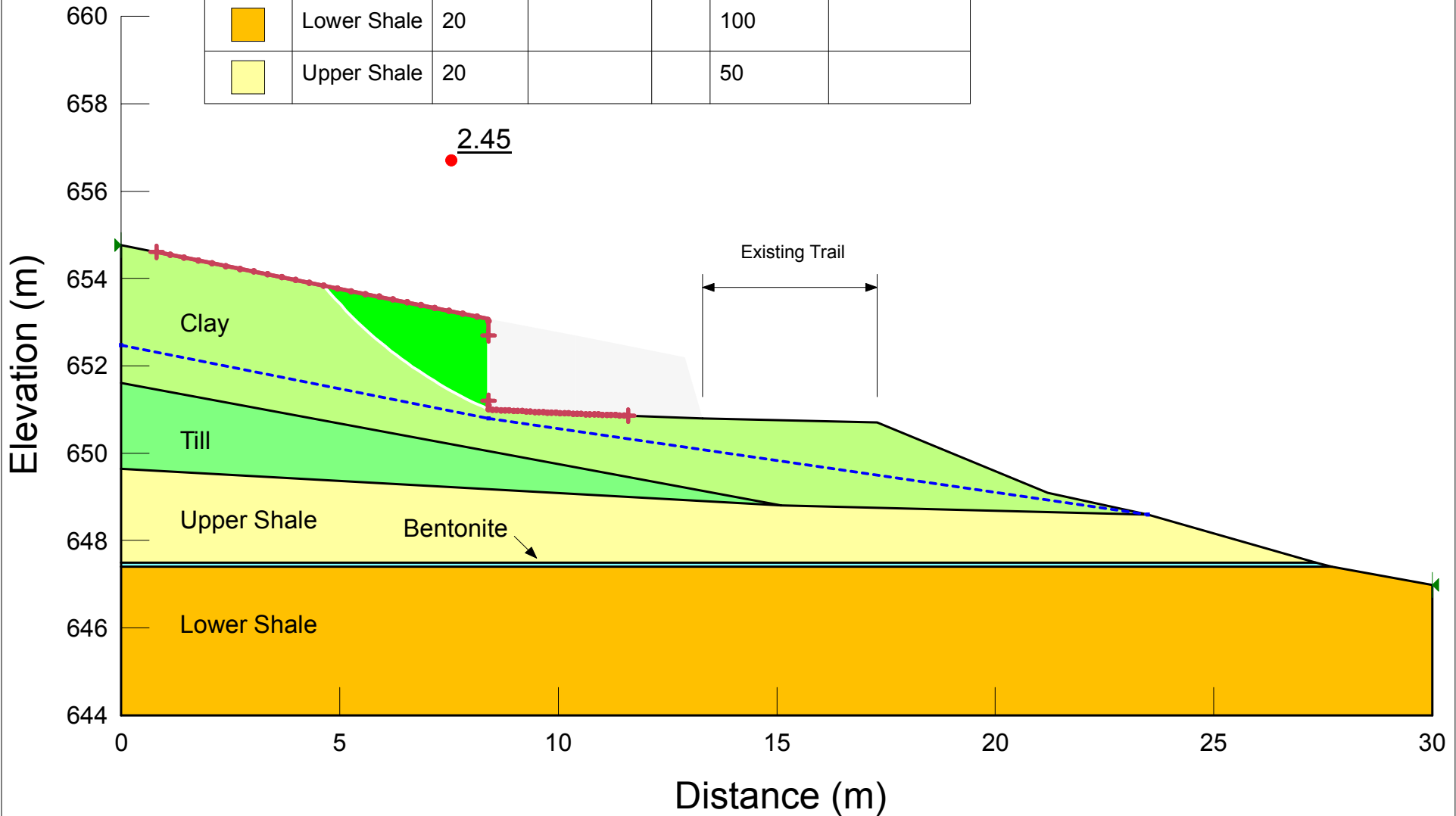

Color	Name	Unit Weight (kN/m ³)	Cohesion' (kPa)	Phi' (°)	Cohesion (kPa)	Piezometric Line
	Bentonite	18	0	14		
	Clay	19			25	1
	Clay Till	20			40	1
	Lower Shale	20			100	
	Upper Shale	20			50	

Figure G.10
 Cross-Section A
 Option 2: Long Radius
 1H:1V Cut Slope



Color	Name	Unit Weight (kN/m ³)	Cohesion' (kPa)	Phi' (°)	Piezometric Line
■	Bentonite	18	0	14	
■	Clay	19	0	20	1
■	Lower Shale	20	50	25	
■	Sandstone	21	20	35	
■	Upper Shale	20	0	25	

Figure G.11
Cross-Section B
Existing Geometry
Steep Bank

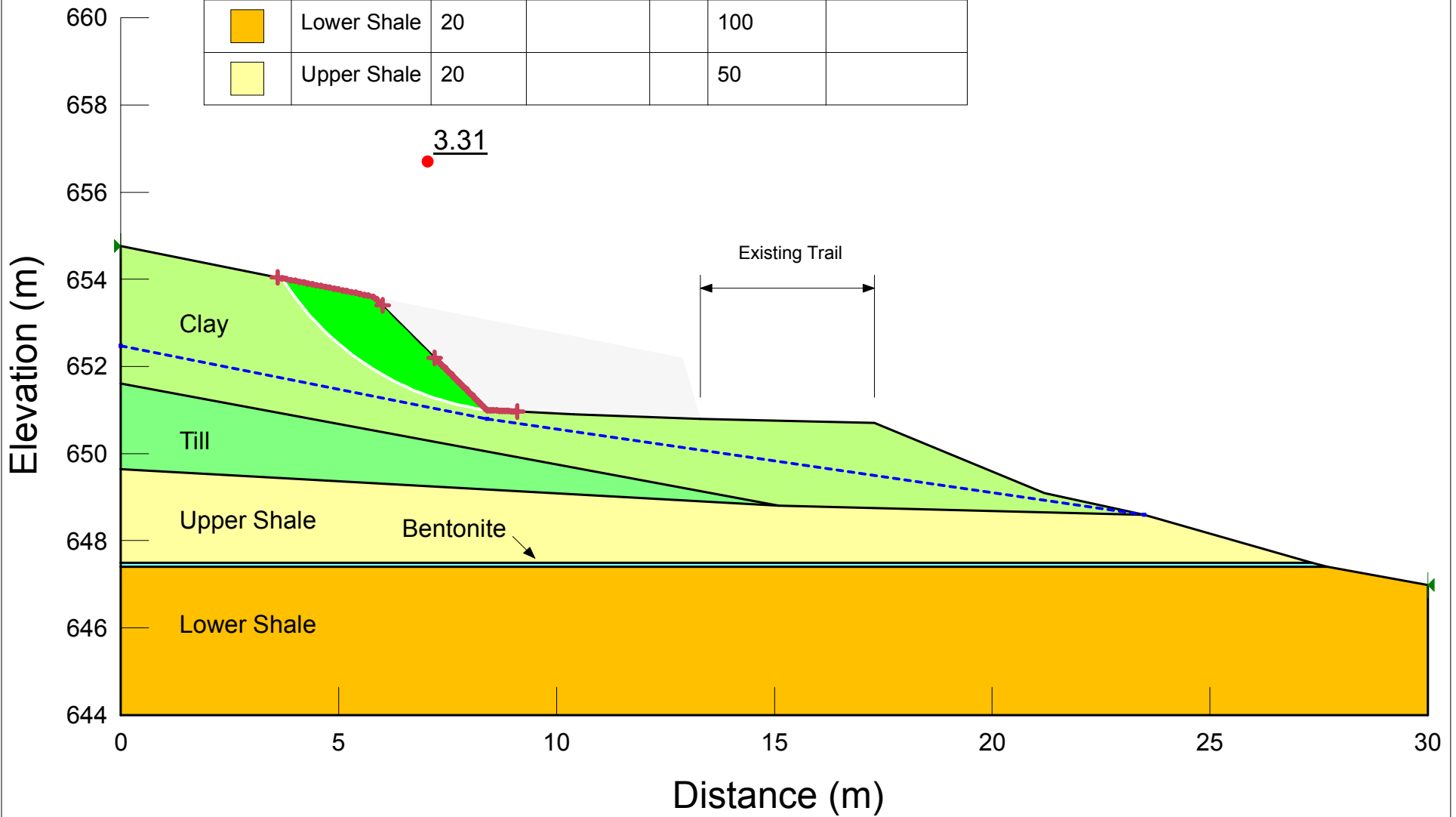